

## 16. Erosion and Sediment Control

---

- 16.1. Erosion and Sediment Control Policies
  - 16.2. Factors Influencing Erosion
  - 16.3. Technical Principles
  - 16.4. Guidance for Controlling Erosion
  - 16.5. Erosion and Sediment Control Plan
  - 16.6. Storm Water Pollution Prevention Plan
  - 16.7. Control Measures and Practices
  - 16.8. Revegetation
  - 16.9. References
- Appendix A: Erosion Control Practices (BMPs)  
Appendix B: Seed Selection Tables  
Appendix C: Soil Erodibility

### 16.1. Erosion and Sediment Control Policies

Erosion and sedimentation are natural processes whereby soil materials are detached and transported from one location and deposited in another, primarily due to rainfall and runoff. Accelerated erosion and sedimentation can occur in conjunction with highway and transportation facility construction. This accelerated process can result in significant detrimental impacts such as safety hazards, expensive maintenance problems, unsightly conditions, instability of slopes, water quality problems, and disruption of ecosystems. For this reason, the designer must consider minimization of erosion and sedimentation throughout the design process.

#### 16.1.1 Federal Policy

As a result of the 1972 amendments to the Federal Water Pollution Control Act (known as the Clean Water Act or CWA), much attention has been directed to the control of erosion and sedimentation. As a result, numerous state and federal regulations and controls governing earth-disturbing activities have been developed and published. Federal policy for erosion and sediment control for all construction projects that are funded at least in part under Title 23, U.S. Code is set forth in 23CFR650 Subpart B, which states that all such construction projects shall:

“... be located, designed, constructed and operated according to standards that will minimize erosion and sediment damage to the highway and adjacent properties, and abate pollution of surface and ground water resources.”

Within this Subpart, the Federal Highway Administration (FHWA) adopts the American Association of State Highway and Transportation Officials (AASHTO) Highway Drainage Guidelines, Volume III, Erosion and Sediment Control in Highway Construction, 1992. Other federal control requirements include:

- River and Harbor Act, Sections 9 and 10
- Coastal Zone Act Reauthorization Amendments of 1990, Section 6217(g)
- Guidance Specifying Management Measures for Sources of Nonpoint Pollution in Coastal Waters, 84-B-92-002, U.S. EPA, January, 1993
- Issuance of the Storm Water General Permit for Large and Small Construction Activities, EPA, 2003

#### 16.1.2 AASHTO Policy

The policy for erosion and sediment control is stated in the AASHTO publication, "A Policy on Geometric Design of Rural Highways," as follows:

"Erosion prevention is one of the major factors in the design, construction and maintenance of highways. Erosion can be controlled to a considerable degree by geometric design particularly relating to the cross section. In some respects the Erosion and Sediment Control Policies control is directly associated with proper provision for drainage and fitting landscape development. Effect on erosion should be considered in the location and design stages."

"Erosion and maintenance are minimized largely by the use of flat side slopes, rounded and blended with natural terrain; drainage channels designed with due regard to width, depth, slopes, alignment and protective treatment; located and spaced facilities for ground water interception; dikes, berms and other protective devices; and protective ground covers and planting."

Although some standardization of methods for minimizing soil erosion in highway construction is possible, national guidelines for the control of erosion are of a general nature because of the wide variation in climate, topography, geology, soils, vegetation, water resources, and land use encountered in different parts of the country.

### **16.1.3 State Policy**

In order to comply with federal policies, the Alaska Department of Transportation and Public Facilities (DOT&PF) has adopted the AASHTO Guidelines discussed above.

For all projects with disturbed earth, the Contractor must develop a Storm Water Pollution Prevention Plan (SWPPP) and the Project Engineer must approve it. However, the designer must provide sufficient information and guidance through the contract documents to ensure a well-conceived, economically justified SWPPP. This guidance, termed the Erosion and Sediment Control Plan (ESCP), is preferably provided as a stand-alone document inserted into the advertised contract documents. The ESCP may be incorporated into the plan sheets for small-scale projects. The level of effort required to develop an ESCP and implement a SWPPP will be commensurate with the complexity of the project's earth-disturbing activities and the potential detrimental impacts to receiving waters. Sections 16.5 and 16.6 discuss specific requirements for ESCPs and SWPPPs.

ESCPs may be prepared by a qualified person(s) (i.e. design engineer, regional hydraulic engineer, environmental analyst or consultant), but the ESCP plan sheets must be stamped by an Alaska-registered Professional Engineer. Regional Hydraulic Engineers should review all ESCPs for adequacy.

### **16.1.4 Program**

All permanent erosion and sediment control measures will be included in the project's items of work and presented as individual bid items, where reasonable. The ESCP will specifically address temporary measures that will also serve as permanent measures.

Since highway construction may involve the disturbance of large land areas, control of erosion and sedimentation is a major concern. A commitment to erosion and sediment prevention and control is essential during all phases of highway design, construction, and maintenance. While much of the effort for control of erosion and sedimentation is expended during the construction phase of a highway development, a successful ESC program must address erosion and sedimentation during the planning, location, design, and future maintenance phases as well. The erosion and sediment control program should be a plan of actions and should include contract documents to achieve an acceptable level of control within established criteria and control limits.

This plan of action is analogous to an agency's highway development process, which results in contract plans and documents to provide and maintain transportation facilities based on certain criteria and controls. Before the Department develops a project's ESCP, the Department's project development process will include and account for the following:

- During the environmental scoping process, the project environmental analyst will identify sediment sensitive receiving areas. These areas are Waters of the United States, including wetlands, as defined by the 1987 Edition, Federal Manual for Identifying Jurisdictional Wetlands. The plans and/or specifications will identify the sediment sensitive receiving areas. Generally, these areas will be represented on the plan sheets.
- The design engineer will use highway geometrics to minimize soil erosion and sedimentation problems where practicable and feasible when setting final alignment.
- The hydrology and hydraulics report will characterize the drainage issues for the project.
- The geotechnical report will characterize the erodibility of soils anticipated to be exposed or imported for construction materials.

### **16.1.5 Guidelines**

The design of erosion and sediment control systems involves the application of common sense planning, scheduling, and control actions that will minimize the adverse impacts of soil erosion, transport, and deposition. The following basic guidelines govern the development and implementation of a sound erosion and sediment control plan.

- Plan the project to take advantage of the topography, soils, waterways, and natural vegetation.
- Expose the smallest practical area for the shortest possible time.
- Apply on-site erosion control measures to reduce the erosion from the site.
- Use sediment control measures to prevent off-site detrimental impacts whenever primary on-site erosion control measures are insufficient.
- Implement a thorough maintenance and follow-up program.

### **16.1.6 Control Measures**

In practice, these guidelines should be tied together in the design process, which identifies potential erosion and sediment control problems before construction begins. Control measures such as stabilizing emulsions and vegetation are required for all disturbed areas. Vegetation measures generally include retention or provision of strips of vegetation to provide a filtration buffer, temporary seeding, permanent seeding, sodding, and mulching. Structural control measures are required when potentially damaging sediment laden runoff leaves a disturbed site, and they generally include sediment traps, diversions, sediment basins, and permanent drainage facilities. Erosion and sediment control measures are commonly termed “Best Management Practices” (BMPs) in a variety of texts and publications.

## **16.2. Factors Influencing Erosion**

The inherent erosion potential of any area is determined by four principal factors: soil characteristics; vegetative cover; topography, and climate. Although each of these factors is discussed separately herein, they are interrelated in determining erosion potential.

### **16.2.1 Soil Characteristics**

The properties of soil that influence erosion by rainfall and runoff are those affecting the infiltration capacity of a soil and those affecting the resistance of a soil to detachment and being carried away by falling or flowing water. Soils containing high percentages of fine sands and silt are normally the most erodible. As the clay and organic matter content of these soils increases, the erodibility decreases. Clays act as a binder to soil particles, thus reducing erodibility. However, while clays have a tendency to resist erosion, once eroded they are easily transported by water. Soils high in organic matter have a more stable structure, which improves their permeability. Such soils resist raindrop detachment and infiltrate more rainwater. Clear, well-drained and well-graded gravels and gravel-sand mixtures are usually the least erodible soils. Soils with high infiltration rates and permeabilities reduce the amount of runoff.

### **16.2.2 Vegetative Cover**

Vegetative cover plays an important role in controlling erosion in the following ways:

- shields the soil surface from raindrop impact
- holds soil particles in place
- maintains the soil's capacity to absorb water
- slows the velocity of runoff
- removes subsurface water between rainfalls through the process of evapotranspiration

By limiting and staging the removal of existing vegetation, and by decreasing the area and duration of exposure, soil erosion and sedimentation can be significantly reduced. Special consideration should be given to the maintenance of existing vegetative cover on areas of high erosion potential, such as erodible soils, steep slopes, drainage ways, permafrost areas, and stream banks.

### **16.2.3 Topography**

The size, shape, and slope characteristics of a watershed influence the amount and rate of runoff. As both slope length and gradient increase, the rate of runoff increases and the potential for erosion is magnified. Slope orientation can also be a factor in determining erosion potential.

### **16.2.4 Climate**

The frequency, intensity, and duration of rainfall are fundamental factors used for estimating the amounts of runoff produced in a given area. As both the volume and velocity of runoff increase, the capacity of runoff to detach and transport soil particles also increases. Where storms are frequent, intense, or of long duration, erosion risks are high. Seasonal changes in temperature, as well as variations in rainfall, help to define the high erosion risk period of the year. When precipitation falls as snow, no erosion will take place. However, in the spring the melting snow adds to the runoff, and erosion hazards are high. Because the ground is still partially frozen, its absorptive capacity is reduced. Frozen soils are relatively erosion-resistant. However, soils with high moisture content are subject to uplift by freezing action and are usually very easily eroded upon thawing. Extreme erosion potential can occur when the vegetative mat is removed in permafrost areas.

### **16.3. Technical Principles**

For an erosion and sediment control program to be effective, the designer must consider it and provide for appropriate measures during the project environmental and design stages. These planned measures, when conscientiously and expeditiously applied during construction as part of the Contractor's Storm Water Pollution Prevention Plan (SWPPP), will result in orderly development with minimal environmental degradation. From the previous discussion about erosion and sedimentation processes and the factors affecting erosion, basic technical principles can be formulated to assist the designer in providing for effective control of erosion and sediment. The hierarchy of principles employed in order of preference are: avoidance, minimization, and lastly, active measures. Use the following principles to the maximum extent possible on all projects.

#### **16.3.1 Avoidance**

Plan the highway project to fit the particular topography, soils, drainage patterns, and natural vegetation as much as practicable. Map all surface waters, natural drainage ways, and direction of drainage patterns. Identify and avoid areas with steep slopes, erodible soils, and soils with severe limitations when possible.

#### **16.3.2 Minimization**

Minimize the extent and the duration of exposure. Plan the phases or stages of construction to minimize exposure. Complete grading as soon as possible after it is begun. Establish permanent vegetative cover immediately after grading is complete.

#### **16.3.3 Active Measures**

##### **Erosion Control**

Apply erosion control practices (BMPs) to prevent excessive on-site damage. This third principle relates to using practices that control erosion on a site to prevent excessive sediment from being produced. Keep soil covered as much as possible with temporary or permanent vegetation or with various mulch or mat materials. You may use special grading methods such as roughening a slope on the contour or tracking with a cleated dozer. Other practices include diversion structures to divert surface runoff from exposed soils and grade stabilization structures to control surface water. "Gross" erosion such as gullies must be prevented by these water control devices.

##### **Sedimentation Control**

Apply perimeter control practices (BMPs) to protect the disturbed area from off-site runoff and to prevent sedimentation damage to areas below the construction site. This principle relates to using practices that effectively isolate the construction site from surrounding properties, and especially to controlling sediment once it is produced and preventing its transport from the site. Diversions, dikes, sediment traps, and vegetative and structural sediment control measures are classified as either temporary or permanent, depending on whether or not they will remain in use after construction is complete.

Generally, you can retain sediment by two methods: (a) filtering runoff as it flows through an area and (b) impounding the sediment-laden runoff for a period of time so that the soil particles settle out. The best way to control sediment, however, is to prevent erosion.

##### **Velocity Control**

Keep runoff velocities low and detain runoff on the site. The removal of existing vegetative cover and the resulting decrease in retention time during construction will increase both the volume and velocity of runoff. Take these increases into account when providing for erosion control. Keeping slope lengths short and gradients low and preserving natural vegetative cover can keep storm water velocities low and limit erosion hazards. You should safely convey runoff from developed areas to a stable outlet using storm drains, diversion structures/techniques, stable waterways, or similar measures. Design conveyance systems to withstand the velocities of projected peak discharges, and make these facilities operational as soon as possible.

##### **Stabilization**

Stabilize disturbed areas immediately after final grade has been attained. Employ permanent structures, temporary or permanent vegetation, mulch, stabilizing emulsions, or a combination of these measures, as quickly as possible after the land is disturbed. Temporary vegetation and mulches and other control materials can be most effective when it is not practical to establish permanent vegetation or until the vegetation is established. Use such temporary measures immediately after rough grading is completed, if you anticipate a delay in obtaining finished grade. In the design, consider the stability and ease of maintenance for the finished slope of a cut or fill. Stabilize roadways, parking areas, and paved areas with a gravel sub-base whenever possible.

## Maintenance

Implement a thorough maintenance and follow-up program. Maintenance is vital to the success of active measures. A construction site cannot be effectively controlled without thorough, periodic checks of the erosion and sediment control practices. Just as with construction equipment, you must maintain control practices and check and inventory material. Provide detailed requirements for the maintenance and follow-up program in the contract specifications.

Usually, avoidance, minimization, and active measures are integrated into a system of vegetative and structural measures coupled with management techniques to develop a plan to prevent erosion and control sediment. In most cases, a combination of limited time of exposure and a judicious selection of erosion control practices and sediment trapping facilities will prove to be the most practical method of controlling erosion and the associated production and transport of sediment.

## 16.4. Guidance for Controlling Erosion

Using the principles of avoidance, minimization and finally, active measures, consider the following guidance as minimum requirements for controlling erosion and sedimentation from earth-disturbing activities. These general criteria work in concert with individually developed erosion and sediment control plans.

### Stabilization

The following refers to stabilization of denuded areas and soil stockpiles.

Apply permanent or temporary soil stabilization to denuded areas as soon as possible, but always within 15 days after final grade is reached on any portion of the site. Apply soil stabilization within 15 days to denuded areas that may not be at final grade but will remain dormant (undisturbed) for longer than 45 days.

- Soil stabilization refers to measures that protect soil from the erosive forces of raindrop impact and flowing water. Wind may also become a factor in soil stabilization. Applicable practices include the use of temporary erosion control material, vegetative establishment, mulching, and the early application of a gravel base on areas to be paved. Select soil stabilization measures that are appropriate for the time of year, site conditions, and estimated duration of use.

- Stabilize or protect erodible soil stockpiles with sediment trapping measures to prevent soil loss. If stockpiles are small, you may cover them with tarps, etc.

### Perimeter Controls

You should protect properties and receiving waters adjacent to the site of a land disturbance from sediment deposition. Protective measures include (1) preserving a well-vegetated buffer strip around the lower perimeter of the land disturbance (2) installing perimeter controls such as sediment barriers, filters, dikes, or sediment basins, or (3) a combination of such measures.

### Timing and Stabilization

Construct sediment basins and traps, perimeter dikes, sediment barriers, and other measures intended to trap sediment on-site as a first step in grading, and make them functional before upslope land disturbance takes place. Seed and mulch earthen structures such as dams, dikes, and diversions within 15 days of installation.

### Sediment Basins

Storm water runoff from drainage areas with more than 5 acres disturbed area should pass through a sediment basin or other suitable sediment trapping facility. Sediment basins are more cost effective when most of the area draining to the basin is disturbed area, since their size must be based on total contributing area. Appropriately sized and stabilized conveyance channels will normally be required to funnel runoff to the basins.

### Cut and Fill Slopes

Design and construct cut and fill slopes to minimize erosion. Consider the length and steepness of the slope, the soil type, upslope drainage area, groundwater conditions, and other applicable factors. The following guidelines will aid site designers and plan reviewers in developing an adequate design.

- Roughened soil surfaces are generally preferred to smooth surfaces on slopes.
- Construct diversions at the top of long steep slopes that have significant drainage areas above the slope. You may also use diversions or terraces to reduce slope length.
- Do not allow concentrated storm water to flow down cut or fill slopes unless contained

within an adequate temporary or permanent channel, flume, or slope drain structure.

- Wherever a slope face crosses a water seepage plane that endangers the stability of the slope, provide adequate subsurface drainage or other protection. A geotechnical investigation should provide recommendations to the designers for this situation.

### **Waterways and Outlets**

Design and construct all on-site temporary storm water conveyance channels to withstand the expected velocity of flow from a 2-year frequency storm with minimum erosion. Design permanent measures for a 10-year frequency storm. Provide erosion control measures such as energy dissipaters at the outlets of all pipes and paved channels.

### **Inlet Protection**

Protect all storm drain inlets made operable during construction, so that sediment-laden water will not enter the conveyance system without first being filtered or otherwise treated to remove sediment.

### **Crossing Watercourses**

Keep construction vehicles out of watercourses as much as possible. Where in-channel work is necessary, stabilize the work area during construction to minimize erosion. Always restabilize the channel (including bed and banks) immediately after in-channel work is completed. Where an active (wet) watercourse must be crossed by construction vehicles regularly during construction, provide a temporary stream crossing. You may need environmental permits for in-water work.

### **Disposition of Measures**

Dispose of all temporary erosion and sediment control measures within a specified time after final site stabilization or after the temporary measures are no longer needed. To prevent further erosion and sedimentation, permanently stabilize trapped sediment and other disturbed soil areas resulting from the disposition of temporary measures.

### **Maintenance**

Maintain and repair all temporary and permanent erosion and sediment control practices as needed to assure continued performance of their intended function.

## **16.5. Erosion and Sediment Control Plan**

### **16.5.1 Definition and Overview**

Simply stated, an Erosion and Sediment Control Plan (ESCP) is a document that illustrates measures to control erosion and sediment problems on a project. The plan consists of maps and/or site plans. Written descriptions or narratives may be provided when needed to clarify the ESCP. DOT&PF prepares the plan, including standards and specifications, and includes it as part of the contract documents. The ESCP provides bidders a basis for cost estimating, and it ultimately provides the awarded Contractor information and guidance for developing an acceptable Storm Water Pollution Prevention Plan (SWPPP).

The ESCP provides a practicable plan, while giving the Contractor enough latitude to develop a sequence of operations based on season, site conditions, personnel, and equipment. For example: a simple overlay project may require only a short description in the specifications; the ESCP for a project with a small amount of disturbance could completely specify all measures; while an ESCP for a project with a complex sequence of earth-disturbing activities may have to be limited to locating preliminary control measures and measures at final grade, leaving the interim measures to be developed in the Contractor's SWPPP. It is important, however, for the ESCP to provide the Contractor with sufficient information such as appropriate control measures, problem areas, areas identified in permits, timing limitations, and specifications.

An ESCP narrative describes the erosion and sediment control plan and identifies the assumptions and the reasoning for particular recommendations or requirements. The narrative is important to the Project Engineer, inspectors, and Contractors responsible for implementing an approved SWPPP.

The length and complexity of the plan should be commensurate with the size of the project, the severity of site conditions, the erosion and sedimentation risks, and the potential for off-site damage.

### **16.5.2 Plan Development Procedures**

#### **Step 1 - Data Collection and Preliminary Analysis**

The highway construction plans can serve as the base map for the ESCP. If available, obtain a soils map from the local office of the USDA Natural Resource Conservation Service. The designer responsible for

the plan should inspect the site to verify natural drainage patterns, drainage areas, general soil characteristics, and off-site factors. It is important that this review occur at the beginning of the design phase to avoid loss of time and resources on developing impractical alternatives.

The base data should consider such characteristics as:

- receiving waters (Waters of the U.S.)
- land slopes
- natural drainage patterns
- unstable stream reaches
- flood marks
- watershed areas
- existing vegetation (noting special vegetative associations)
- critical areas such as steep slopes, eroding areas, rock outcroppings, and seepage zones
- property and unique or noteworthy landscape values to protect or avoid
- adjacent land uses - especially areas sensitive to sedimentation or flooding
- critical or highly erodible soils that should be left undisturbed

In the analysis of these data, identify:

- right-of-way requirements
- buffer zones
- areas of steep natural and man-made slopes
- stream crossing areas
- access routes for construction and maintenance of sedimentation control devices
- state-provided borrow and waste disposal areas
- the most practical sites for control practices
- potential for sediment pollution of adjacent water courses and properties

When all of the data are considered together, a picture of the site potentials and limitations should begin to emerge. The designer should be able to determine those areas that have potentially critical erosion hazards. Appendix C describes soil erodibility by type and slope.

### Step 2 - Design of Erosion And Sediment Control Plan

We recommend the following general procedure for erosion and sediment control design.

1. Determine limits of clearing and grading. Pay special attention to critical areas that must be disturbed and areas where vegetation can be left intact.
2. Divide the site into drainage areas. Determine how runoff will travel over the site during construction. Consider how erosion and sedimentation can be controlled in each small drainage area before looking at the entire site. Remember, it is easier to control erosion than to contend with sediment after it has been carried downstream.
3. Select erosion and sediment control practices (BMPs). These practices are divided into 3 broad categories: erosion prevention, sedimentation control, and management measures. Management measures are construction management techniques that, if properly utilized, can minimize the need for physical controls and possibly reduce costs.
  - a. Erosion Prevention Measures - The first line of defense is to prevent erosion by protecting the soil surface from raindrop impact and overland flow of runoff. The best way to protect the soil surface is to preserve the existing ground cover. Where land disturbance is necessary, use temporary seeding, mulching, or other erosion control measures on areas that will be exposed for long periods of time. Temporary seeding may be impractical in certain Alaskan climatic regions.

Erosion and sediment control plans should contain provisions for permanent stabilization of disturbed areas. Consider the following when selecting permanent vegetation:

    - availability and practicality of native species
    - establishment requirements
    - adaptability to site conditions
    - aesthetics
    - maintenance requirements
  - b. Sedimentation Controls - Structural practices are used mainly to control eroded material. They are generally more costly and less efficient than erosion control measures.

However, they are usually necessary, since not all disturbed areas can be completely protected. They are often used as a second or third line of defense to capture sediment before it leaves the site. It is very important that structural practices be selected, designed, and installed according to the contract standards and specifications. Improper use or inadequate installation can create problems that are greater than the structure was designed to solve.

Structural controls also include the permanent drainage facilities. The Contractor must construct these as early as possible.

- c. Management Measures - Good construction management is as important as physical practices for erosion and sediment control, and there is generally little or no cost involved. Discuss pertinent issues within the ESCP. The Contractor should specifically address these issues in the Storm Water Pollution Prevention Plan. Management considerations include:
- Sequence construction so that no area remains exposed for unnecessarily long periods of time (e.g. 15 days).
  - Notify the seeding Contractor in advance to avoid delays in seeding once slopes are prepared.
  - Where practicable, perform temporary seeding immediately after grading.
  - On large projects, stage the construction, if possible, so that one area can be stabilized before another is disturbed.
  - Develop and carry out a regular maintenance schedule for erosion and sediment control practices.
  - Make sure that key workers understand the major provisions of the erosion and sediment control plan.
  - Designate responsibility for implementing the erosion and sediment control plan to one individual.

### Step 3 - Prepare the Plan

The final step consists of consolidating the pertinent

information and developing it into a specific erosion and sediment control plan for the project, using maps and plan sheets. As discussed in Section 16.5.1, you may supplement the plan with a narrative if necessary to verbally explain specific problems and their solutions.

For complex projects, you may need to key individual plan sheets to a master plan sheet to show the general erosion and sediment control requirements for the entire project.

Include in the ESCP, as far as practicable, the items listed in Sections 16.6.3 and 16.6.4. Those items we consider to be a minimum for the ESCP are denoted by an (\*).

### Step 4 – Have the Plan Reviewed by the Regional Hydraulics engineer.

## **16.6. Storm Water Pollution Prevention Plan**

### **16.6.1 Description**

The Storm Water Pollution Prevention Plan (SWPPP) is the detailed site-specific plan prepared by the Contractor for the temporary and permanent control of erosion and sedimentation during project construction. The SWPPP is based upon the ESCP, and when approved, replaces the ESCP. If the project disturbs more than **1 acre** of ground, the SWPPP is prepared according to the requirements of the National Pollutant Discharge Elimination System Storm Water General Permit for Large and Small Construction Activities. Specific direction for the development of the SWPPP is given in DOT&PF's "Storm Water Pollution Prevention Plan Guide" (SWPPP Guide)

### **16.6.2 SWPPP**

The Contractor must prepare the SWPPP, which must address all earth-disturbing activities designated by the contract, including off-site support activities. The Department will review the Contractor's draft SWPPP and either approve it or recommend changes. The Contractor will make the necessary revisions to obtain the Department's approval. The approved SWPPP must be signed by the Contractor and the Department in accordance with the NPDES General Permit. The approved SWPPP is not intended to be a rigid document. It must be amended as necessary to address unanticipated or emergency conditions to maintain water quality.



DOT&PF's "Storm Water Pollution Prevention Plan Guide" (SWPPP Guide) and the NPDES Storm Water General Permit for Large and Small Construction Activities give detailed descriptions of the required contents of the SWPPP. The SWPPP must follow the format presented below and address all storm water discharge control and management issues identified in the ESCP. The SWPPP shall include the following:

### 16.6.3 Site Description

The site description should contain the following information:

- Description of the nature and extent of the construction activity (\*).
- Description of the intended sequence of major earth-disturbing activities, such as grubbing, excavation, grading, or utility installation.
- Estimates (to the nearest quarter acre) of the total area of the project site (including related off-site areas such as borrow pits, waste areas, etc.) and the total area that is expected to be disturbed (\*).
- Name and description of the storm water discharge receiving waters (\*). These areas are Waters of the United States including wetlands as defined by the 1987 Edition, Federal Manual for Identifying Jurisdictional Wetlands. This also includes the extent and description of wetlands or special aquatic sites at or near the project site that will be disturbed or receive storm water discharge from disturbed areas of the site.
- A general location map and a site map showing the following:
  - a. drainage patterns (\* projects > 1 acres)
  - b. approximate slopes after grading (\*projects > 1 acres)
  - c. areas of soil disturbance and undisturbed areas (\*)
  - d. location of major structural and nonstructural controls identified in the SWPPP (\*) (Note: Contractor may modify the Department's proposed controls).
  - e. location of areas where stabilization is expected to occur (\*). (Note: ESCP may identify such areas, but locations are often

dependent on the Contractor's methodology.)

- e. location of surface waters (including wetlands and all waters that will pass through the project site), and locations where storm water is discharged to a surface water (\*)
  - f. location of any impaired waters or waters with approved and final Total Maximum Daily Loads (TMDLs) for Alaska (\*).
  - g. location of all off-site material, waste, borrow or equipment storage areas. (Note: ESCP will identify state-designated material sites and disposal sites.)
- Location and description of any discharge associated with industrial activity other than construction, and location of storm water discharges from dedicated asphalt or concrete plants covered by this permit.
  - If disturbed area is greater than 1 acre, include a copy of the NPDES General Permit requirements as an appendix to the SWPPP.
  - If disturbed area is greater than 1 acre, information on whether listed threatened or endangered species, or their critical habitat, are found in proximity to the project (\*) and off-site support areas, and whether such species or habitat may be affected by pollutants in storm water discharges or related activities. (Note: Contractor is responsible for their off-site material and disposal areas).
  - If disturbed area is greater than 1 acre, information on historic sites, including (1) whether any sites listed on the National Register of Historic Places may be affected by storm water discharges, and (2) whether any agreement is in place with the state historic preservation officer (\*). (Note: Contractor is responsible for their off-site material and disposal areas).

(\*): minimum information to be contained in ESCP

In addition, include a copy of the signed and certified Notice of Intent (NOI) form that was submitted to

EPA. Upon receipt, include a copy of the electronic mail message or letter from EPA Storm Water Notice Processing Center notifying the applicant of receipt of the administratively completed NOI.

#### **16.6.4 Control Measures**

The SWPPP must include a description of appropriate control measures to be implemented as part of the construction activities to control pollutants in storm water discharges.

The SWPPP must clearly describe, for each major earth-disturbing activity described above, the appropriate control measures and the general timing (or sequence) during the construction process that the measures will be implemented, and who (Contractor or Subcontractor) will be responsible for implementation. The description and implementation of the controls shall address the following minimum components:

##### **1. Erosion Control Practices**

A plan view or description of interim and permanent measures such as the preservation of vegetative cover, temporary and permanent vegetation establishment, mulching, geotextiles, etc. shall be included.

The following records shall be maintained and attached to the SWPPP or be accessible in the Project Engineer's office:

- a. dates when major grading activities occur
- b. dates when construction activities cease on a portion of the site, either temporarily or permanently
- c. dates when stabilization measures are initiated

##### **2. Structural Practices**

A plan view or description of structural practices to divert flows from exposed soils, store flows, or otherwise limit runoff and discharges shall be included. Examples of structural practices include silt fences, earth dikes, drainage swales, sediment traps, check dams, subsurface drains, and temporary or permanent sediment basins.

##### **3. Storm Water Management**

A section shall include a description of measures that will be installed during construction to control sediment and pollutants in storm water discharges that will occur after construction operations. Examples include storm water

detention structures (wet ponds), storm water retention structures, flow attenuation, on-site filtration, and sequential systems. Permanent measures such as these will also be included in the Department's ESCP.

##### **4. Other Controls**

This section shall address measures to be used to minimize dust and off-site vehicle tracking of sediments; a description of any on-site material storage and measures to be used to minimize exposure of the materials to storm water; measures to be used for spill prevention and response; and a description of pollutant sources from areas other than construction and a description of controls. The SWPPP shall also include a description of measures necessary to protect listed endangered or threatened species or critical habitat.

#### **16.6.5 Maintenance**

All erosion and sediment control measures and other protective measures identified in the SWPPP must be maintained in effective operating condition. If the required inspections described in the following item identify a measure that is not operating effectively, maintenance shall be performed before the next anticipated runoff event, or as necessary to maintain continued effectiveness of the storm water controls. If maintenance prior to the next runoff event is impractical, maintenance must be scheduled as soon as practicable.

#### **16.6.6 Inspections**

Qualified personnel must inspect the following:

1. disturbed areas of the construction site that have not been finally stabilized
2. areas used for storage of erodible material exposed to precipitation and/or runoff
3. erosion prevention measures
4. structural control measures
5. locations where vehicles enter or exit the site

Inspections should occur at least once every 7 calendar days and within 24 hours of the end of a storm that produces 0.5 in or more rainfall over a 24-hour period. Based on the results of the inspection, the Contractor must modify the SWPPP as necessary to include additional or modified measures to correct identified problems. The Contractor must complete

the revisions within 7 calendar days following the inspections. If modifications are made to existing measures, the Contractor must implement the modification within 7 days of the inspection.

During winter shutdown, the Contractor must conduct inspections at least once every month and within 24 hours of the end of a storm that produces 0.5 in or more rainfall over a 24-hour period. The Contractor is eligible for a waiver of the monthly inspection requirements until one month before thawing conditions are expected to result in a discharge, if all of the following requirements are met:

- earth-disturbing activities have been suspended
- the project is located in an area where frozen conditions are anticipated to continue for extended periods of time (i.e. more than one month)
- the Contractor documents the beginning and end dates of the waiver period in the SWPPP

Contract specifications or special provisions may have different inspection requirements, depending on site-specific conditions.

## **16.7. Control Measures and Practices**

### **16.7.1 Introduction**

Appendix A is a discussion of the more commonly used erosion and sediment control practices (BMPs), where we have:

- outlined objectives and applications for each practice
- described use considerations, common failures, alternate measures, and relationship with other erosion and sediment control practices
- described design, materials, installation, inspection, maintenance, and removal

The measures are by no means all-inclusive. Variations are based on site-specific conditions, and there are other practices we didn't specifically discuss. The references cited at the end of this chapter give more detailed discussions of erosion control measures. Table 16.1 lists a matrix of uses for selected practices, and suggested symbology for plans.

The success of erosion and sediment control at

construction sites depends on the Contractor's design, construction, and maintenance of individual measures with regard to the site, to other measures, and to construction methods. Section 16.8 discusses revegetation, either temporary or permanent, which is integral to the process.

## **16.8. Revegetation**

Why revegetate an area? The reasons vary, and in this section we address some of the commonly accepted ones.

### **16.8.1 Vegetative Erosion Control**

Vegetative erosion control is based on the assumption that soil can be kept in place with a vegetative cover. The reasons to keep soil in place include:

- protection of engineered grades
- reduction of maintenance on buildings, structures, and other man-made objects
- maintenance of surface water quality
- visual enhancement

### **Temporary vs. Permanent Seedings**

Temporary seedings are intended, as the name implies, to provide immediate erosion protection until a permanent vegetation cover can be established. When seeding is used, annual ryegrass is the ideal material. However, the resulting vegetative mat formed may interfere with the establishment of permanent seedings if the site is not suitably prepared for the permanent seedings. An alternative to seeding could be loose mulch such as straw.

Use permanent seedings on final grades. The species used tend to be long-lived and suitable for erosion control. At times, a portion of the mix may be composed of annual ryegrass or some other annual species. In this case, the annual species provides quick temporary cover on the site and in some regard assists the permanent species in becoming established. When practical, permanent seedings should be chosen over temporary seedings.

### **Special Revegetation Techniques**

Special or alternative techniques for revegetation use materials other than seed to provide a vegetative cover. Usually, these techniques rely on vegetative (cuttings and sprigs) or transplanting procedures. These alternatives should be carefully assessed prior to implementation. Costs can be considerably higher than seeding. However, in certain circumstances, these

alternatives will provide the best results. This section will only cover seeding with grasses.

### **Streambank Revegetation**

This process is a specialized form of erosion control and revegetation. Often the technique is prescribed as a condition for protection of sensitive stream areas. When this technique is called for, refer to the publication Streambank Revegetation and Protection: A Guide For Alaska (1998) by G. A. Muhlberg and N. J. Moore. This guide is very well prepared and gives instruction on the proper method of installing the various treatments and orders of protection. See Chapter 17 of this manual for additional details.

### **Coastal Areas**

Coastal areas also present special problems in erosion control. These areas are often subject to high winds. The potential erosion problems associated with wind are often aggravated by sandy soils that are easily transported. The ideal species to use in these areas is Beach Wildrye. Again, a specific guide has been developed to address the use of this species: Beach Wildrye Planting Guide for Alaska (1994) by S. J. Wright.

### **Interior Alaska South Facing Slopes**

The south facing road cuts and fill slopes pose special problems in the Interior of Alaska. These sites tend to be very warm and dry. Much of the recent revegetation research has centered on selection of plant material suitable for these sites. Native wheatgrass species colonize these sites naturally. It is logical that if wheatgrass seed is applied during the revegetation process, it will establish on similar sites. Wainwright Slender Wheatgrass is a selection commercially available for use on this type of area. The species has been incorporated into seed mixes for the Interior.

An additional point to consider on south facing slopes is that seed/soil contact is critical in these situations. Drill seeding or incorporated broadcast seeding may give better seed/soil contact and moisture conservation than hydroseeding. It might be advisable to consider seed application methods used when dealing with dry south facing slopes.

### **Natural Revegetation**

With time, most disturbed sites will revegetate. However, very few landowners and managers find this revegetation approach acceptable. Surface preparation

techniques and fertilization can hasten the invasion of native plants, but the process can take many years.

### **Native Species**

Revegetation with native species is strongly encouraged. Federal agencies are directed or strongly encouraged to use native species by various Executive and Administrative Orders. These orders do not, as yet, specify germplasm source; however, species collected near a disturbance tend to be more biologically suited for revegetating the site.

The need to select more native species for revegetation in Alaska provided the incentive for the state to fund the seed collection program. This section will be updated when new native species become available. Also, in 2000, the Alaska Plant Materials Center published a revised Native Plant Directory.

Revegetation with native species provides the following advantages:

- They are better adapted and appear more natural than introduced species.
- Introduced species have the potential to escape into the natural environment. This problem has not yet become a grower's problem in Alaska. Some introduced species have, however, become well established; clovers are a good example, as is Reed Canarygrass in southeast, Interior, and southwest Alaska.

The use of introduced species for lawns and playing fields is acceptable.

Availability will, for the near term, be the primary obstacle in using native species. In-state production is increasing and market consistency is required to assure future availability. The Department of Transportation and Public Facilities (DOT&PF) is a critical component in the development of the native seed industry. While mandates to use native species may originate in other agencies, DOT&PF is often the primary agency faced with the issue of using native species. Much has been done in the past decade to make these materials available. Their performance is superior to introduced material, but prices may be higher. Most of the price issue is related to the simple laws of supply and demand. Eventually, prices will stabilize and then decline. Section 16.8.3 gives a list of potential commercially available native species. As these materials become available commercially or for demonstration projects, the Alaska Plant Materials Center, (907) 745-4469, will advise the end users,

including DOT&PF.

### **Species to Avoid**

In most areas of Alaska, avoid clovers because they have been known to invade native plant communities and attract large mammals (deer, moose, bear). This is especially true in remote areas.

### **Landscape and Wildflower Plantings**

Landscape plantings are included in this section simply as an advisory note. This form of revegetation includes all plantings around buildings and special emphasis areas where aesthetics are the primary concern. These plantings usually require a maintenance program and intensive management. They are not exactly erosion control projects but at times do contribute to a degree of erosion protection. The species used tend to be less hardy and often require supplemental waterings, fertilization and mowing for survival and the desired appearance. These mixes are important but not in the context of this section. Landscape plantings require very specific local knowledge based on specific site conditions and the designer's concept of the final product. They are not addressed in this section. Nugget Kentucky Bluegrass and Arctared Red Fescue are often used in grass mixes intended for this purpose. In some areas, the large expanses of highly palatable, manicured lawns attract geese and other unwanted pests. It is best to rely on local knowledge with regard to landscape plantings, including lawns, shrubs, and trees. It is not worth the trouble to recommend designs for these situations unless the designer is fully aware of all of the local problems and conditions. Wildflower research is progressing. In a few years, mixes or selections will be incorporated into the seed selection charts. For the time being, if you want wildflowers, limit selections to lupine, yarrow, and whatever is commercially available.

## **16.8.2 Basic Steps of Revegetation**

### **Operations**

As the first step in any revegetation project, determine the timing and sequence of operations. This planning is critical, since the designer is working with biological processes that have specific timing and environmental requirements.

In addition to identifying the type and purpose of revegetation, carefully consider logistics. After the project contract is awarded, the Contractor should purchase seed and plant materials to ensure that the

revegetation portion of the project can be completed while equipment and personnel are available.

Make contractors aware that cultivars could be difficult to obtain. If questions arise, the Contractor should contact local suppliers regarding availability or contact the State of Alaska, Department of Natural Resources, Plant Materials Center at (907) 745-4469.

### **Site Preparation**

Site preparation methods are fairly standard for all forms of revegetation. An adequately prepared site will have these characteristics:

- Free of construction debris.
- Relatively few large rocks or other natural objects.
- Free of ruts or gullies.
- Top two inches should be in a friable condition (non-compacted), ideally allowing a heel to make a 1/4-inch impression.
- Heavily compacted sites should be scarified to a depth of 6 to 8 inches.

### **Methods of Preparation**

Availability of soil preparation equipment is often limited, but the Contractor can often use standard construction machinery. For example, ripper teeth on a grader tool bar will adequately prepare a site. Ideally, scarification will be done in two passes perpendicular to each other. However, on sloping land and in areas of high wind, use mono-directional scarification perpendicular to the direction of slope or prevailing wind. Appendix A to this chapter illustrates a number of methods. If traditional surface preparation equipment such as disks and/or chisel plows are available, the conditions required for adequate surface preparation are the same as previously noted.

- Note: If hydroseeding is used to apply seed, surface preparation as described in this section may not be necessary.

### **Seed Specifications**

Quality seed is a critical component to success. The ideal method to assure quality is to specify "certified" seed. Certified seed must meet certain standards for germination and purity, and certification provides some assurance of genetic quality.

Some native seed species are not available as certified seed; however, you may ascertain seed quality by examining percent germination and percent purity, which is required information for any seed sold in

Alaska.

Determine the true cost of seed by multiplying percent germination by the percent purity, which equals Pure Live Seed (PLS). Then multiply PLS by the price per pound. These calculations can increase the accuracy of bid comparisons. All seed sold or used in the state of Alaska must also be free of noxious weeds, which is noted on seed tags along with germination and purity. The seed mixes presented in this section have been carefully developed and are based on results from trials throughout the state. Give careful consideration before deviating from the recommendations. If problems occur or questions arise regarding seed, call the Alaska Plant Materials Center. Seed stored on site should be kept cool, dry, and in rodent-free areas.

### **Certified Seed**

The term Certified Seed causes confusion, as it is used to describe two different issues.

The first and proper use of the term “C”ertified Seed (with a capital “C”) is seed that has been grown under the rules of the Seed Certification Program. This is a program that denotes pedigree of the named cultivar; i.e., ‘Arctared Red Fescue.’

The term cultivar is analogous to a model. For example, with pickup trucks, one might view Ford, Dodge or Chevy as “species.” Within these species, you can select cultivars, or “models,” such as F-250 or W-350. Each model (cultivar) has special or unique abilities over the other model.

Certified seed is much like the pedigree of a registered dog: it simply states that the seed is from a defined source. Also, Certified seed must have been produced under the rules of the Certification agency. Certified Seed is the usual commercial category of seed. Its ancestry can be traced back to Registered Class or Foundation Class and Breeder Seed. In addition, the Certified Seed must meet variable standards of purity and germination. These standards are marketing tools and means of verifying authenticity of a seed source. ‘Arctared’ Red Fescue, along with all Alaska varieties or cultivars, can be sold as Certified or common.

Seed can also be “c”ertified (lower case “c”) free of weeds and as having minimum germination. This has nothing to do with pedigree protection or variety identification. It simply gives the quality of the seed. In other words, the buyer knows quality but has no assurance of type (other than species).

If possible, you should use Certified (with a capital C)

seed, but it is sometimes unavailable. Seed produced in Alaska is easy to trace to origin. Therefore, if Alaska-produced seed is used, the chances are that seed is from its stated origin. It may be common (uncertified) Arctared, but it is still Arctared. Minimum purities and germination should be stated with orders. Common seed is a usable product and will be necessary to meet demands. Common seed should meet “C”ertified germination and purity standards. But these, too, may need to be relaxed if the job is to get done. Lower germination rates can be overcome by increasing seeding rates. You should carefully consider using lower purity seed, however, as weeds can be very problematic.

### **Other Certification Classes**

Many new native seed sources are being developed in Alaska. They, for the most part, will not be sold as “C”ertified Seed. They may carry the designations: Source Identified, Tested, or Selected. These classes will usually be in keeping with the “C”ertification system, but the term “C”ertified Seed will not apply. On the other hand, certification of germination and purity will still apply.

#### **16.8.3 Cultivars & Species for Use in Alaska**

The following listing of adapted, commercially available species and cultivars represents what is available in Alaska. None pose a sight distance problem. All will be less than 24 inches high. Appendix B presents tables for the selection of species and cultivars by region within Alaska.

- a. ‘Arctared’ Red Fescue, *Festuca rubra*, was released in 1965 as a revegetation species showing extreme hardiness throughout Alaska (Hodgson, 1978). The overly aggressive, sod-forming nature of this species often makes this cultivar unacceptable in reclamation. However, in erosion control the cultivar is outstanding. Also, the aggressive nature of this sod forming species may be a way of preventing the invasion of native shrub species such as alder and willow. The University of Alaska Agricultural Experiment Station and the USDA cooperatively developed the cultivar.
- b. ‘Boreal’ Red Fescue, *Festuca rubra*, was developed by the Canadian Department of Agriculture Research Station, Beaverlodge, Alberta (USDA 1972). This very hardy cultivar is similar to Arctared in adaptation and potential use in Alaska. It is often substituted

for Arctared and is less expensive.

- c. 'Pennlawn' Red Fescue, *Festuca rubra*, was released in 1954 by the Pennsylvania Agricultural Experiment Station (USDA 1972). The cultivar is not as hardy as Arctared or Boreal, but still has potential in milder areas of Alaska. This cultivar was selected for turf uses, and therefore, tends to be used for landscaping more than for revegetation.
- d. 'Egan' American Sloughgrass, *Beckmannia syzigachne*, was released by the Alaska Plant Materials Center in 1990 as a wetland rehabilitation cultivar (Wright, 1991a). This is the state's first cultivar developed solely for wetland restoration. Additionally, the species has wildlife benefits by providing forage and seed for waterfowl (Wright 1992).
- e. 'Alyeska' Polargrass, *Arctagrostis latifolia*, is a cultivar developed by the University of Alaska Agricultural Experiment Station. The prime purpose for this cultivar is revegetation in interior and western Alaska (Mitchell, 1979). The species is adapted to moderately wet areas (Wright 1992).
- f. 'Kenai' Polargrass, *Arctagrostis latifolia*, is a variety recommended for forage and revegetation in the central interior and southern portions of Alaska (Mitchell, 1987). This species has potential for revegetating wet areas. This cultivar was developed by the Alaska Agriculture and Forestry Experiment Station at Palmer, Alaska.
- g. 'Sourdough' Bluejoint, *Calamagrostis canadensis*, is a cultivar with a wide range of adaptability. The species occurs throughout Alaska on both dry and wet sites. The cultivar was developed by the University of Alaska Agricultural Experiment Station for revegetation in northern latitudes (Mitchell, 1979). Commercial availability is erratic, and when it is available, the seed is expensive (Wright 1992).
- h. 'Norcoast' Bering Hairgrass, *Deschampsia beringensis*, was released in 1981 by the University of Alaska Agricultural Experiment Station as a forage and revegetation grass in northern areas. Norcoast is recommended for revegetation use in coastal regions of western Alaska to southwestern Alaska and possibly in the northern maritime regions (Mitchell, 1985).
- i. 'Nortran' Tufted Hairgrass was also released by the University of Alaska Agricultural Experiment Station. Intended use is similar to Norcoast; however, this cultivar is better adapted to northern regions of Alaska (Mitchell, 1985).
- j. 'Tundra' Glaucous Bluegrass, *Poa glauca*, was originally collected in Arctic Alaska. The cultivar was released by the University of Alaska Agricultural Experiment Station for revegetation in extreme northern areas with severe environmental conditions (Mitchell, 1979).
- k. 'Caiggluk' Tilesy Sagebrush, *Artemisia tilesii*, was developed and released by the Alaska Plant Materials Center in 1989 as a reclamation species. This forb has a wide range of adaptations throughout Alaska (Wright, 1992).
- l. 'Gruening' Alpine Bluegrass, *Poa alpina*, was released by the Alaska Plant Materials Center in 1986. The species is widely adapted throughout Alaska. As the name implies, the species is adapted to high elevation areas. It also performs well on sites drier than those tolerated by Kentucky bluegrass. Seed availability is limited. Before this cultivar is included in a planting plan, you should research the availability of the seed.
- m. 'Nugget' Kentucky Bluegrass, *Poa pratensis*, was released and developed by the University of Alaska Experiment Station in 1966. The source of this cultivar was a single plant collection made in 1957 at Hope, Alaska. Nugget has outstanding winter survival (USDA 1972), and is used extensively in Alaska for turf and lawns.
- n. 'Park' Kentucky Bluegrass, *Poa pratensis*, was developed by the Minnesota Agricultural Experiment Station in 1957 (USDA 1972). Hardiness of this cultivar is not as good as Nugget in extreme northern areas of Alaska. However, it is still used in volume in Alaska. Like Nugget, its use tends to be limited to landscape and lawns.

- o. 'Merion' Kentucky Bluegrass, *Poa pratensis*, was released in 1947 by the USDA Plant Service Research Division, ARS and the U.S. Golf Association Green Section. The cultivar is more adapted to close mowing than any other Kentucky bluegrass (USDA 1972). Merion is often used in lawn mixes in Alaska.
- p. 'Reeve' Beach Wildrye, *Elymus arenarius* (*Leymus arenarius*), is a 1991 release of the Alaska Plant Materials Center. The cultivar has high potential in coastal restoration, especially in the fore dune and other sandy sites throughout coastal Alaska (Wright 1991a).
- q. 'Benson' Beach Wildrye, *Elymus mollis* (*Leymus mollis*), is a cultivar of native species released by the Alaska Plant Materials Center in 1991 (Wright 1991b). Unlike Reeve, Benson is available only from vegetative cuttings (sprigs). Seed will not be available. Benson was selected for use in sandy areas of high erosion potential. Revegetation with sprigs is a preferred method of revegetating at highly erosive areas.
- r. Annual & Perennial Ryegrass. There are no cultivars called for in these species since long-term survival is not critical and may not be desirable. These species provide a quick, temporary cover and should be limited to 10% or less of a seed mix. These species use nutrients that are intended for the perennial species included in the mixes and can produce a heavy plant cover, which can slow the growth of the perennial species. Annual and perennial rye grass are also very attractive to herbivores, which may cause vehicle/animal conflicts.

#### **16.8.4 Fertilizer & Other Soil Amendments**

##### **Fertilizer**

In all forms of revegetation, applications of fertilizer at the time of seeding are necessary. Most commercial fertilizers meet minimum standards, and quality problems are seldom encountered. If problems arise with fertilizers, they can usually be traced to the product becoming wet during storage or shipment.

If possible, you should apply fertilizer at the same time or prior to seeding, because once the seed has been applied, you should allow no additional traffic on the site.

Generally, we recommend a 20-20-10 fertilizer unless specific site conditions require different proportions. The numbers are percentages of three elements: nitrogen, phosphorus, and potassium, respectively. Therefore, 20-20-10 fertilizer contains 20% nitrogen, 20% phosphorus, and 10% potassium by weight.

##### **Lime & Other Amendments to Adjust pH**

Using adapted or native species will not require the use of lime or agents to acidify the soils. In testing throughout the state, amendments have never been needed to establish effective stands of vegetation, provided adapted or native species are used. The species and varieties called for in this manual will survive and produce effective stands without amendments.

Lawns, playing fields, and other high maintenance areas may require lime if extremely lush growth is required. These areas will only benefit from such application if pH is lower than 5.0.

##### **Topsoil**

Gravelly sites tend not to be highly erodible, and if some fines are present, can grow adapted species without topsoil. The addition of a layer of topsoil on the gravel surface could increase the erosion potential. The top layer of soil in undisturbed areas often is very thin and expensive to salvage. However, this layer is a source of native seed, plant propagules, organic matter, and soil microbes, which can enhance the quality of the substrate being revegetated. This, however, on its own does not warrant the use of topsoil. Often, imported topsoil is a very peaty material, and although it may look dark and rich, it does not provide a suitable growing medium. Restrict topsoil use to high maintenance lawn areas and other non-erosion control landscape and visual enhancement projects.

#### **16.8.5 Equipment Needs (Specialized)**

Normally, the Contractor supplies the equipment for a revegetation project. This section on equipment will give the designer the advantages and drawbacks of each.

##### **Broadcast Seeders**

Broadcast seeders are usually the least expensive and require less training and support equipment. Broadcast type equipment can usually be used for both seed and fertilizer.

##### **Drop Spreaders**

Drop application methods rely on gravity feed, are simple in design, and are easy to use. Two problems can occur with this method: stripes can appear if the drop



pattern is not overlapped; and the equipment will corrode if it is not thoroughly cleaned after applying fertilizer. Avoid stripes in lawn areas by setting the spreader at 1/2 the recommended application rate and running two tracks perpendicular to each other over the site. Drop spreaders tend to be more precise than broadcast seeders.

### **Drill Seeders**

Drill seeders most often are used in agricultural settings. Only one drill seeder, the Brillion, has been used for revegetation of mine and construction sites. This seeder has been used on most soil types except very gravelly soils. Fertilizer cannot be applied with this seeder; however, the unit incorporates the seed into the soil, packs the seed in place, and provides accurate application rates. This allows the seeding rate to be reduced by 50 percent.

### **Hydroseeding**

In recent years, hydroseeding has been portrayed as the most effective means for revegetating an area. However, many professionals are finding that this claim is overstated. Hydroseeders are well suited for seeding steep slopes and rocky areas; and they apply mulch, seed, and fertilizer in one step. The primary disadvantage is the requirement for large quantities of water, which at times can result in numerous trips across the land that is being revegetated. The equipment is complex, and mechanical problems can result in delays. Hydroseeder manufacturers have claimed that hydroseeding promotes more vigorous plant growth; however, that claim has not proven to be true. Grass growth can be inhibited if too much mulch is applied.

Hydroseeders come in truck-mounted and trailer form. Major Contractors either have a hydroseeder or can easily subcontract for one. Hydroseeders are often used as supplemental watering trucks once seed has been applied. Additional watering is not always necessary to produce a good stand of vegetation; and it does cost more. Without additional watering, the seed will wait until there is sufficient moisture to germinate.

A hydroseeding contract should state that seed will not remain in the hydroseeder for more than one hour. This practice will prevent seed from absorbing excessive water and being damaged.

### **16.8.6 Mulch & Erosion Matting**

Mulches and erosion matting are only appropriate or necessary if erosion potential is significant. Erosive forces can be either wind or water. However, when hydroseeders are used, mulch is standard. The mulch fiber forms a slurry that acts as a carrier for the seed and fertilizer. Without the mulch, seed and fertilizer would not suspend in solution, and uniform distribution would be impossible. The mulch also marks the area that has been sprayed.

When deciding on the use of a mulch such as straw or an erosion matting, consider several factors, erosion potential being the first. If the soil does not have a high erosion potential, then mulch and/or matting should be skipped. Secondly, consider the cost. Application of mulch and matting adds significant costs to a project, not only in materials, but also in labor. Next, consider safety. The concern with some netting is the potential of sections coming loose and causing a hazard. Finally, remember that straw may introduce unwanted noxious weeds.

The above concerns do not apply to wood and paper fiber or similar products used in hydroseeders.

**Table 16-1  
Erosion and Sediment Control Measures and Suggested Drawing Symbols**

Erosion & Sediment Control Measures	Structural Measures		Stabilization (Erosion Control)	Temporary/Permanent	Symbol
	Velocity Control	Sediment Control			
Interception/ Diversion Ditch	X			T, P	
Slope Drain	X			T	
Rock Flume	X			T, P	
Outlet Protection	X			T, P	
Storm water Conveyance Channel	X			T, P	
Rock Check Dam	X			T, P	
Mulching			X	T	
Temporary Seeding			X	T	
Surface Roughening and Terracing			X	T	
Rolled Erosion Control Products			X	T, P	
Temporary Sediment Trap		X		T	
Vegetative Buffer Strip		X		T, P	
Silt Fence		X		T	
Inlet Protection		X		T	
Straw Bale Barrier		X		T	
Brush Barrier		X		T	
Vehicle Tracking Entrance/Exit		X		T	

**Table 16-2  
Species/Cultivar Characteristic Chart**

Species	Cultivar	Percent Germination	Purity	Availability <sup>1</sup>	Site Conditions Adaptation	Growth Form <sup>2</sup>	Height Ave <sup>2</sup>
Red Fescue	Arctared	80	98	Very Good	Dry to Wet	Sod	18 in.
	Boreal	80	98	Excellent	Dry to Wet	Sod	18 in.
	Pennlawn	80	98	Excellent	Dry to Wet	Sod	12 in.
American Sloughgrass	Egan	75	90	Good	Wet	Bunch	18 in.
Bering Hairgrass	Norcoast	75	95	Excellent	Dry to Wet	Bunch	20 in.
Tufted Hairgrass	Nortran	75	95	1993 Poor	Dry to Wet	Bunch	20 in.
Polargrass	Alyeska	75	95	Fair	Wetter Areas	Sod	24 in.
	Kenai	75	95	Fair	Wetter Areas	Sod	24 in.
Bluejoint	Sourdough	75	95	Poor	All	Sod	36 in.
Tilesy Sagebrush	Caiggluk	75	95	Poor	All	Bunch	20 in.
Glaucous Bluegrass	Tundra	80	95	Fair	North of Alaska Range, Dry	Bunch	9 in.
Alpine Bluegrass	Gruening	80	90	Fair	Dry	Bunch	6 in.
Kentucky Bluegrass	Nugget	80	95	Excellent	Lawns	Sod	9 in.
	Park	80	95	Excellent	Lawns	Sod	9 in.
	Merion	80	95	Excellent	Lawns	Sod	9 in.
Beach Wildrye	Benson	-	-	Poor	Sandy, Dry	Sod	24 in.
	Reeve	30	95	Poor	Sandy, Dry	Sod	24 in.
Annual Ryegrass	-	80	95	Excellent	Dry, Limit Use	Temp	
Perennial Ryegrass	-	80	95	Excellent	Dry, Limit Use	Temp	

<sup>1.</sup> Availability varies from year to year and within a given year.

<sup>2.</sup> Growth form and height will vary with conditions. Typical DOT&PF sites will tend to produce shorter and bunchier stands of these species.

**Table 16-3  
Characteristics of Various Spreading Equipment\***

Type	Advantages	Disadvantages
Hand-held Spinner Type Spreader	<ul style="list-style-type: none"> <li>Inexpensive</li> <li>Simple to use &amp; repair</li> <li>Can apply both fertilizer &amp; seed</li> <li>No special training needed</li> </ul>	<ul style="list-style-type: none"> <li>Slow</li> <li>High labor use</li> <li>Skip &amp; overlap possible</li> <li>Seed may need to be incorporated into the soil following application</li> </ul>
Mechanical Spinner Type Spreaders	<ul style="list-style-type: none"> <li>Fast</li> <li>Can apply both seed &amp; fertilizer</li> <li>Relatively low-cost equipment</li> </ul>	<ul style="list-style-type: none"> <li>Skip &amp; overlap possible</li> <li>Seed may need to be incorporated into the soil following application</li> </ul>
Drop Type Spreaders	<ul style="list-style-type: none"> <li>Fast</li> <li>Simple</li> <li>Can be used to apply both fertilizer &amp; seed</li> </ul>	<ul style="list-style-type: none"> <li>Skip &amp; overlap a serious problem if care is not taken</li> <li>Hard to calibrate</li> <li>Equipment needs high degree of care</li> </ul>
Drill Type Seeders**	<ul style="list-style-type: none"> <li>Seed incorporation not needed as a separate step</li> <li>Precise application</li> <li>Skip not a problem</li> <li>Uses only half the seed</li> </ul>	<ul style="list-style-type: none"> <li>Does not apply fertilizer</li> <li>Equipment more costly</li> <li>Needs higher degree of seedbed preparations</li> </ul>
Hydroseeders	<ul style="list-style-type: none"> <li>Degree of slope not a problem</li> <li>Skip not a problem</li> <li>Can apply both seed &amp; fertilizer</li> </ul>	<ul style="list-style-type: none"> <li>Equipment costly and complex</li> <li>Needs water source</li> </ul>

\* The Contractor should choose the type of machinery for applying seed and fertilizer. The choice is often based on local availability. The Contractor should note the method in the bid response so the contracting officer can make an accurate comparison.

\*\* If drill seeders are employed, only use 1/2 the recommended seeding rates.

**Table 16-4  
Mulch & Netting Comparison Chart**

Mulch/Netting	Difficulty In Use	Erosion Resistance	Cost to Purchase	Cost to Apply	Environment Restrictions in Use	Most Effective on Soil Type
Wood/Paper Fiber	No	Low	Low	Low	Few	All
Straw	No	Medium	High	Moderate	High Winds Hamper Use	Fine Grain
Jute Mesh	Yes	Medium	Moderate	High	None	Course Grain
Tack Netting	Yes	Low	Moderate	High	None	Course Grain
Excelcior	Yes	High	High	High	Plastic Netting Could be a Problem	All
Chemical Stabilizer	No	Varies	Varies	Low	Temperature Requirement	Course Grain

## 16.9. References

- AASHTO. 1999. *Guideline Volume III, Erosion and Sediment Control in Highway Construction*.
- Division of Soil and Water Conservation, Virginia Department of Conservation and Historic Resources. 1980. *Virginia Erosion & Sediment Control Handbook, Second Edition*. 230 Governor Street, Suite 206, Richmond, Virginia.
- Hodgson, H. J., R. L. Taylor, L. J. Klebesadel, A. C. Wilton. 1978. "Registration of Arctared Red Fescue." *Crop Science*, Vol. 18:524.
- Mitchell, W. W. 1979. *Three Varieties of Native Alaskan Grasses for Revegetation*. Circular 32. AES. SALRM University of Alaska. Fairbanks.
- Mitchell, W. W. 1985. "Registration of Norcoast Bering Hairgrass." *Crop Science*, Vol. 25:708-709.
- Mitchell, W. W. 1986. "Notice of Release of Nortran Tufted Hairgrass." *Agroborealis*, Vol. 18, No. 1.
- Mitchell, W. W. 1987. "Notice of Release of Kenai Polargrass." *Agroborealis*, Vol. 19, No 5.
- North Carolina Sedimentation Control Commission. 1988. *Erosion and Sediment Control Planning and Design Manual*. North Carolina Department of Natural Resources and Community Development.
- Sherwood W. Cullen and David C. Wyant. 1976. "Installation of Straw and Fabric Filter Barriers for Sediment Control." Virginia Highway and Transportation Research Council, Report No. VHTRC 77-R18.
- U.S. Department of Agriculture. 1972. "Grass Varieties in the United States." *Agriculture Handbook*, No. 170. ARS, USDA. Washington, D.C.
- U. S. Department of Interior, Bureau of Reclamation. 1958. "Hydraulic Design of Stilling Basins and Energy Dissipators," Engineering Monograph No. 25.
- U. S. Department of Transportation, Federal Highway Administration. 1975. "Design of Stable Channels with Flexible Linings," Hydraulic Engineering Circular No. 15.
- U. S. Department of Transportation, Federal Highway Administration. 2000. "Hydraulic Design of Energy Dissipators for Culverts and Channels," Hydraulic Engineering Circular No. 14SI.
- USEPA. September, 1992. "Storm Water Management for Construction Activities, Developing Pollution Prevention Plans and Best Management Practices." EPA 832-R-92-005. Office of Water WH-547. From: USEPA, Office of Wastewater Enforcement and Compliance, 401 M Street, SW, Mail Code EN-336, Washington, D.C. 20460.
- USEPA. October, 1992. "Summary Guidance."
- USEPA. 1992. "Storm Water Management for Construction Activities, Developing Pollution Prevention Plans and Best Management Practices." EPA 832-R-92-005.
- USEPA. 1992. "Storm Water Management for Construction Activities, Summary Guidance." EPA 833-R-92-00.
- Wright, S. J. 1984. "Advances in Plant Materials and Revegetation Technology in Alaska." *Proceedings of the High Altitude Revegetation Conference*. Colorado State University. Fort Collins, CO.
- Wright, S. J. 1991a. "Registration of Egan American Sloughgrass." *Crop Science*, Vol. 31, No. 5 31:1380-1381.
- Wright, S. J. 1991b. "Registration of Caiggluk Tilesy Sagebrush." *Crop Science*, Vol. 31, No. 5 31:1380.
- Wright, S. J. 1991c. "Registration of Gruening Alpine Bluegrass." *Crop Science*, Vol. 31, No. 5 31:1379-1380.
- Wright, S. J. 1991d. "Release Notice – 'Reeve' Beach Wildrye." State of Alaska, Division of Agriculture, Plant Materials Center. Palmer.
- Wright, S. J. 1991d. "Release Notice – 'Benson' Beach Wildrye." State of Alaska, Division of Agriculture, Plant Materials Center. Palmer.

# **APPENDIX A**

## **Erosion CONTROL Practices (BMPs)**

## Appendix A Contents

<b>Erosion Control Measure</b>	<b>Page</b>
<b>Interception/Diversion Ditch</b>	<b>16-A-3</b>
<b>Slope Drain</b>	<b>16-A-6</b>
<b>Rock Flume</b>	<b>16-A-9</b>
<b>Outlet Protection</b>	<b>16-A-11</b>
<b>Stormwater Conveyance Channel</b>	<b>16-A-14</b>
<b>Rock Check Dam</b>	<b>16-A-18</b>
<b>Mulching</b>	<b>16-A-21</b>
<b>Temporary Seeding</b>	<b>16-A-23</b>
<b>Surface Roughening and Terracing</b>	<b>16-A-25</b>
<b>Rolled Erosion Control Products</b>	<b>16-A-30</b>
<b>Temporary Sediment Trap</b>	<b>16-A-34</b>
<b>Vegetative Buffer Strip</b>	<b>16-A-37</b>
<b>Silt Fence</b>	<b>16-A-40</b>
<b>Inlet Protection</b>	<b>16-A-44</b>
<b>Straw Bale Barrier</b>	<b>16-A-50</b>
<b>Brush Barrier</b>	<b>16-A-53</b>
<b>Vehicle Tracking Entrance/Exit</b>	<b>16-A-55</b>

## **Interception/Diversion Ditch**

### **Objectives and Applications**

An interception/diversion ditch, berm or excavated channel or combination berm and channel constructed across a slope that functions to intercept runoff and divert it to a stabilized area where it can be safely discharged.

This measure should be used in construction areas where runoff can be diverted and disposed of properly to control erosion, sedimentation, or flood damage. Specific locations and conditions include above disturbed existing slopes, and above cut or fill slopes to prevent runoff over the slope; across unprotected slopes, as slope breaks, to reduce slope length; below slopes to divert excess runoff to stabilized outlets; where needed to divert sediment laden water to sediment traps; at or near the perimeter of the construction area to prevent sediment from leaving the site; above disturbed areas before stabilization to prevent erosion and maintain acceptable working conditions; around buildings or areas that are subject to damage from runoff, and during culvert installations where water must be temporarily diverted around the construction area. Diversions may be either temporary or permanent.

### **Common Failures** - *Generally due to faulty installation or maintenance.*

- Berm not properly compacted during construction, resulting in uneven settling.
- Sediment accumulation against berm/channel not removed periodically, resulting in berm not functioning properly.

### **Other Considerations**

- Berms to intercept and divert runoff should not be used where the drainage area exceeds 10 acres.
- Interception/diversion ditches should be carefully designed where longitudinal ditch slopes are steeper than 10 per cent.

Diversions are preferable to other types of man-made storm water conveyance systems because they more closely simulate natural flow patterns and characteristics, and flow velocities are generally kept to a minimum.

### **Relationship to Other ESC Measures**

Diverted runoff should outlet to a stabilized area such as a sediment basin, detention or retention basin, or stabilized outlet, which should be established prior to introducing runoff from the diversion.

### **Alternate Sediment Control Measures**

Slope Drain (can be used in association with this measure).

### **Other Names**

Interceptor Ditch, Crown Ditch

### **Design**

**Location:** *Should be determined by considering outlet conditions, topography, land use, soil type, and length of slope.*

**Capacity:** *permanent: 10 year peak runoff storm.  
temporary: 2 year peak runoff storm.*

### **Berm**

**Berm Top Width:** *minimum 2 ft)*

**Berm Base Width:** *minimum 4.5 ft.*

**Berm Height:** *minimum 18 in.)*

**Berm Side Slopes:** *2:1 or flatter*

### **Ditch**

**Channel Freeboard:** *minimum 6 in.*

**Channel Side Slopes:** *2:1 or flatter*

### **Materials**

Compacted soil or coarse aggregate, riprap, filter fabric, plastic lining, seed and mulch, sandbags

### **Installation**

#### **Interception Ditch**

*Remove and properly* dispose of all trees, brush, stumps, or other objectionable material. Fill and compact all ditches, swales, or gullies that that will be crossed to natural ground level. Excavate, shape, and stabilize the diversion to line, grade, and cross section as required in the plans. Compact the berm to prevent unequal settlement and to provide stability against seepage. Stabilize the diversion with vegetation after installation.



### Diversions for Culvert Installations

Excavate the diversion channel to the specified dimensions, leaving temporary plugs at both ends. Place channel lining and stabilize with riprap or sandbags. Remove plugs at both ends (down-stream first) and divert water into the diversion with sandbags. After installation of the culvert is complete, replug the diversion, salvage the diversion lining, and backfill in the channel.

### **Inspection**

Inspect the diversion every week and after each rainfall during construction operations, as directed by the specifications.

### **Maintenance**

Remove any sediment or other obstructions from the diversion channel. Check outlets and make repairs as necessary. Reseed areas that fail to establish a vegetative cover.

### **Removal**

Temporary installations – Restore to existing or constructed grade. Seed and mulch.

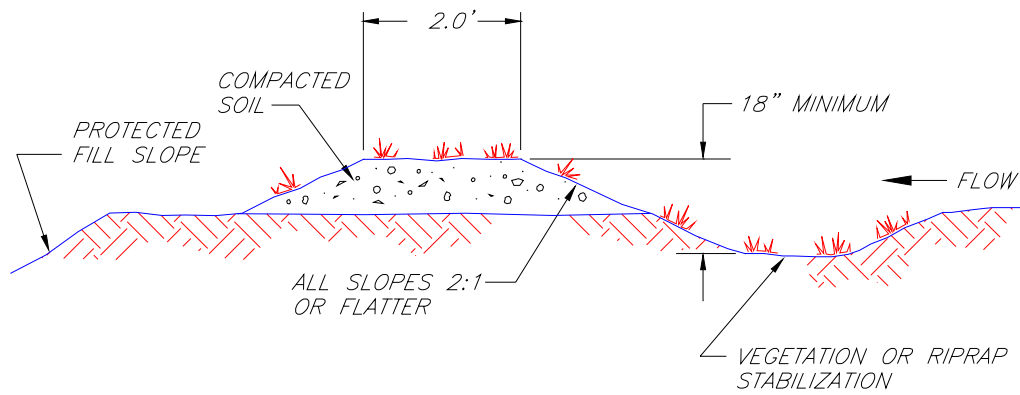

**TYPICAL FILL DIVERSION**

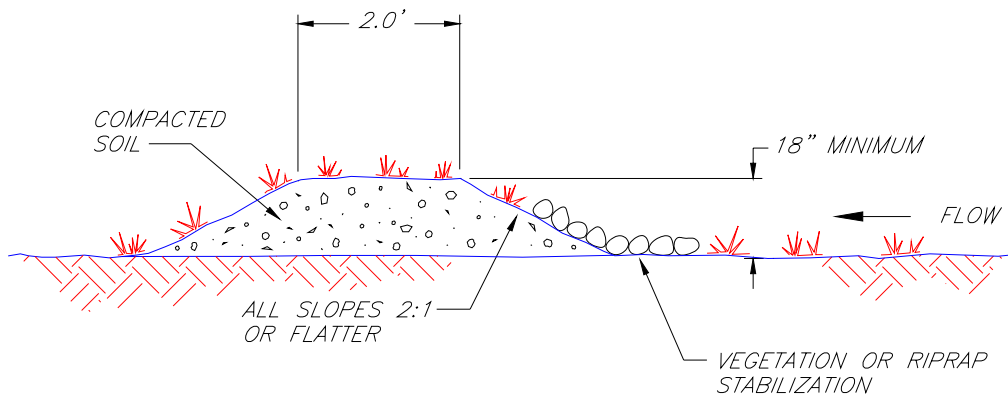

**TYPICAL TEMPORARY DIVERSION DIKE**

1996 JOHN McCULLAH

**NOTES:**

1. THE CHANNEL BEHIND THE DIKE SHALL HAVE POSITIVE GRADE TO A STABILIZED OUTLET.
2. THE DIKE SHALL BE ADEQUATELY COMPACTED TO PREVENT FAILURE.
3. THE DIKE SHALL BE STABILIZED WITH TEMPORARY OR PERMANENT SEEDING OR RIPRAP.



FILE: TEMPDIKE

**INTERCEPTION/DIVERSION DITCH**

## Slope Drain

### Objectives and Applications

A slope drain is a flexible tubing or conduit extending temporarily from the top to the bottom of a cut or fill slope.

The purpose of a slope drain is to temporarily conduct concentrated storm water runoff safely down the face of a cut or fill slope without causing erosion on or below the slope. These are temporary measures that are used during grading operations, until the permanent drainage structures are installed, and until the slopes are permanently stabilized. The pipe material is typically corrugated plastic or flexible tubing, and is used in conjunction with temporary diversion dikes along the top edge of newly constructed slopes, that function to direct storm water runoff into the slope drain.

**Common Failures** - Generally due to faulty installation or maintenance.

- Slope drain sections not securely fastened together; fittings not water tight, resulting in leakage.
- Slope drain sections not securely anchored to the slope, resulting in displacement of the structure.
- Materials placed on, or construction traffic across slope drain, resulting in damage to the structure.

### Other Considerations

- Provide both inlet and outlet protection to minimize erosion at these locations.
- Slope drains should be used in conjunction with diversion dikes to convey runoff from the drainage area.
- The entrance section must be securely entrenched, all connections must be watertight, and the conduit must be securely staked.

### Relationship to Other ESC Measures

Slope drains are used with temporary diversion dikes to facilitate channeling of runoff into the structure. Inlet and outlet protection are required to minimize erosion and scour.

### Alternate Sediment Control Measures

Diversion

### Other Names

Downdrain; Drop Pipe

### Design

**Design life:** 1 season (6 months) or less

**Contributing flow drainage area:** should not exceed 5 acres per slope drain. If contributing drainage area exceeds this amount, consider using a more permanent installation such as a rock-lined flume, etc.

**Capacity:** 2 year peak runoff or the design discharge of the water conveyance structure, whichever is greater

Slope drain size (minimum)	
Drainage area (Acres)	Pipe diameter (Inches)
0.5 ac.	12 in.
1.5 ac.	18 in.
3.5 ac.	24 in.
5.0 ac.	30 in.

**Flexible conduit:** heavy duty flexible material, such as corrugated plastic pipe or plastic tubing

**Inlet section:** standard flared end section for metal pipe culverts, or geotextile, for inlet protection

**Diversion dike height:** minimum 12 in. higher than the top of the drain pipe

**Island over inlet height:** minimum 18 in. higher than the top of the drain pipe

**Outlet section:** riprap or geotextile, for outlet protection

### Materials

Flexible corrugated plastic pipe or specially designed plastic tubing; grommets or stakes (for fastening); riprap, geotextile

### Installation

Place slope drains on undisturbed ground or well-compacted fill at locations specified on the plans. Place the entrance of the drain in a 6 in. sump at the top of the slope. Hand tamp the soil under and around the entrance in 6 in. lifts. Ensure that fill over the top of the drain has minimum dimensions of 18 in. height,

4 ft. top width, and 3:1 side slopes. Install inlet protection using end section for pipes or geotextile. Use watertight fittings at all slope drain connections. Securely fasten the exposed section of the pipe with grommets or stakes at 10 ft. spacings. Extend the drain beyond the toe of the slope and provide riprap or geotextile outlet protection. Construct the diversion dike 12 in. above the top of the pipe entrance. Compact and stabilize the dike.

### **Inspection**

Inspect slope drains weekly and immediately after each rainfall that produces runoff for erosion around the inlet and outlet that could result in undercutting or bypassing. Inspect the pipe for breaks or clogs.

### **Maintenance**

Immediately repair any erosion around the inlet or outlet; install a headwall, riprap, or sandbags if necessary. Promptly repair any breaks in the pipe and clear any clogs that reduce flow through the structure.

### **Removal**

After the slope has been permanently stabilized and the permanent drainage system has been installed, remove the slope drains and stabilize the remaining disturbed areas.

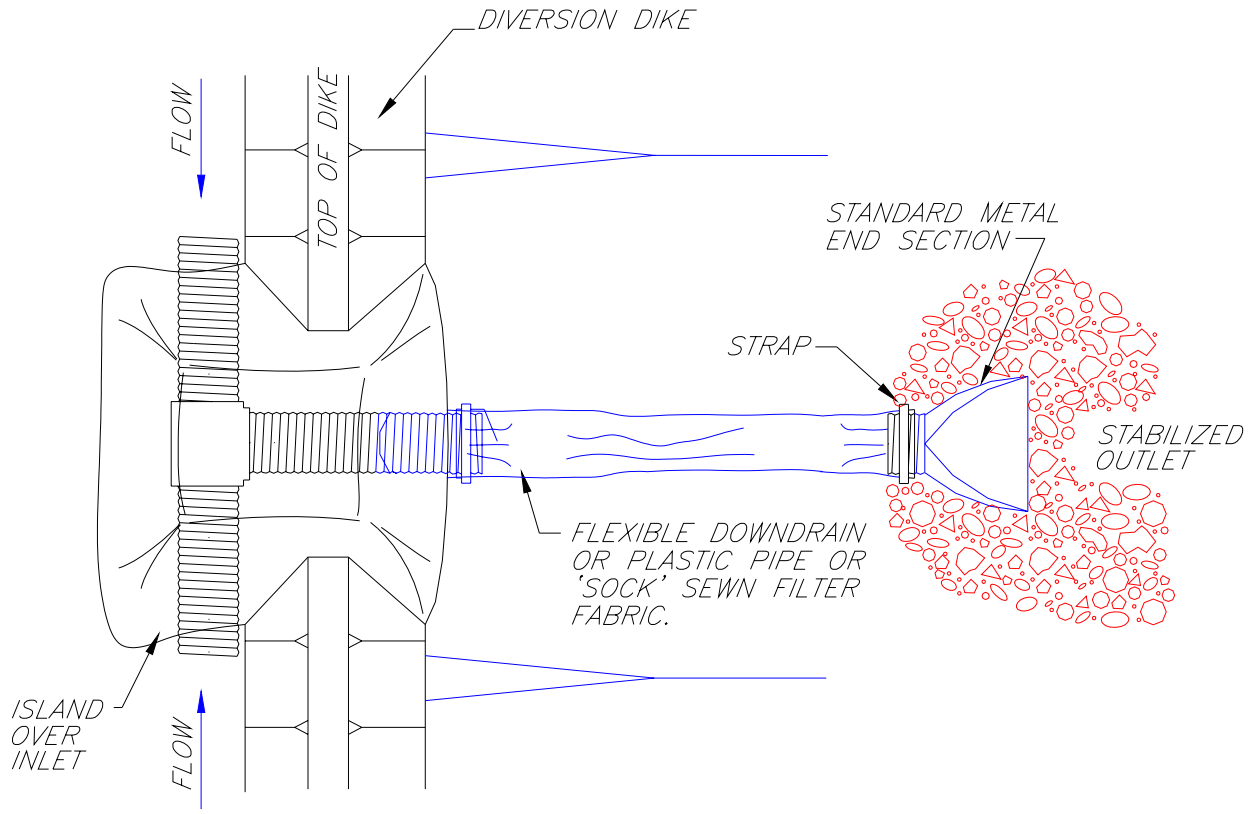

PLAN VIEW

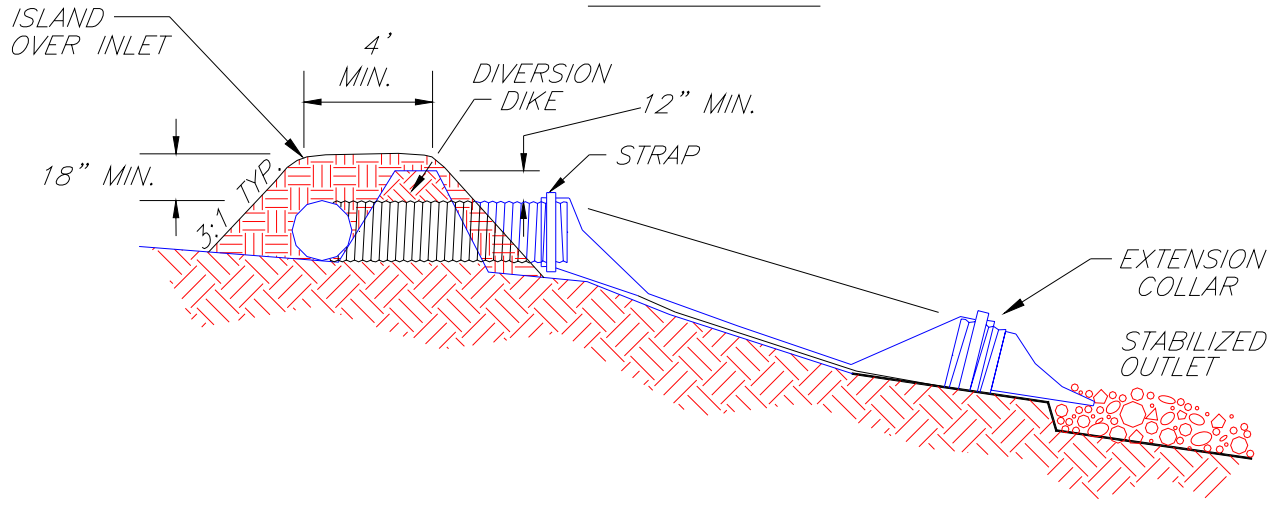

SECTION

**SLOPE DRAIN**

## Rock Flume

### Objectives and Applications

A rock flume is a riprap-lined channel to convey water down a relatively steep slope without causing erosion problems on or below the slope.

Flumes serve as stable, permanent elements of a storm water system receiving drainage from above a relatively steep slope, typically conveyed by diversions, channels, or natural drainageways.

Drainage will flow down the rock culvert and into a stabilized outlet, sediment trap, or other conveyance measure.

**Common Failures** - Generally due to faulty installation or maintenance.

- Stone size too small or backslope too steep, resulting in stone displacement.
- Sediment accumulation in flume channel, resulting in reduced capacity.
- Channel width too narrow, resulting in over topping and erosion.

### Other Considerations

- Provide both inlet and outlet protection to minimize erosion at these locations.
- Rock flumes should be used in conjunction with diversion dikes to convey runoff from the drainage area.
- When planning rock flumes, consider flow entrance conditions, soil stability, outlet energy dissipation, and downstream stability.

### Relationship to Other ESC Measures

Rock flumes assist in the second, conveyance, stage of a BMP system. Rock flumes are used with diversion dikes to facilitate channeling of runoff into the structure

### Alternate Sediment Control Measures

Storm water conveyance channel

### Other Names

Rock chute, rock downdrain

### Design

**Contributing flow drainage area:** not to exceed 10 acres per rock flume.

**Capacity:** 10 year peak runoff or the design discharge of the water conveyance structure, whichever is greater.

Flume Channel Lining	
Drainage Area (Acres)	Riprap Sizes (Class)
5.0 ac	Class I
10.0 ac	Class II

**Slope:** not to exceed 1.5:1 (67 %)

**Depth:** minimum 1 ft.

**Alignment:** straight

**Inlet section:** riprap and geotextile, or flared metal end section for inlet protection

**Outlet section:** riprap and geotextile, for outlet protection

### Materials

Riprap, geotextile, flared metal end section

### Installation

Remove all unsuitable material, such as trees, brush, roots, or other obstructions prior to installation. Shape the channel to proper grade and cross-section as shown in the plans, with no abrupt deviations from design grade or horizontal alignment. Compact all fills to prevent unequal settlement. Place geotextile prior to placement of riprap.

### Inspection

Inspect flume channels at regular intervals as well as after major rains for sediment accumulation, material displacement, bank failures, and scour at inlet and outlet sections.

### Maintenance

Rock flume channels should be checked periodically to ensure that scouring is not occurring beneath the fabric underlying the riprap layer, or that the stones have not been displaced by the flow. Sediment should be removed from the riprap lined channel if it reduces the capacity of the channel.

### Removal

Rock flumes will normally be left in place after construction is completed.

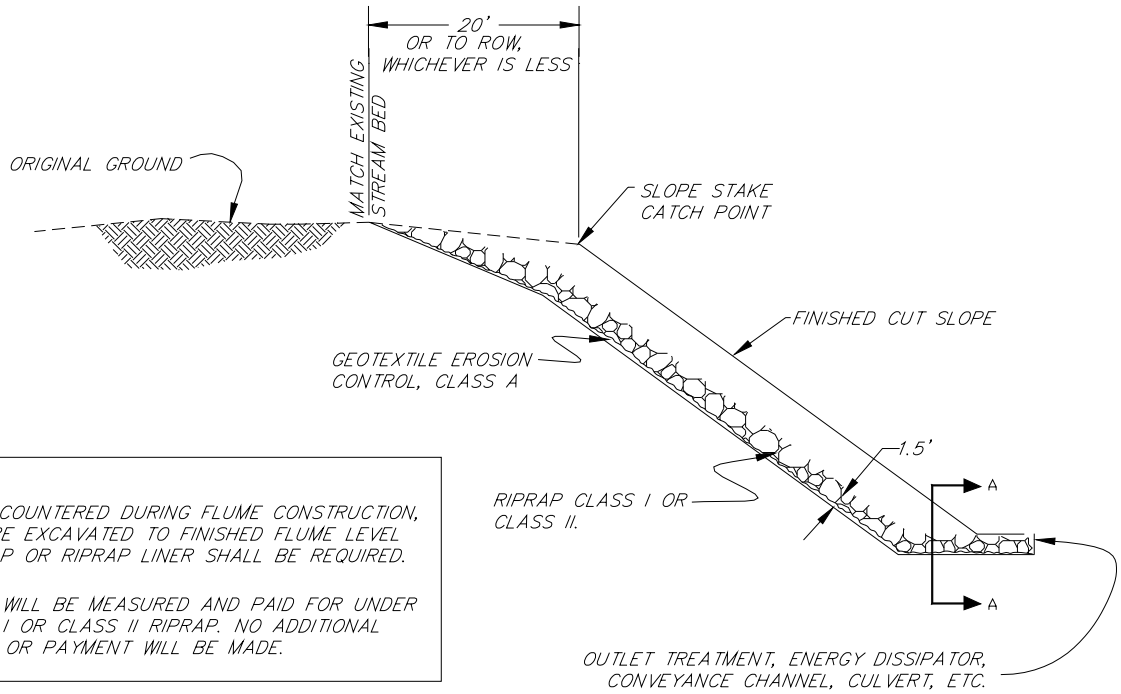

- NOTES:
1. IF ROCK IS ENCOUNTERED DURING FLUME CONSTRUCTION, ROCK SHALL BE EXCAVATED TO FINISHED FLUME LEVEL AND NO RIPRAP OR RIPRAP LINER SHALL BE REQUIRED.
  2. ROCK FLUMES WILL BE MEASURED AND PAID FOR UNDER EITHER CLASS I OR CLASS II RIPRAP. NO ADDITIONAL MEASUREMENT OR PAYMENT WILL BE MADE.

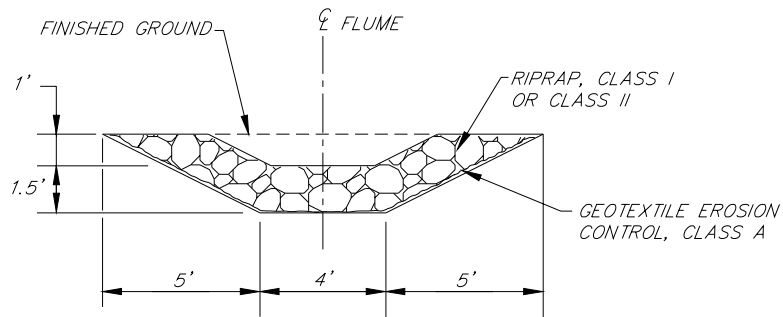

SECTION A-A

ROCK FLUME DETAIL

**Rock Flume**

## Outlet Protection

### Objectives and Applications

An outlet protection is a structure designed to control erosion at the outlet of a pipe by reducing flow velocity and dissipating flow energy.

This measure should be used where the discharge velocity of a pipe exceeds the tolerances of the receiving channel or disposal area. To prevent scour and undermining, an outlet protection structure is needed to absorb the impact of the flow and reduce the velocity to non-erosive levels. A riprap lined apron is the most commonly used practice for this purpose because of its low cost and ease of installation. Designs will vary based on discharge specifics and receiving stream conditions. Outlet Protection may be temporary or permanent.

**Common Failures** - *Generally due to faulty design, installation or maintenance.*

- Inadequate apron length, resulting in scouring
- Riprap rock that is too small for runoff velocities

### Other Considerations

- The riprap apron should be extended downstream until stable conditions are reached even though this may exceed the length calculated for design velocity control
- If the pipe discharges into a well defined channel, the side slopes of the channel shall not be steeper than 1:2 (horizontal:vertical)
- Riprap stilling basins or plunge pools should be considered in lieu of aprons where pipe outlets are perched or where high flows would require excessive apron length. Design guidelines for stilling basins can be found in Hydraulic Design of Energy Dissipators for Culverts and Channels, Hydraulic Engineering Circular No. 14, USDOT, FHWA (1983).

### Relationship to Other ESC Measures

Outlet protection may be installed at the discharge points of grassed waterways or swales, storm water conveyance channels, sediment basins, and wet ponds.

### Alternate Sediment Control Measures

Other structural energy dissipators, such as riprap stilling basins, baffle wall basins or T-fitting on the end of corrugated metal pipe.

### Other Names

Stabilized Outlet.

### Design

**Capacity:** *2 year peak runoff or the design discharge of the water conveyance structure, whichever is greater. Determine the maximum allowable velocity for the receiving stream, and design the riprap apron to reduce the flow to this velocity*

**Apron Length:** *The apron length shall be six times the diameter of the outlet pipe.*

**Apron Width:** *The apron width shall be four times the diameter of the outlet pipe.*

**Materials:** *The apron should be lined with riprap. The riprap should consist of a well-graded mixture of stone, with larger stones predominating. The diameter of the largest stone shall be no greater than the 1.5 times the median stone size. Geotextile filter cloth shall be placed between the riprap and the underlying soil.*

**Grade:** *The apron shall be less than or equal to the receiving channel grade, preferably a flat (0%) slope. Steeper grades may require alternative measures such as riprap stilling basins, or other energy dissipators.*

**Alignment:** *The apron shall be straight throughout the entire length.*

**Additional Design Guidelines:** *Hydraulic Design of Energy Dissipators for Culverts and Channels, Hydraulic Engineering Circular No. 14, USDOT.*

### Materials

Rock riprap; geotextile filter cloth.

### Installation

Ensure that the subgrade for the filter and riprap follows the required lines and grades shown in the plan.



Compact any fill required in the subgrade to the density of the surrounding undisturbed material. The riprap must conform to the specified grading limits shown on the plan. Filter cloth must meet the design requirements and be properly protected from punching or tearing during installation.

Riprap may be placed by equipment, but take care not to damage the filter cloth. Ensure that the riprap consists of a well-graded mixture of stones. The diameter of the largest stone should be no greater than 1.5 times the median stone size. The minimum thickness of the riprap apron should be 1.5 times the maximum stone diameter. Riprap may be field stone or rough quarry stone, and should be hard, angular, weather resistant, and well graded. Make the top of the riprap at the downstream end level with the receiving area or slightly below it. Ensure that the apron is properly aligned with the receiving stream and preferably straight throughout its length. If a curve is needed to fit site conditions, place it in the upper section of the apron. Stabilize all disturbed areas with vegetation immediately after construction.

### **Inspection**

Inspect outlet protection weekly and after heavy rains to look for erosion around or below the riprap, dislodged stones, and scouring. Outlet protection should also be monitored for sediment accumulation filling the voids between rocks

### **Maintenance**

Make immediate repairs if any conditions noted under inspection are found. Sediment should be removed when it fills the voids between rocks.

### **Removal**

Restore ground to existing or constructed grade. Revegetated measures may be left in place only if specifications specifically allow it.

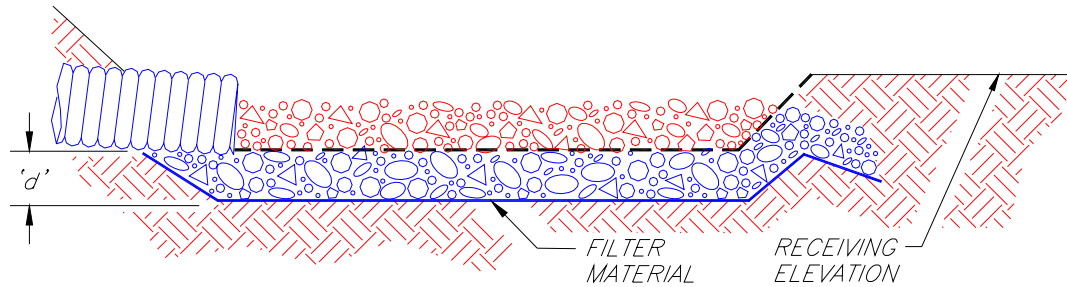

THICKNESS ('d') = 1.5 x MAX. ROCK DIAMETER - 6" MIN.

### SECTION

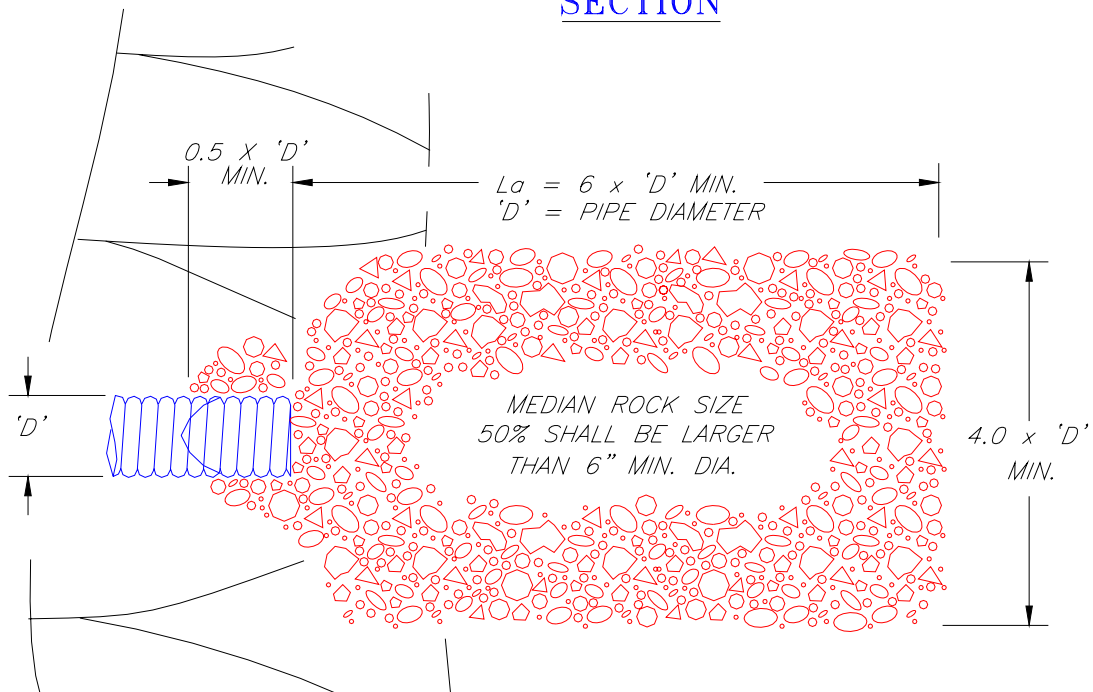

### PLAN

**NOTES:**

1. 'La' = LENGTH OF APRON. DISTANCE 'La' SHALL BE OF SUFFICIENT LENGTH TO DISSIPATE ENERGY.
2. FILTER MATERIAL SHALL BE FILTER FABRIC OR 6" THICK MINIMUM GRADED GRAVEL LAYER.

1994 JOHN McCULLAH



FILE: ENRGYDIS

## OUTLET PROTECTION

## **Storm Water Conveyance Channel**

### **Objectives and Applications**

A channel lined with vegetation, riprap, or other flexible material designed for the conveyance and safe disposal of concentrated surface runoff to a receiving system without damage from erosion.

The main design considerations are the volume and velocity of the water expected in the channel. All conveyance channels should be designed to carry at least the appropriate peak flow. Other factors to be considered include availability of land, aesthetics, safety, maintenance requirements, and soil characteristics. There are two types of cross sections for channel linings, trapezoidal and triangular (“V” shaped). All channels should discharge through a stabilized outlet that should be designed to handle the expected runoff velocities and volumes from the channel without resulting in scouring.

Channel linings function to protect drainage channels against erosion through the use of flexible linings (vegetation, riprap, gravel, or flexible, porous mats), and may be used as either a temporary or a permanent sediment control measure. The selection of a type of lining should be based upon the design flow velocities.

**Common Failures** - *Generally due to faulty maintenance.*

- Sediment accumulation – channel capacity is reduced, resulting in over topping and erosion
- Failure of lining

### **Other Considerations**

- Channels should be located to conform with and use the natural drainage system.
- Grass lined channels should not be subject to sedimentation from disturbed areas.
- Grass-lined channels may be unsuitable if channel slopes over 5% predominate, continuous or prolonged flows occur, potential exists for damage from traffic (people or vehicles), or soils are erodible.
- Channel side slopes should be 2:1 or flatter in the case of rock-riprap lining. Vegetated channel side slopes should be 4:1 or flatter.

- When using riprap as a liner, a geotextile filter blanket or one or more layers of granular filter should be placed before placing the riprap. The thickness and gradation of the granular filter, or specifications for the geotextile, should be included in the plans.
- Vegetation in grass lined channels should be established before flows are introduced.

### **Relationship to Other ESC Measures**

All channels should discharge through a stabilized outlet. The outlet should be designed so that it will handle the expected runoff velocities and volumes without scouring. An energy dissipator may be needed if flow velocities exceed the allowable velocity of the receiving channel.

### **Alternate Sediment Control Measures**

Grass Lined Swale

### **Other Names**

Channel Stabilization

### **Design**

*The following information is needed to design channel linings.*

- *Expected runoff peak flow*  
*Temporary: 2-year frequency storm*  
*Permanent: 10-year frequency storm*
- *Desired channel capacity*
- *Slope of the channel*
- *The type of cross-sectional design of channel*
- *The type of lining*
- *Design depth or design cross sectional area*

**Design Guidelines** – *Design procedures should be consistent with steps outlined in chapter 8.6.3.1 of the Alaska Highway Drainage Manual. Basic steps will include:*

1. *Establish a roadside plan*
2. *Obtain or establish cross section data*
3. *Determine initial channel grades*
4. *Check flow capacities and adjust as necessary*
5. *Determine channel lining/protection needed (following procedures in FHWA Hydraulic Engineering Circular No. 15, “Design of Roadside Channels with Flexible Linings”)*
6. *Analyze outlet points and downstream effects*

## **Materials**

Filter blanket or geotextiles, flexible, porous mats (fiberglass, plastic, or jute), staples, riprap, gravel, seed, fertilizer, mulch.

## **Installation**

Remove all unsuitable material, such as trees, brush, roots, or other obstructions prior to installation. Shape the channel to proper grade and cross-section as shown in the plans, with no abrupt deviations from design grade or horizontal alignment. Compact all fills to prevent unequal settlement. Remove any excess soil and dispose of properly.

**Grass lined channels** – Seed, fertilize and mulch.

**Riprap lined channels** – Place a geotextile filter blanket or a granular filter, prior to placement of riprap.

**Mat lined Channels** – Seed and fertilize. Apply the matting from the upper end of the channel and continue downgrade. Secure the top end of the matting by excavating a 6 in. trench, followed by back-filling and compacting. Overlap rolls of matting at least 6 in.. Excavate a 6 in. x 6 in. trench every 35 ft. and inset a fold of the mat into the trench. Staple securely on 6 in. centers, using minimum 6 in. long staples, then backfill and compact. Roll channel lining with a heavy roller after seeding, mat placement, and stapling are complete.

## **Inspection**

Inspect channels weekly as well as after major rains as for sediment accumulation, material displacement, bank failures, and scour at inlet and outlet sections.

## **Maintenance**

**Grass Lined Channels** – During the initial establishment, grass lined channels should be repaired immediately and grass re-established if necessary. After grass has become established, the channel should be checked periodically to determine if the grass is withstanding the flow velocities without damage. The channel should be repaired if scour is found to be present, and any debris or sediment accumulation should be removed.

**Riprap Lined Channels** – Riprap lined channels should be checked periodically to ensure that scouring is not occurring beneath the fabric underlying the riprap layer, or that the stones have not been displaced by the flow. Sediment should be removed from the riprap lined channel if it reduces the capacity of the channel.

**Mat Lined Channels** – Inspect channel linings following each major storm or snowmelt event and repair as necessary. If the desired grass has not become established through a mat, replace the matting, taking care not to disturb any areas of established grass.

## **Removal**

Temporary channels - Provide and compact fill to existing or constructed grade. Seed and mulch.

FREEBOARD HEIGHT (H), CHANNEL GEOMETRICS AND STONE SIZE SHALL BE DETERMINED BY THE ENGINEER

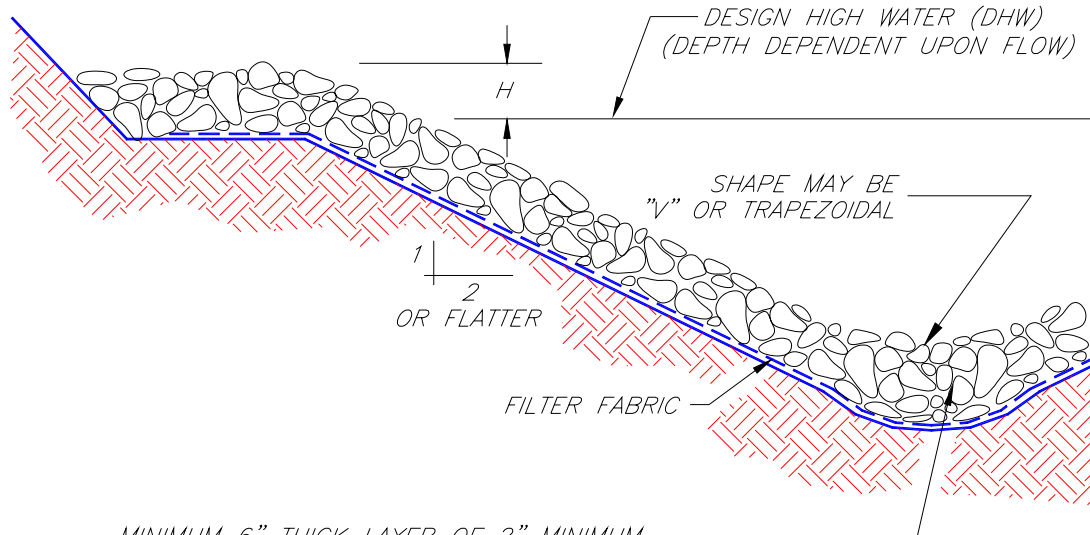

MINIMUM 6" THICK LAYER OF 2" MINIMUM DIAMETER DRAIN ROCK. LARGER STONE AND THICKNESSES SHALL BE USED DEPENDENT UPON GRADIENT, SOIL TYPE, AND DESIGN FLOW.

## TYPICAL SECTION

1994 JOHN McCULLAH



FILE: RCKCHNEL

## STORM WATER CONVEYANCE CHANNEL, RIPRAP

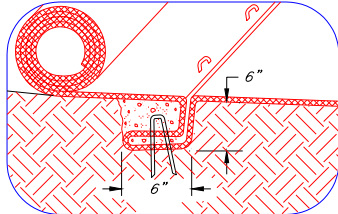
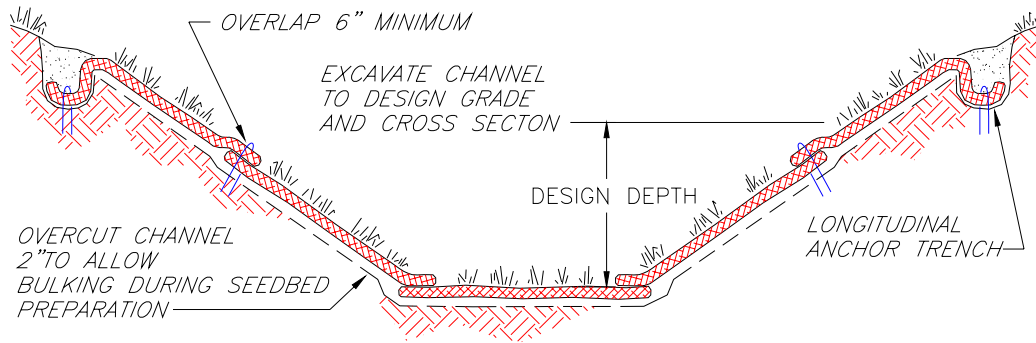

**INTERMITTENT CHECK SLOT**

TYPICAL INSTALLATION WITH EROSION CONTROL BLANKETS OR TURF REINFORCEMENT MATS

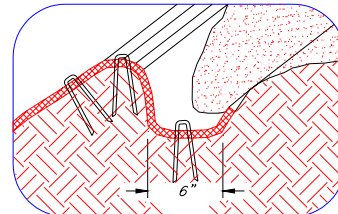

**LONGITUDINAL ANCHOR TRENCH**

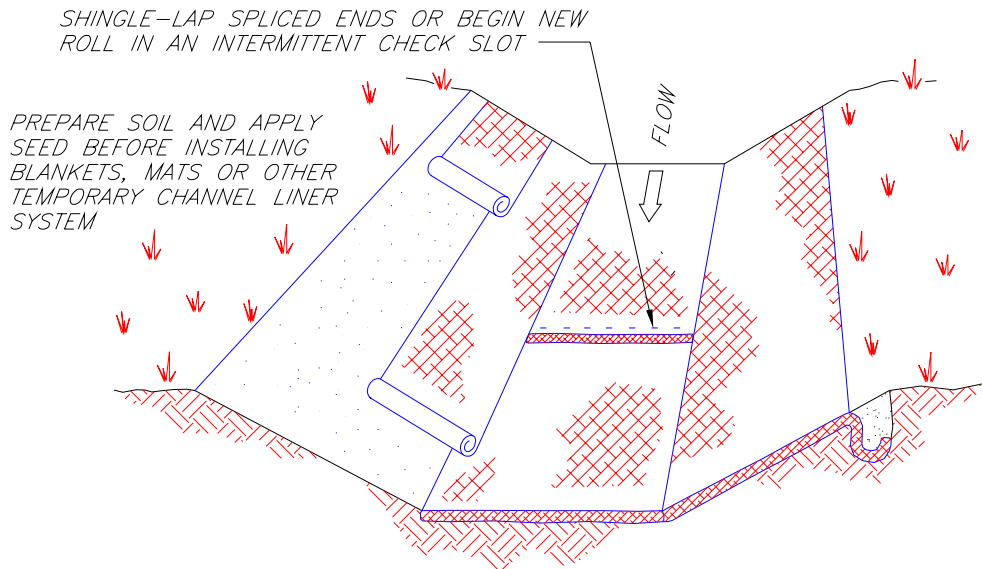

- NOTES:
- DESIGN VELOCITIES EXCEEDING 2.0 FT/SEC REQUIRE TEMPORARY BLANKETS, MATS OR SIMILAR LINERS TO PROTECT SEED AND SOIL UNTIL VEGETATION BECOMES ESTABLISHED.
  - GRASS-LINED CHANNELS WITH DESIGN VELOCITIES EXCEEDING 6.0 FT/SEC SHOULD INCLUDE TURF REINFORCEMENT MATS.

NOT TO SCALE

© 1996 JOHN McCULLAH

FILE: GRSSINST

**STORM WATER CONVEYANCE CHANNEL, MAT**

## **Rock Check Dam**

### **Objectives and Applications**

A rock check dam is an expedient (or emergency) temporary measure to protect narrow erosion-susceptible waterways and/or reduce the sediment loads in channeled flows. Check dams may also be used as permanent measures.

Temporary check dams are placed in series in ditches, swales, gullies, or other minor drainageways intended to be filled or stabilized at a later time. They are used to slow stormwater velocities and direct scouring flows away from channel surfaces. The dam configuration supports sediment settling from silted waters pooled behind the weir. Small sediment particles become lodged in the dam's interior.

Permanent check dams may be used as gradient control structures in ditches adjacent to elevated roadway sections.

**Common Failures** - *Check dams are vulnerable to failure from concentrated flow.*

- Undercut/washout of channel banks beside the structure due to improper installation (e.g. dam not built high enough onto the banks).
- Increased bank erosion (e.g. at channel bends) or inadequate protection of channel surfaces due to improper location or installation of check dams.
- Water backup and bank overflow due to overly tall dam structure.
- Rocks washed downstream may clog culverts, misdirect flow, etc.
- Check dams installed in grass lined structures may kill the vegetative lining if siltation is excessive or the dam remains submerged for extended periods of time.

### **Other Considerations**

- Coupling check dams with adjacent upstream sumps facilitates sediment removal.
- Rock check dams are used in narrow ditches and gullies. Straw bales are used primarily in wide swales.

- Rock check dams may be more costly to install than straw bale check dams.
- Check dam rocks interfere with the establishment of vegetation.
- Rock check dams left as permanent structures interfere with grass mowing (maintenance).
- Steep channel slopes reduce effectiveness.
- Coupling check dams with a small adjacent upstream sump improves velocity slowing and sediment trapping ability.
- The area downstream from the last dam should be stabilized or flow diverted.

### **Relationship to Other ESC Measures**

As part of the perimeter control ESC network, check dams are used for channel protection prior to establishment of permanent or stabilized erosion controls. Although check dams do some sediment filtering, they are not intended to replace filters or sediment basins. A depression in the bottom of the channel at the upstream edge of a check dam augments velocity slowing and sediment removal. Digging a sump through stabilized in-channel protection (e.g. grassed lining) should be avoided, however. Check dams interfere with localized vegetative channel protection. Rocks prohibit establishment of in-situ vegetation and the protective lining is subject to disturbance/ destruction during check dam removal.

### **Alternate Sediment Control Measures**

- Drainage diversion during channel stabilization.
- Protective channel linings (e.g. grassed waterway, concrete or rock-lined ditch, erosion control blankets or matings), straw bales, sediment settling ponds, permanent ditch blocks, sand bag check dams, brush barriers or combinations or these measures.

### **Other Names**

In Stream/Channel Energy Dissipator

## Design

The design of rock check dams (high at channel banks, lower in the middle) directs overtopping flows centrally to avert scouring of channel surfaces. The dam is keyed into channel slopes to prevent bank undercut and erosion.

Spacing between dams is based on waterway grade, height of adjacent check dams and desired length of backwater effect. The distance shown in the table below has been calculated for the protection of channel banks between successive structures. Placement of check dams at abrupt bends should be avoided since erosive waters could be misdirected by the check dam into channel banks.

Check dam structures are sized to stay in place during peak flow and should pass 2-year storm runoff without overtopping the roadway or ditch side-slopes. Generally, dams are not constructed higher than recommended as follows since excessive weir depth seriously impacts the flow characteristics of the ditch.

The following dimensions may be modified for site-specific applications:

### Standard Check Dam

**Maximum drainage area:** *not to exceed 10 acres*

**Normal flow velocity:** *no greater than 6 ft/sec.*

**Maximum height at dam center:** *not greater than 2 ft. or one half the channel depth*

**Minimum height difference between center and (bank) sides:** *6 in.*

**Structure slope:** *1:2*

**Maximum spacing between standard (2 ft. high) check dams:** *align top of check dam level with toe elevation of the upstream dam*

Channel Slope (%)				
2	3	4	5	6
Spacing (ft.)				
100	67	50	40	33

## Materials

Clean hard angular (e.g. crushed, shot) rock graded according to expected flows. Two- to three-inch stone is usually adequate.

Alternate materials: logs, brush and twigs, sandbags partially filled with pea gravel. Use only clean materials. Avoid introduction of fines.

## Installation

Install dams as soon as drainage routes are established. Place rock by hand or mechanical means, distributing smaller rocks to the upstream side to prevent transport. Check structures key into a trench that spans the complete width of the channel. Extend dams high onto the channel banks (above anticipated high water level) to prevent localized undermining and erosion. In unlined channels, a small sump dug at the upstream side of the dam facilitates sediment collection and removal.

## Inspection

Observe dam function during/after each rainfall event that produces runoff and note conditions of channel surfaces. Visually compare upstream and downstream flows to determine relative turbidity levels and effectiveness of velocity checks. Inspect channel banks for evidence of undermining and erosion. Look for dam deterioration and for migration of structural components downstream. Observe level of sediment buildup behind dam. It should not exceed ½ dam height. Observe ESC effectiveness during flows to determine if adjunct measures are needed. The dam should be stable and appropriately sized to withstand high velocity events.

## Maintenance

Repair check dam voids and bank undercuts. Fortify disintegrating dams and install additional dams or other ESC measures as needed. Correct undesirable effects of rock migration (e.g. clogged culvert, flow construction). Periodically remove sediment deposits.

## Removal

Care should be taken since the waterway surfaces are susceptible to damage during check dam removal. Damaged or unprotected areas should be seeded immediately or other forms of protection provided as warranted. Some check dams are left as a permanent control measure. Removal may be indicated because of unsightliness or interference with maintenance activities.



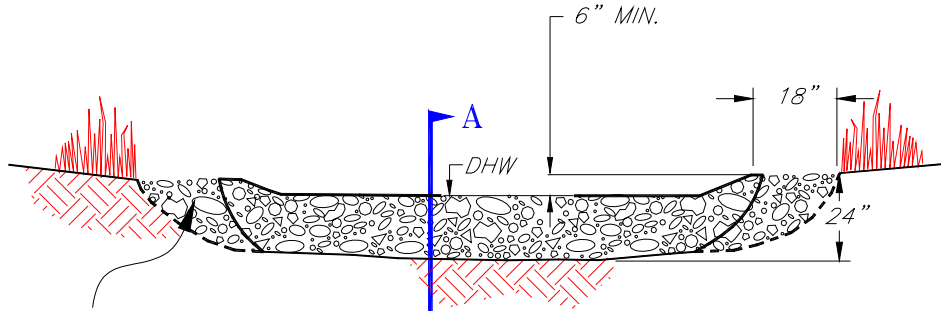

KEY STRUCTURE INTO CHANNEL BANKS  
AND EXTEND IT BEYOND THE ABUTMENTS  
A MINIMUM OF 18" TO PREVENT  
FLOW AROUND DAM.

### VIEW LOOKING UPSTREAM

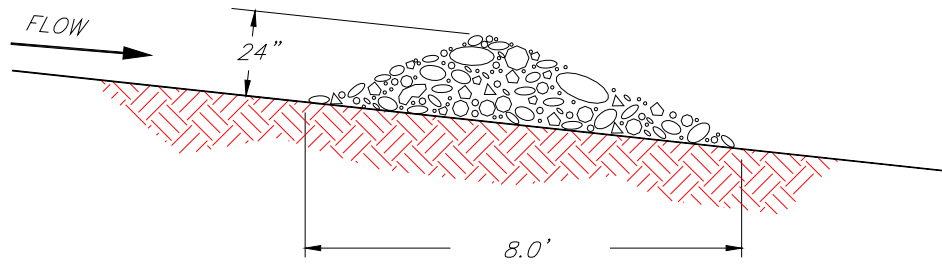

### SECTION A - A

'L' = THE DISTANCE SUCH THAT POINTS 'A' AND  
'B' ARE OF EQUAL ELEVATION.

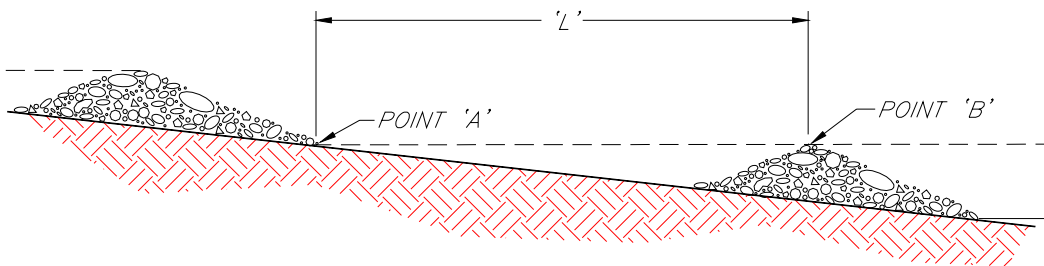

### SPACING BETWEEN CHECK DAMS

NOT TO SCALE

1994 JOHN McCULLAH

©

FILE: RCKCHKDM

### ROCK CHECK DAM

## **Mulching**

### **Objectives and Applications**

Mulching is the application of a uniform protective layer of straw, wood fiber, wood chips, or other acceptable material on or incorporated into the soil surface of a seeded area to allow for the immediate protection of the seed bed.

The purpose of mulching is to protect the soil surface from the forces of raindrop impact and overland flow, foster the growth of vegetation, increase infiltration, reduce evaporation, insulate the soil, and suppress weed growth. Mulching also helps hold fertilizer, seed, and topsoil in place in the presence of wind, rain, and runoff, and reduces the need for watering. Mulching may be utilized in areas that have been seeded either for temporary or permanent cover.

There are two basic types of mulches, organic mulches and chemical mulches. Organic mulches include straw, hay, wood fiber, paper fiber, wood/paper fiber blends, peat moss, wood chips, bark chips, shredded bark, manure, compost and corn stalks. This type of mulch is usually spread by hand or by machine (mulch blower) after seed, water, and fertilizer have been applied. Chemical mulches, also known as soil binders or tackifiers, are composed of a variety of synthetic materials, including emulsions or dispersions of vinyl compounds, rubber, asphalt, or plastics mixed with water. Chemical mulches are usually mixed with organic mulches as a tacking agent to aid in the stabilization process, and are not used as a mulch alone, except in cases where temporary dust and erosion control is required. Hydroseeding, sometimes referred to as hydromulching, consists of mixing a tackifier, specified organic mulch, seed, water, and fertilizer together in a hydrosurry and spraying a layer of the mixture onto a surface or slope with hydraulic application equipment. The choice of materials for mulching should be based on soil conditions, season, type of vegetation, and the size of the area.

**Common Failures** - *Generally due to faulty installation or maintenance.*

- Mulches are not properly watered after application, resulting in drying out and possible blowing or washing away of materials.

- Depth of mulching material is either insufficient or excessive, resulting in low seed germination rates.
- Hydroseeding slurry not applied uniformly, resulting in spotty germination and inadequate ground cover.

### **Other Considerations**

- Mulch should be applied immediately after seeding to improve seed germination.
- Hydroseeding can be performed in one step, and is effective provided that materials are properly mixed and equipment is in good working order.
- Depth of the applied mulch should be not less than 1 in. and not more than 2 in.
- Chemical soil stabilizers or soil binders, when used alone, are less effective than other types of mulches. These products are primarily useful for tacking organic mulches.
- A tackifier should be used in conjunction with seeding, fertilizing, and mulching or hydroseeding on any slopes steeper than 3:1.
- Check labels on chemical mulches and binders for environmental concerns. Take precautions to avoid damage to fish, wildlife, and water resources.
- Some materials such as wood chips may absorb nutrients necessary for plant growth.

### **Relationship to Other ESC Measures**

Mulching may be performed in conjunction with seeding, fertilizing, surface roughening, and grading practices. Concentrated flows of runoff should be directed away from mulched areas.

### **Alternate Sediment Control Measures**

Erosion Control Blankets; Sodding

### **Other Names**

Hydromulching; Chemical Stabilization

### **Design**

**Design life:** *1 season (6 months) or less*

**Site applicability:** *Areas which have been disturbed and require temporary or permanent cover*

**Materials and application rates:** *as per Section 619 and Section 727 of Alaska Standard Specifications for Highway Construction, and Special Provisions for project*

## **Materials**

Most Commonly Specified Mulches – Wood Fiber, Paper Fiber, Wood/Paper Fiber Combination Blends, Peat Moss

Other Mulches – Straw, Hay, Wood Chips, Bark Chips, Shredded Bark, Corn Stalks, Compost, Manure

Tackifiers – Vinyl Compounds, Rubber, Asphalt, or Plastics mixed with water

## **Installation**

Complete the required grading as shown on the plans and ensure that erosion control measures intended to minimize runoff over the area to be mulched are in place. Apply mulch at the rates specified in the special provisions either by hand or by machinery immediately after the seed and fertilizer have been applied (two step method), or as part of the hydroslurry incorporating seed, fertilizer, mulch, and water (one step method). Apply specified tackifier if not already incorporated into the mulch matrix or hydroslurry. Provide additional watering as specified to ensure optimal seed germination conditions.

## **Inspection**

Inspect all mulches weekly and after each rainstorm to check for rill erosion, dislocation, or failure as.

## **Maintenance**

Replace mulch that has been loosened or dislodged. In addition, reseed areas if necessary. Water mulched areas periodically to ensure that moisture content will be maintained and seed germination and grass growth will continue.

## **Removal**

Mulching is usually left in place to naturally decompose and become part of the soil structure.

## **Temporary Seeding**

### **Objectives and Applications**

To establish a temporary vegetative cover on disturbed areas by seeding with appropriate and rapid growing annual grasses, usually annual ryegrass.

The purpose of temporary seeding is to stabilize the soil and reduce damage from wind and/or water until permanent stabilization is accomplished. Seeding is applicable to areas that are exposed and subject to erosion for more than 30 days, and is usually accompanied by surface preparation, fertilizer, and mulch. Temporary seeding may be accomplished by hand or mechanical methods, or by hydraulic application (hydroseeding), which incorporates seed, water, fertilizer, and mulch into a homogeneous mixture (slurry) that is sprayed onto the soil.

**Common Failures** - *Generally due to faulty installation or maintenance.*

- Seed is not properly watered after application, resulting in drying out and low germination rates.
- Depth of mulching material is either insufficient or excessive, resulting in low seed germination rates.
- Hydroseeding slurry is not applied uniformly, resulting in spotty germination and inadequate ground cover.

### **Other Considerations**

- Proper seed bed preparation and the use of high quality seed are essential to the success of this practice.
- Temporary seeding should take place as soon as practicable after the last ground-disturbing activities in an area.
- Once seeded, protect the area from foot and equipment traffic.
- Temporary seeding is not recommended if permanent seeding will be completed in the same growing season. Other temporary stabilization measures should be considered.

### **Relationship to Other ESC Measures**

Seeding should be performed in conjunction with mulching, fertilizing, surface roughening, and grading practices. Concentrated flows of runoff should be directed away from seeded areas using diversions.

### **Alternate Sediment Control Measures**

Erosion Control Matting, Plastic Sheetting

### **Other Names**

Temporary Stabilization

### **Design**

**Seed Selection:** *Annual Ryegrass(Lolium multiflorum)*

**Seed Application Rate:** *60 lbs/acre (average rate, site specific conditions may require more or less)*

**Fertilizer Application Rate:** *600 lbs/acre 20-20-10 (nitrogen-phosphorous-potassium [average rate, site specific conditions may require more or less])*

### **Materials**

Seed, water, fertilizer, mulch

### **Installation**

Grade as needed where it's feasible to permit the use of equipment for seedbed preparation. Prepare the seedbed by using surface roughening if soil has been compacted by machinery or heavy foot traffic. If using hand or mechanical methods, apply fertilizer in order to optimize growing conditions, followed by seed, mulch, and water. If using hydroseeding, mix seed, mulch, fertilizer, and water as per the manufacturers recommendations. Apply slurry as per the manufacturer's recommendations.

### **Inspection**

Inspect newly seeded areas on a regular basis and after each storm event to check for areas where protective measures (mulch) have failed or where plant growth is not proceeding at the desired rate.

**Maintenance**

Water seeded areas daily until initial ground cover is established if rainfall does not provide moisture for seed germination. Reseed areas where growth is absent or inadequate. Provide additional fertilizer if needed.

**Removal**

Removal of temporary vegetation is usually not necessary. Continue inspections and remedial action until the site is stabilized by permanent vegetation.

## **Surface Roughening and Terracing**

### **Objectives and Applications**

Surface roughening and terracing includes establishing a rough soil surface by creating horizontal grooves, furrows, depressions, steps, or terraces running parallel to the slope contour over the entire face of the slope.

These measures are intended to aid in the establishment of vegetative cover from seed, to reduce runoff velocity and increase infiltration, and to reduce erosion and provide for sediment trapping. They provide simple, inexpensive and immediate short-term erosion control for bare soil where vegetative cover is not yet established. A rough, loose soil surface gives a mulching effect that provides more favorable moisture conditions than hard, smooth surfaces that aids in seed germination. The measure chosen to achieve these goals depends on the grade of the slope, the type of slope (cut or fill), soil and rock characteristics, future mowing and maintenance requirements, and type of equipment available. The most common measures utilized include:

Tracking – This is done by running machinery (such as bulldozers) up and down slopes to leave horizontal depressions in the soil, and is generally limited to sandy soils in order to avoid undue compaction of the soil surface.

Groove Cutting – This is done by cutting serrations along the contour with a blade attached to a dozer or other equipment.

Contour Furrows – This is done by cutting furrows (a series of ridges and depressions) along the contour of a slope, and is applicable to any area that will safely accommodate disks, tillers, spring harrow, or the teeth of a front end loader.

Stair Step Grading – This is done by cutting “steps” along the contour of a slope, and is applicable to slopes with a gradient greater than 3:1 which have material soft enough to be bulldozed and which will not be mowed.

Gradient Terracing – This is done by constructing earth embankments or ridge and channels along the face of a slope at regular intervals to intercept

surface runoff and conduct it to a stable outlet. This measure is applicable to long, steep slopes where water erosion is a problem, and should not be constructed in areas with sandy or rocky soils.

**Common Failures** - *Generally due to faulty installation or maintenance.*

- Roughening washed away by heavy rain, necessitating reroughening and reseeding.
- Failure of upslope control measures (diversions), resulting in excessive flows over area and erosion of soil.

### **Other Considerations**

- These measures are of limited effectiveness in anything more than a moderate storm.
- These measures may not be suitable for noncohesive or highly erodible soils.
- All fills should be compacted to reduce erosion, slippage, settlement, subsidence, and other related problems.
- The finished cut and fill slopes to be vegetated should not exceed 2:1.
- Use slope breaks, such as diversions, benches, or contour furrows to reduce the length of cut and fill slopes to limit sheet and rill erosion.

### **Relationship to Other ESC Measures**

Diversions at the upper perimeter of the area function to prevent runoff from causing erosion on the exposed soil. Silt fences and sediment basins at the lower perimeter of the area function to prevent off site sedimentation.

### **Alternate Sediment Control Measures**

Erosion Control Blankets

### **Other Names**

Contour Grading, Serration

### **Design**

**Measure Applicability:** *Construction slopes greater than 5 vertical feet.*

**Measure Selection:** *Should be determined by slope grade, soil type, mowing requirements, and slope type (cut or fill).*

## **Materials**

Construction equipment (bulldozer, front end loader, crawler tractor).

## **Installation**

### Cut Slope Roughening (Areas Not To Be Mowed)

Stair step grade or groove cut slopes that are steeper than 3:1. Use stair step grading on any erodible material soft enough to be ripped with a bulldozer. Slopes consisting of soft rock with some subsoil are particularly suited to stair step grading. Make the vertical cut distance less than the horizontal distance, and slightly slope the horizontal position of the “step” in toward the vertical wall. Do not make individual vertical cuts more than 2 ft. high in soft materials or more than 3 ft. high in rocky materials. Groove the slope using machinery to create a series of ridges and depressions that run across the slope, on the contour.

### Fill Slope Roughening (Areas Not To Be Mowed)

For slopes greater than 3:1, ensure that the face of the slope consists of loose, uncompacted fill 4 in. – 8 in. deep. Use contour furrows or tracking to roughen the face of the slope, if necessary. Do not blade or scrape the final slope face.

### Cuts, Fills, And Graded Areas (To Be Mowed)

Make mowed slopes no steeper than 3:1. Roughen these areas with shallow grooves by using tilling, disking, or harrowing implements. Make grooves close together, less than 12 in., and not less than 1 in. deep. Avoid excessive roughness on areas to be mowed.

### Roughening With Tracked Machinery

Limit roughening with tracked machinery to sandy soils in order to avoid undue compaction of the soil surface. Operate machinery up and down the slope to leave horizontal depressions in the soil. Do not back blade during the final grading operation.

## **Inspection**

Inspect the areas every week and after each rainfall that produces runoff during construction operations.

## **Maintenance**

Seed, fertilize, and mulch areas which are graded as quickly as possible. Regrade and reseed immediately if rills appear.

## **Removal**

Surface roughening and gradient terracing will remain an integral part of the slope after final stabilization with vegetation.

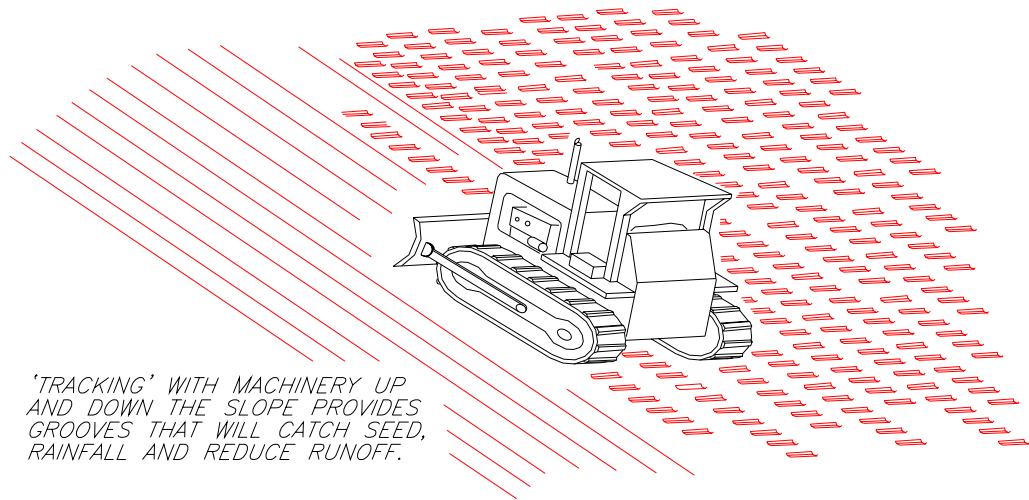

## TRACKING

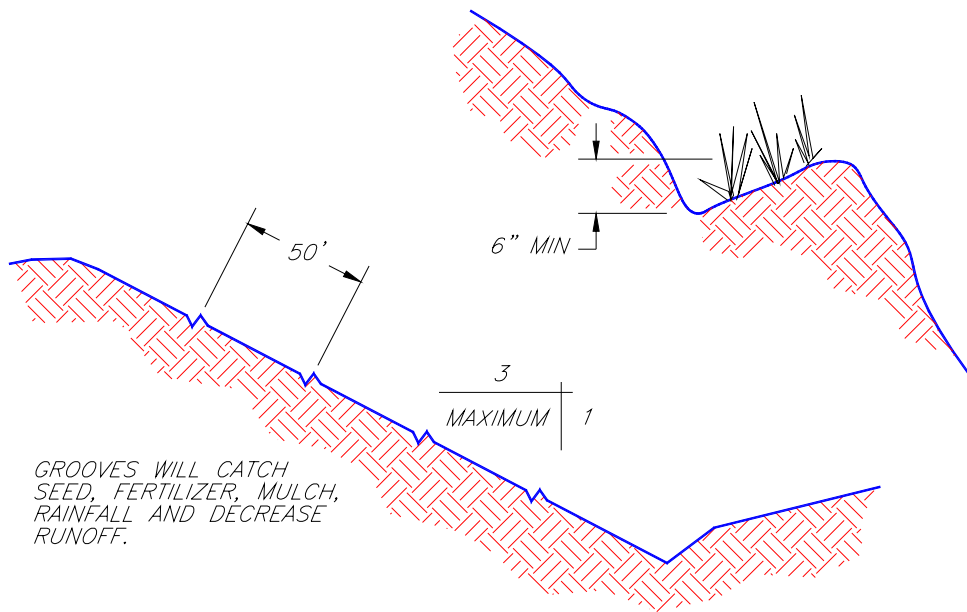

## CONTOUR FURROWS

1994 JOHN McCULLAH



FILE: SRFROUGH

## **SURFACE ROUGHENING AND TERRACING**



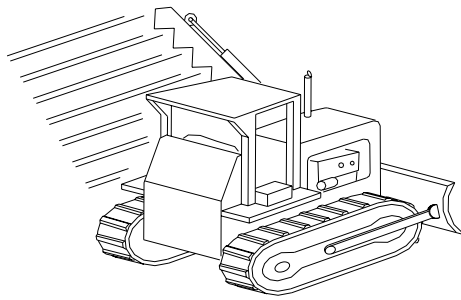
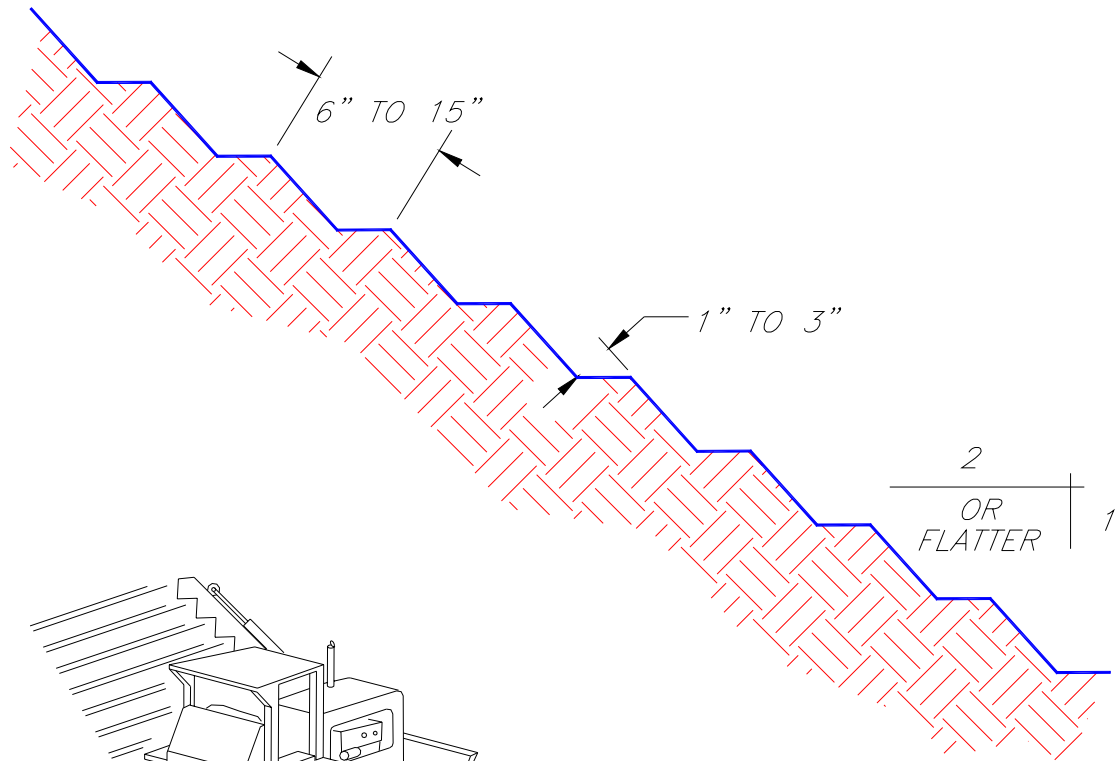

NOT TO SCALE

**NOTE:**

*GROOVE BY CUTTING SERRATIONS ALONG THE CONTOUR. IRREGULARITIES IN THE SOIL SURFACE CATCH RAINWATER, SEED, MULCH AND FERTILIZER.*

1994 JOHN McCULLAH



FILE: SERSLOPE

## **SURFACE ROUGHENING AND TERRACING**

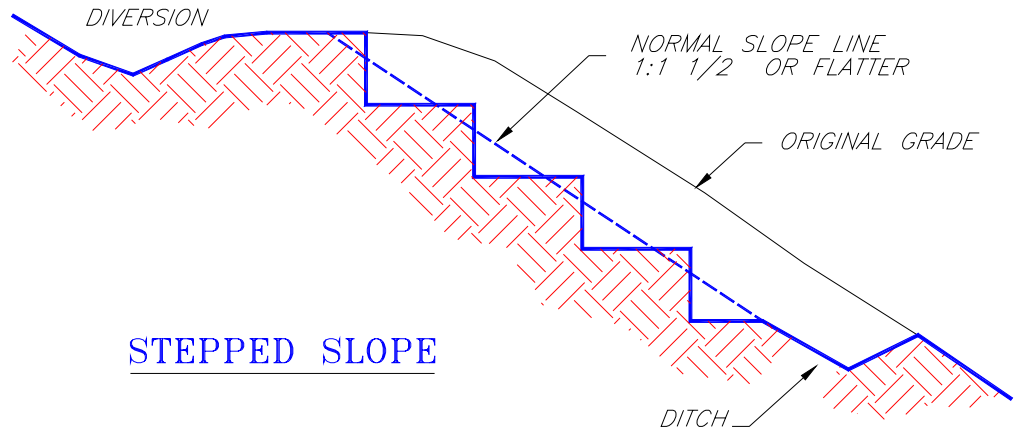

**STEPPED SLOPE**

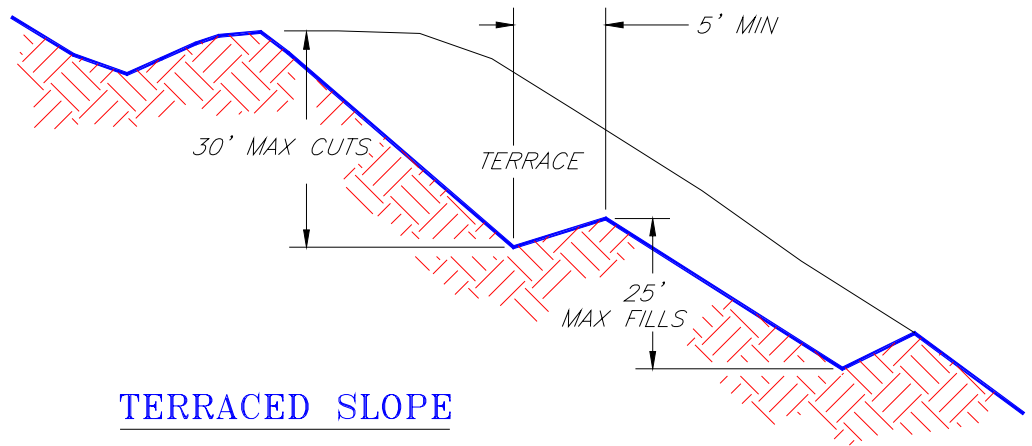

**TERRACED SLOPE**

*NOT TO SCALE*

**NOTES:**

1. VERTICAL CUT DISTANCE SHALL BE LESS THAN HORIZONTAL DISTANCE.
2. VERTICAL CUT SHALL NOT EXCEED 2 FT IN SOFT MATERIAL AND 3 FT IN ROCKY MATERIAL.

© 1994 JOHN McCULLAH

FILE: STPSLOPE

**SURFACE ROUGHENING AND TERRACING**

## **Rolled Erosion Control Products**

### **Objectives and Applications**

Rolled erosion control products (RECPs) are manufactured long sheets or coverings that can be unrolled onto unvegetated cut or fill slopes where erosion control or soil stabilization is needed. They are used where temporary seeding and mulching alone are inadequate, or where mulch must be anchored and other methods such as crimping or tackifying are unfeasible. There are many types of RECPs—and an ever-changing array of new products and manufacturers' claims. Applications range from coverings for temporarily inactive construction sites to long term protection of steep slopes.

### **Common RECP categories include:**

**Temporary RECP** *designed for short term use--e.g. up to 1 year.*

**Degradable** (generally preferred and more prevalent) *made from naturally decomposing materials.* Different fibers yield different characteristics and breakdown patterns. RECPs are either:  
*photodegradable*—broken down by sunlight exposure or  
*biodegradable*—deteriorated by action of biological organisms.

Erosion control blanket (ECB): matrix of long-fibered mulch held by netting on one or both sides or sewn through the filler. Common ECB mulches are straw, wood shavings (excelsior), flax, coconut fiber (coir) and jute.

Jute matting: woven jute fiber mesh.

Netting: fixative mesh cover to keep mulch in place. Made of cotton, jute, coir or photodegradable plastics. Opening sizes vary by design purpose.

**Non-degradable** *does not decompose with exposure to the elements*

Plastic sheeting occasionally used for urgent, short-term protective treatment or for overwintering disturbed slopes.

**Semi-permanent RECP** *lasts 4-8 years--commonly made from coir products*

**Permanent RECP** *does not decompose for 10 years or more*

Synthetic Turf Protection Mat: mechanically, structurally or chemically bound continuous mesh of processed or polymeric fibers. Mats are thick, heavy, long lasting. Some are designed to structurally support vegetation.

**Common Failures** - *Generally due to faulty installation or maintenance.*

- Seed washout/soil erosion due to water flow beneath poorly secured RECPs.
- Failed/inhibited growth of vegetative cover.
- Unintended RECP destruction by equipment, the elements, wildlife etc.

### **Other Considerations**

- Expensive RECPs aren't necessarily more effective than lower cost RECPs.
- Installation requirements, surface features & preparation, installer experience.
- RECP features; suitability constraints, strength, durability, degradation rate.
- Vegetation viability practices including: soil, temperature, insulation and sunlight requirements for plant species; site suitability including topsoil adequacy; fertilizer/growth-enhancer needs; moisture and timing requirements for germination and plant growth; over-saturation; destructive moisture levels cause seed/plant mold/mildew/rot.
- RECP seasonal durability; e.g. overwintering plastic sheeting tears.
- Ease of RECP puncture (desirable for bio-remedial shoot penetrations).
- Slope length and steepness relative to vegetative support & blanket saturation, weight and durability.

- Runoff velocities, volumes, moisture infiltration rates.
- Compatibility and interaction with other on-site erosion measures. E.g. plastic netting and mattings don't retain moisture or heat useful for germination enhancement; plan means to disperse snow accumulations or high runoff volumes at the toe of plastic covered slopes.
- Visual impact, including public's perception of erosion protection needs and available levels/sophistication of erosion technologies.
- Compatibility with land use (e.g. urban or well-populated sites).
- Interactions with wildlife: habitat, susceptibility to foraging, grazing, nesting

### Relationship To Other ESC Measures

RECPs can complement seeding and revegetation. Byproducts of RECP decomposition add mulch benefits and soil enhancement. RECPs can be used in conjunction with benching or other runoff velocity slowing or redirecting measures. RECPs aid dust control.

### Alternate Sediment Control Measures

Stabilization measures for vegetation preservation. Crimped, tracked or tackified mulches. Benching, terracing, diversions or other means to reduce slope steepness, length and runoff velocity and volume.

### Other Names

Terms used interchangeably: e.g. matting, blanket, sheet. Specified names e.g. Erosion Control Geotextile, ECB, Straw blanket, Mulch Mat

### Design

Consult product distributors for recommendations regarding RECP selection and performance criteria suitable for site-specific parameters. Evaluate:

- Duration of need--*Temporary* (e.g. 2 mo., 6 mo., 1 yr.) vs. *Permanent* (2-10 yrs.)
- Slope length
- Slope gradient (e.g. less than 1:1, 1:2, 1:3 or steeper)

- Soil type & erodibility
- Seasonal temperature & weather patterns; regional precipitation distribution
- Vegetation needs, especially where germination conditions are not optimal

Blankets: on grades > 2:1 are subject to high stresses.

Synthetic turf protection mat: distributes loads across (saturated) fill slopes and reinforce root systems. Use where slope protection is needed at least 2 years. Use on highly erodible slopes (>3:1), for steep slide rehabilitation, for heavy/high velocity runoff, landfill or high elevation reclamations, drought areas, long cut/fill slopes, bridge abutments etc.

Plastic sheeting 6 mil or thicker: Not recommended as cover for seeded slopes.

Wood fiber mat: drawbacks: bulky, difficult to place, 10–20% less effective erosion control than other mat types. May need to replace soil nitrogens leached by degrading wood.

Netting: Plastic netting doesn't hold heat or moisture, may require increased thickness of netted straw mulch 25%. Plastic netting and wood fiber mulches alone should not be used where runoff water flow exceeds 7 ft./sec.

Jute matting: Apply alone for seed germination enhancement or dust control, but not where runoff is significant.

### Materials

**Matting**: Burlap, Jute Mesh Fabric, Woven Paper or Sisal Mesh Netting, Knitted Straw Mat, Woven/ Curled Wood Blanket.

**Anchors**: U-shaped wire staples, triangular wooden stakes, willow stakes.

**Staples**: U-shaped steel wire (normally 8 in. long, 1 in. wide, 11 gage or heavier, a 12-in. length, 9 gage or heavier).

## **Installation**

RECPs -Excavate a 6" X 6" check slot trench at a level area well behind the slope crest or slopetop berm. Backfill and tamp over RECP roll end, leaving no gaps to allow under-blanket runoff invasion. Unroll sheeting downslope, parallel to grade and runoff path. Midslope splicings overlap successive sheets in the direction of flow so that upslope ends extend past the trench 16" anchoring the next downslope section. Stagger adjacent splicings. Anchor RECP terminal ends in slope toe key trenches and repeat the entire process until the entire slope has continuous coverage.

Lay RECPs to follow ground contours closely but do not stretch taut across surface depressions. Staple RECPs to maintain firm contact with underlying surfaces. Staple patterns vary depending upon slope length, grade, soil type and runoff rates. Staple blanket perimeters at no less than 12 in. intervals across the top and 3 ft. spacings along RECP sides and bottom. Staple intervals should be sufficient to prevent runoff flows beneath the blanket. Staple through 5 in. adjacent overlaps strips and staple every 3 ft. down sheet centerlines. Adjacent staple lines should stagger.

**Plastic Sheeting** - Anchor in slopetop trench (as above) to seal from runoff flow beneath sheeting. Duct tape 18 in. overlap seams to seal against wind and rain. Cover the entire exposed area. Hold sheets close to slope by suspending weights (tires, sandbags etc.) from ropes affixed to uphill anchors set no more than 10 ft. apart. Secure so wind doesn't lift the cover, expose slopes or tear plastic.

## **Inspection**

Check that surfaces adhere, fasteners remain secure and covering is in tight contact with soil surface beneath. Look for damaged areas and exposed soil surfaces. Pay special attention to seams and uphill edges.

## **Maintenance**

Repair, re-anchor, reinstall or replace matting. Re-seed where needed. It is especially important to protect overwintering plastic covered slopes, since the saturated soils may be easily erodible upon thaw.

## **Removal**

Non-degradable RECPS must be removed manually when no longer useful and disposed at an offsite landfill or by other approved methods. Degradable RECPs naturally deteriorate over time and can add soil enrichment.

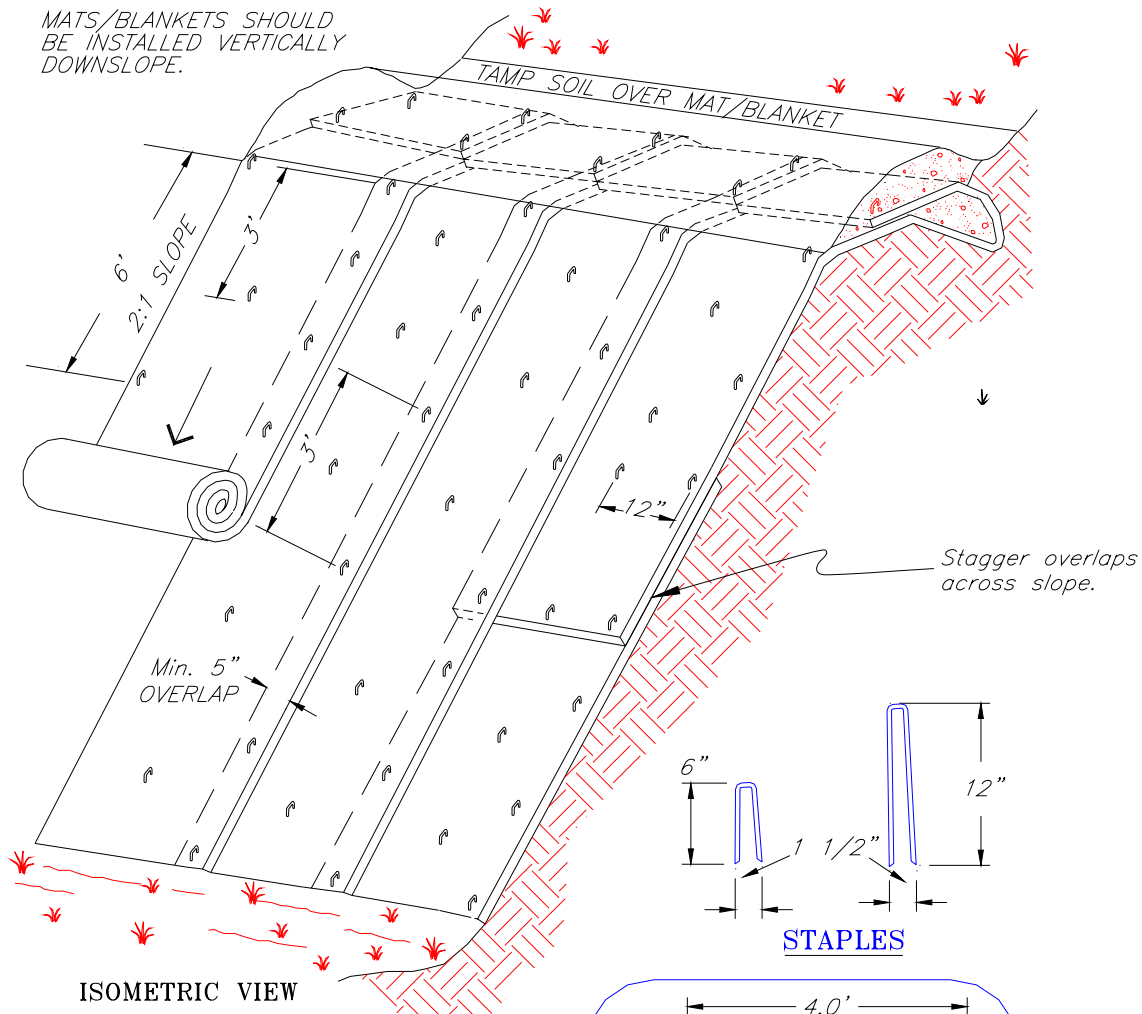

**TYPICAL SLOPE  
SOIL STABILIZATION**

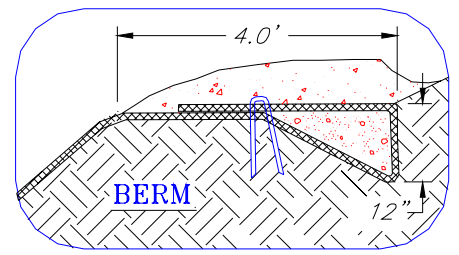

NOT TO SCALE

- NOTES:
1. SLOPE SURFACE SHALL BE FREE OF ROCKS, CLODS, STICKS AND GRASS. MATS/BLANKETS SHALL HAVE GOOD SOIL CONTACT.
  2. APPLY PERMANENT SEEDING BEFORE PLACING BLANKETS.
  3. LAY BLANKETS LOOSELY AND STAKE OR STAPLE TO MAINTAIN DIRECT CONTACT WITH THE SOIL. DO NOT STRETCH.

1994 JOHN McCULLAH

FILE: BLNKTSLP

**ROLLED EROSION CONTROL PRODUCTS**

## **Temporary Sediment Trap**

### **Objectives and Applications**

A temporary sediment trap is a small temporary ponding area, with a rock outlet, formed by excavating below grade and/or by constructing an earth embankment.

A sediment trap is a temporary structure that is used to detain runoff from small drainage areas so that sediment can settle out. Sediment traps generally are used for drainage areas less than five acres, and should be located in areas where access can be maintained for sediment removal and proper disposal. A sediment trap can be created by excavating a basin, utilizing an existing depression, or constructing a dam on a slight slope downward from a project area. Sediment laden runoff from the disturbed site is conveyed to the trap via ditches, slope drains, or diversion dikes. After being treated, the flow from the structure is controlled by a rock spillway. The trap is a temporary measure, with a design life of approximately six months, and is to be maintained until the site is permanently protected against erosion by vegetation and/or structures.

### **Common Failures** - *Generally due to faulty installation or maintenance*

- Inadequate spillway size; this results in overtopping of dam, poor trap efficiency, and possible failure of the structure.
- Low point in embankment caused by inadequate compaction and settling; this can result in overtopping and possible failure.
- Outlet not extended to stable grade; this can result in erosion below the dam.
- Spillway stone size too small or backslope too steep; this may result in stone displacement.
- Inadequate storage capacity; the sediment is not removed from basin frequently enough.

### **Other Considerations**

- The location of sediment traps should be determined based on the existing and proposed topography of the site.

- As a perimeter control, locate the trap where up to 5 disturbed acres drain to one location.
- Choose a location where maximum storage can be obtained from natural topography. This will minimize excavation.
- Locations should be selected where interference with construction activities will be minimized and will allow the trap to remain in service until the site is stabilized.
- The site must be accessible for future clean-out of the trap.
- Sediment traps are most effective at removing sand particles and are less effective at removing fine silt and clay particles. Longer retention times using engineered structures such as sediment basins or retention ponds may be necessary to remove these smaller particles.

### **Relationship to Other ESC Measures**

Sediment traps are usually located at the outlets of diversions, channels, slope drains, or other runoff conveyances that discharge sediment laden water.

### **Alternate Sediment Control Measures**

A sediment basin should be considered if the drainage area exceeds five acres. Sediment basins may be either temporary or permanent, and due to additional and more complex design and construction considerations, should be designed by a registered engineer.

### **Other Names**

Catch Basin

### **Design**

**Design life:** *1 season (6 months) or less*

**Contributing flow drainage area:** *not to exceed 5 acres*

**Storage volume:** *minimum 134 cubic yards per acre*

**Wet storage area depth:** *minimum 2 ft.- 3 ft., maximum 4 ft.*

**Ideal shape:** *rectangular and shallow trap, with a length to width ratio of 2:1 or greater*

**Berm:** *compacted earth, maximum height 5 ft.*

**Slopes (cut and fill):** *2:1 or flatter*

**Outlet:** *rock spillway, crest of spillway 1.0 ft. below top of embankment.*

<b>Spillway weir length (minimum)</b>	
<b>Drainage area (Acres)</b>	<b>Weir length (Feet)</b>
1 ac.	4 ft.
2 ac.	5 ft.
3 ac.	6 ft.
4 ac.	10 ft.
5 ac.	12 ft.

**Stone size:** *construct outlet using well graded stones with a median stone size of 9 in. and a maximum stone size of 14 inches. A 12-in. thick layer of 1/2 to 3/4 in. aggregate should be placed on the inside face to reduce seepage flow rate.*

### **Materials**

Filter fabric, coarse aggregate or riprap 2 inches to 14 inches in diameter; washed gravel 1/2 inch to 3/4 inch in diameter, seed and mulch for stabilization..

### **Installation**

Clear, grub, and strip the area under the berm of any vegetation and root mat. Clear the pool area to reduce debris buildup and facilitate cleanout. Excavate as required in the plan to obtain the necessary storage volume. Use fill material for the berm that is free of roots, other woody vegetation, organic materials, and large stones. Make all cut and fill slopes 2:1 or flatter. Compact the berm in 8 in. layers by traversing with construction equipment. Construct the rock spillway to the dimensions shown on the plan, placing filter fabric beneath the rock. Provide temporary or permanent stabilization (seed and mulch) on the berm immediately after the construction.

### **Inspection**

Inspect temporary sediment traps weekly and after each period of significant rainfall. Check the structure for damage from erosion, and check rocks in the outlet for clogging with sediment. Check the height of the stone outlet to ensure that the crest is at least 12 in. below the top of the berm.

### **Maintenance**

Remove sediment and restore trap to its original dimensions when the sediment has accumulated to one-half the design depth of the trap. Deposit sediment removed from the basin in a suitable area and in such a manner that it will not erode and cause sedimentation problems. Clean or replace the filter stone in the outlet structure if clogged with sediment. Adjust the height of the stone outlet if the crest is not at least 12 in. below the top of the berm.

### **Removal**

Remove sediment traps after the contributing drainage area is stabilized. Grade and stabilize the site of the sediment trap after removal as shown in the plans.



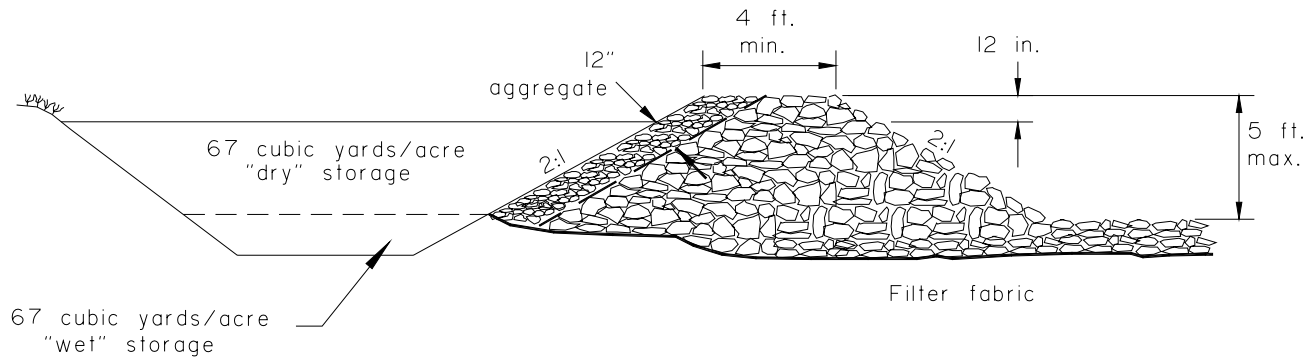

CROSS SECTION

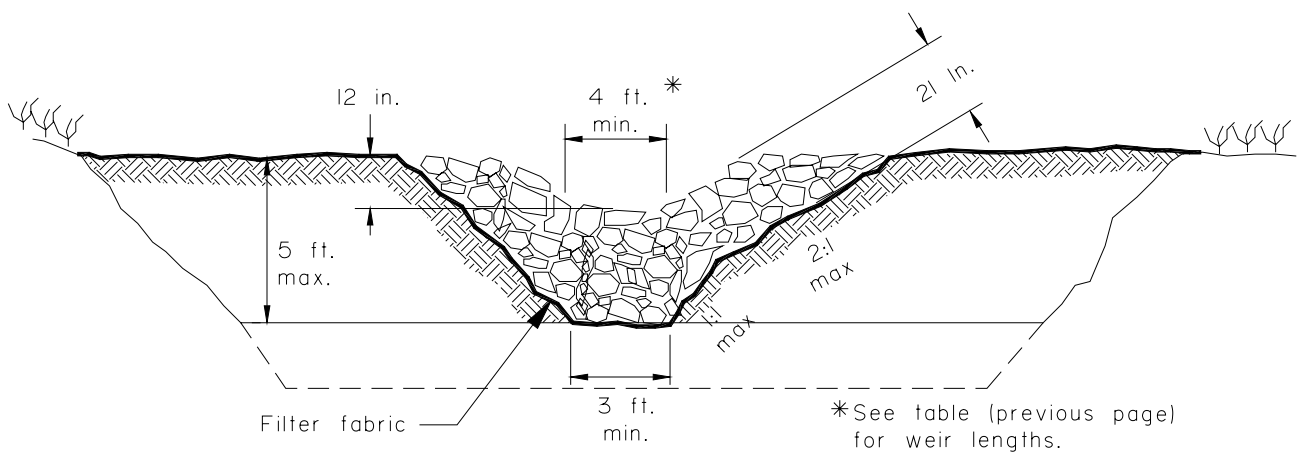

ELEVATION

**TEMPORARY SEDIMENT TRAP**

## **Vegetative Buffer Strip**

### **Objectives and Applications**

A vegetative buffer strip is an undisturbed area or strip of natural vegetation, or an established suitable planting that will provide a living filter to reduce soil erosion and runoff velocities.

Buffer strips act as living sediment filters that intercept and detain storm water runoff. They reduce the flow and velocity of surface runoff, promote infiltration, and reduce pollutant discharge by capturing and holding sediments and other pollutants in the runoff water. They may be natural, undeveloped land, or may be graded and planted with grass or other vegetation; and may be placed at many locations between the source of sediment (road surface, side slopes) and a natural or constructed waterway or other drainage area that could be impacted by deposits of sediment. Buffer strips may be used at any site that can support vegetation, but are best suited where soils are well drained and where the bedrock and water table are well below the surface. Buffer strips are particularly effective on flood plains, along stream banks, and at the top and bottom of a slope. Buffer strips may be either temporary or permanent.

**Common Failures** - *Generally due to faulty installation or maintenance.*

- Excessive sediment or oil and grease loads resulting in clogging.
- Introduction of storm water flows onto buffer strip before vegetation is established.

### **Other Considerations**

- Not effective for filtering high velocity flows from large, paved areas, steep slopes, or hilly areas.
- May be more viable than silt fence where silt fence installation and removal will cause more harm than good.
- Avoid flow concentration
- Buffer strips generally only trap coarse sediments. Depending upon vegetative type, clay and fine silt particles will generally pass through a buffer strip during periods of heavy rain.

- Preserve natural vegetation in clumps, blocks or strips where possible, particularly in areas adjacent to waterways.
  - Do not use planted or seeded ground as a buffer strip for sediment trapping until the vegetation is established.
- Extensive constructed buffers may increase development costs.

### **Relationship to Other ESC Measures**

Buffer strips are used in conjunction with diversion measures such as earth dikes, diversions, and slope drains for slope protection. Silt fences placed upslope may prevent sediment overloading.

### **Alternate Sediment Control Measures**

Diversion; Slope Drain

### **Other Names**

Buffer Zone, Vegetated Filter Strip.

### **Design**

**Location:** *Should be determined by considering slope, soil type, anticipated flow, and vegetation type.*

**Capacity:** *2 year peak runoff storm*

**Width:** *18 ft. - 60 ft., depending on type of vegetation and length of slope*

**Grading:** *smooth and uniform*

**Permitting:** *Wetland use as a vegetative buffer strip requires approval from the Corps of Engineers.*

**Flow Distribution:** *evenly distributed; avoid flow concentration*

### **Materials**

Natural vegetation, seed or sod; fertilizer, mulch, water; fencing or flagging

## **Installation**

### Natural Vegetation

Delineate undisturbed natural areas of vegetation that have been identified on the plans with flagging prior to the start of construction activities. Ensure that other sediment control measures to be used in conjunction with the buffer strip are in place and functioning properly. Minimize construction activities and traffic in the buffer strip and immediate surrounding areas.

### New Buffer Strip

Ensure that sediment control measures such as silt fence and diversions are in place to protect waterways or drainage areas until the buffer strip is established. Clear and grade the land according to the plans and specifications. Establish vegetation using specified seeding, mulching, watering, and fertilizer.

## **Inspection**

Inspect natural vegetation buffer strip areas at regular intervals to ensure that the fencing or flagging used to delineate non-disturbance areas are in place. Check for damage by equipment and vehicles. Inspect new buffer strip areas for the progress of germination and plant growth. Ensure that water flowing through the area is not forming ponds, rills, or gullies due to erosion within the buffer strip.

## **Maintenance**

Replace or repair fencing or flagging as necessary. Repair any damage by equipment or vehicles. Provide additional seed, fertilizer, and water to ensure adequate establishment of vegetation. Repair and reseed areas damaged by erosion or ponding of water.

## **Removal**

Temporary buffer strips - Provide and compact fill to existing or specified grade. Seed and mulch.

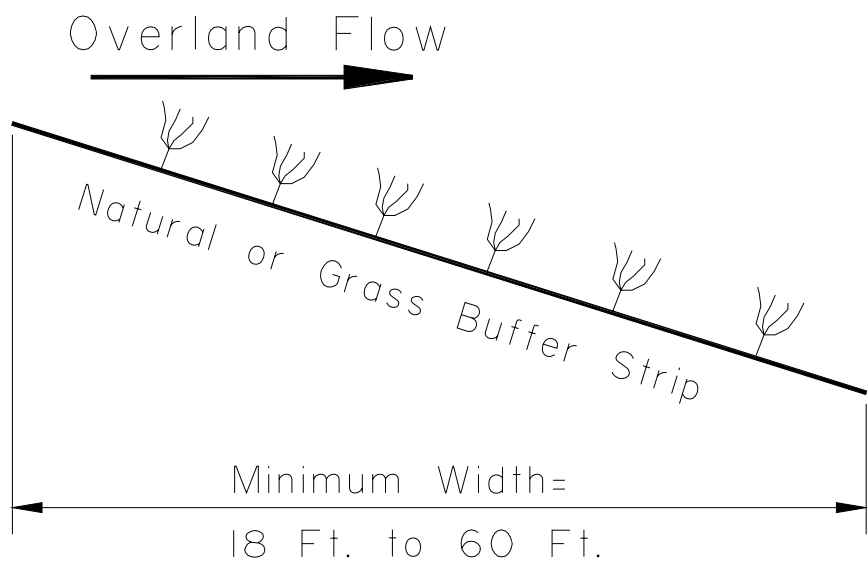

**VEGETATIVE BUFFER STRIP**

## Silt Fence

### Objectives and Applications

A silt fence is a perimeter control geotextile fence to prevent sediment in silt-laden sheet flow from entering sensitive receiving waters.

Silt fencing downslope from erosion-susceptible terrain traps sheet flow runoff before the drainage exits the project site. Intercepted drainage pools along the uphill side of the fence and standing water promote sediment settling out of suspension. Drainage in contact with the fence is filtered by the geotextile—the fabric’s small pores not only block eroded particles but also severely restrict water exfiltration rates.

Barrier locations are informally chosen based on site features and conditions (e.g. soil types, climate, terrain features, sensitive areas, etc.), design plans, existing and anticipated drainage courses, and other available erosion and sediment controls. Typical barrier sites are catchpoints beyond the toe of fill or on sideslopes above waterways or drainage channels. Silt fences are not recommended for wide low-flow, low-velocity drainageways, for concentrated flows, in continuous flow streams, for flow diversion, or as check dams. Use at drop or curb inlets is not appropriate for high volumes of stormwater.

**Common Failures** - Generally due to faulty installation or maintenance.

- Posts installed on uphill side of trench (instead of downhill side) or fabric attached to downhill side of posts (rather than uphill side).
- Slope erosion occurs below the fenceline due to drainage that bypasses the barrier end or water build-up that “blows out” a poorly secured fence bottom.
- Fence function impairment due to sediment build-up, maintenance neglect etc.
- Fence topples due to poor installation and/or high levels of impounded back-up water or sediment.
- Inappropriate for intended function (e.g. used for check dam, flow diversion, etc.).
- Uneven distribution of pooled drainage along non-level fenceline ground reduces efficiency.

- Poor support system (e.g. soil too rocky to secure posts, fabric stapled to trees, etc.).

### Other Considerations

*Use of sediment control measures and the level of effort should be commensurate to the potential problem. **Silt fence is not to be used solely as a project delineator.** (Use barriers, flagging, etc. instead.)*

- Use of a silt fence sediment control measure is usually more complex, expensive and maintenance-prone than other slope stabilization measures.
- Slope stabilization should occur at the earliest possible time.
- Fenceline proximity to sensitive areas needing protection during fence installation, maintenance, removal, etc. (e.g. avoid equipment encroachment on wetlands).
- Undesirable effects of fence placement (e.g. a trench in ground that won’t readily “heal” after fence removal; undesirable effects of water back-up, ditch overflow, etc.).
- Equipment access route/space required for fence installation, maintenance and removal.

### Relationship to Other ESC Measures

Sediment control measures are secondary to erosion prevention or soil stabilizing measures. Silt fences may be used as part of a sequential system with other temporary or permanent measures such as vegetation, check dams, settling ponds, etc. Occasional flow velocity increases may be offset using corrective measures such as rock berms or other redirecting energy absorbers.

### Alternate Sediment Control Measures

Brush bundles or straw bales to filter small amounts of sediment in shallow gullies or ditches. Temporary settlement basin. Gravel berm. Triangular sediment filter dike (stand-alone wire mesh structure covered with filter fabric on uphill side [labor intensive to construct and maintain]).

## Other Names

Geotextile for Sediment Control (sect 633 specifications) Filter Fence, Sediment Fence.

## Design

**Design life:** 1 season (6 months) or less

**Contributing sheet flow drainage area:** not to exceed 0.25 acres/ 100 ft. of fence

### Maximum Slope Length for Silt Fence

Slope (%)	18 in. Fence	30 in. Fence
2 (or less)	250 ft.	500 ft.
5	100 ft.	250 ft.
10	50 ft.	150 ft.
15	35 ft.	100 ft.
20	25 ft.	70 ft.
25	20 ft.	55 ft.
30	15 ft.	45 ft.
35	15 ft.	40 ft.
40	15 ft.	35 ft.
45	10 ft.	30 ft.

**Undisturbed buffer zone:** At least 3.5 ft. from fence to downstream sensitive area

**Support posts:** at least 18 in. in the ground. Minimum trench size (x-section): 6"x 6"

**Buried fabric:** 18 in. (3 sides of trench)

**Maximum spacing between posts:** 6 ft.

**Maximum fence height:** 3 ft. above ground

**Fabric joint overlap:** minimum 6 in. at post not allowed in pooled drainage areas

**Maximum height of ponding water:** 18 in.

**Maximum allowable depth of sediment accumulation against fence:** 9 in.

## Materials

Geotextile fabric sect 729-2.04 specification (AASHTO M 288 for Temporary Silt Fence except that minimum permittivity is .05/sec)

Support posts wood, steel or synthetic, adequate to support fence under field conditions

Staples or other means to attach fabric to posts

## Installation

Install fences after site clearing but before excavation/ fill work. Erect fenceline downslope along a level contour and perpendicular to anticipated sheet flow drainage path(s). Orient end sections uphill slightly and install sufficient length to keep drainage from spilling around barrier ends. Where ground surfaces are uneven, install shorter fences following contours (rather than install one long, contour-crossing fence that directs drainage to accumulate in low spots). Locate fence 3-10 ft. beyond toe of fill to leave room for a broad, shallow sedimentation pool and for equipment access during fence maintenance and removal. Leave buffers between fencing and sensitive receiving areas.

Drive support posts into the ground, excavate a trench on the uphill side along the line of the stakes, attach geotextile, and bury fence bottom. Soil backfill trench and compact to secure fence bottom. (Compacted soil is preferred to gravel fill. Using sandbags or cement blocks to anchor the fence bottom is undesirable because of the tendency for undermining). Keep fence fabric taut. Do not field-sew seams. Overlap joints at support posts but do not place overlapped joints across pooled drainage areas.

## Inspection

*A properly installed fence intercepts sheet drainage, contains sediments on site and does not permit spillover or bypass. Inspect as needed daily, weekly, or during/ following major rainfall events.*

Observe for fenceline continuity. Inspect fences for collapse, damage, undermine areas, compromised integrity, or other installation or functional inadequacies. Look for evidence of sediment or erosion flow leading off the downhill edge of the fence. (This may be an indicator of drainage bypass or fence undermine.) Note depth of sediment build up at the fence. Look for signs of inadequate protection of off-site sensitive areas. Observe turbidity levels of protected waterways and determine sources of sediment/siltation.

## **Maintenance**

Repair functional deficiencies immediately. Reinforce fenceline as needed to prevent undesirable sedimentation of sensitive areas. Replace torn or punctured fabric. Remedy fence sags as needed. Periodically remove accumulated sediment and dispose of silt waste in approved manner/location (typically in a non-erosion area).

## **Removal**

*Do not remove until the disturbed area is permanently stabilized or sediment protection is no longer needed.*

Unless directed otherwise, cut fabric at ground level, remove supports and spread sediment. Seed bare ground immediately. Discard filter fence as directed. Avoid damage to sensitive (e.g. wetland or surface water) areas. Stabilize areas.

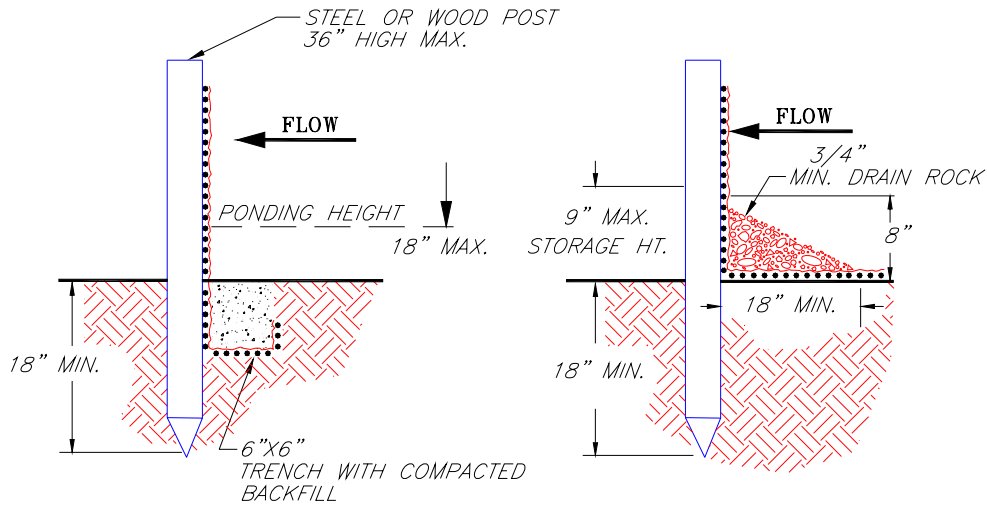
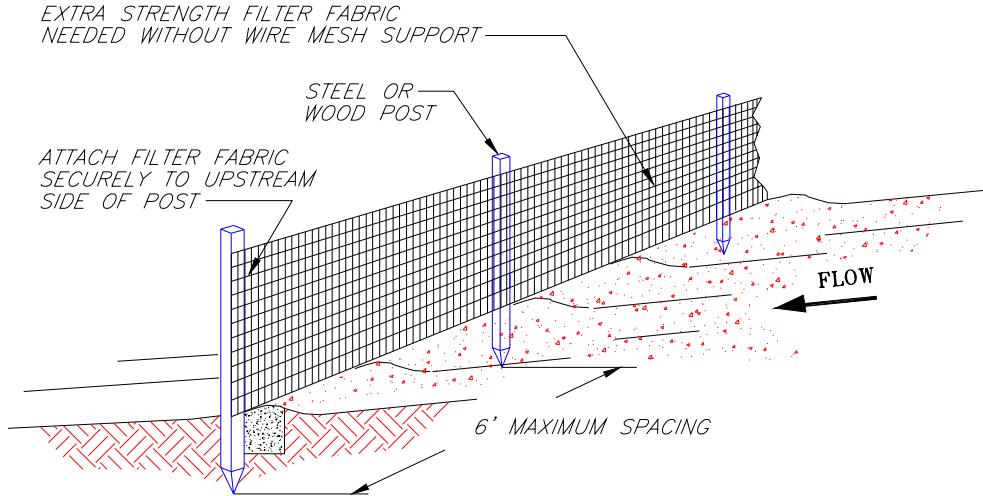

**TRENCH DETAIL**

**INSTALLATION WITHOUT TRENCHING**

- NOTES:
1. SILT FENCE FOLLOWS SLOPE CONTOURS TO MAXIMIZE PONDING EFFICIENCY.
  2. INSPECT AND REPAIR FENCE AFTER EACH STORM EVENT AND REMOVE SEDIMENT WHEN NECESSARY. 9" MAXIMUM SEDIMENT ACCUMULATION.
  3. REMOVED SEDIMENT SHALL BE DEPOSITED TO AN AREA THAT WILL NOT CONTRIBUTE SEDIMENT AND CAN BE PERMANENTLY STABILIZED.
- FILE: SILTFENC

NOT TO SCALE

© 1994 JOHN McCULLAH

## SILT FENCE



## **Inlet Protection**

### **Objectives and Applications**

Inlet protection is a temporary filtering measure placed around a drop inlet or curb inlet to trap sediment and prevent the sediment from entering the storm drain system.

This measure is employed where storm drain inlets are to be made operational before permanent stabilization of the disturbed area, where a permanent storm drain structure is being constructed on site and there is potential for sediment accumulating in an inlet, and where ponding of storm water around the inlet structure could be a problem to the traffic on site. There are several types of sediment filters applicable for different conditions; the three most commonly used are:

filter fabric fence – applicable to drop inlets with flows 0.5 cfs or less, and flat grades (5 % or less).

block and gravel filter – applicable to drop and curb inlets with flows 0.5 cfs or more, flat grades (5 % or less), where no construction traffic will cross over the inlet.

gravel and wire mesh filter – applicable to drop and curb inlets with flows 0.5cfs or more, flat grades (5 % or less), where construction traffic will cross over the inlet.

**Common Failures** - *Generally due to faulty installation or maintenance.*

- Sediment accumulation – filtering capacity is reduced, resulting in ponding of water
- Improper installation, resulting in sediment bypassing filter and entering storm drain
- Tearing, undermining, or collapsing of filter fabric, resulting in sediment entering storm drain

### **Other Considerations**

Inlet protection should be constructed in a manner that will facilitate cleanout and disposal of trapped sediment.

- Inlet protection should be constructed in a manner that will minimize ponding of storm water around the structure.
- Straw bale barriers should not be used for inlet protection.

### **Relationship to Other ESC Measures**

Inlet protection is installed as a secondary measure to remove residual sediment that was not removed by other measures, such as check dams, grassed swales, and sediment traps.

### **Alternate Sediment Control Measures**

Runoff from areas exceeding 1.0 acre or where grade is greater than 5% may require routing through a temporary sediment trap or sediment pond.

### **Other Names**

Storm Drain Inlet Protection, Filter Inlet

### **Design**

**Drainage Area:** *Not to exceed 1.0 acre*

**Slope Gradient:** *Not to exceed 5 %. For filter fabric fence designs, the area immediately surrounding the inlet should not exceed 1 %. Gravel filters may be more appropriate for steeper slopes.*

**Sediment Trapping Sump:** *Where possible, a sump 12 in. – 20 in. measured from the crest of the inlet should be excavated. Side slopes should be 2:1. The recommended volume of excavation is 35 cubic yards/acre of disturbed ground.*

**Orientation:** *The longest dimension of the basin should be oriented toward the longest inflow area.*

### **Materials**

Filter fabric fence – filter fabric (extra strength, filtering capacity 75 % minimum, meeting AASHTO Specification M 288 For Temporary Silt Fence); wooden stakes 2 in. x 4 in. – minimum length 3 ft.; heavy duty wire staples 1/2 in. long; washed gravel 3/4 in. – 1 ¼ in., with less than 5% fines.

Block and gravel filter – hardware cloth or wire mesh with 1/2 in. openings; filter fabric (optional) (AASHTO M 288); concrete blocks 4 in. – 12 in. wide, 12 in. – 24 in. high; washed gravel 3/4 in. – 4 in. in diameter; wood stud 2 in. x 4 in., for curb inlet applications.

Gravel and wire mesh filter - hardware cloth or wire mesh with 1/2 in. openings; filter fabric (AASHTO M 288); washed gravel 3/4 in. – 4 in. in diameter.

### **Installation**

Filter Fabric Fence – Place a stake at each corner of the inlet no more than 3 ft. apart. Drive stakes into the ground a minimum of 12 inches. For stability, install a frame of 2 in. x 4 in. wood strips around the top of the overflow area. Excavate a trench 8 in. wide x-12 in. deep around the outside perimeter of the stakes. If a sediment trapping sump is being provided, then the excavation may be as deep as 20 inches. Staple the filter fabric to the wooden stakes with heavy duty staples; ensure that 32 in. of filter fabric extends at the bottom so it can be formed into the trench. Place the bottom of the fabric into the trench - backfill with washed gravel all the way around.

Block and Gravel Filter – Secure the inlet grate to prevent seepage. Place wire mesh over the inlet so that it extends 12 in. - 20 in. beyond the inlet structure. Place filter fabric (optional) over the mesh and extend it 20 in. beyond the inlet structure. Place concrete blocks over the wire mesh or filter fabric in a single row lengthwise on their sides, with the open ends of the blocks facing outward, not upward; ensure that adjacent ends of blocks abut. For curb inlet applications, cut a 2 in. x 4 in. wood stud the length of the curb inlet plus the width of the two end blocks and place the stud through the outer hole of the end blocks to keep the blocks in place. Place wire mesh over the outside of the vertical face (open end) of the blocks to prevent gravel from being washed through the blocks. Place gravel against the wire mesh to the top of the blocks.

Gravel and Wire Mesh Filter – Secure the inlet grate. Place wire mesh over the inlet so that the mesh extends 12 in. beyond each side of the inlet structure. Place filter fabric over the mesh, extending it 20 in. beyond the inlet structure. Place washed gravel over the fabric/wire mesh to a depth of 12 inches.

### **Inspection**

Inspect inlet protection weekly and after every storm to look for sediment accumulation and structural damage.

### **Maintenance**

Remove sediment and restore structure to its original dimensions when sediment has accumulated to ½ the design depth. On gravel and mesh designs, clean (or remove and replace) the gravel filter or filter fabric if it becomes clogged. Repair any structural damage immediately.

### **Removal**

Remove the filter material and support structures after the drainage areas have been completely stabilized. Remove or stabilize trapped sediment. Stabilize disturbed soil areas resulting from removal.

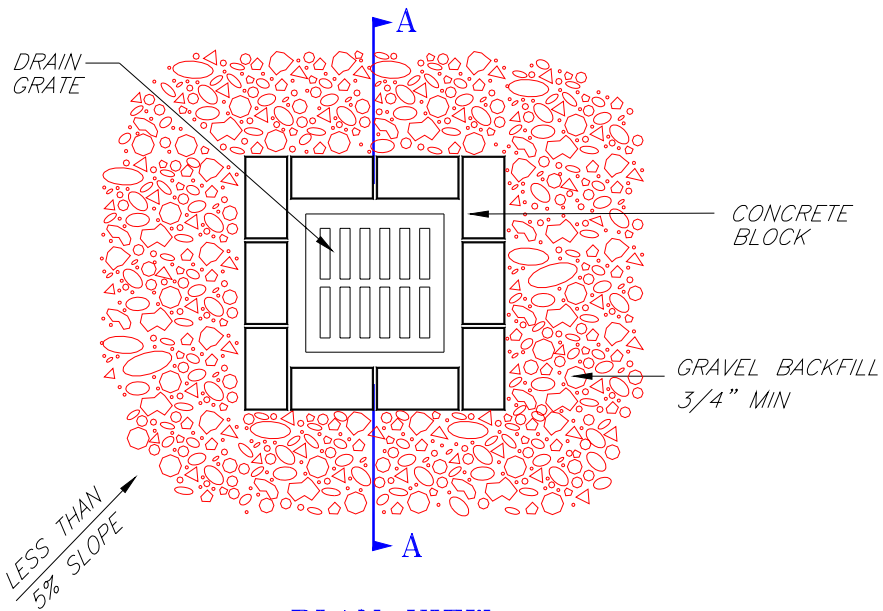

**PLAN VIEW**

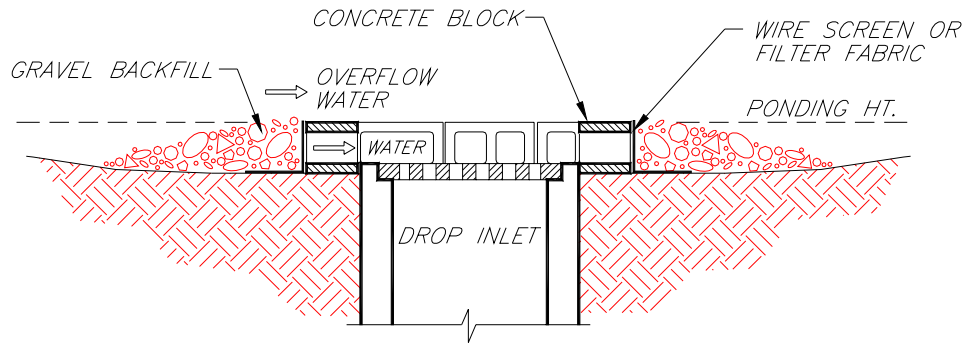

**SECTION A - A**

**NOTES:**

1. DROP INLET SEDIMENT BARRIERS ARE TO BE USED FOR SMALL, NEARLY LEVEL DRAINAGE AREAS. (LESS THAN 5%)
2. EXCAVATE A BASIN OF SUFFICIENT SIZE ADJACENT TO THE DROP INLET.
3. THE TOP OF THE STRUCTURE (PONDING HEIGHT) MUST BE WELL BELOW THE GROUND ELEVATION DOWNSLOPE TO PREVENT RUNOFF FROM BYPASSING THE INLET. A TEMPORARY DIKE MAY BE NECESSARY ON THE DOWNSLOPE SIDE OF THE STRUCTURE.

© 1994 JOHN McCULLAH

FILE: BGSEDBAR

**INLET PROTECTION**

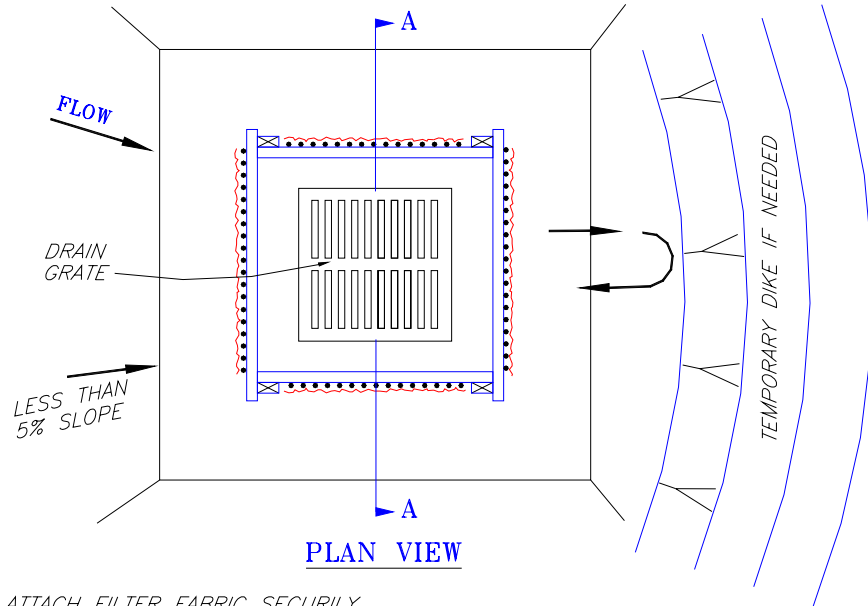

PLAN VIEW

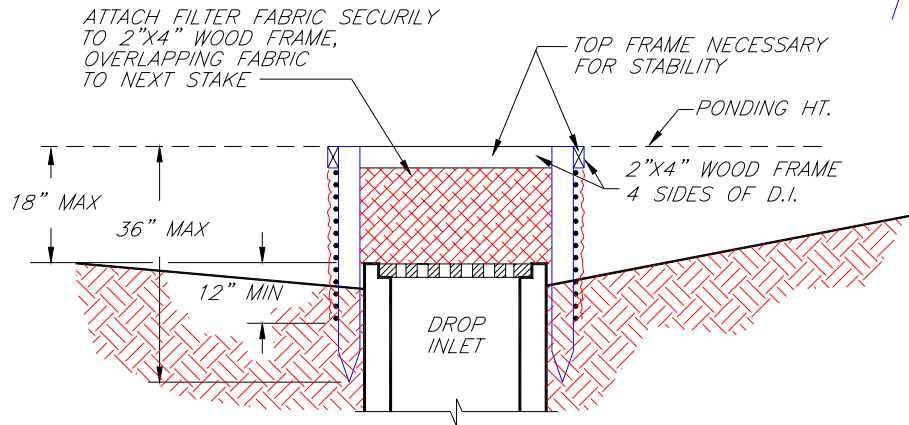

SECTION A-A

NOTES:

1. DROP INLET SEDIMENT BARRIERS ARE TO BE USED FOR SMALL, NEARLY LEVEL DRAINAGE AREAS. (LESS THAN 5%)
2. USE 2"x4" WOOD OR EQUIVALENT METAL STAKES, 3' MINIMUM LENGTH.
3. INSTALL 2"x4" WOOD TOP FRAME TO INSURE STABILITY.
4. THE TOP OF THE FRAME (PONDING HEIGHT) MUST BE WELL BELOW THE GROUND ELEVATION DOWNSLOPE TO PREVENT RUNOFF FROM BY-PASSING THE INLET. A TEMPORARY DIKE MAY BE NECESSARY ON THE DOWNSLOPE SIDE OF THE STRUCTURE.

NOT TO SCALE

© 1994 JOHN McCULLAHT

FILE: SILTFDIB

**INLET PROTECTION**

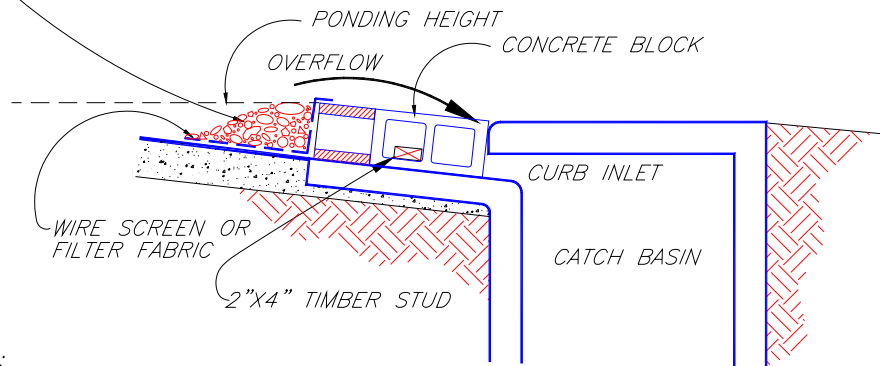
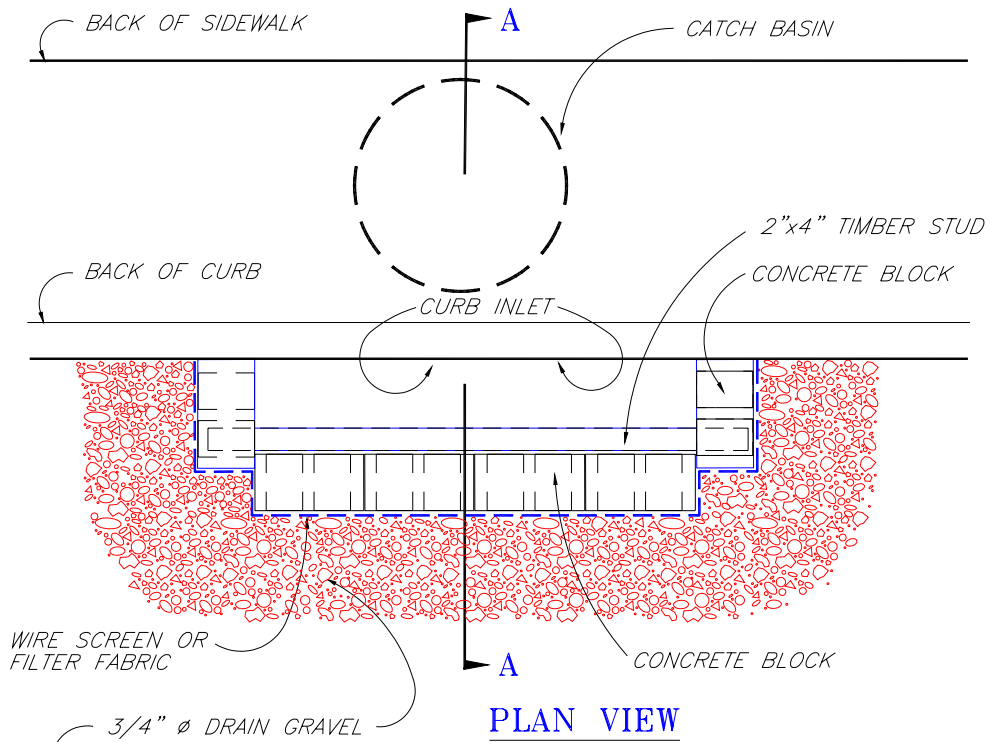

**NOTES:**

1. USE BLOCK AND GRAVEL TYPE SEDIMENT BARRIER WHEN CURB INLET IS LOCATED IN GENTLY SLOPING STREET SEGMENT, WHERE WATER CAN POND AND ALLOW SEDIMENT TO SEPARATE FROM RUNOFF.
2. BARRIER SHALL ALLOW FOR OVERFLOW FROM SEVERE STORM EVENT.
3. INSPECT BARRIERS AND REMOVE SEDIMENT AFTER EACH STORM EVENT. SEDIMENT AND GRAVEL MUST BE REMOVED FROM THE TRAVELED WAY IMMEDIATELY.

© 1994 JOHN McCULLAH

FILE: BLCKCURB

## INLET PROTECTION

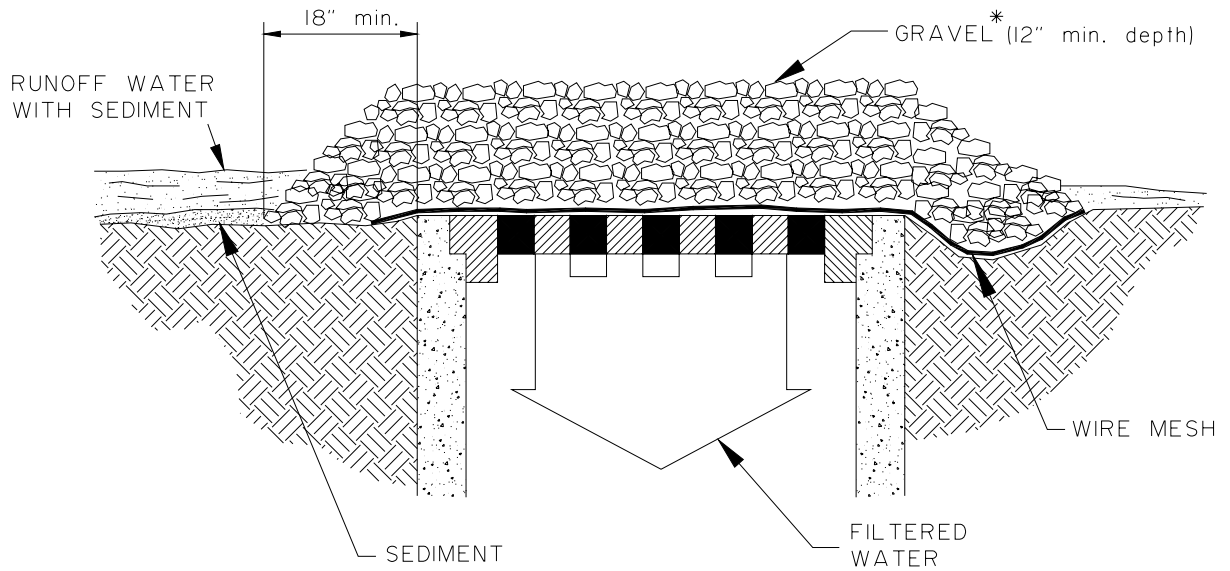

### SPECIFIC APPLICATION

THIS METHOD OF INLET PROTECTION IS APPLICABLE WHERE HEAVY CONCENTRATED FLOWS ARE EXPECTED, BUT NOT WHERE PONDING AROUND THE STRUCTURE MIGHT CAUSE EXCESSIVE INCONVENIENCE OR DAMAGE TO ADJACENT STRUCTURES AND UNPROTECTED AREAS.

## **INLET PROTECTION**

## **Straw Bale Barrier**

### **Objectives and Applications**

A straw bale barrier is a temporary sediment barrier consisting of a row of entrenched and anchored straw bales.

The purpose of a straw bale barrier is to intercept and retain sediment laden storm water runoff from disturbed areas of limited extent, preventing sediment from leaving the site; and to decrease the velocity of upslope sheet flows. The barrier is effective at the toe of embankment slopes, across minor swales and ditches, along property lines, and for other applications where the need for a barrier is temporary and structural strength is not required.

**Common Failures** - *Generally due to faulty installation or maintenance.*

- Lateral flanking of bales due to insufficient height or width, or due to ends of bales not flared upslope.
- Improper placement and installation, such as staking the bales directly onto the ground with no soil seal or entrenchment, allowing undercutting or end flow.
- Excessive gaps between bales are present, allowing water and sediment to escape.
- Sediment accumulation, resulting in loss of filtering capacity.

### **Other Considerations**

- Straw bale barriers should not be constructed in streams or in swales where there is the possibility of a washout.
- Straw bale barriers should not be used on areas where rock or other hard surfaces prevents the uniform anchoring of the barrier.
- Straw bale barriers should not be constructed where flows are likely to exceed 0.3 cubic ft./second.
- Straw bale barriers should not be used where the control of sediment is critical, in high risk areas, or where ponded water could flow onto the roadway.
- Proper installation and maintenance are critical to the function of straw bale barriers.

### **Relationship to Other ESC Measures**

Straw bale barriers may be used as silt traps and check dams. They function to reduce flow velocities and cause sediment deposition. They may also be used as a barrier to divert or direct runoff to a slope drain, sediment trap, or other control measure.

### **Alternate Sediment Control Measures**

Silt Fence, Brush Barrier

### **Other Names**

Erosion Bale, Straw Bale Dike, Straw Bale Sediment Trap

### **Design**

**Design life:** *3 months or less*

**Contributing flow drainage area:** *not to exceed 0.25 acres per 100 ft. of bales*

**Maximum slope steepness:** *2:1*

**Maximum flow path length to barrier:** *150 ft.*

### **Materials**

Straw bales (wire bound or string tied), wood or metal stakes.

### **Installation**

Excavate a trench the width of the bale and the length of the proposed barrier to a minimum depth of 4 in. Place the bales in a single row, lengthwise on the contour, with ends of the adjacent bales tightly abutting one another. If the barrier is located at the toe of a slope, place it 5 – 6 ft. away from the slope if possible. Ensure that all bales are wire-bound or string tied. Install bales so that bindings are oriented around the sides rather than along the tops and the bottoms of the bales in order to prevent deterioration of the bindings. Place and anchor each bale with at least two wood stakes, minimum dimensions, 2 in. x 2 in. x 36 in., or with # 4 reinforcing bars, driving the first stake toward the previously placed bale to force the bales together. Drive the stakes or reinforcing bars a minimum of 12 in. into the ground. Fill any gaps between bales with tightly wedged straw. Backfill with excavated soil to ground level on the downhill side and up to 4 in. against the uphill side of the barrier.

**Inspection**

Inspect barrier weekly and immediately after each rainfall to look for sediment accumulation, damaged bales, end runs, and undercutting beneath bales.

**Maintenance**

Remove sediment deposits when they reach approximately one-half the height of the uphill edge of the barrier. Repair or replace damaged bales promptly.

**Removal**

Straw bale barriers and accumulated sediment may be spread and seeded; or may be removed after they have served their usefulness, but not before the upslope areas have been permanently stabilized with vegetation.



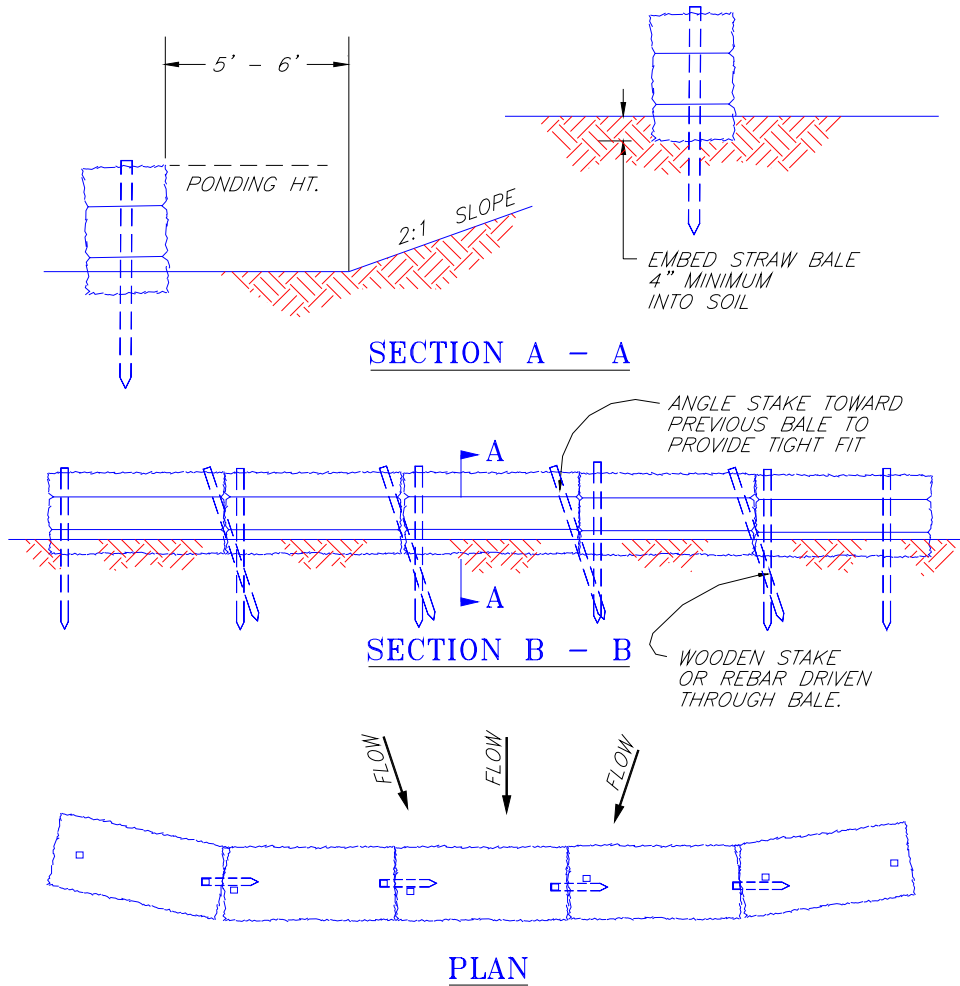

**NOTES:**

1. THE STRAW BALES SHALL BE PLACED ON SLOPE CONTOUR.
2. BALES TO BE PLACED IN A ROW WITH THE ENDS TIGHTLY ABUTTING.
3. KEY IN BALES TO PREVENT EROSION OR FLOW UNDER BALES.

© 1994 JOHN McCULLAH  
FILE: STRWDIKE

**STRAW BALE BARRIER**

## **Brush Barrier**

### **Objectives and Applications**

A brush barrier is a temporary sediment barrier constructed at the perimeter of a disturbed site from the residual materials available from clearing and grubbing the site.

The purpose of a brush barrier is to intercept and retain sediment laden storm water runoff from disturbed areas of limited extent, preventing sediment from leaving the site. The barrier is constructed of tree limbs, weeds, vines, root mat, soil, rock, or other cleared materials piled together to form a berm, and located across or at the toe of a slope susceptible to sheet and rill erosion.

**Common Failures** - *Generally due to faulty installation or maintenance.*

- Materials that are too large are used, creating voids where sediment can easily pass through.
- Barrier constructed too loosely, allowing water and sediment to easily pass through.
- Sediment accumulation, resulting in loss of filtering capacity.

### **Other Considerations**

- Enough residual material should be available on site for barrier construction.
- Material larger than 6 in.ches in diameter should not be used since it tends to create large voids.
- Barrier should be used only in areas of sheet or very low flow.
- Barrier should not be constructed where the maximum upslope gradient exceeds 2:1.
- Brush barriers should act as a filter, not a dam. If it is impermeable, then water will flow around it and outlet treatment will be required.

### **Relationship to Other ESC Measures**

Brush barriers are utilized to retain sediment that would otherwise be deposited in other downslope sediment control measures, such as sediment traps and sediment ponds.

### **Alternate Sediment Control Measures**

Straw Bale Barrier; Silt Fence

### **Other Names**

Brush Berm, Brush Bundle

### **Design**

**Design life:** *1 season (6 months) or less*

**Contributing flow drainage area:** *not to exceed 0.25 acres*

**Height:** *3 ft. minimum to 5 ft. maximum*

**Width: (at base) 5 ft.) minimum to 15 ft. maximum**

### **Materials**

Residual on site materials from clearing and grubbing activities – brush, tree limbs, root mat, weeds, vines, rock, or other cleared materials; nylon or polypropylene rope, rebar stakes; geotextile fabric (optional) meeting AASHTO specification M 288 for temporary silt fence.

### **Installation**

Construct the barrier to the specified height and width by piling brush, stone, root mat and other material from the clearing and grubbing process into a mounded row on the contour. Ensure that barrier structure is uniform and that no significant voids are present. Cover with geotextile fabric (optional). Anchor into the ground using 1/4 in. polypropylene or nylon rope tied across the berm in a crisscross fashion and secured to 18 in. long x 3/8 in. diameter rebar stakes.

### **Inspection**

Inspect barrier weekly and after heavy rains to look for sediment accumulation

### **Maintenance**

Sediment deposits should be removed when they reach approximately one-third the height of the uphill edge of the barrier.

### **Removal**

Brush barriers should be removed after they have served their usefulness, but not before the upslope areas have been permanently stabilized. Remove and stabilize trapped sediment. Stabilize disturbed soil areas resulting from removal. Brush barriers should only be left in-place if specifically allowed in the contract documents.

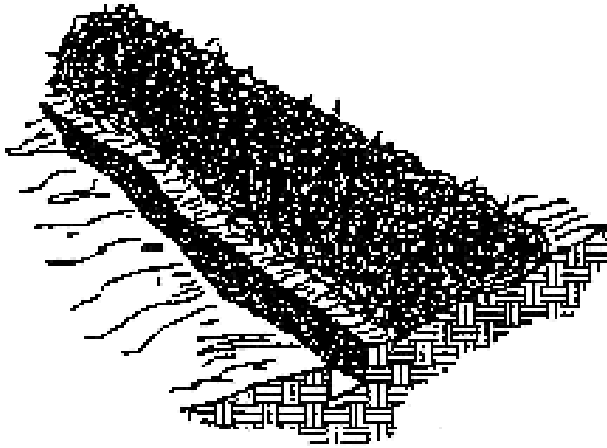

Excavate a 4" X 4" trench along the uphill edge of the Brush Barrier.

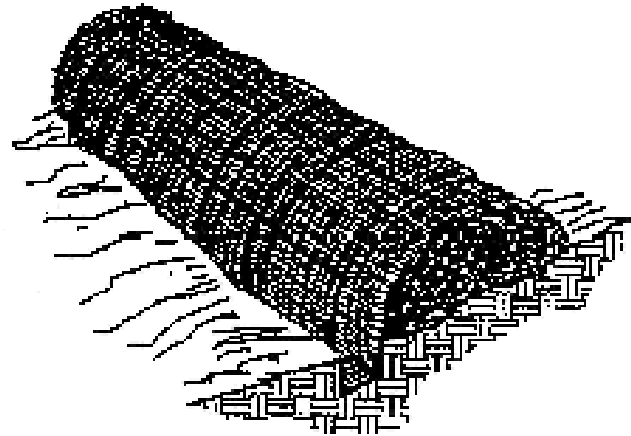

Drape a geotextile over the barrier and into the trench. The geotextile should be secured in the trench with stakes set approximately 36" on center.

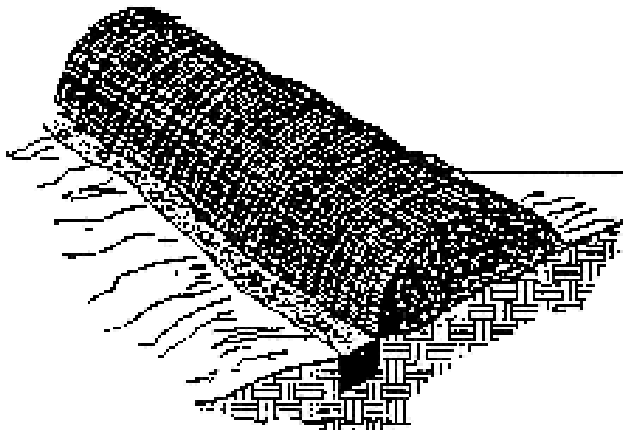

Backfill and compact the excavated soil.

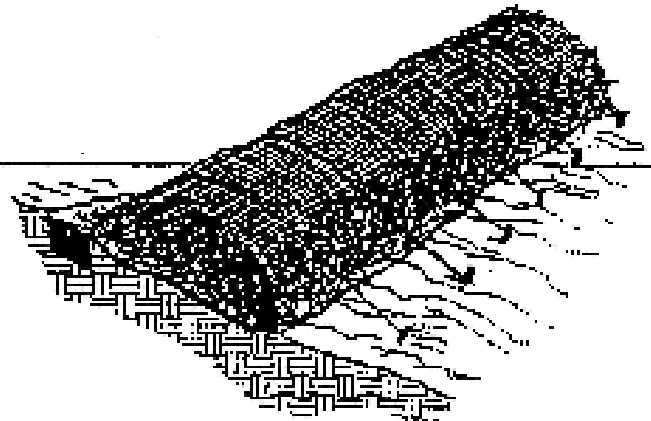

Set stakes along the downhill edge of the barrier, and anchor by tying twine from the geotextile to the stakes.

## BRUSH BARRIER

## **Vehicle Tracking Entrance/Exit**

### **Objectives and Applications**

A vehicle tracking entrance/exit provides a stabilized gravel area or pad underlined with a geotextile and located where traffic enters or exits the construction site.

This measure establishes a buffer area for vehicles to deposit their mud and sediment, and minimize the amounts transported onto public roadways. Mud on a road can create a safety hazard as well as a sediment problem. This measure may be used with or without washdown, depending upon severity of problem.

**Common Failures** - *Generally due to faulty installation or maintenance.*

- Inadequate depth and length of gravel.
- Failure to periodically “top dress” (provide additional gravel) when sediment accumulates on the surface.
- Failure to repair and/or clean out any structures used to trap sediment.

### **Other Considerations**

- Avoid entrances/exits which have steep grades or which are located where sight distance may be a problem.
- Provide drainage to carry water to sediment trap or other suitable outlet.

### **Design**

**Gravel Size:** *2 in.-3 in.*

**Pad Thickness:** *minimum 6 in.*

**Pad Width:** *minimum 12 ft.*

**Pad Length:** *minimum 50 ft.*

### **Materials**

Gravel, geotextile

### **Installation**

Clear the entrance and exit area of all vegetation, roots, and other material and properly grade it. Place geotextile prior to placement of gravel. Place the gravel to the specific grade shown on the plans, and smooth it. Provide drainage to carry water to a sediment trap or other outlet.

### **Inspection**

Inspect pads and sediment trapping structures daily for sediment accumulation and material displacement.

### **Maintenance**

Maintain each entrance in a condition that will prevent tracking of mud or sediment onto public rights-of-way. Replace gravel material when surface voids are visible. Top dress with 2 in. gravel when pad becomes laden with sediment. Repair and/or clean out any structures used to trap sediment. Remove all mud and sediment deposited on paved roadways within 24 hours.

### **Removal**

Remove pad and any sediment trapping structures after they are no longer needed, or within 30 days after final site stabilization. Remove and stabilize trapped sediment on site.

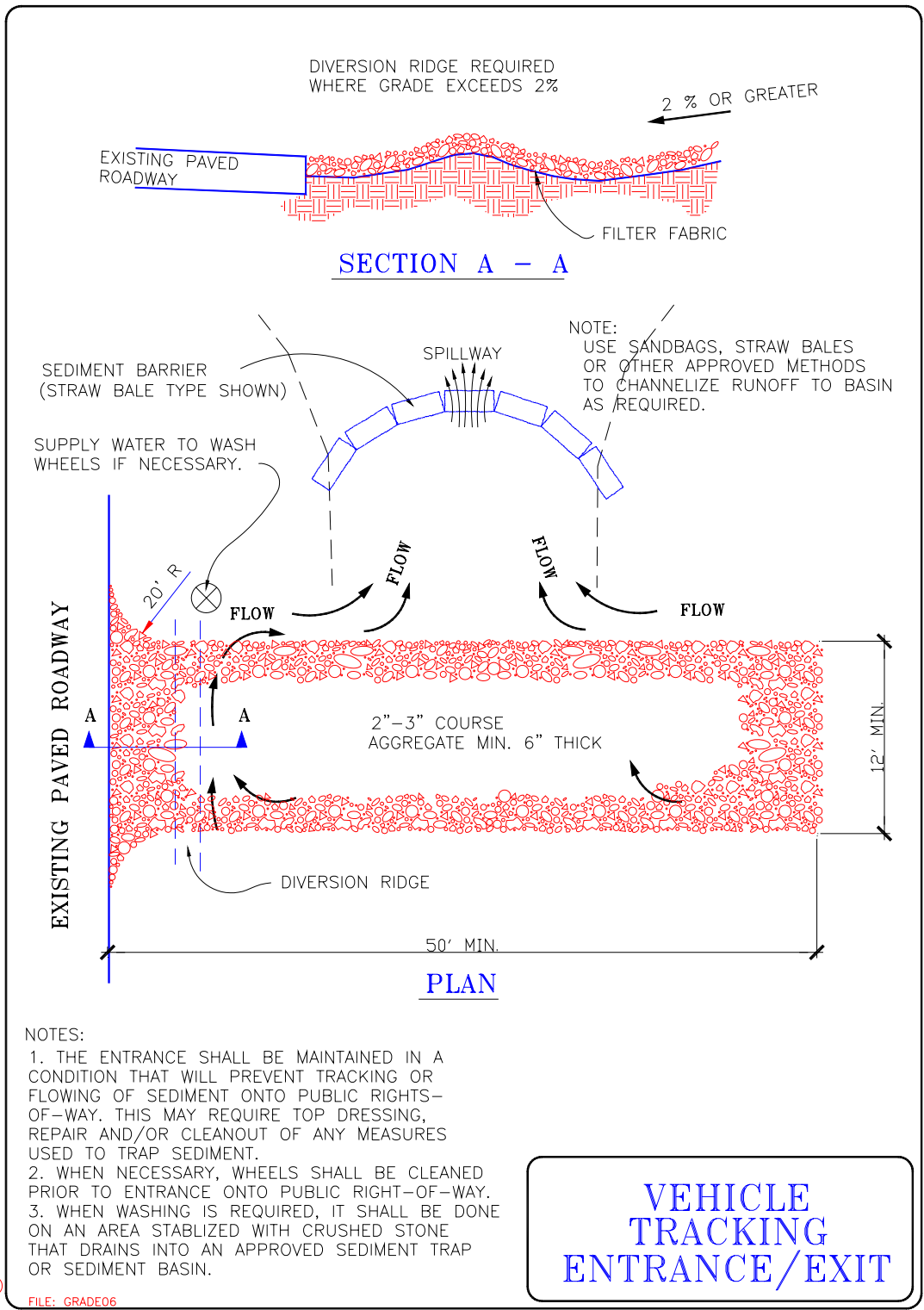

© 1994 JOHN McCULLAH

**Vehicle Tracking Entrance/Exit**

# Appendix B

## Seed Selection Tables

## Instructions for Species and Mix Selection Chart

1. Select region of state based on map (Fig. 16-B-1). Do not be overly concerned about where the site is in relation to boundaries. At that point, it is a judgment call.
2. Select the best guess for the soil moisture conditions over the site.
3. Select the soil based on the Unified Classification System. Coarse-grained soils are denoted by (G) gravel and (S) sand. Five gravel soils are denoted by (C) and (M) clays and silts, (O) organic, and (Pt) Peat or Muck. Suffixes used are (W) well graded, (P) poorly graded, (L) Low plasticity, (H) high plasticity.
4. Select at least two entries labeled "1". These should account for between 80% and 100% of the seed mix. If the project tends to be uniform with regard to soil conditions, a two to three species mix can suffice. When uniform conditions exist, a mix of "category 1" species can suffice and the mix will be 100% "category 1" species. Conversely, if there is a broad range of soil conditions, "category 1" species should comprise the lower end of the percent range. All entries are listed in order of preference. For example, a project in the southcentral region with average soil moisture and SW soils Norcoast Bering Hairgrass should be at least 60% of the "category 1" portion of the mix. The other category 1 species could be selected in order to form 100% of the mix or a portion equaling 80%. If the lower range is selected, category 2 species and possibly category 3 would be used to form a complete mix. Wainwright Slender Wheatgrass would be the perfect category 2 species followed by Boreal Red Fescue. The preference listing allows the designer to select species based on local preference, availability and cost (cost being the least important). "Category 2" species are used to give variability to the mix allowing the designer to cover a broad range of conditions. "Category 3" on the other hand, usually includes species in short supply or of high cost. The category 3 material adds a high degree of variability to the mix. Category 3 species may also be recommended when special concerns about environmental issues such as stream crossings are encountered. It is strongly suggested that at least one selection be made from the entries labeled "2". This portion will supplement the "1"s so that the total mix equals 100%. If the engineer or designer really wants to add more species, select any category "3" species or cultivar. The category 3 should not exceed 5% of the total mix. It should also come from the category 1 percentages.
5. Seeding rates for the entire mix are listed in the column "Seeding Rate". This number represents either pounds per acre or kilograms per hectare. They are close enough to be of little consequence. Annual ryegrass provides a quick growing component to the seed mix. The resulting grass cover will prevent erosion until the perennial grasses emerge. Annual ryegrass also gives the appearance of a complete job (the seeding contractor can be paid).
6. If the site is determined to be an erosion hazard add 10% annual rye grass to the previously developed mix. For example, a 30 lb./acre seed mix will have 3 lb. of annual ryegrass added. Annual rye tends to use the fertilizer intended for the perennial grasses. The species, while giving temporary erosion protection, does, to some extent compete with the long-term perennial species. Also annual ryegrass is a highly palatable and attractive forage species that can attract herbivores (i.e., moose and deer)

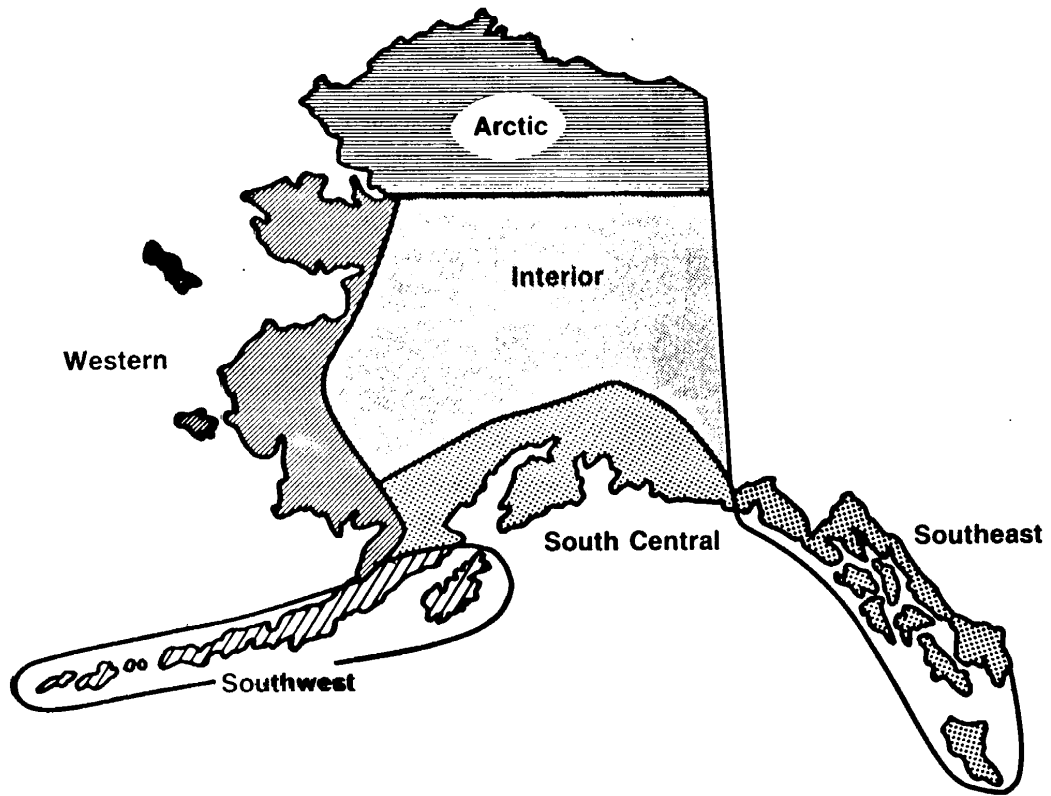

Modified from Wright 1988

Figure 16-B-1  
Alaska Vegetation Regions



## SEEDING SCHEDULE FOR ARCTIC ALASKA

Soil Moisture	Soil Group	Species/Cultivar Selections		Seeding Rate lb./ac.
Very Wet (Hydric)	GM, GC	1 Arctared Red Fescue 1 Alyeska Polargrass 2 Tundra Glaucous Bluegrass 2 Norcoast Bering Hairgrass Slougrass	3 Egan American 3 Boreal Red Fescue	30
	SW, SP, SM, SC	1 Arctared Red Fescue 1 Alyeska Polargrass 1 Tundra Glaucous Bluegrass 2 Gruening Alpine Bluegrass	2 Nortran Tufted Hairgrass 3 Norcoast Bering Hairgrass 3 Caiggluk Tilesy Sagebrush	40
	ML, CL, OL, MH, CH, OH	1 Arctared Red Fescue 1 Alyeska Polargrass 2 Tundra Glaucous Bluegrass	2 Norcoast Bering Hairgrass 3 Egan American Sloughgrass	30
Average (Mesic)	GM, GC	1 Arctared Red Fescue 1 Alyeska Polargrass 1 Tundra Glaucous Bluegrass	2 Nortran Tufted Hairgrass 2 Gruening Alpine Bluegrass	30
	SW, SP, SM, SC, ML, CL, OL	1 Arctared Red Fescue 1 Alyeska Polargrass 1 Tundra Glaucous Bluegrass 2 Gruening Alpine Bluegrass	2 Nortran Tufted Hairgrass 3 Norcoast Bering Hairgrass 3 Caiggluk Tilesy Sagebrush	40
	MH, CH, OH	1 Arctared Red Fescue 1 Alyeska Polargrass 2 Tundra Glaucous Bluegrass	2 Norcoast Bering Hairgrass 3 Egan American Sloughgrass	30
Very Dry (Xeric)	GM, GC	1 Arctared Red Fescue 1 Alyeska Polargrass	1 Tundra Glaucous Bluegrass 2 Gruening Alpine Bluegrass	30
	SW, SP, SM, SC, ML, CL, OL	SAME AS MESIC		40
	MH, CH, OH	SAME AS MESIC		30
<p>Notes: 1. PT soils are not highly erodible. Recommend no seeding, only fertilizer application. If seeding is recommended use either Mesic or Xeric schedule.</p> <p>2. GW and GP soils are not highly erodible. Recommend fertilizer and scarification only. If seeding is recommended use GM, GC schedule for appropriate moisture.</p>				

### SEEDING SCHEDULE FOR WESTERN ALASKA

Soil Moisture	Soil Group	Species/Cultivar Selections		Seeding Rate lb./ac.
Very Wet (Hydric)	GM, GC	1 Norcoast Bering Hairgrass 1 Arctared Red Fescue 1 Egan American Slougrass 2 Nortran Tufted Hairgrass	2 Boreal Red Fescue 2 Alyeska Polargrass 2 Caiggluk Tilesy Sagebrush	30
	SW, SP, SM, SC	1 Arctared Red Fescue 1 Norcoast Bering Hairgrass 1 Nortran Tufted Hairgrass 1 Gruening Alpine Bluegrass	2 Alyeska Polargrass 2 Kenai Polargrass 2 Tundra Glaucous Bluegrass 3 Sourdough Bluejoint Grass	40
	ML, CL, OL, MH, CH, OH	1 Norcoast Bering Hairgrass 1 Egan American Sloughgrass 1 Arctared Red Fescue	2 Alyeska Polargrass 2 Boreal Red Fescue 3 Caiggluk Tilesy Sagebrush	30
Average (Mesic)	GM, GC	1 Arctared Red Fescue 1 Norcoast Bering Hairgrass 1 Tundra Glaucous Bluegrass 2 Boreal Red Fescue	2 Alyeska Polargrass 2 Nortran Tufted Hairgrass 2 Gruening Alpine Bluegrass 3 Caiggluk Tilesy Sagebrush	30
	SW, SP, SM, SC, ML, CL, OL, MH, CH, OH	1 Arctared Red Fescue 1 Norcoast Bering Hairgrass 1 Nortran Tufted Hairgrass 1 Gruening Alpine Bluegrass	2 Alyeska Polargrass 2 Kenai Polargrass 2 Tundra Glaucous Bluegrass 3 Sourdough Bluejoint Grass	40
Very Dry (Xeric)	GM, GC	1 Arctared Red Fescue 1 Norcoast Bering Hairgrass 1 Gruening Alpine Bluegrass 2 Nortran Tufted Hairgrass	2 Tundra Glaucous Bluegrass 2 Boreal Red Fescue 3 Sourdough Bluejoint Grass	30
	SW, SP, SM, SC, ML, CL, OL, MH, CH, OH	SAME AS AVERAGE (MESIC) FOR SOIL GROUP		40
<p>Notes: 1. PT soils are not highly erodible. Recommend no seeding, only fertilizer application. If seeding is recommended use either Hydric schedule for MH, CH, OH.</p> <p>2. GW and GP soils are not highly erodible. Recommend fertilizer and scarification only. If seeding is recommended use SW, SP, SM, SC schedule for appropriate moisture.</p> <p>3. If the area to be revegetated is adjacent to a coastline, consider using Beach Wildrye transplants.</p>				

## SEEDING SCHEDULE FOR INTERIOR ALASKA

Soil Moisture	Soil Group	Species/Cultivar Selections		Seeding Rate lb./ac.
Very Wet (Hydric)	GM, GC SW, SP, SM, SC, ML, CL, OL	1 Norcoast Bering Hairgrass 1 Arctared Red Fescue 1 Egan American Slougrass 2 Nortran Tufted Hairgrass	2 Boreal Red Fescue 2 Alyeska Polargrass 2 Caiggluk Tilesy Sagebrush 3 Sourdough Bluejoint Grass	30
	MH, CH, OH	1 Arctared Red Fescue 1 Norcoast Bering Hairgrass 1 Nortran Tufted Hairgrass 1 Gruening Alpine Bluegrass	2 Alyeska Polargrass 2 Kenai Polargrass 2 Tundra Glaucous Bluegrass 3 Sourdough Bluejoint Grass	30
Average (Mesic)	GM, GC	1 Arctared Red Fescue 1 Wainwright Slender Wheatgrass 1 Norcoast Bering Hairgrass	2 Nortran Tufted Hairgrass 2 Boreal Red Fescue 3 Tundra Glaucous Bluegrass 3 Caiggluk Tilesy Sagebrush	
	SW, SP, SM, SC, ML, CL, OL, MH, CH, OH	1 Arctared Red Fescue 1 Wainwright Slender Wheatgrass 1 Norcoast Bering Hairgrass 1 Gruening Alpine Bluegrass 2 Boreal Red Fescue	2 Alyeska Polargrass 2 Nortran Tufted Hairgrass 2 Tundra Glaucous Bluegrass 3 Caiggluk Tilesy Sagebrush	40
Very Dry (Xeric)	GM, GC	1 Arctared Red Fescue 1 Norcoast Bering Hairgrass 1 Gruening Alpine Bluegrass 2 Nortran Tufted Hairgrass	2 Tundra Glaucous Bluegrass 2 Boreal Red Fescue 3 Sourdough Bluejoint Grass	30
	SW, SP, SM, SC, ML, CL, OL, MH, CH, OH	SAME AS AVERAGE (MESIC) FOR SOIL GROUP		40
<p>Notes: 1. PT Soils are not highly erodible. Recommend no seeding, only fertilizer application. If seeding is recommended use MH, CH, OH Mesic or Xeric depending on site.</p> <p>2. GW, GP soils are not highly erodible. Recommend scarification and fertilization only. If seeding is recommended use GM, GC specifications.</p>				

### SEEDING SCHEDULE FOR SOUTHCENTRAL ALASKA

Soil Moisture	Soil Group	Species/Cultivar Selection		Seeding Rate lb./ac.
Very Wet (Hydric)	GM, GC, SW, SP, SM, SC, ML, CL, OL	1 Norcoast Bering Hairgrass 1 Egan American Sloughgrass 1 Kenai Polargrass 2 Nortran Tufted Hairgrass 2 Boreal Red Fescue 2 Alyeska Polargrass	3 Sourdough Bluejoint Grass	20 GM, GC  40 Others
	MH, CH, OH	1 Norcoast Bering Hairgrass 1 Arctared Red Fescue 1 Egan American Sloughgrass	2 Alyeska Polargrass 2 Gruening Alpine Bluegrass	30
Average (Mesic)	All	1 Norcoast Bering Hairgrass 1 Arctared Red Fescue 1 Gruening Alpine Bluegrass 2 Wainwright Slender Wheatgrass 2 Boreal Red Fescue	2 Kenai Polargrass 2 Nortran Tufted Hairgrass 3 Caiggluk Tilesy Sagebrush 3 Sourdough Bluejoint Grass	40
Very Dry (Xeric)	All	1 Arctared Red Fescue 1 Wainwright Slender Wheatgrass 1 Nortran Tufted Hairgrass	1 Gruening Alpine Bluegrass 2 Norcoast Bering Hairgrass 2 Boreal Red Fescue	30
Notes: 1. PT soils are not highly erodible. Recommend no seeding, only fertilizer application. If seeding is recommended use either Mesic or Xeric schedule. 2. GW and GP soils are not highly erodible. Recommend fertilizer and scarification only. If seeding is recommended use GM, GC schedule for appropriate moisture.				

### SEEDING SCHEDULE FOR SOUTHWESTERN ALASKA

Soil Moisture	Soil Group	Species/Cultivar Selections		Seeding Rate lb./ac.
All	All	1 Norcoast Bering Hairgrass 1 Boreal Red Fescue 2 Arctared Red Fescue 2 Nortran Tufted Hairgrass 2 Caiggluk Tilesy Sagebrush 3 Sourdough Bluejoint Grass 3 Pennlawn Red Fescue		40
Notes: 1. PT soils are not highly erodible. Recommend no seeding, only fertilizer application. If seeding is recommended, use standard southwest schedule. 2. GW and GP soils are not highly erodible. Recommend fertilizer and scarification only. If seeding is recommended, use southwest schedule. 3. If the area to be revegetated is adjacent to a coastline, consider using Beach Wildrye transplants.				

### SEEDING SCHEDULE FOR SOUTHEAST ALASKA

Soil Moisture	Soil Group	Species/Cultivar Selections	Seeding Rate lb./ac.
All	All	1 Norcoast Bering Hairgrass 1 Boreal Red Fescue 2 Arctared Red Fescue 2 Nortran Tufted Hairgrass 2 Caiggluk Tilesy Sagebrush 3 Gruening Alpine Bluegrass 3 Sourdough Bluejoint Grass	30
Notes: <ol style="list-style-type: none"> <li>1. Pt soils are not highly erodible. Recommend no seeding, only fertilizer application. If seeding is recommended, use standard southwest schedule.</li> <li>2. GW and GP soils are not highly erodible. Recommend fertilizer and scarification only. If seeding is recommended, use southwest schedule.</li> <li>3. If the area to be revegetated is adjacent to a coastline, consider using Beach Wildrye transplants.</li> </ol>			

# **Appendix C**

## **Soil Erodibility**

## Soil Erodibility Chart

CLASSIFICATION		ERODIBILITY <sup>1,2</sup>				
GEOLOGIC DESCRIPTION	USCS CLASSIFICATION <sup>3</sup>	GENERAL	SLOPE ANGLE < 45 degrees	SLOPE ANGLE > 45 degrees	SLOPE LENGTH < 30 feet	SLOPE LENGTH > 30 feet
<b>ALLUVIAL</b>						
High Energy	GW, GP, GM	Low	Low-Med	Med	Low-Med	Med
Low Energy		Med-High	Med-High	High	Med-High	High
<b>COLLUVIAL<sup>4</sup> (Slope wash)</b>	Various	Low - High	Low - High	Low - High	Low - High	Low - High
<b>EOLIAN (wind deposited)</b>						
Dune Sand	SP	High	High	Very High	High	Very High
Loess	ML, SM	High-Very High	High-Very High	Very High	High-Very High	Very High
<b>GLACIAL<sup>5</sup></b>						
Till	GM, SM, ML	Low-Med	Low-Med	Low-Med	Low-Med	Med
Outwash	GW, GP, GM, SW, SP, SM	Low-Med	Low-Med	Med	Low-Med	Med
Glaciolacustrine	ML, SM, SP	Med-High	Med	High	Med	High
<b>LACUSTRIN (Lake deposits)</b>	ML, SM, MH, OL, CL, CH, OH, PT	High	High	High-Very High	High	High-Very High
<b>MARINE</b>						
High Energy	GW, GP, SW, SP	Med	Med	Med-High	Med	Med-High
Low Energy	SM, ML, MH, CL, CH, OL, OH	High	High	High-Very High	High	High-Very High
<b>RESIDUAL - SEDENTARY<sup>6</sup></b>	Various	Low - High	Low - High	Low - High	Low - High	Low - High

### Notes

- <sup>1</sup> Erodibility is the relative, qualitative erosion potential of a particular soil type as related to the indicated slope geometry. "Low" erodibility means little or no significant erosion is likely to occur during construction and the life of the project. "Medium" erodibility means that significant erosion is likely to occur during construction and the life of the project. "High" erodibility means significant erosion will occur during construction and during the life of the project, even with intensive soil conservation methods. Water conditions are assumed to be "worst case," with significant sheet flow and underground water daylighting on the slope. Climate, rainfall, and vegetative cover factors also dictate erodibility but are not addressed here.
- <sup>2</sup> Select appropriate BMP after reference to guidelines in this chapter, Geotechnical Recommendations and Reports, DOT&PF "Standard Specifications for Highway Construction," DOT&PF Regional Best Management Practices, AASHTO "Guidelines for Erosion and Sediment Control in Highway Construction, Volume III," and other references.
- <sup>3</sup> Unified Soil Classification System - ASTM D-2487
- <sup>4</sup> Mass of loose soil and/or rock fragments that has moved downslope - classification and erosion characteristics vary, depending on parent material, which can include any soil component from clay to boulders and organics.
- <sup>5</sup> Till soils are directly deposited by glaciers and may contain any combination of inorganic soil components from clay to boulders.
- <sup>6</sup> Weathered in place soil derived from parent rock material; characteristics vary depending on soil type.