

CONSTRUCTION WARNING SIGNS

CW1-1 to CW24-1B

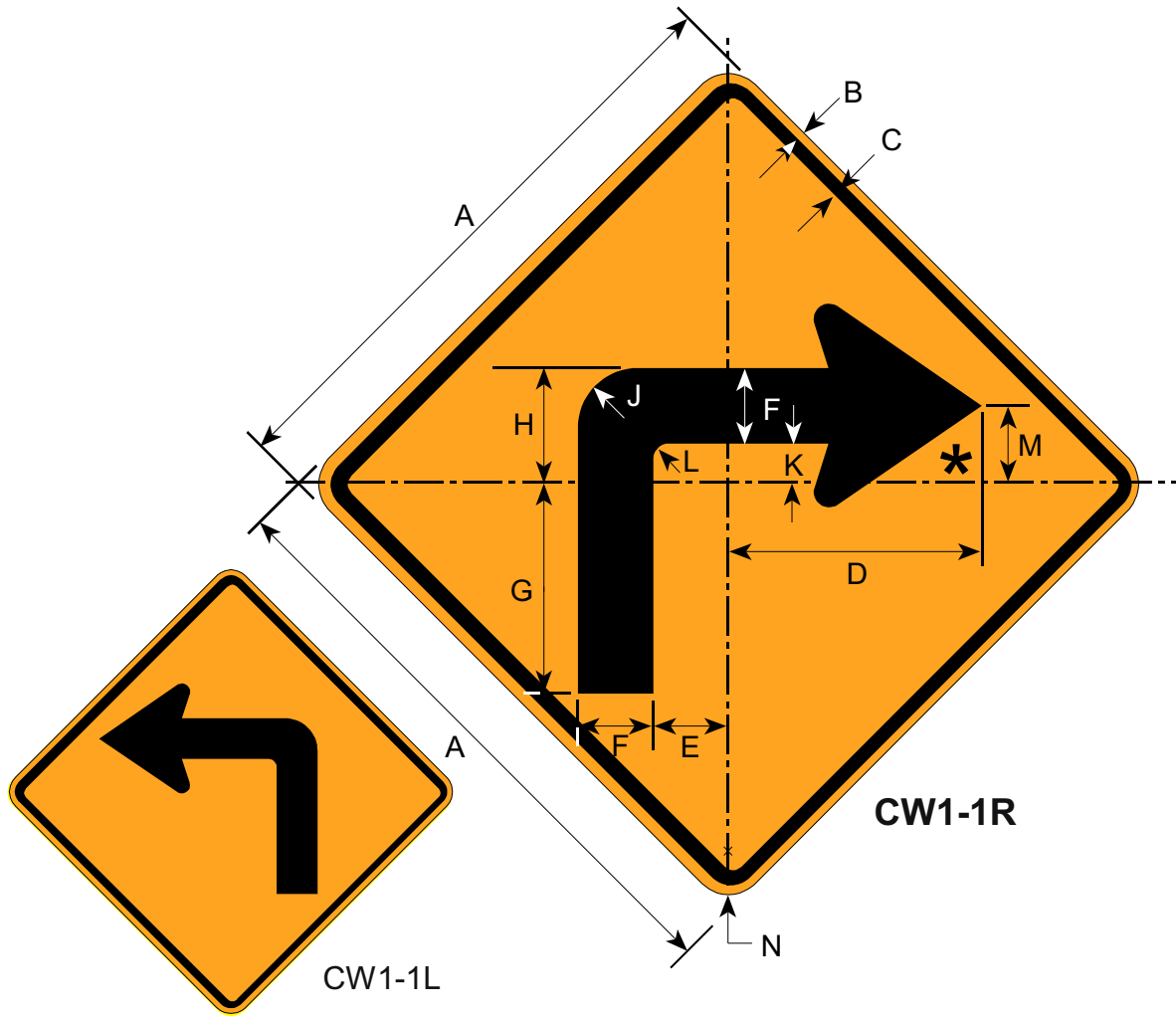

* See Appendix B-1 for Standard Arrow Details.

Border and Legend: Black
Background: Orange

Road Class	Dimensions (inches)												
	A	B	C	D	E	F	G	H	J	K	L	M	N
Bike	18	0.38	0.63	7.25	2.25	2.63	5.88	3.75	1.88	1.0	0.63	2.5	1.5
Minimum	30	0.50	0.75	12	3.75	4.38	9.69	6.25	3.0	1.88	1.0	4.06	1.88
Conventional	36	0.63	0.88	14.38	4.5	5.25	11.63	7.5	3.63	2.25	1.25	4.88	2.25
Expwy/Fwy	48	0.75	1.25	19.19	6.0	7.0	15.5	10	4.88	3.0	1.63	6.5	3.0

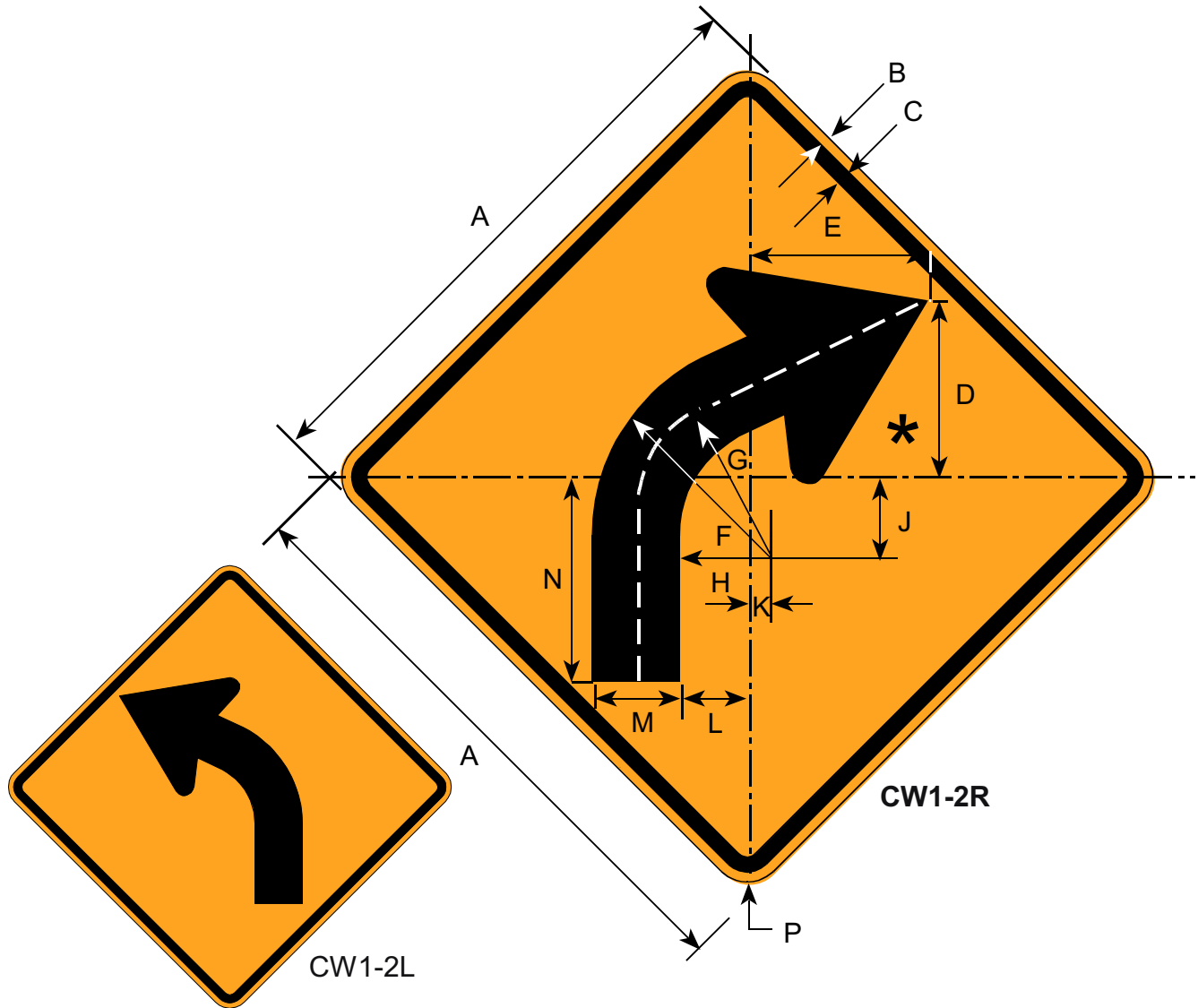

* See Appendix B-1 for Standard Arrow Details.

Border and Legend: Black
Background: Orange

Road Class	Dimensions (inches)													
	A	B	C	D	E	F	G	H	J	K	L	M	N	P
Bike	18	0.38	0.63	5.38	5.5	6.0	4.75	3.38	1.75	1.25	2.0	2.63	6.25	1.5
Minimum	30	0.50	0.75	8.88	9.06	10	7.81	5.63	2.94	2.19	3.44	4.38	10.31	1.88
Conventional	36	0.63	0.88	10.88	10.88	12	9.38	6.75	3.50	2.63	4.25	5.25	12.38	2.25
Expwy/Fwy	48	0.75	1.25	14.81	14.25	16	12.5	9.0	4.69	3.5	5.5	7.0	16.5	3.0

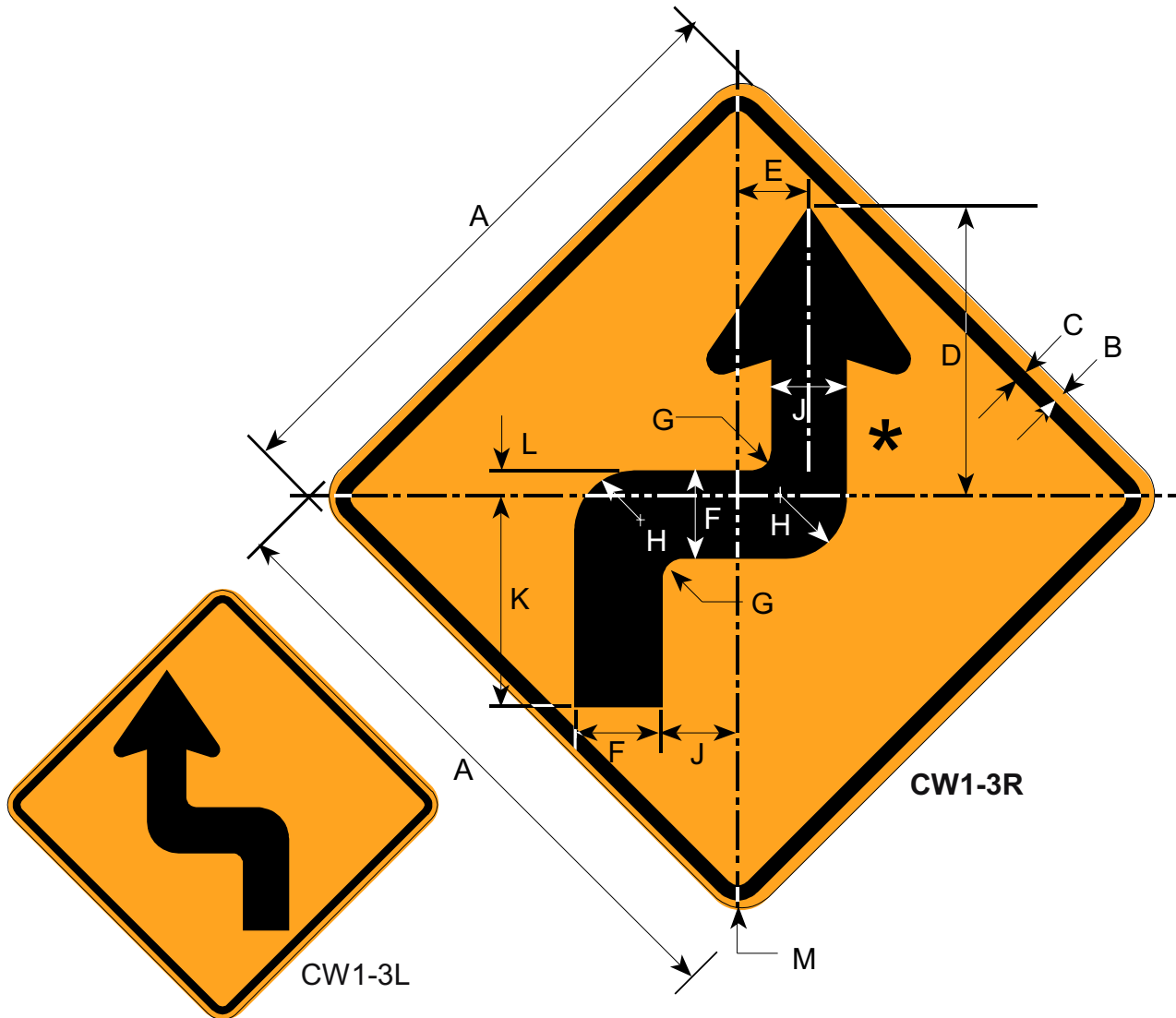

*See Appendix B-1 for Standard Arrow Details.

Border and Legend: Black
Background: Orange

Road Class	Dimensions (inches)											
	A	B	C	D	E	F	G	H	J	K	L	M
Minimum	30	0.50	0.75	14.5	3.5	4.38	1.0	3.0	3.75	10.38	1.38	1.88
Conventional	36	0.63	0.88	17.44	4.22	5.25	1.25	3.63	4.5	12.47	1.66	2.25
Expwy/Fwy	48	0.75	1.25	23.19	5.63	7.0	1.63	4.88	6.0	16.63	2.19	3.0

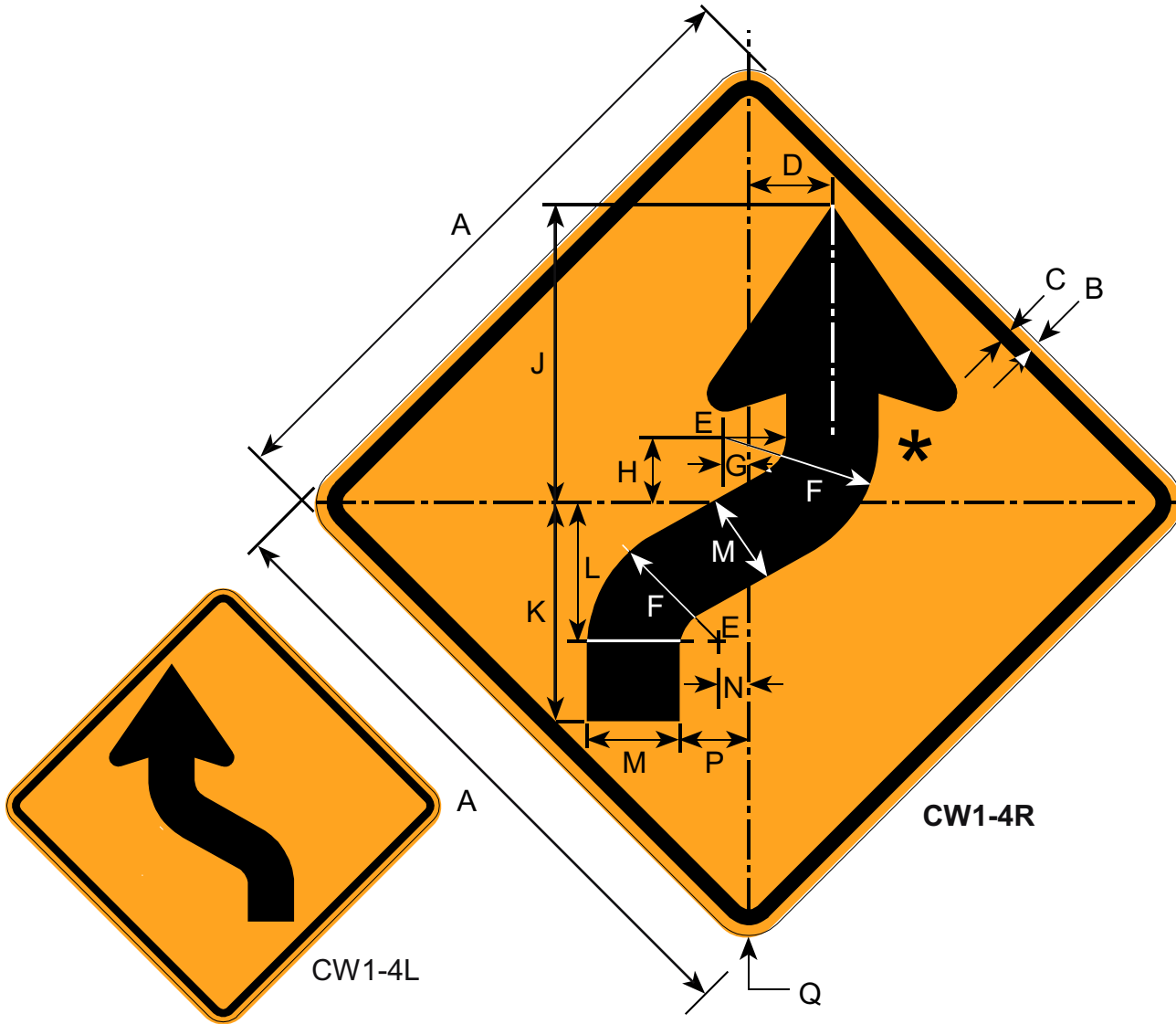

*See Appendix B-1 for Standard Arrow details.

Border and Legend: Black
Background: Orange

Road Class	Dimensions (inches)															
	A	B	C	D	E	F	G	H	J	K	L	M	N	P	Q	
Minimum	30	0.50	0.75	3.94	1.88	6.25	0.38	4.38	14.06	10.94	6.56	4.38	1.81	3.28	1.88	
Conventional	36	0.63	0.88	4.72	2.25	7.5	0.47	5.25	16.88	12.38	7.88	5.25	1.69	3.94	2.25	
Expwy/Fwy	48	0.75	1.25	6.31	3.0	10	0.63	7.0	22.5	16.5	10.5	7.0	2.25	5.25	3.0	

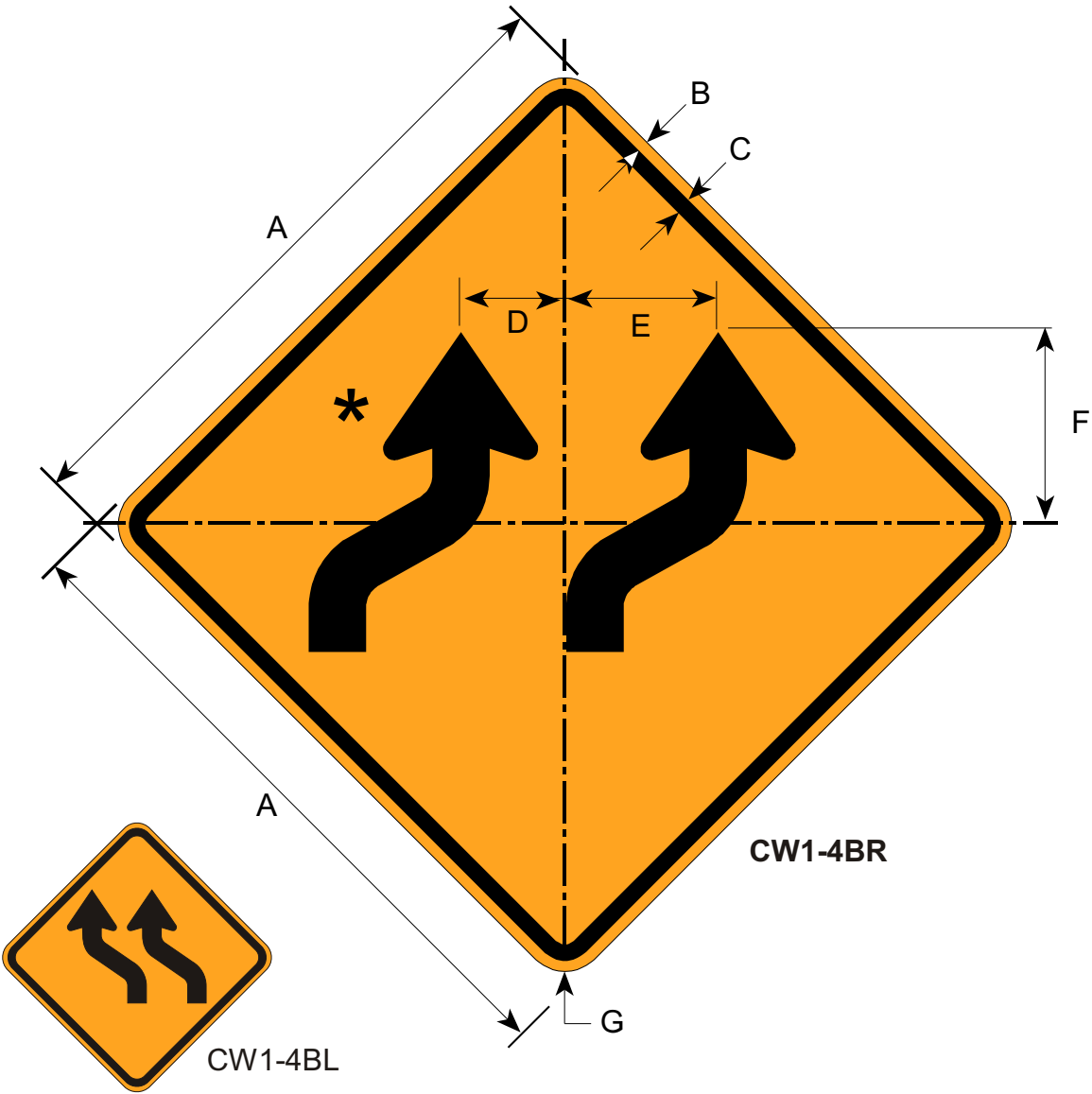

*Make arrows proportional to arrow shown in CW1-4 and reduce them to 57% of its size.

Border and Legend: Black
Background: Orange

Road Class	Dimensions (inches)						
	A	B	C	D	E	F	G
Minimum	30	0.50	0.75	2.24	6.81	10.25	1.88
Conventional	36	0.63	0.88	3.04	8.53	12.89	2.25
Expwy/Fwy	48	0.75	1.25	4.24	10.25	15.37	3.0

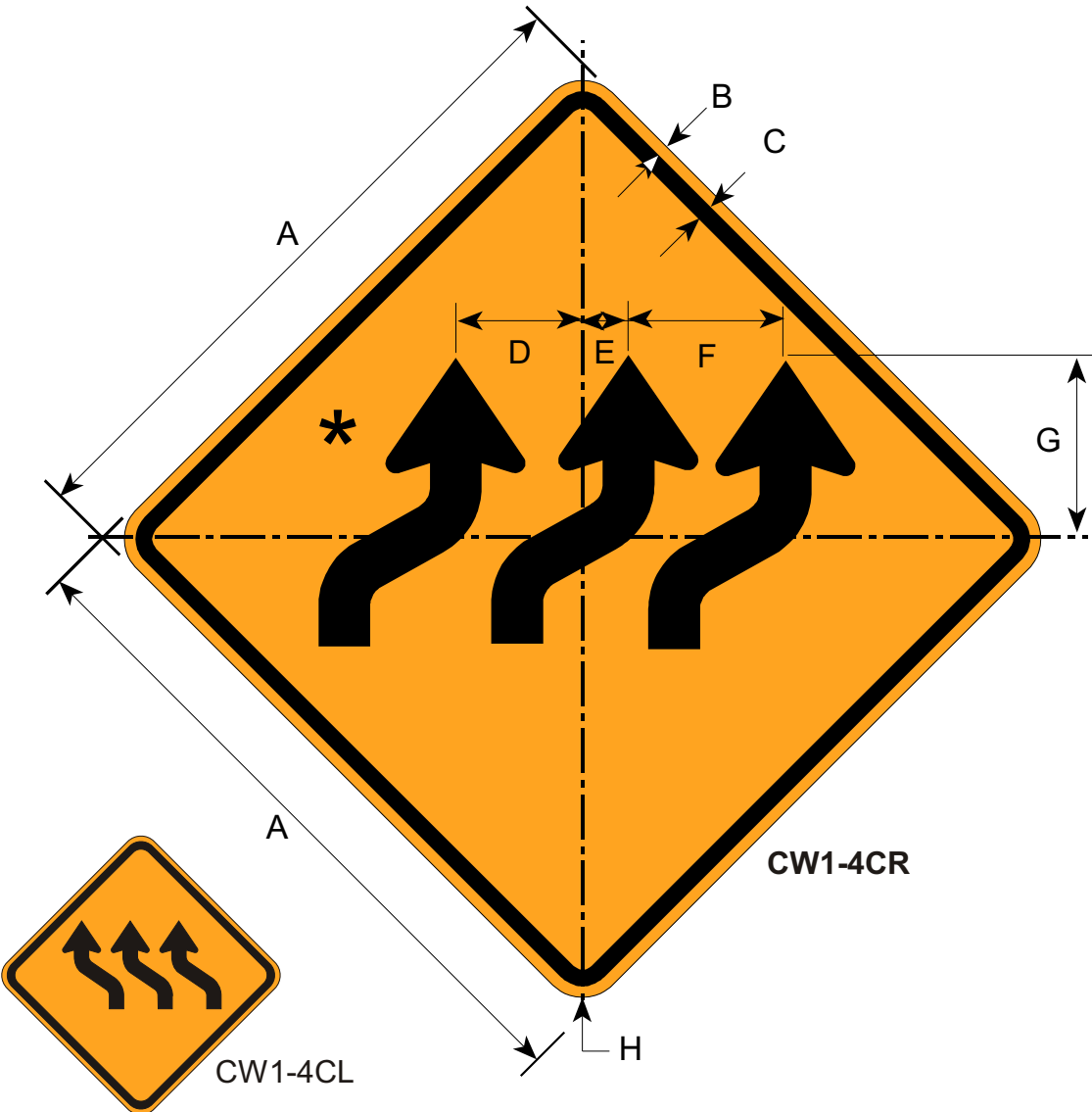

*Make arrows proportional to arrow shown in CW1-4 and reduce them to 53% of its size.

Border and Legend: Black
Background: Orange

Road Class	Dimensions (inches)							
	A	B	C	D	E	F	G	H
Minimum	30	0.50	0.75	5.4	1.48	7.25	8.57	1.88
Conventional	36	0.63	0.88	7.13	1.64	9.29	10.77	2.25
Expwy/Fwy	48	0.75	1.25	8.89	2.48	11.4	12.81	3.0

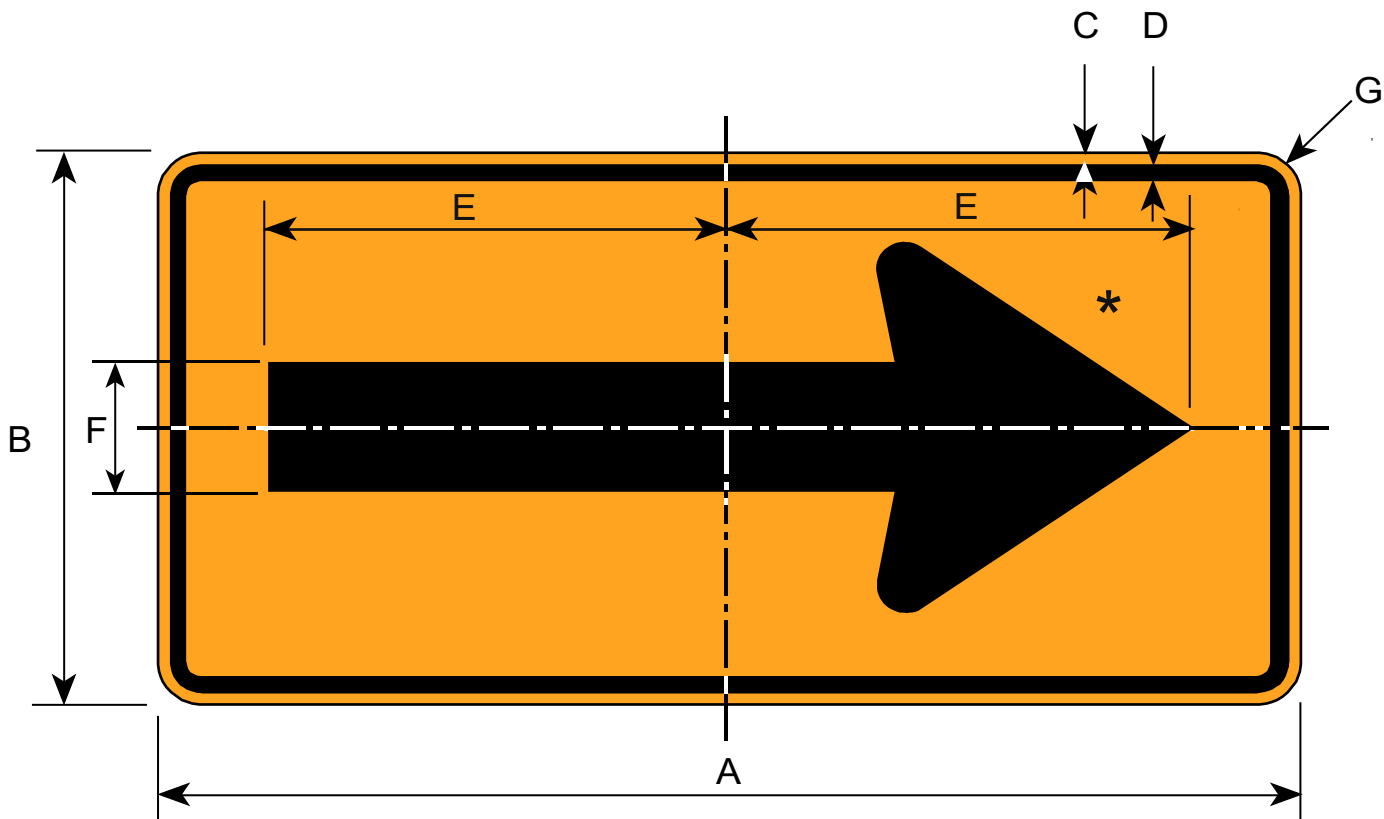

CW1-6R



CW1-6L

* See Appendix B-1 for Standard Arrow Details.

Border and Legend: Black
Background: Orange

Road Class	Dimensions (inches)						
	A	B	C	D	E	F	G
Bike	24	12	0.38	0.63	9.63	3.25	1.5
Minimum	36	18	0.38	0.63	14.63	5.0	1.5
Conventional	48	24	0.50	0.75	19.5	6.5	1.88
Expwy/Fwy	60	30	0.63	0.88	24.38	8.0	2.25

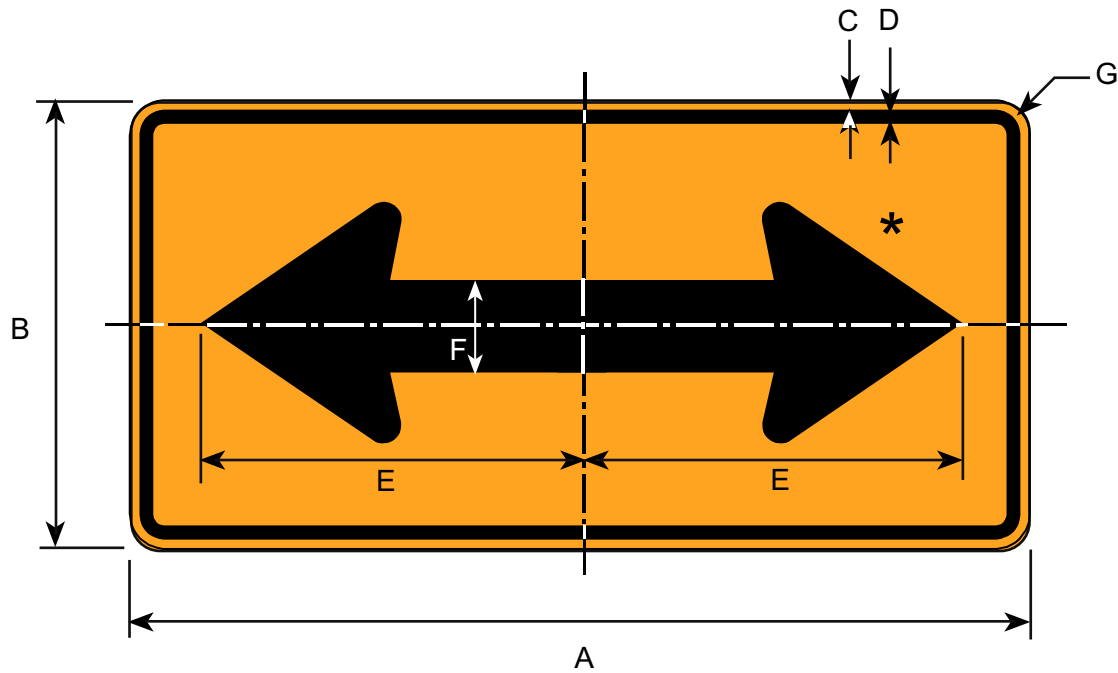

* See Appendix B-1 for Standard Arrow Details.

Border and Legend: Black
Background: Orange

Road Class	Dimensions (inches)						
	A	B	C	D	E	F	G
Bike	24	12	0.38	0.63	10.38	3.25	1.5
Minimum	36	18	0.38	0.63	15.63	5.0	1.5
Conventional	48	24	0.50	0.75	20.5	6.5	1.88
Expwy/Fwy	60	30	0.63	0.88	25.38	8.0	2.25
Oversized	96	48	0.75	1.25	41	12.5	3

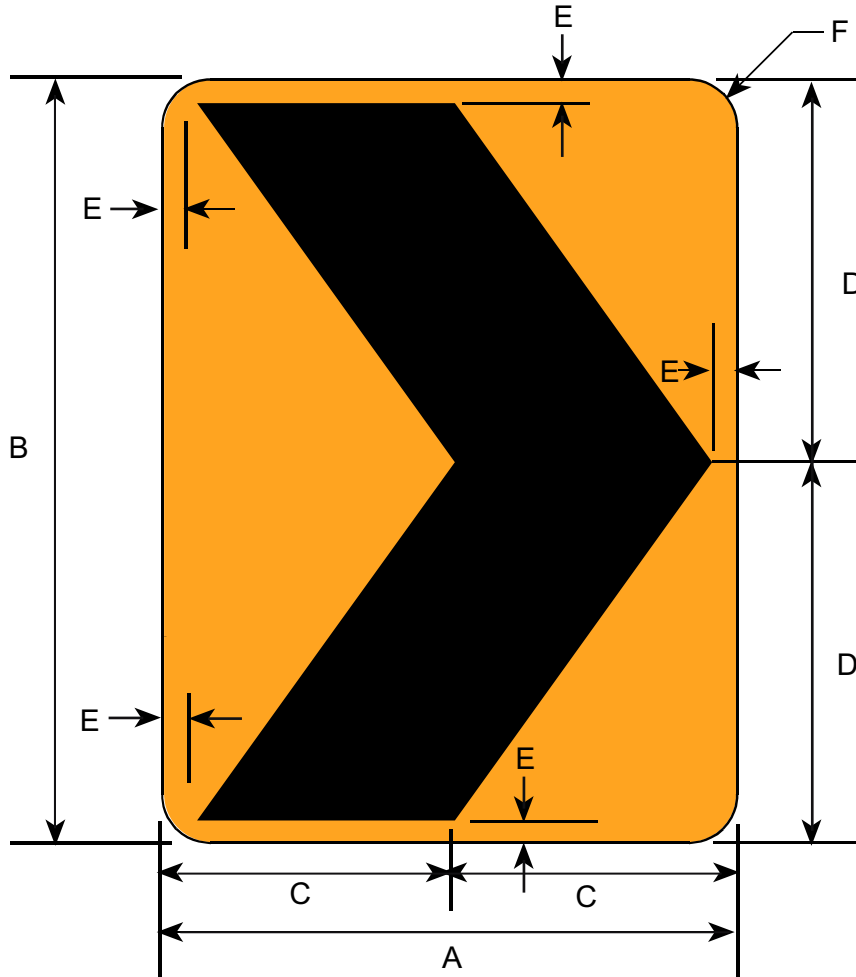

CW1-8R



CW1-8L

Border and Legend: Black
Background: Orange

Road Class	Dimensions (inches)					
	A	B	C	D	E	F
Bike	12	18	6.0	9.0	0.50	1.5
Minimum	18	24	9.0	12	0.75	1.5
Conventional	24	30	12	15	0.88	1.5
Expwy	30	36	15	18	1.0	1.88
Freeway	36	48	18	24	1.13	2.25

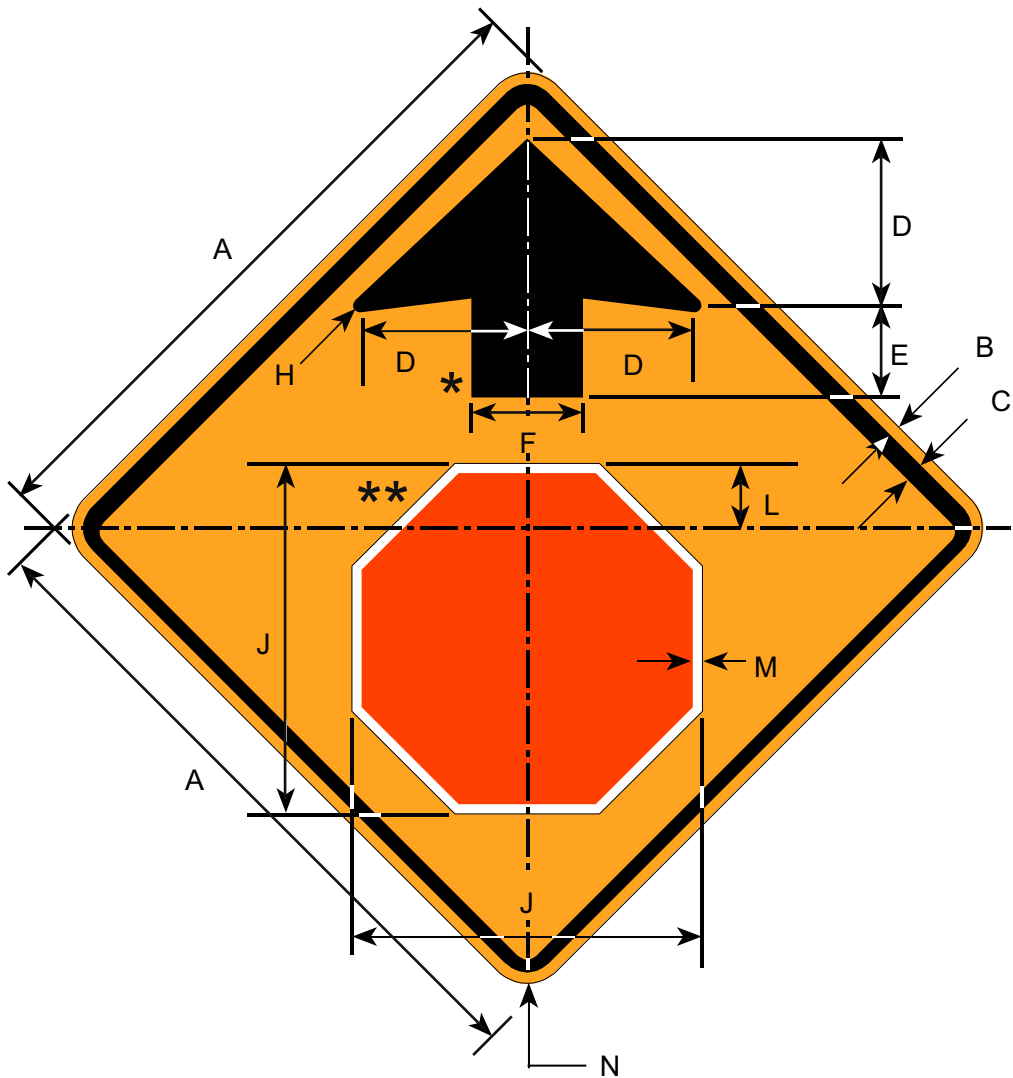

Border and Legend: Black
 Background: Orange
 Symbol: White Border on Red Background

* See Appendix B-3 for Arrow Details.
 ** Make Symbol proportional to graphic shown.

Road Class	Dimensions (inches)										
	A	B	C	D	E	F	H	J	L	M	N
Minimum	30	0.50	0.75	7.5	3.75	5	0.31	15.75	2.88	0.50	1.88
Standard	36	0.63	0.88	9.0	4.5	6	0.38	19	3.5	0.63	2.25
Expwy/Fwy	48	0.75	1.25	12	6.0	8	0.50	25.13	4.5	0.75	3.0

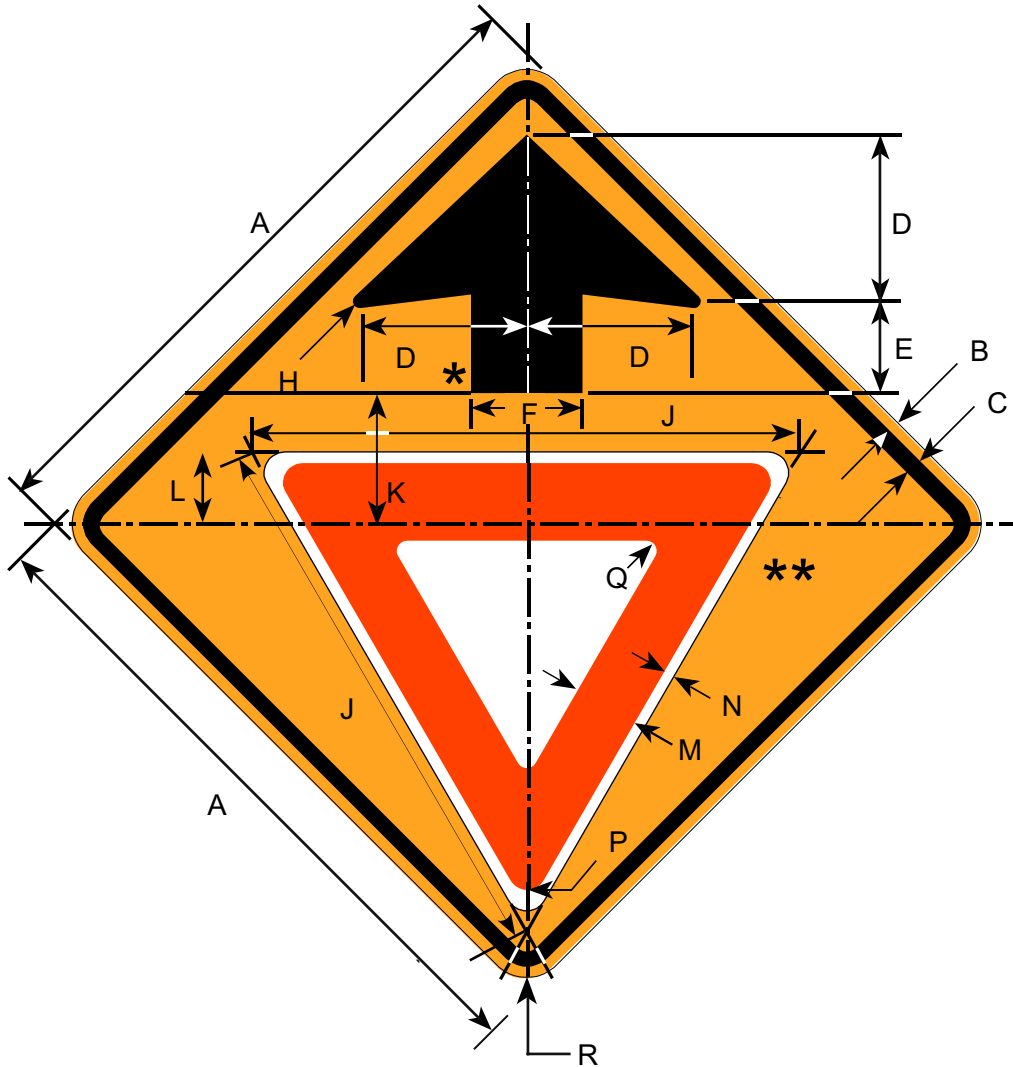

Border and Legend: Black
 Background: Orange
 Symbol: Red Border on White Background

* See Appendix B-3 for Arrow Details.
 ** Make Symbol proportional to graphic shown.

Road Class	Dimensions (inches)														
	A	B	C	D	E	F	H	J	K	L	M	N	P	Q	R
Minimum	30	0.50	0.75	7.5	3.75	5.0	0.31	25	6.25	3.0	3.38	0.50	1.25	0.63	1.88
Conventional	36	0.63	0.88	9.0	4.5	6.0	0.38	28	7.5	3.38	3.75	0.63	1.38	0.75	2.25
Expwy/Fwy	48	0.75	1.25	12	6.0	8.0	0.50	38	10	4.5	5.0	0.75	1.88	1.0	3.0

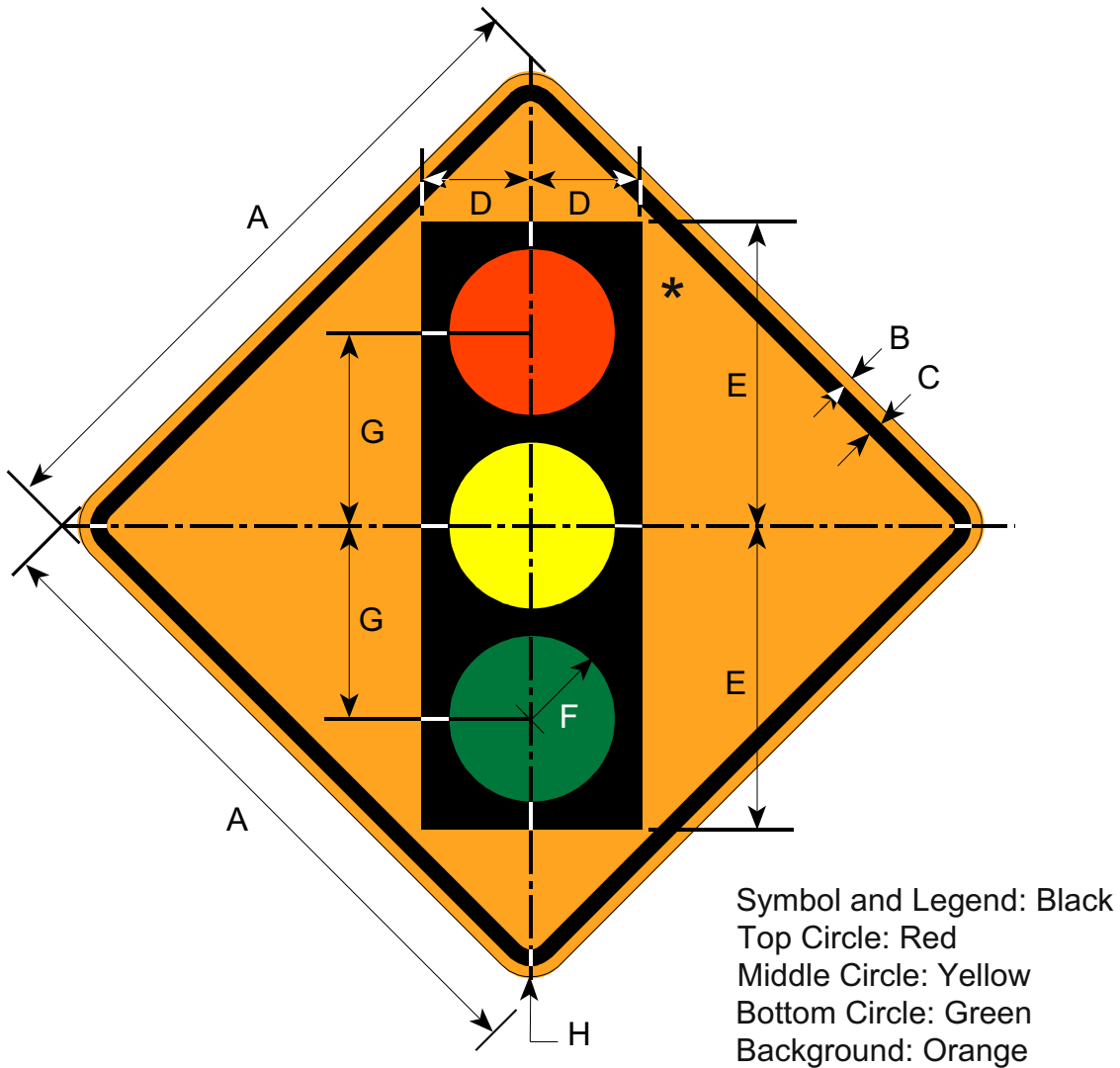

Prior to 2002 publication of this manual, this sign was numbered CW3-3B.

* Make Symbol proportional to graphic shown.

Road Class	Dimensions (inches)							
	A	B	C	D	E	F	G	H
Bike	18	0.38	0.63	3.0	8.0	2.25	5.0	1.50
Minimum	30	0.50	0.75	5.0	13.75	3.75	8.75	1.88
Conventional	36	0.63	0.88	5.75	15.75	4.25	10	2.25
Expwy/Fwy	48	0.75	1.25	7.5	20	5.0	12.5	3.0

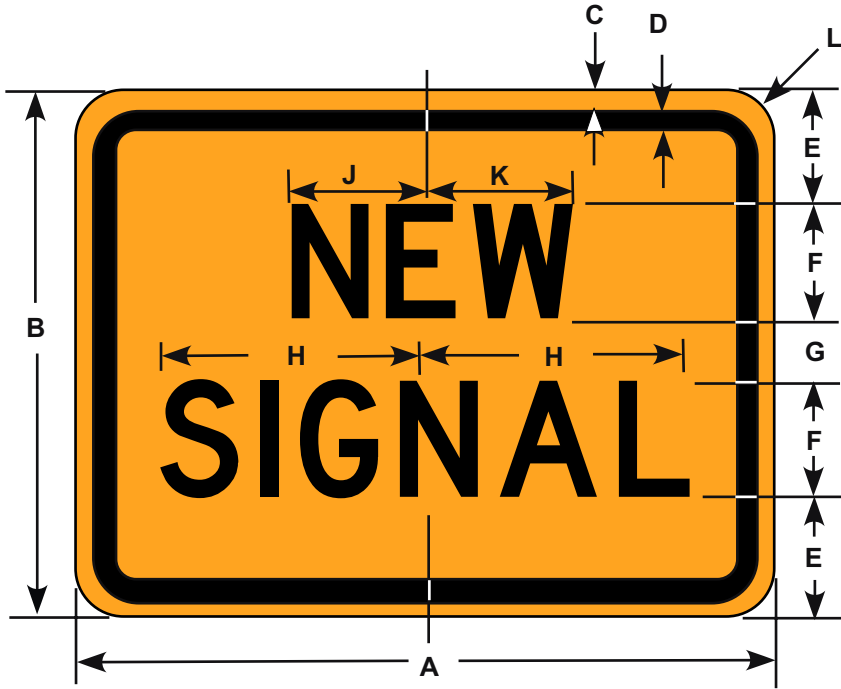

Border and Legend: Black
 Background: Orange

This sign shall be used with CW3-3 Signal Ahead.

Road Class	Dimensions (inches)										
	A	B	C	D	E	F	G	H	J	K	L
Conventional	24	18	0.38	0.63	4	4D	2	9.38	5.06	5	1.50

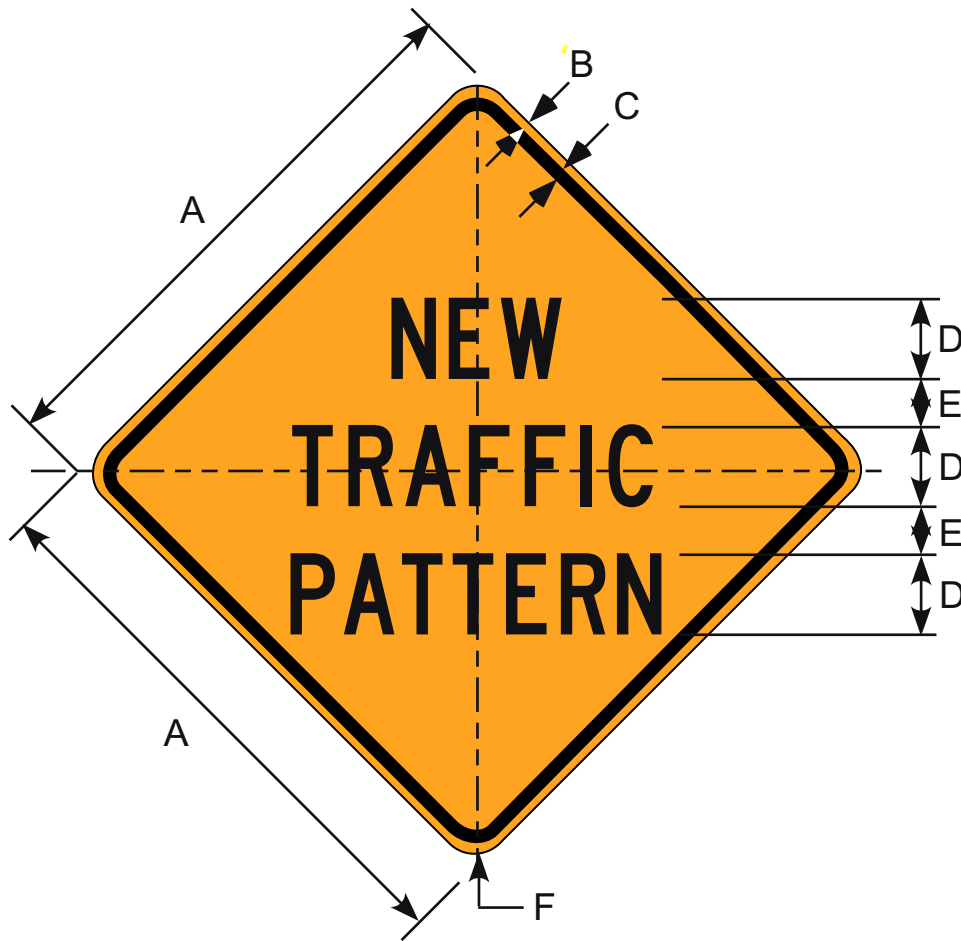

Border and Legend: Black
 Background: Orange

Prior to the 2003 revision of this manual this sign was numbered W3-100.
 This sign replaces former SIGNAL REVISION (CW21-9) and TRAFFIC REVISION (CW21-10) signs.

Road Class	Dimensions (inches)					
	A	B	C	D	E	F
Minimum	30	0.50	0.75	4C	2.5	1.88
Conventional	36	0.63	0.88	5C	3.0	2.25
Expwy/Fwy	48	0.75	1.25	7C	4.0	3.0

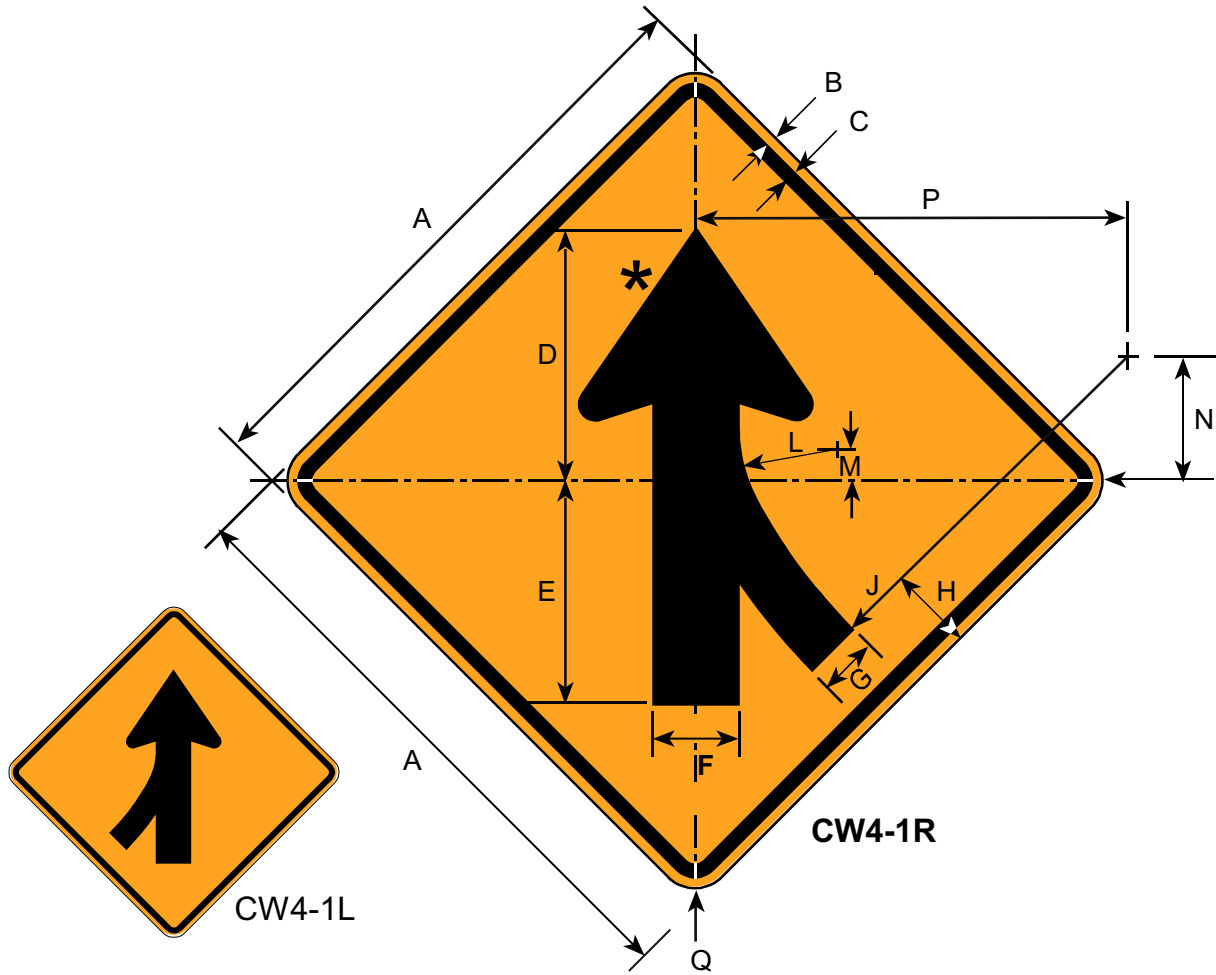

* See Appendix B-1 for Standard Arrow Details.

Border and Legend: Black
Background: Orange

Road Class	Dimensions (inches)													
	A	B	C	D	E	F	G	H	J	L	M	N	P	Q
Minimum	30	0.50	0.75	13	11	4.38	3.0	5.25	28	8.0	3.0	13	27.75	1.88
Conventional	36	0.63	0.88	15.75	13.25	5.25	3.63	6.31	33.63	9.63	4.0	15.63	35.31	2.25
Expwy/Fwy	48	0.75	1.25	20.5	17.5	7.0	4.75	8.38	45	12.81	5.25	20.75	44.38	3.0

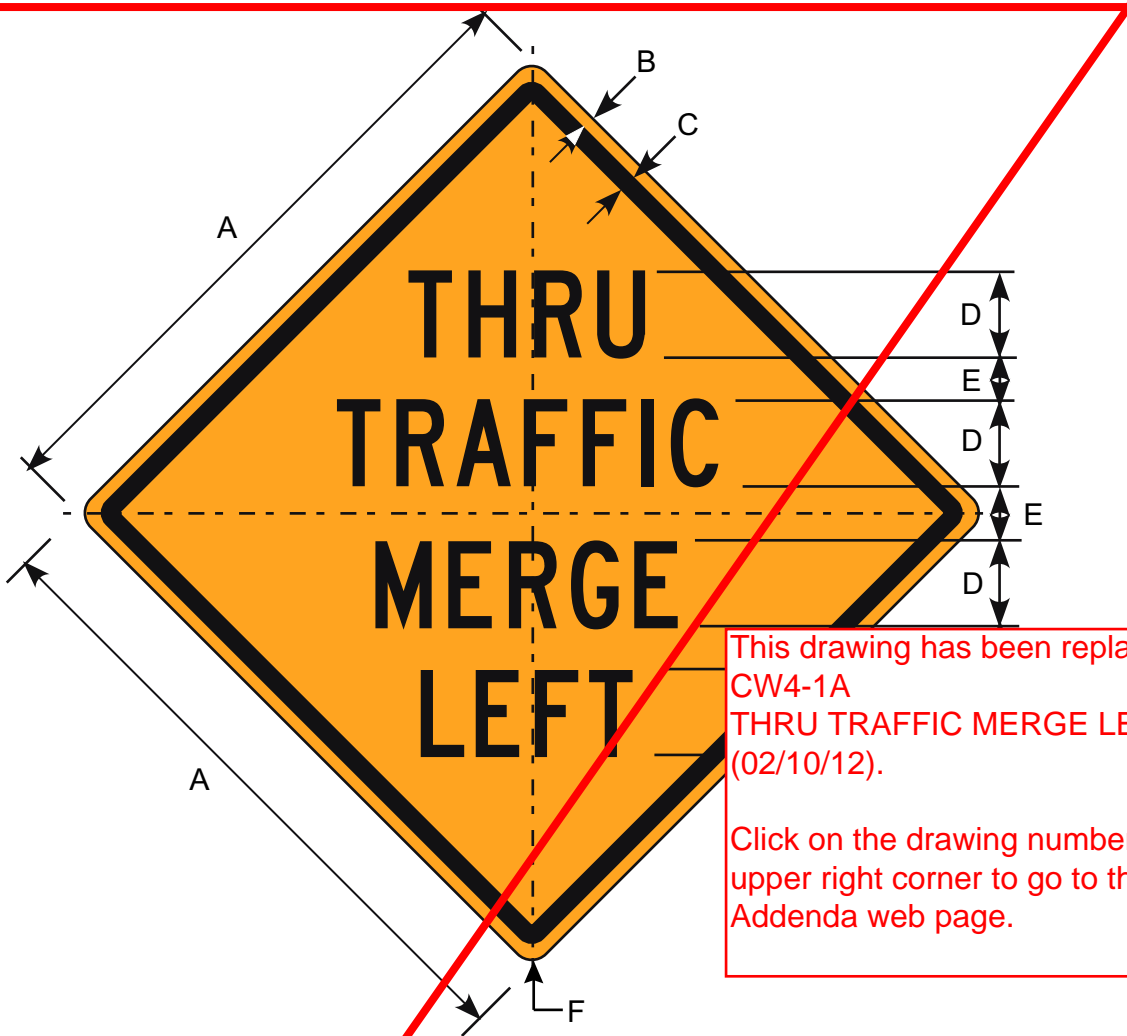

This drawing has been replaced with:
CW4-1A
THRU TRAFFIC MERGE LEFT
 (02/10/12).

Click on the drawing number in the upper right corner to go to the Interim Addenda web page.

Border and Legend: Black
 Background: Orange

Road Class	Dimensions (inches)					
	A	B	C	D	E	F
Minimum	36	0.63	0.88	5C	2.5	2.25
Conventional	48	0.75	1.25	6C	3.0	3.0
Expwy/Fwy	60	1.0	1.5	8C	4.0	3.75

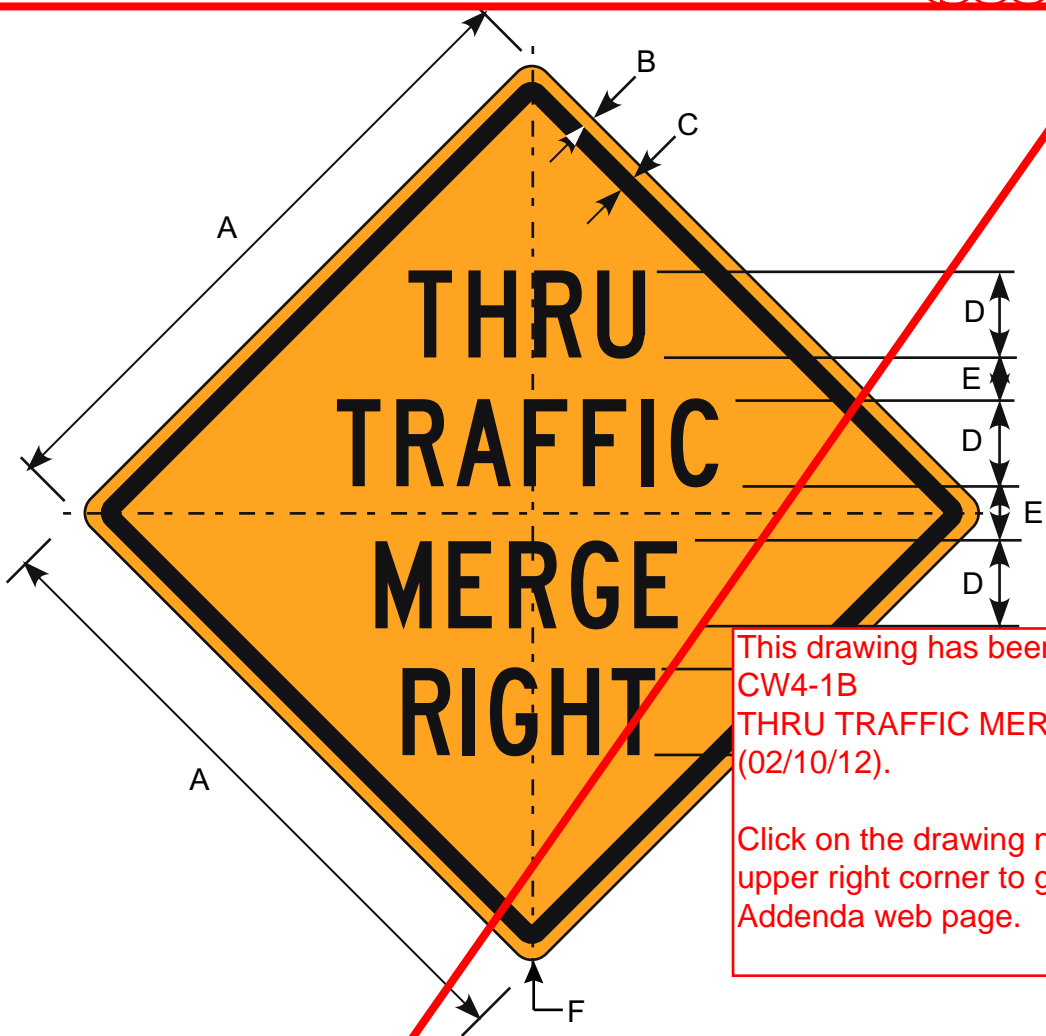

This drawing has been replaced with:
CW4-1B
THRU TRAFFIC MERGE RIGHT
 (02/10/12).

Click on the drawing number in the upper right corner to go to the Interim Addenda web page.

Border and Legend: Black
 Background: Orange

Road Class	Dimensions (inches)					
	A	B	C	D	E	F
Minimum	36	0.63	0.88	5C	2.5	2.25
Conventional	48	0.75	1.25	6C	3.0	3.0
Expwy/Fwy	60	1.0	1.5	8C	4.0	3.75

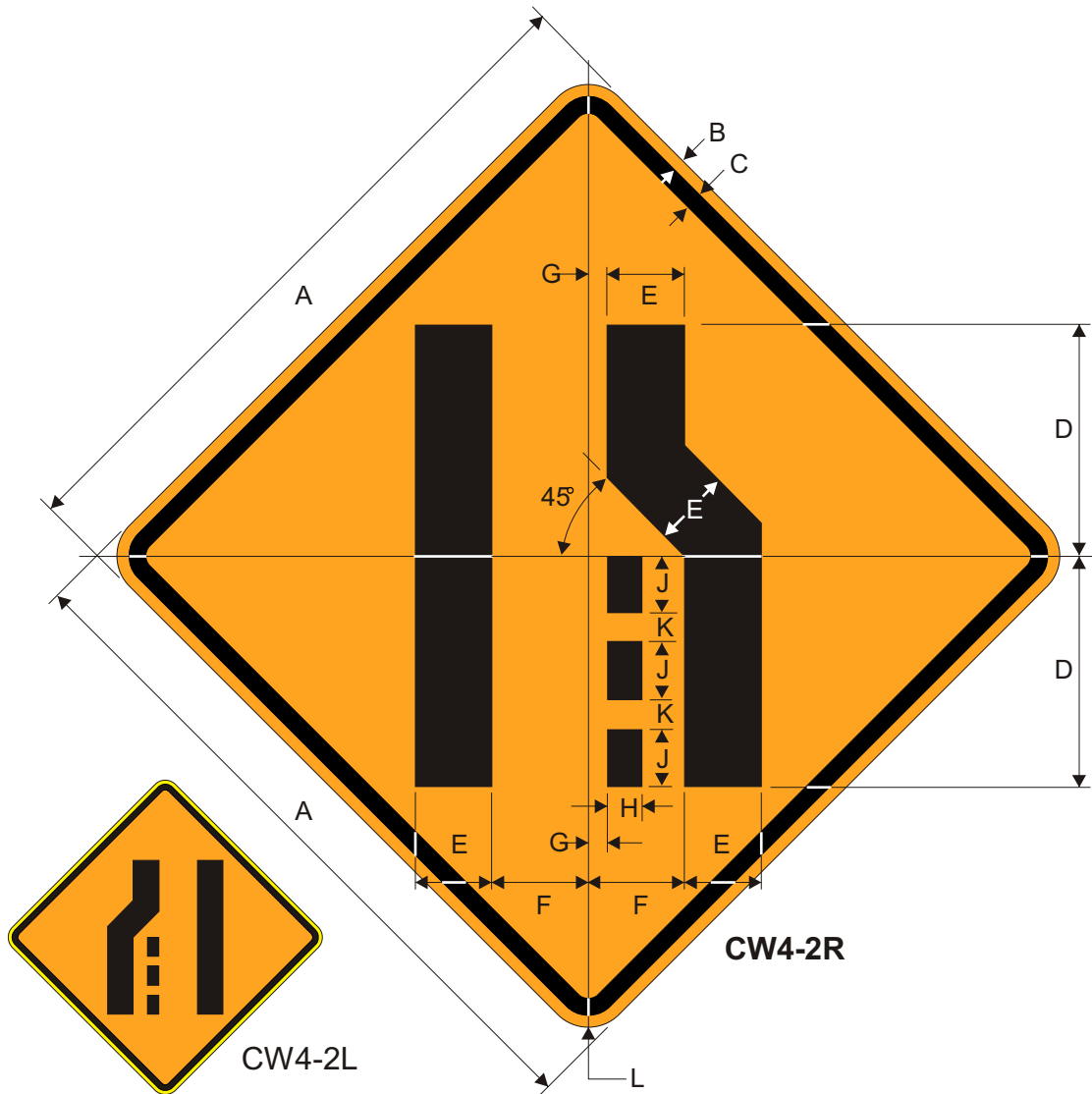

Border and Legend: Black
Background: Orange

Road Class	Dimensions (inches)										
	A	B	C	D	E	F	G	H	J	K	L
Minimum	30	0.5	0.75	10	3.38	4.19	0.88	1.5	2.5	1.25	1.88
Conventional	36	0.63	0.88	12	4.0	5.0	1.0	1.75	3.0	1.5	2.25
Expy/Fwy	48	0.75	1.25	16	5.38	6.69	1.25	2.38	4.0	2.0	3.0

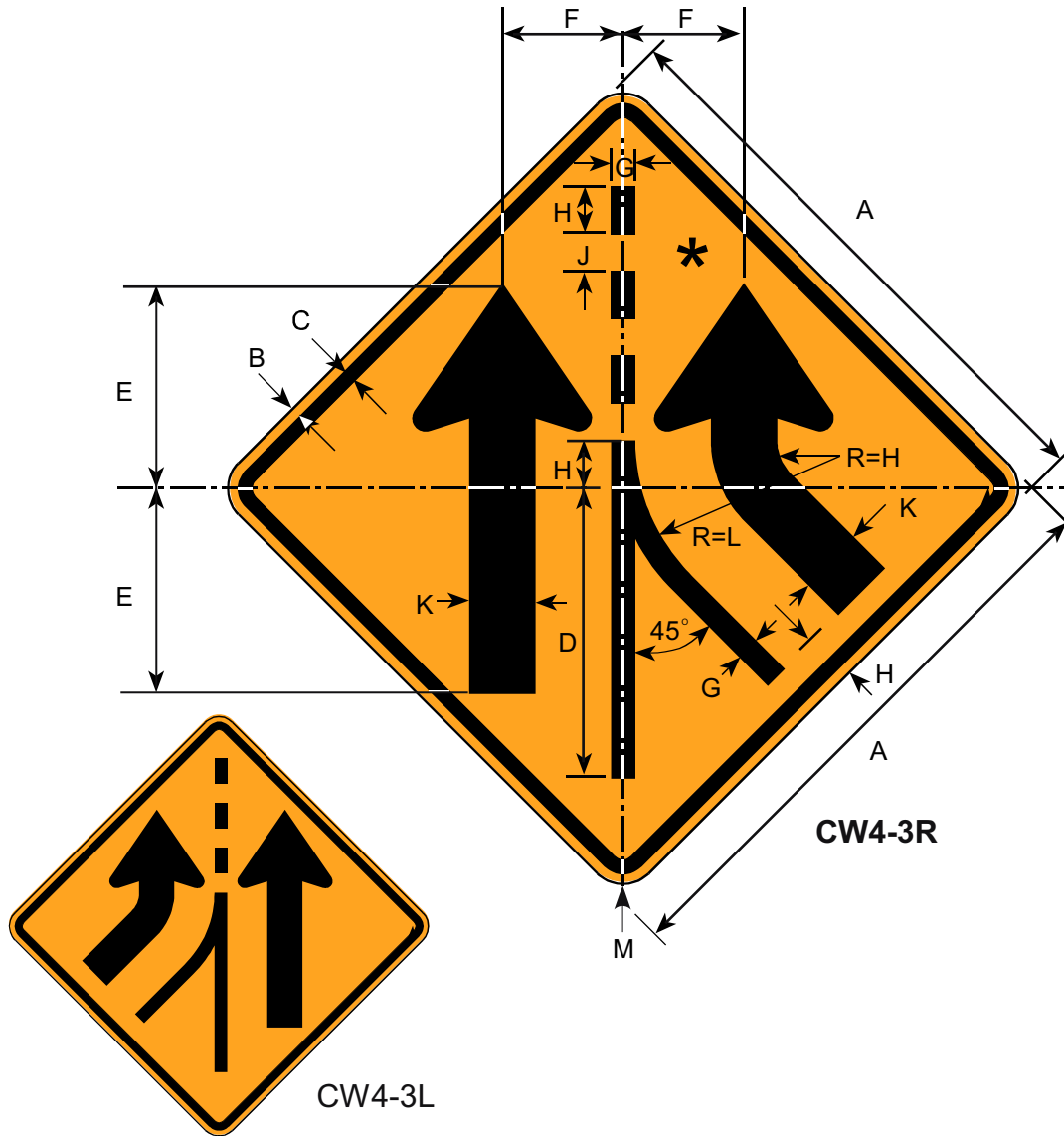

* See Appendix B-1 for Standard Arrow Details.

Border and Legend: Black
Background: Orange

Road Class	Dimensions (inches)											
	A	B	C	D	E	F	G	H	J	K	L	M
Expwy/Fwy	48	0.75	1.25	24	17	10	2.0	4.0	3.0	5.5	15.75	3.0

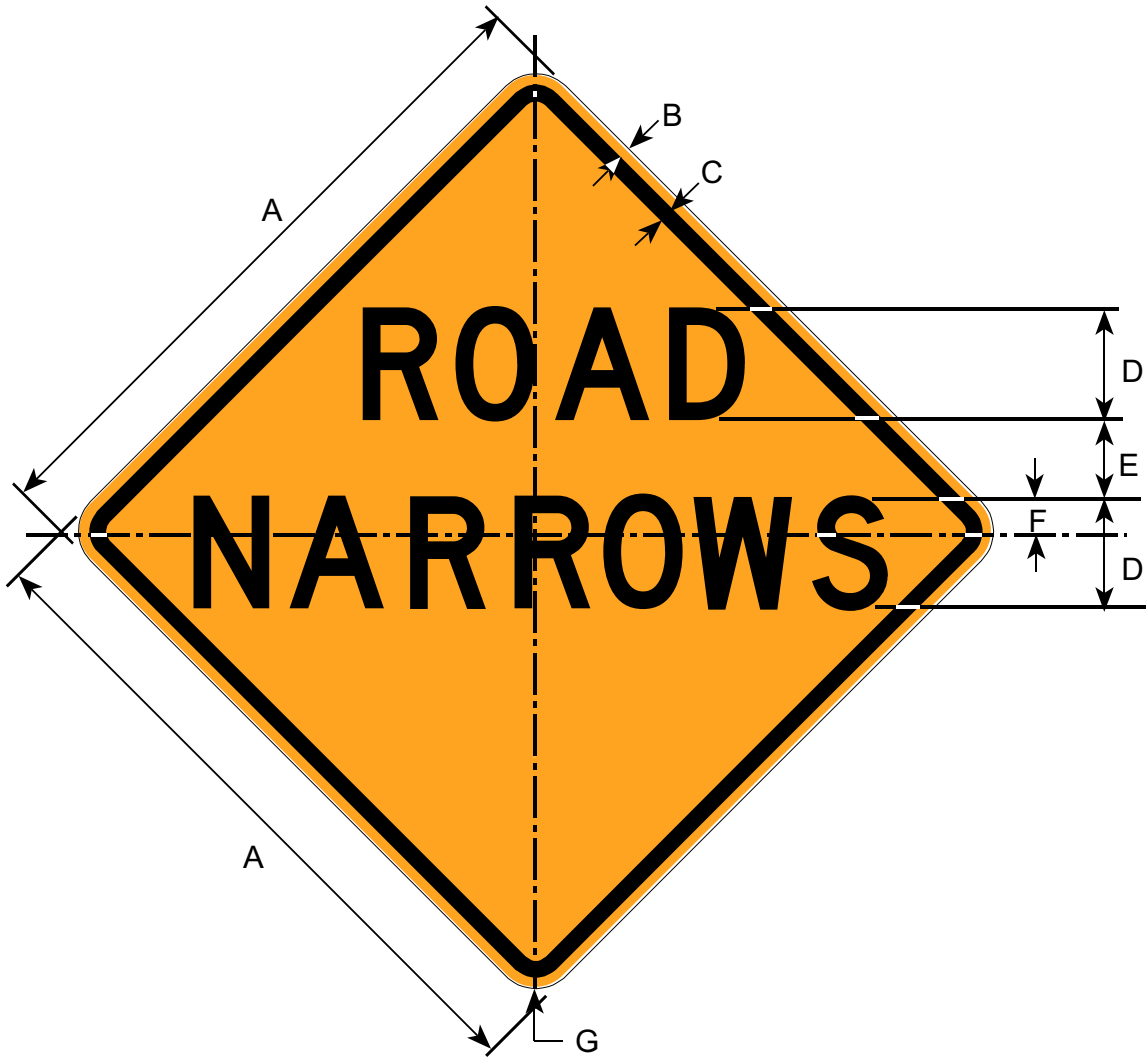

Border and Legend: Black
 Background: Orange

Road Class	Dimensions (inches)						
	A	B	C	D	E	F	G
Minimum	30	0.50	0.75	5D	3.0	1.75	1.88
Conventional	36	0.63	0.88	6D	3.5	2.0	2.25
Expwy/Fwy	48	0.75	1.25	8D	4.0	3.0	3.0

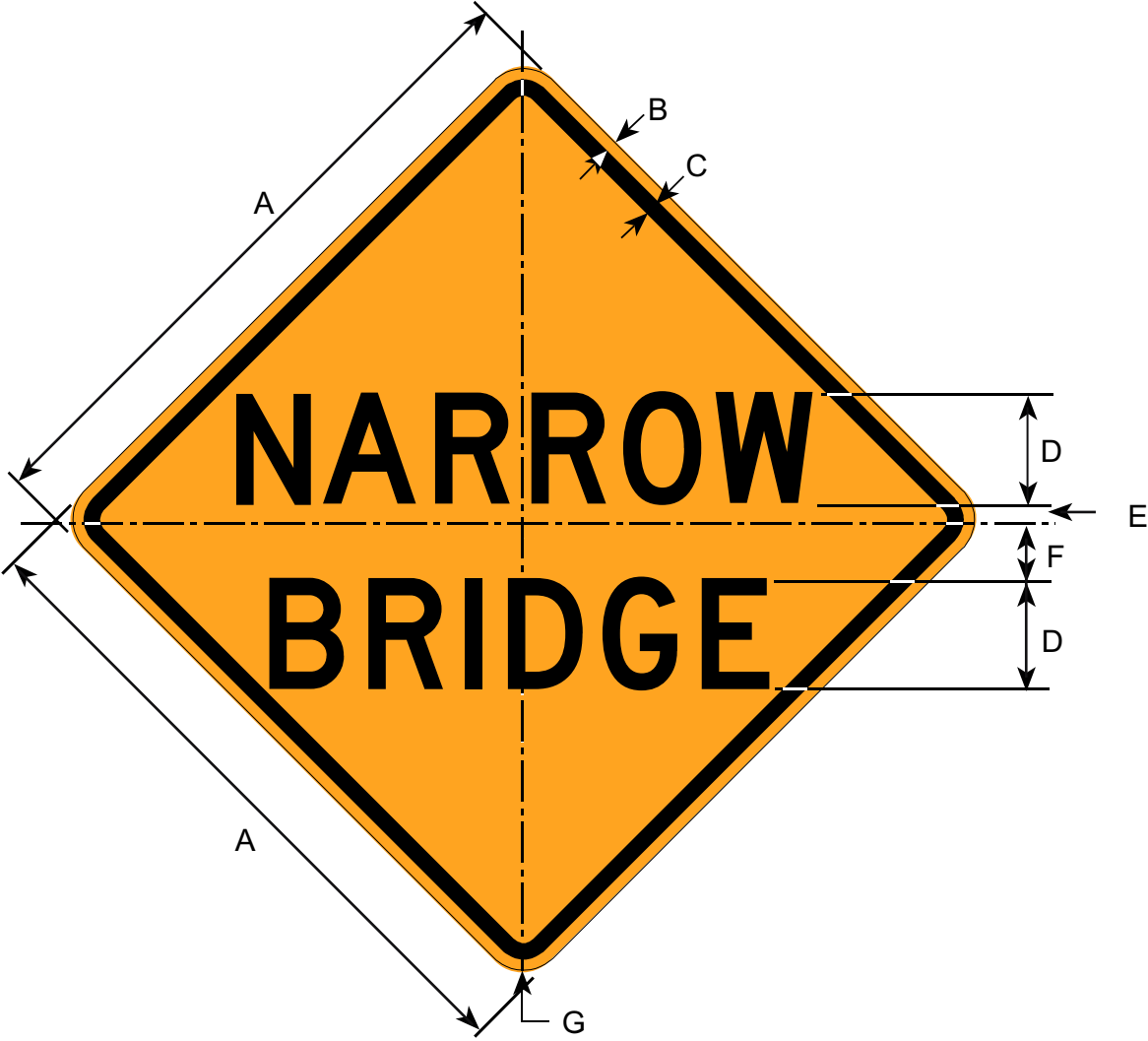

Border and Legend: Black
 Background: Orange

Road Class	Dimensions (inches)						
	A	B	C	D	E	F	G
Minimum	30	0.50	0.75	5D	0.50	2.5	1.88
Conventional	36	0.63	0.88	6D	0.75	3.0	2.25
Expwy/Fwy	48	0.75	1.25	8C	2.0	3.3	3.0

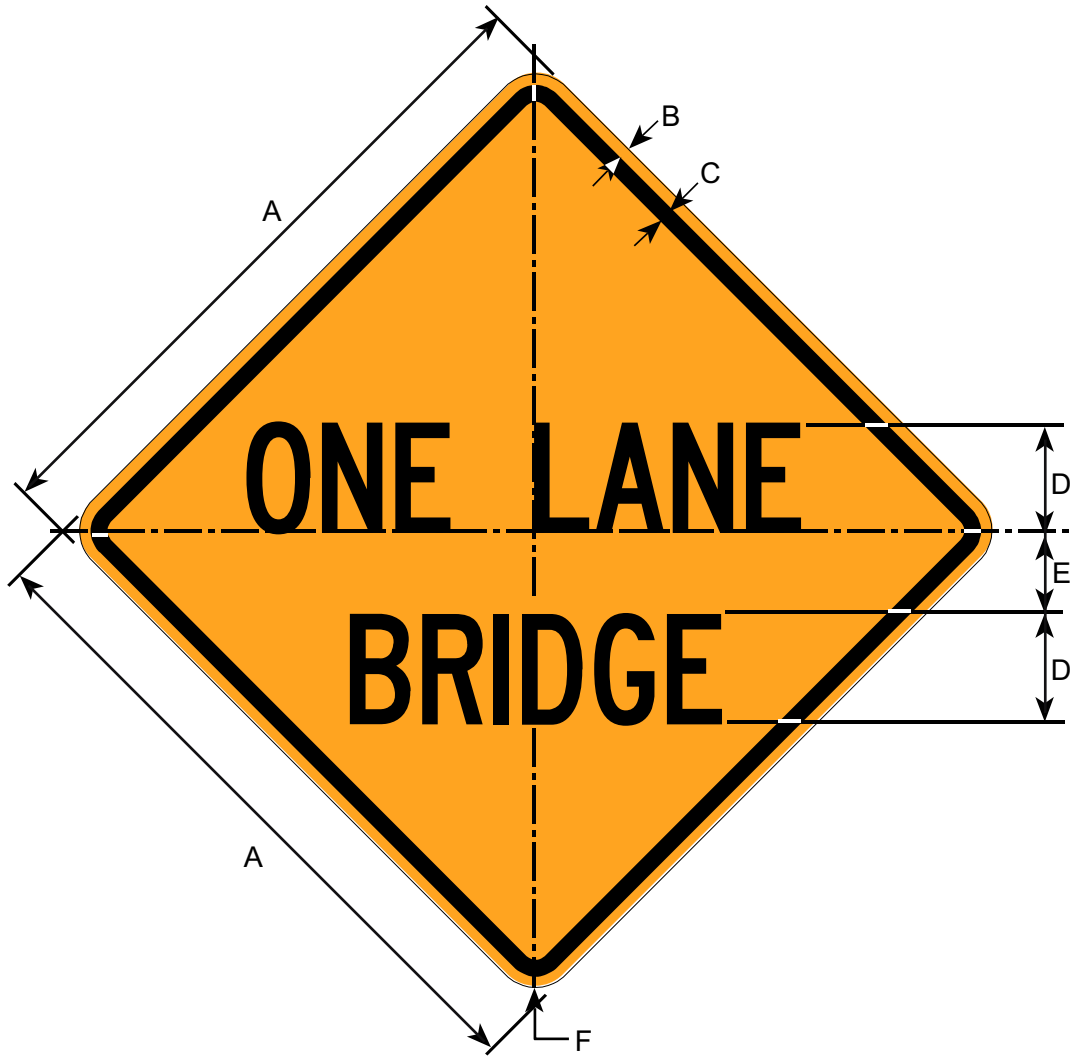

Border and Legend: Black
Background: Orange

Road Class	Dimensions (inches)					
	A	B	C	D	E	F
Minimum	30	0.50	0.75	5C	3.25	1.88
Conventional	36	0.63	0.88	6C	4.00	2.25
Expwy/Fwy	48	0.75	1.25	8C	5.00	3.00

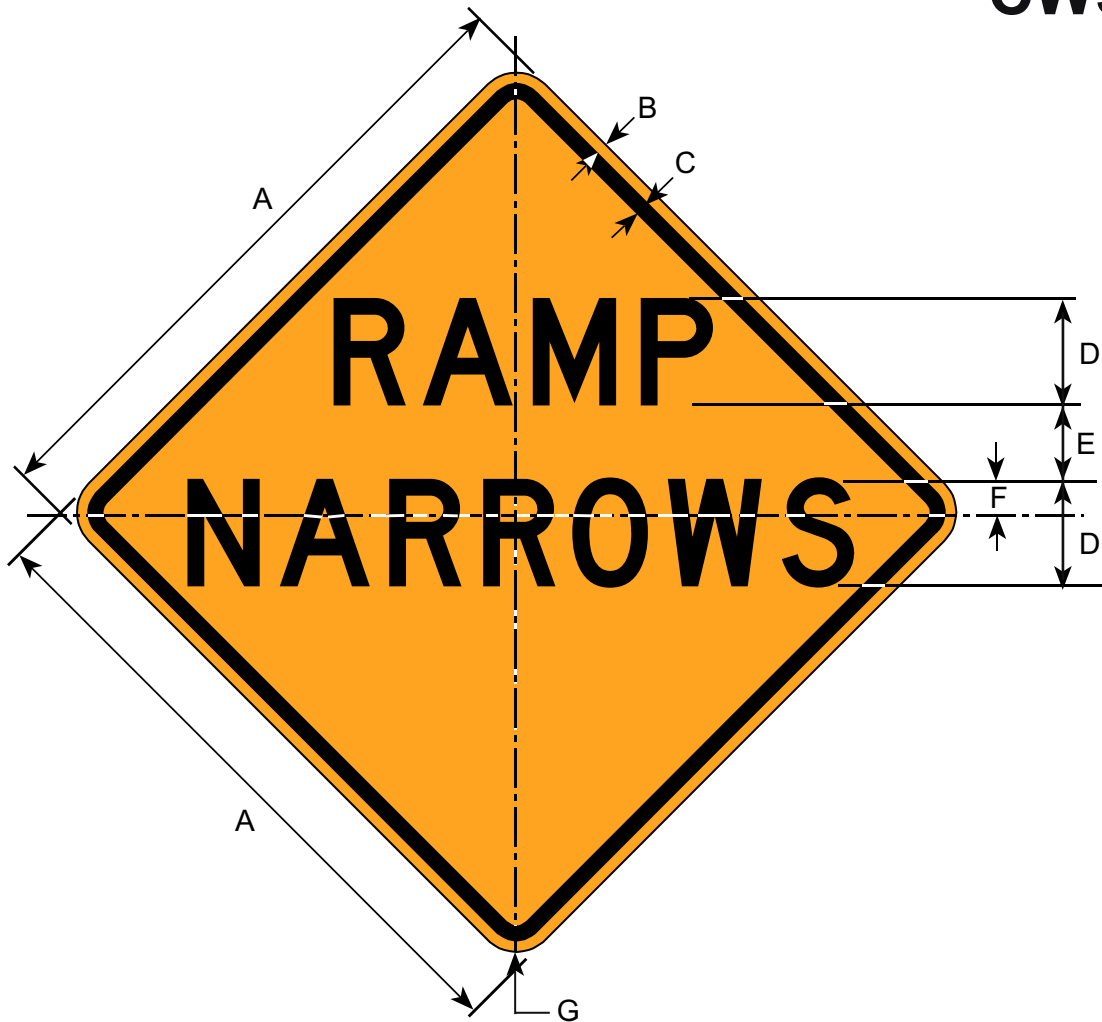

Border and Legend: Black
 Background: Orange

Road Class	Dimensions (inches)						
	A	B	C	D	E	F	G
Minimum	30	0.50	0.75	5D	3.0	1.75	1.88
Conventional	36	0.63	0.88	6D	3.50	2.0	2.50
Expwy/Fwy	48	0.75	1.25	8D	4.0	3.0	3.0

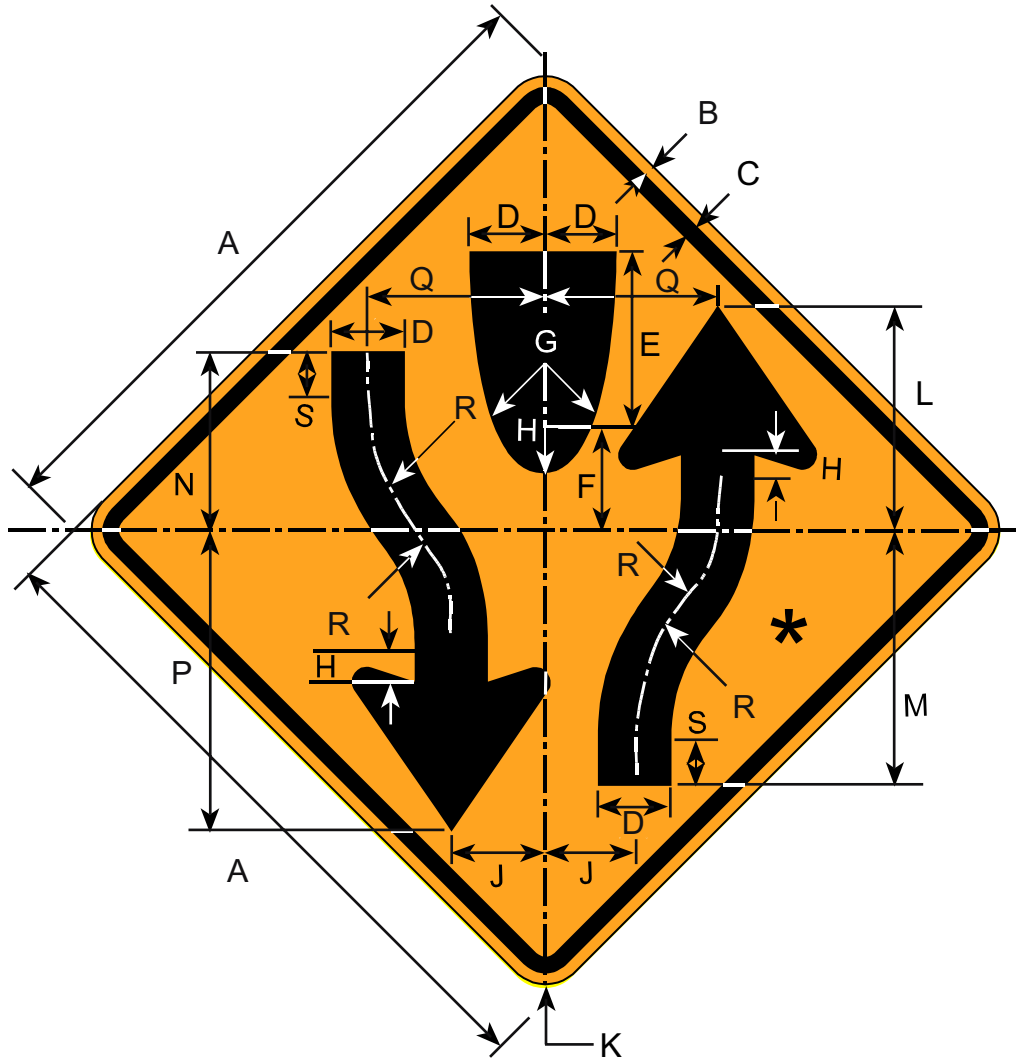

Border and Legend: Black
Background: Orange

* See Appendix B-1 for
Standard Arrow Details.

Road Class	Dimensions (inches)										
	A	B	C	D	E	F	G	H	J	K	L
Minimum	30	0.50	0.75	3.31	8.31	4.13	25	1.69	4.13	1.88	10
Conventional	36	0.63	0.88	4.0	10	5.0	30	2.0	5.0	2.25	12
Expwy/Fwy	48	0.75	1.25	5.25	13.13	6.56	39.31	2.63	6.56	3.0	16

M	N	P	Q	R	S
11.63	7.94	13.69	7.88	8.31	2.06
14	9.5	16.5	9.5	10	2.5
18.69	12.69	22	12.44	13.13	3.31

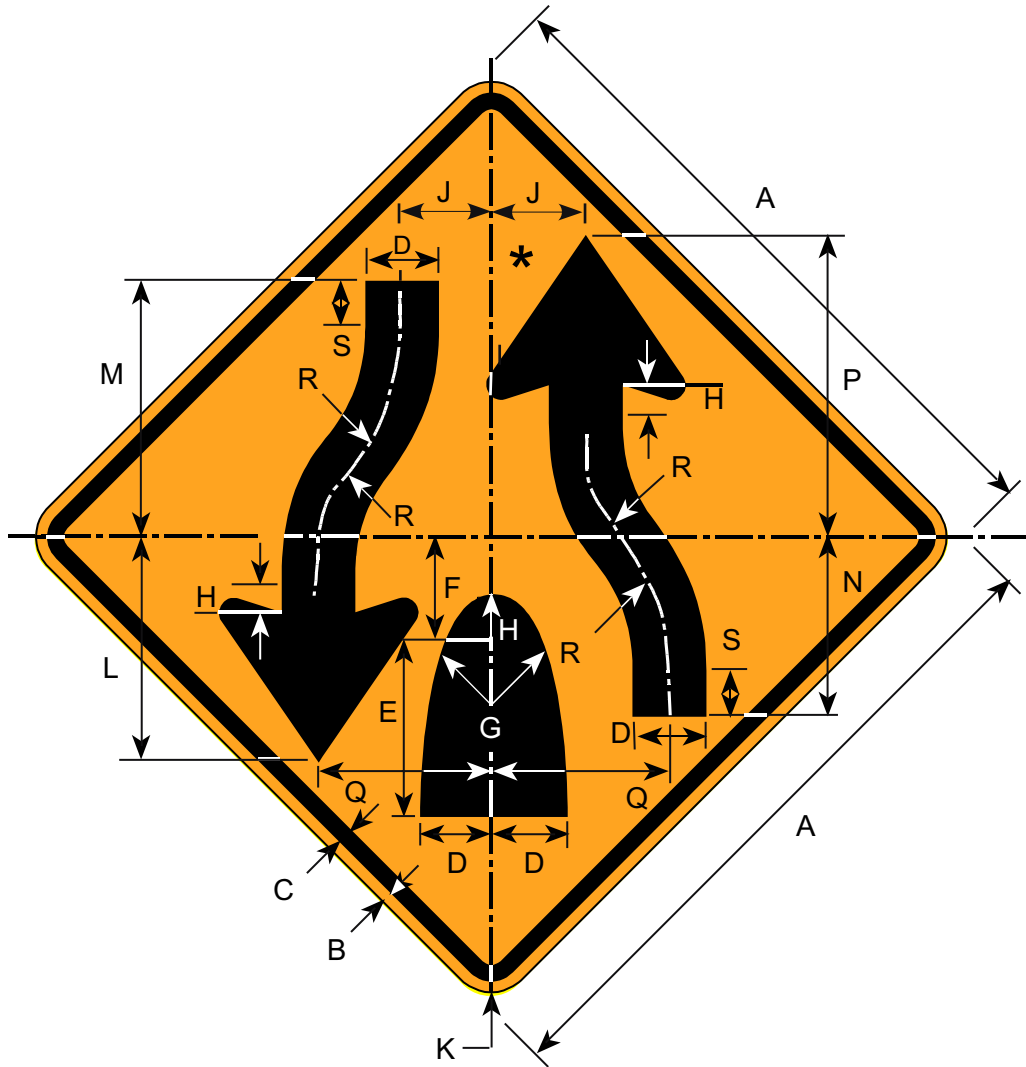

* See Appendix B-1 for Standard Arrow Details.

Border and Legend: Black
Background: Orange

Road Class	Dimensions (inches)										
	A	B	C	D	E	F	G	H	J	K	L
Minimum	30	0.50	0.75	3.31	8.31	4.13	25	1.69	4.13	1.88	10
Conventional	36	0.63	0.88	4.0	10	5.0	30	2.0	5.0	2.25	12
Expwy/Fwy	48	0.75	1.25	5.25	13.13	6.56	39.31	2.63	6.56	3.0	16

M	N	O	P	Q	R	S
11.63	7.94	7.88	13	7.88	8.31	2.06
14	9.50	9.5	16.5	9.5	10	2.5
18.69	12.69	12.69	22	12.44	13.13	3.31

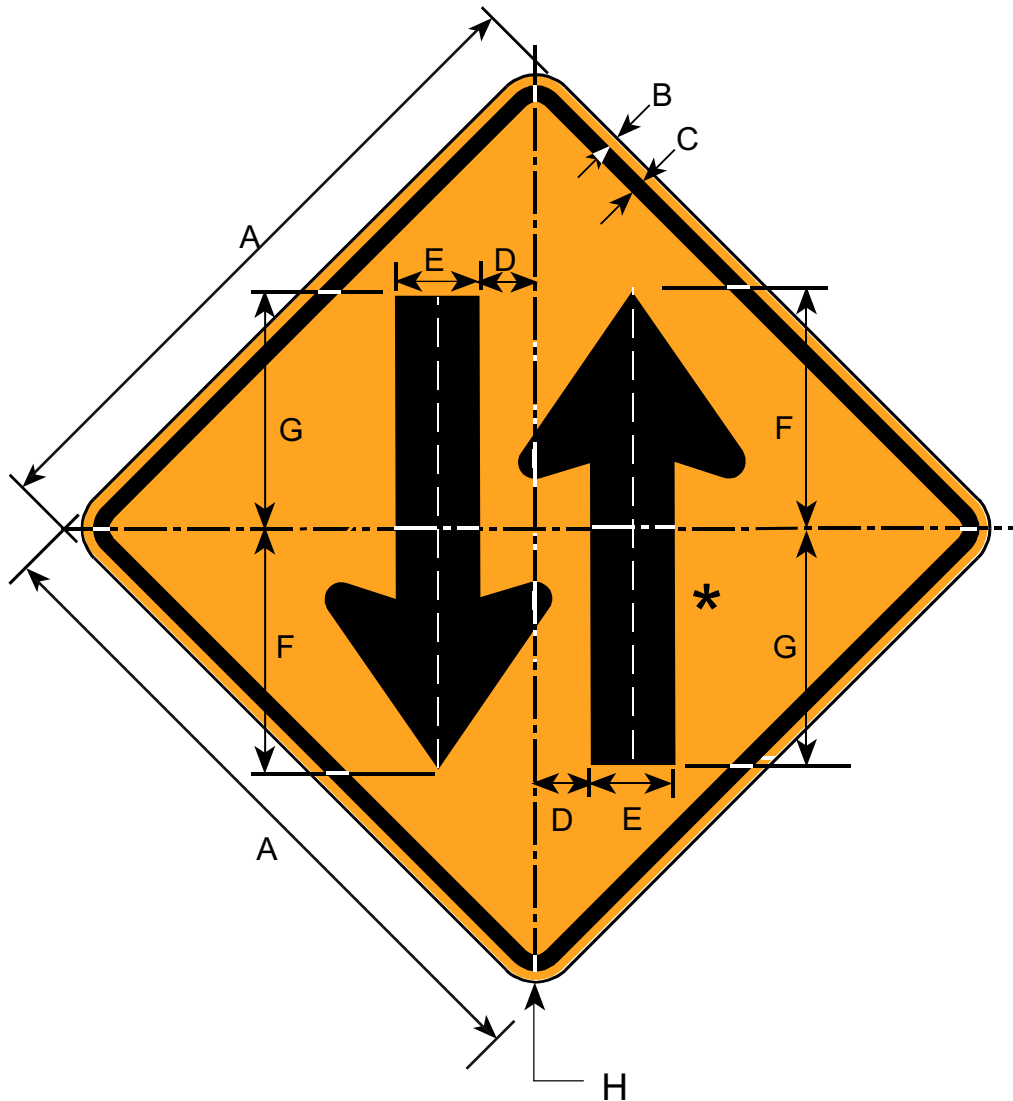

* See Appendix B-1 for Standard Arrow Details.

Border and Legend: Black
Background: Orange

Road Class	Dimensions (inches)							
	A	B	C	D	E	F	G	H
Minimum	30	0.50	0.75	2.44	3.75	11.25	10.63	1.88
Conventional	36	0.63	0.88	2.94	4.5	13.5	12.75	2.25
Expwy/Fwy	48	0.75	1.25	3.88	6.0	18	17	3.0

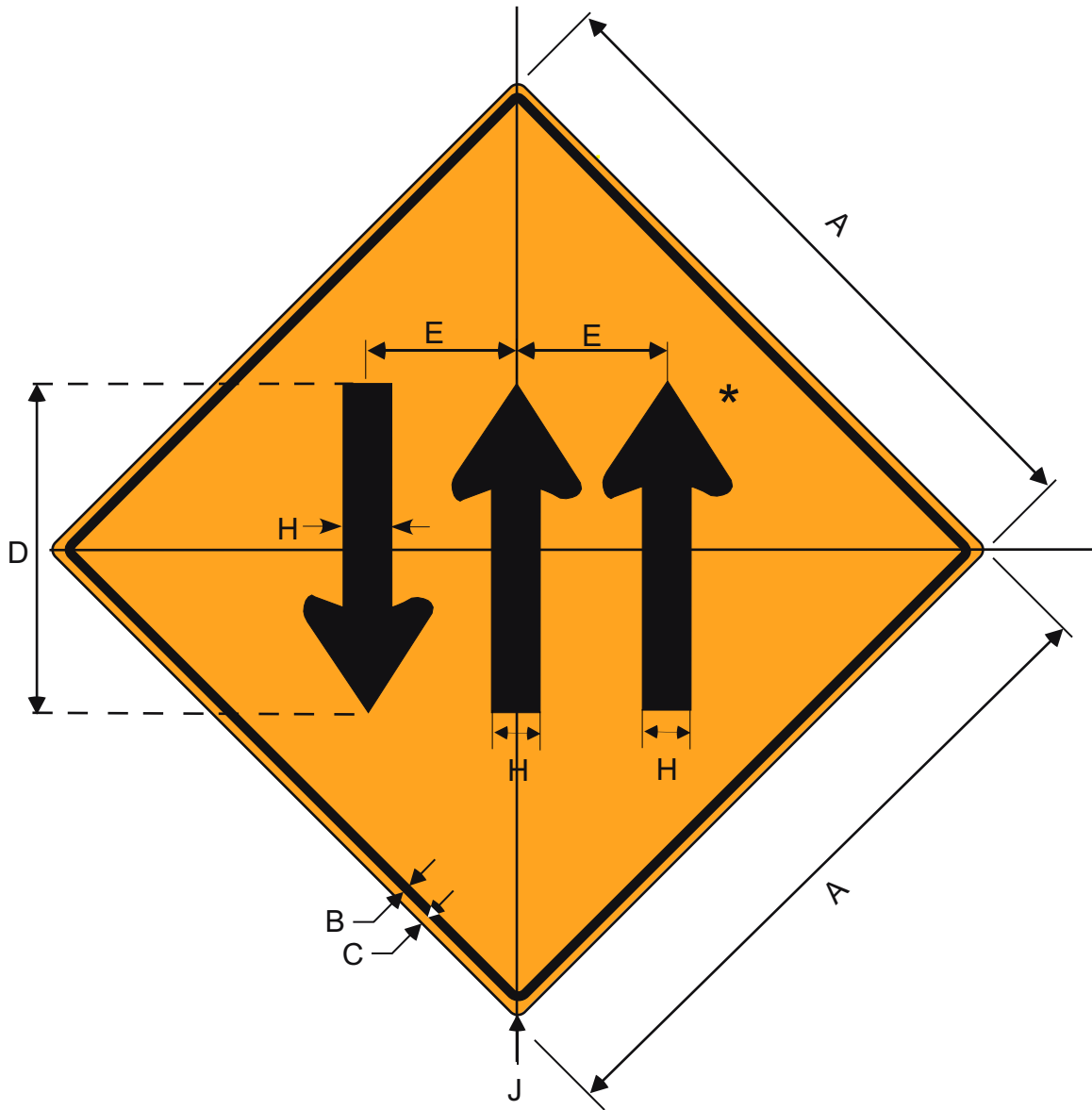

* See Appendix B-1 for Standard Arrow Details.

Border and Legend: Black
Background: Orange

Road Class	Dimensions (inches)									
	A	B	C	D	E	F	G	H	J	
Conventional	36	0.63	0.88	22	8.0	5.56	6.0	2.75	2.25	
Expwy/Fwy	48	0.75	1.25	30	11	7.13	8.0	3.5	3.0	

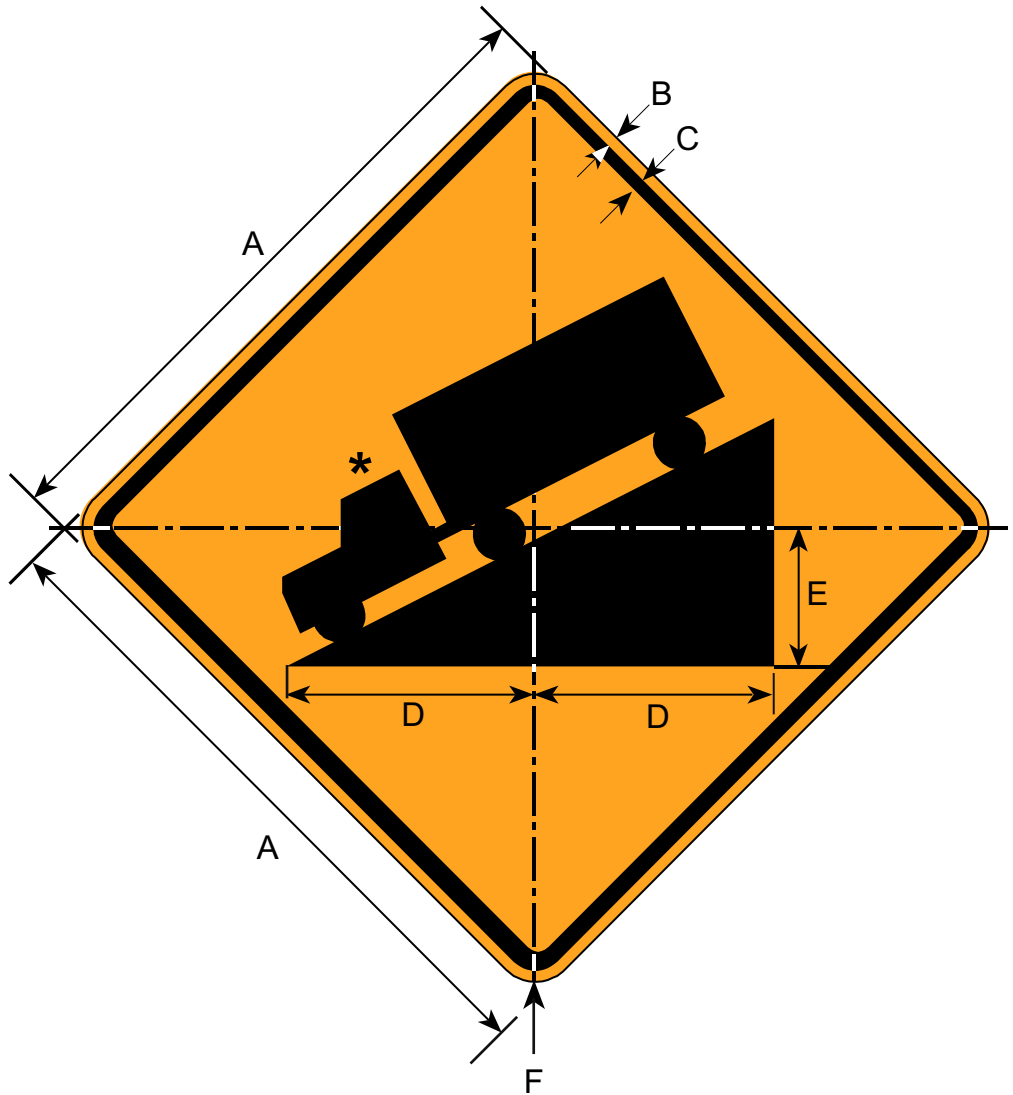

*Make symbol proportional to the graphic shown.

Border and Legend: Black
Background: Orange

Road Class	Dimensions (inches)					
	A	B	C	D	E	F
Minimum	30	0.50	0.75	11	7.50	1.88
Conventional	36	0.63	0.88	13.25	9.0	2.25
Expwy/Fwy	48	0.75	1.25	17.5	12	3.0

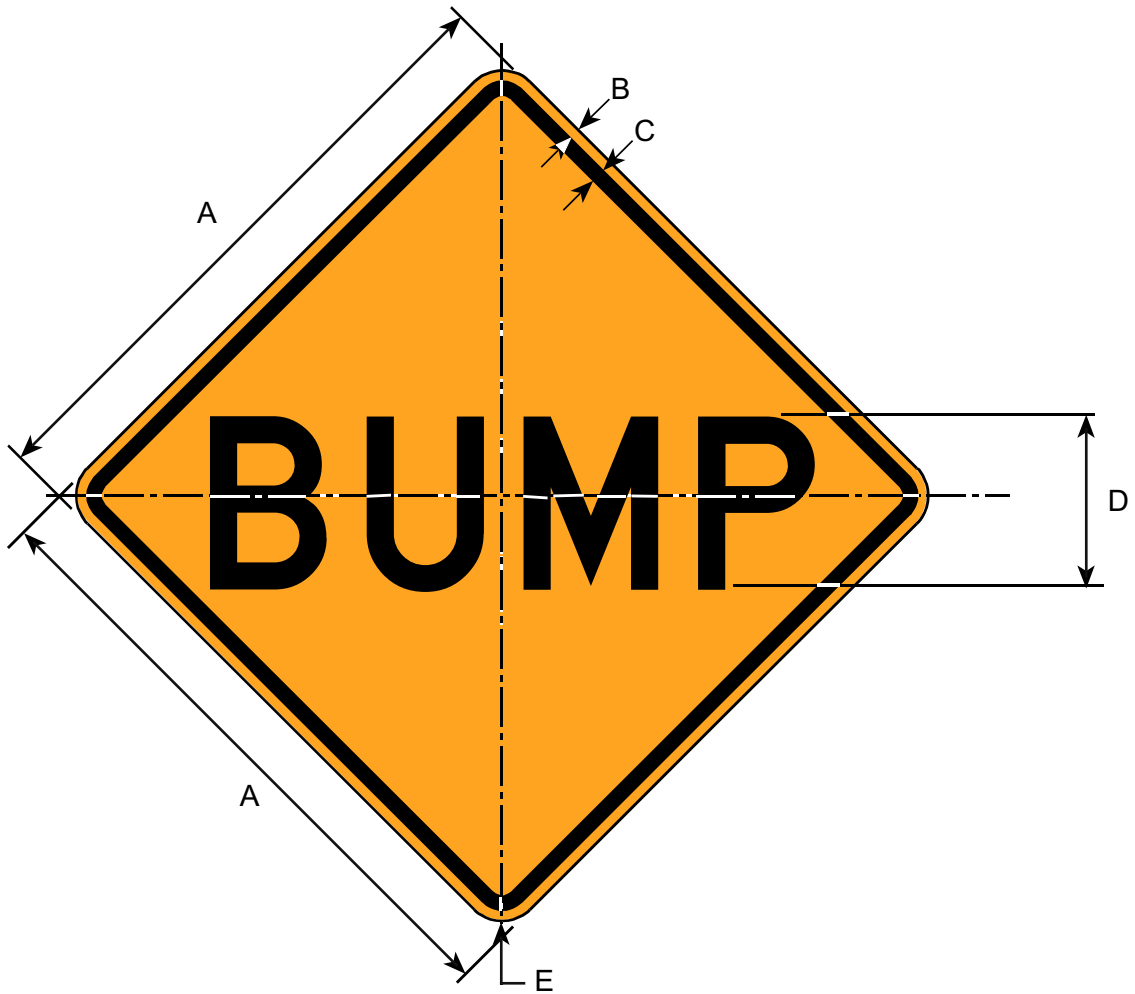

Border and Legend: Black
 Background: Orange

Road Class	Dimensions (inches)				
	A	B	C	D	E
Minimum	30	0.50	0.75	8D	1.88
Conventional	36	0.63	0.88	10D	2.25
Expwy/Fwy	48	0.75	1.25	12D	3.0

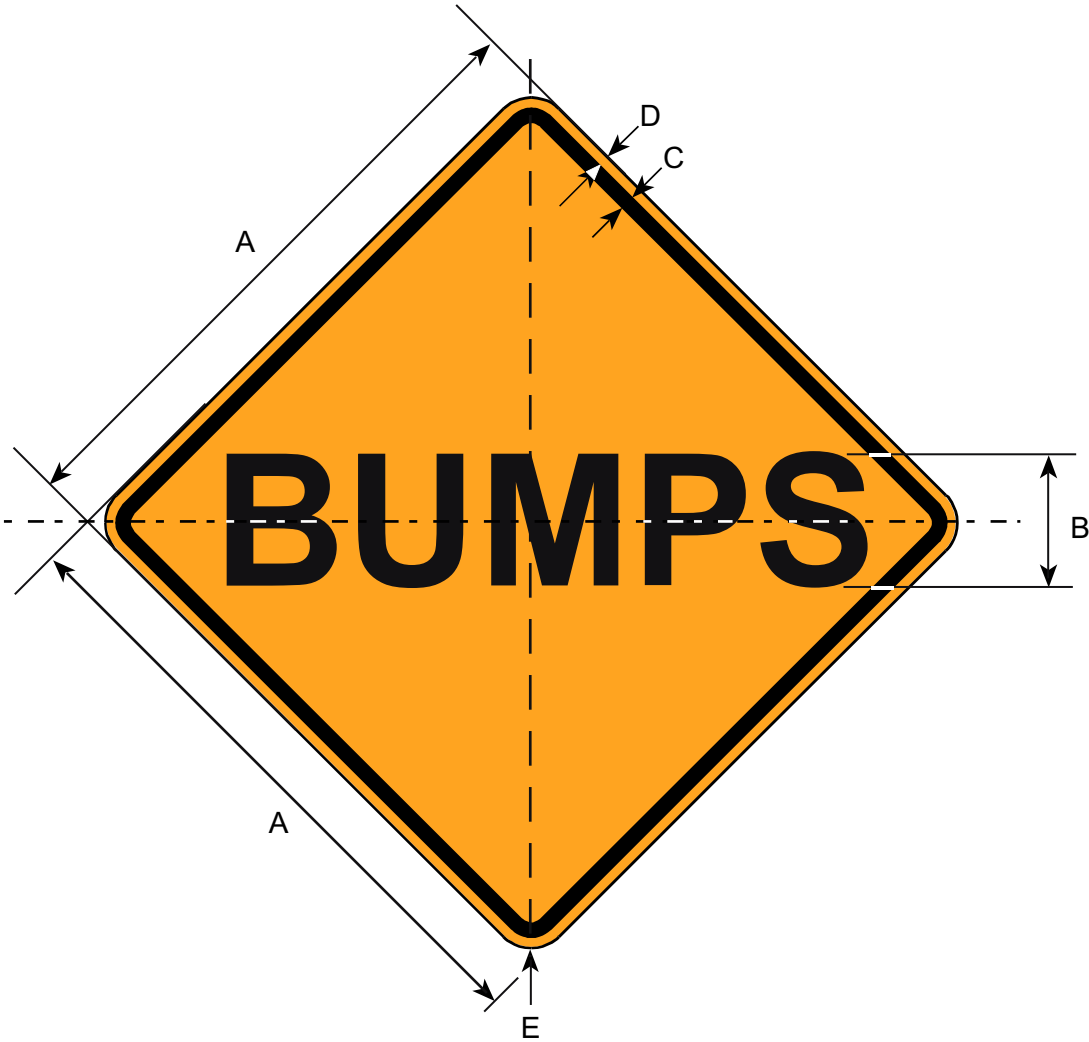

Border and Legend: Black
Background: Orange

Road Class	Dimensions (inches)				
	A	B	C	D	E
Minimum	30	6D	0.75	1.25	1.88
Conventional	36	8D	0.88	1.50	2.25
Expwy/Fwy	48	10D	1.25	2.0	3.0

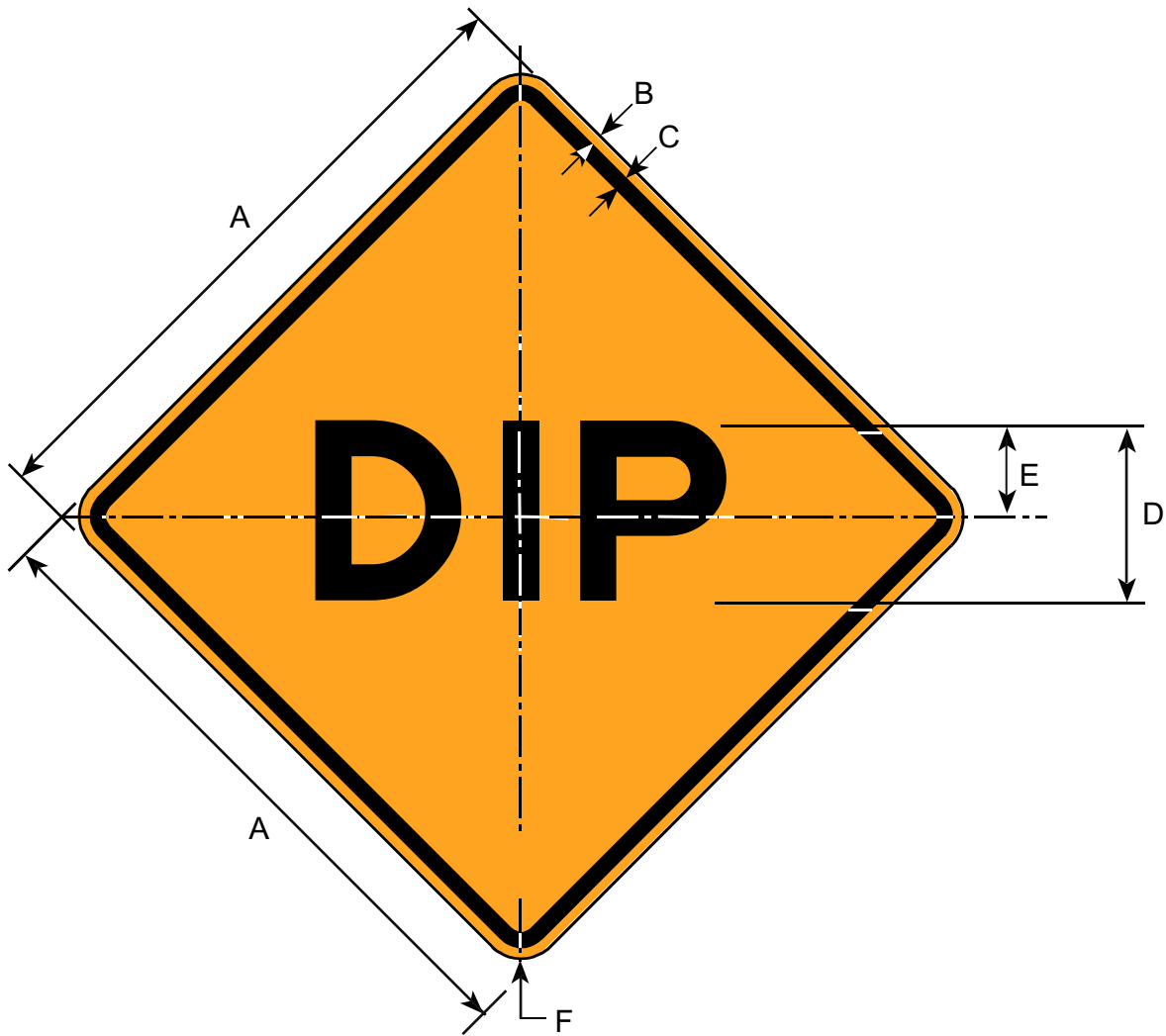

Border and Legend: Black
Background: Orange

Road Class	Dimensions (inches)					
	A	B	C	D	E	F
Minimum	30	0.50	0.75	8E	4.0	1.88
Conventional	36	0.63	0.88	10E	5.0	2.25
Expwy/Fwy	48	0.75	1.25	12E	6.0	3.0

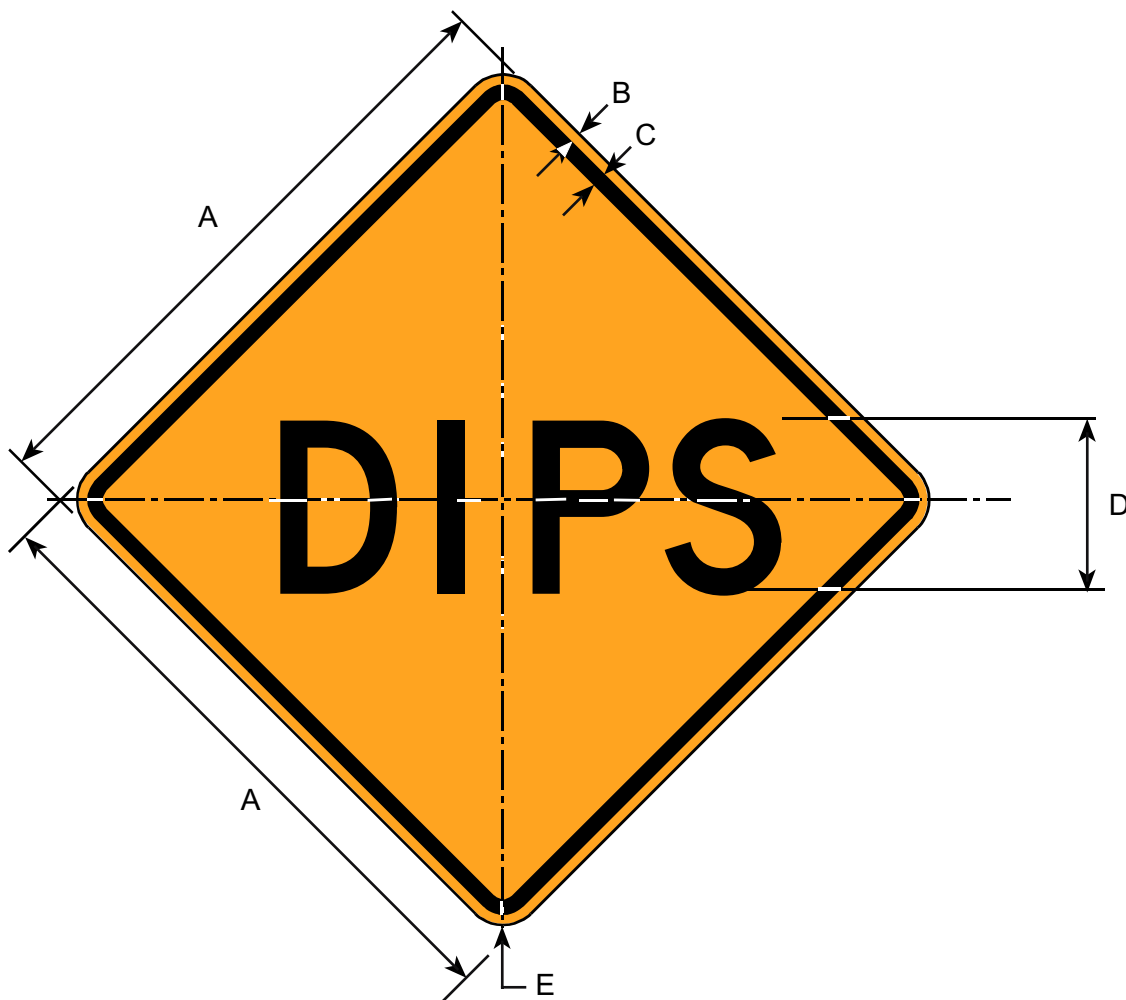

Border and Legend: Black
Background: Orange

Road Class	Dimensions (inches)				
	A	B	C	D	E
Minimum	30	0.50	0.75	7E	1.88
Conventional	36	0.63	0.88	8E	2.25
Expwy/Fwy	48	0.75	1.25	10E	3.00

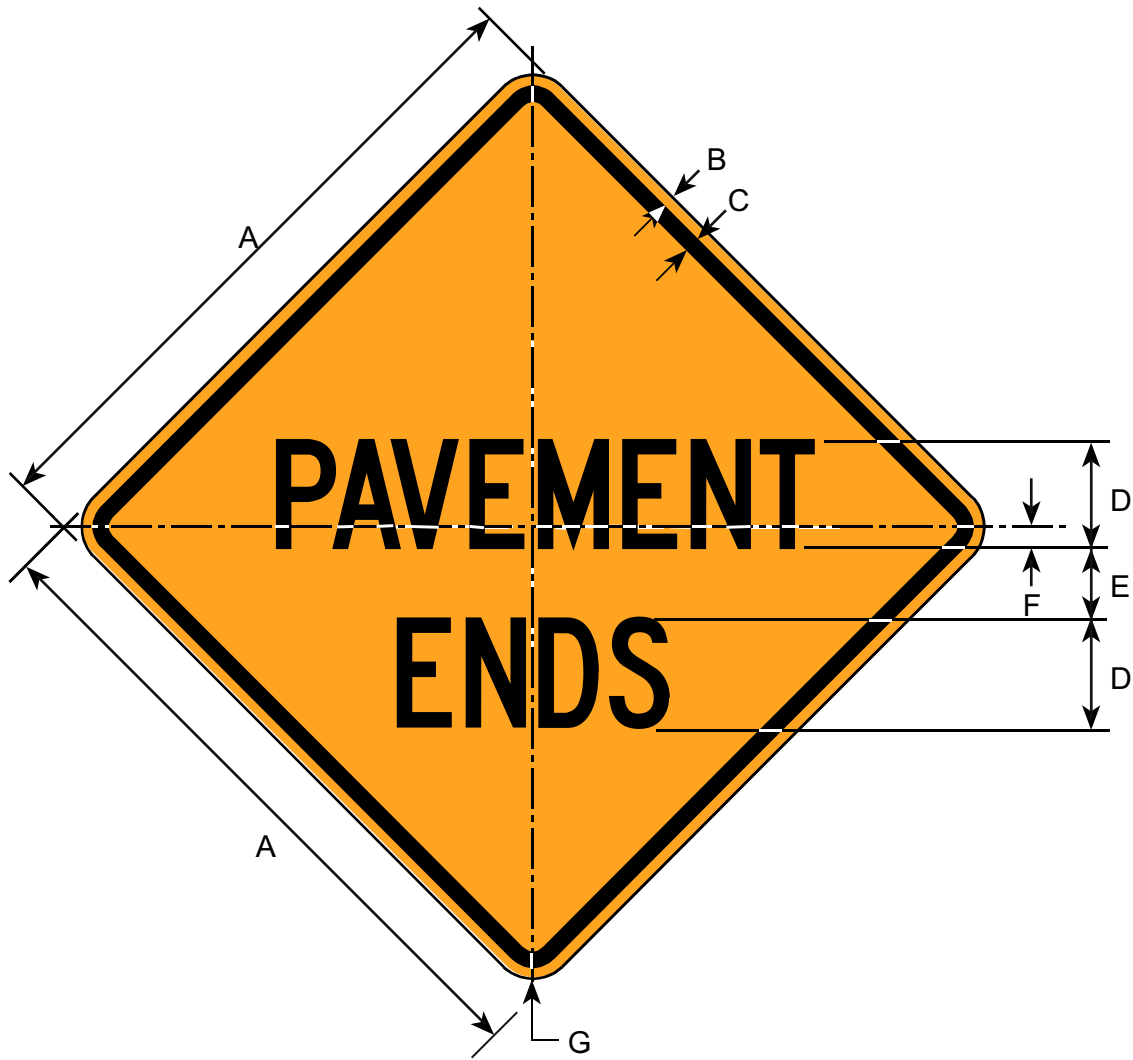

Border and Legend: Black
Background: Orange

Road Class	Dimensions (inches)						
	A	B	C	D	E	F	G
Minimum	30	0.50	0.75	5C	3.0	0.75	1.88
Conventional	36	0.63	0.88	6C	3.5	1.00	2.25
Expwy/Fwy	48	0.75	1.25	8C	4.5	1.50	3.00

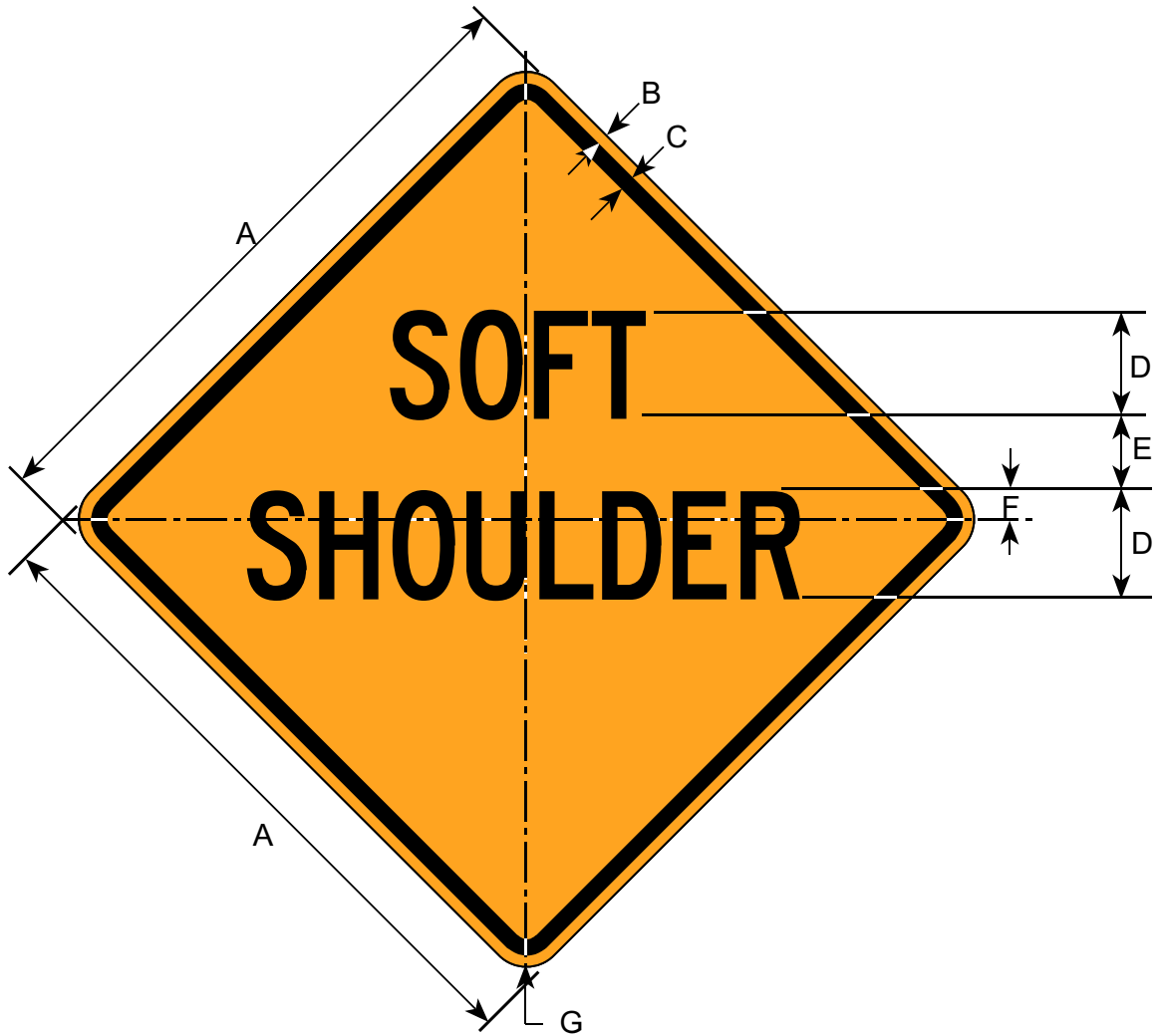

Border and Legend: Black
Background: Orange

Road Class	Dimensions (inches)						
	A	B	C	D	E	F	G
Minimum	30	0.50	0.75	5C	3.0	0.75	1.88
Conventional	36	0.63	0.88	6C	3.5	1.00	2.25
Expwy/Fwy	48	0.75	1.25	8C	5.0	1.25	3.00

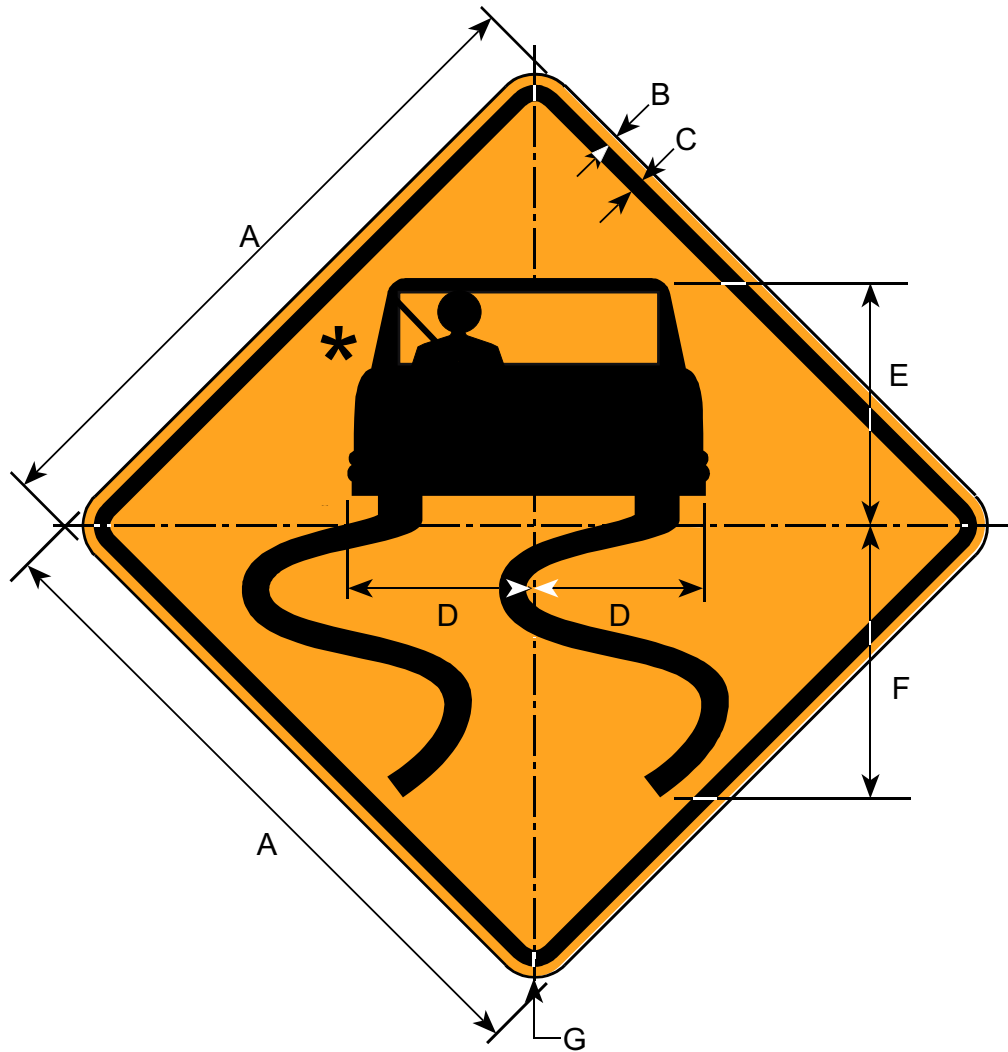

*Make symbol proportional to the graphic shown.

Border and Legend: Black
Background: Orange

Sign shall only be used with CW8-5P Slippery When Wet (Plate)

Road Class	Dimensions (inches)						
	A	B	C	D	E	F	G
Minimum	30	0.50	0.75	8	11	12.50	1.88
Conventional	36	0.63	0.88	9.50	13	14.81	2.25
Expwy/Fwy	48	0.75	1.25	12.63	17.33	19.75	3

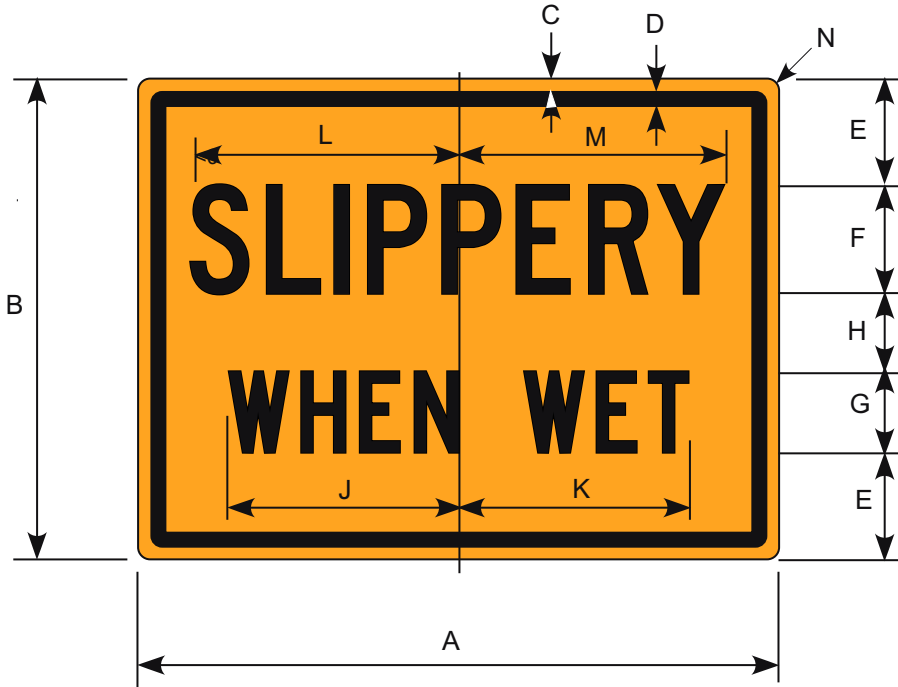

Border and Legend: Black
 Background: Orange

Plate shall only be used with CW8-5 Slippery When Wet

Road Class	Dimensions (inches)													
	A	B	C	D	E	F	G	H	J	K	L	M	N	
Conventional	24	18	0.38	0.63	4	4C	3C	3	8.69	8.63	9.88	10	1.5	

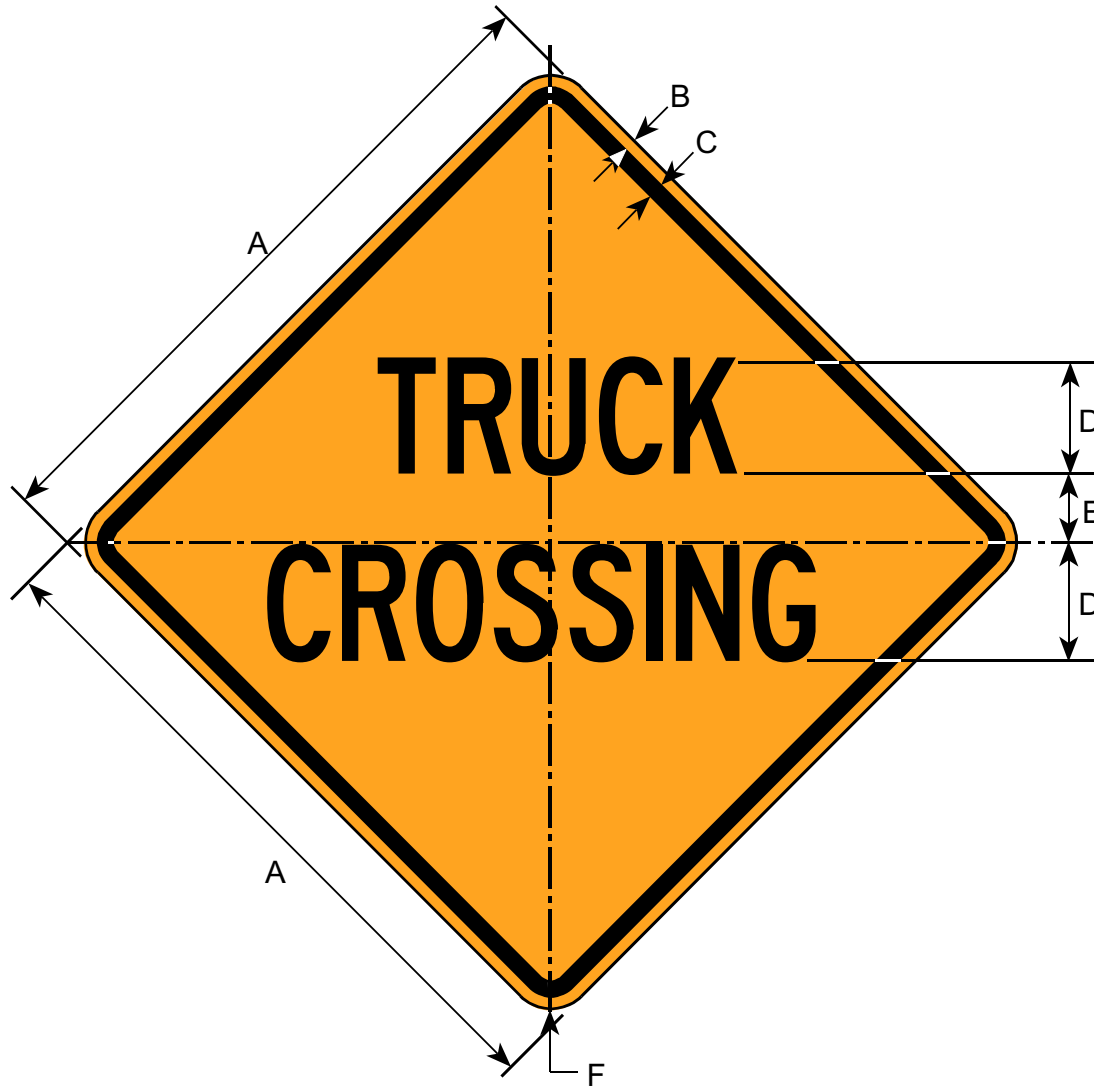

Border and Legend: Black
Background: Orange

Road Class	Dimensions (inches)					
	A	B	C	D	E	F
Minimum	30	0.50	0.75	5C	3.0	1.88
Conventional	36	0.63	0.88	6C	3.5	2.25
Expwy/Fwy	48	0.75	1.25	8C	5.0	3.00

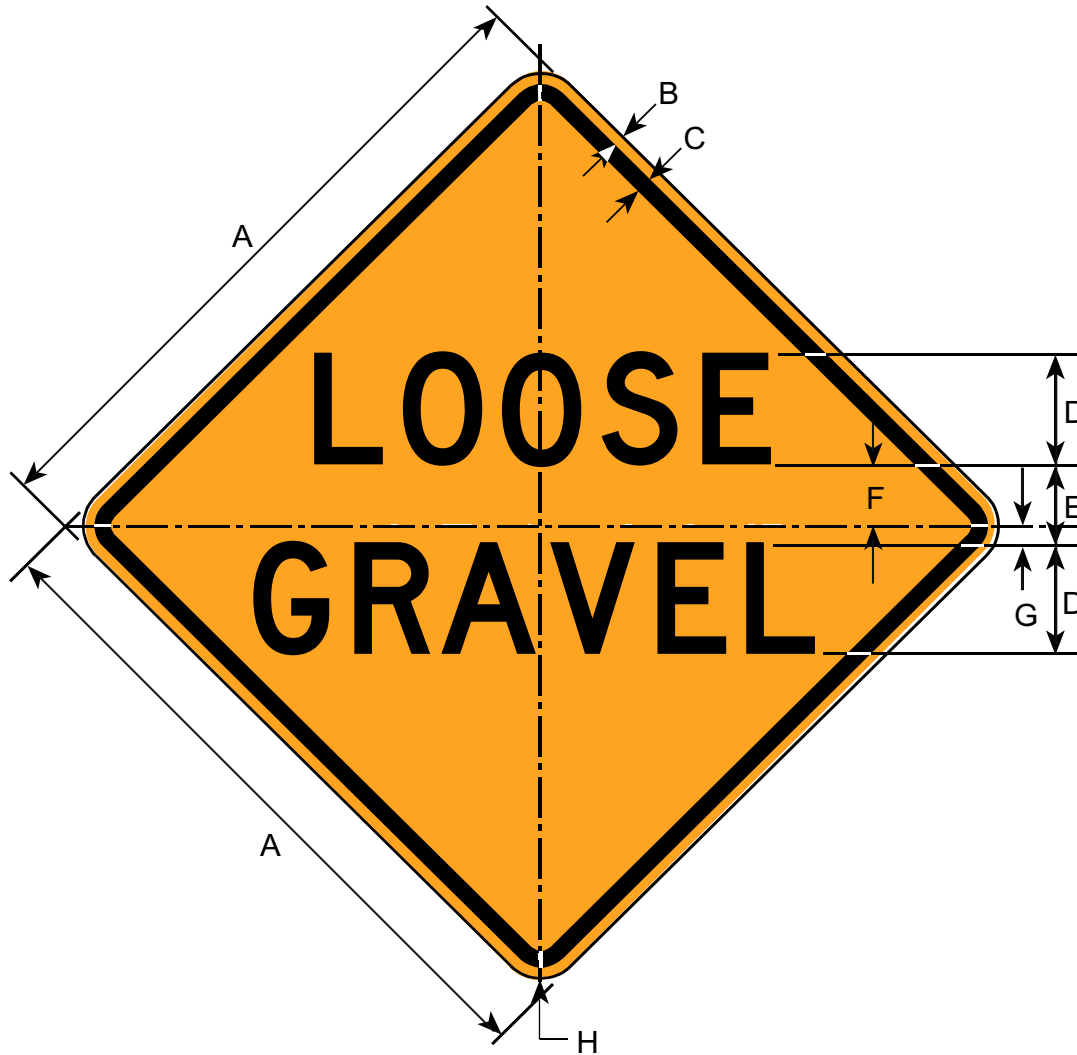

Border and Legend: Black
Background: Orange

Road Class	Dimensions (inches)							
	A	B	C	D	E	F	G	H
Minimum	30	0.50	0.75	5D	3.44	2.81	0.63	1.88
Conventional	36	0.63	0.88	6D	4.13	3.38	0.75	2.25
Expwy/Fwy	48	0.75	1.25	8D	5.50	4.50	1.00	3.00

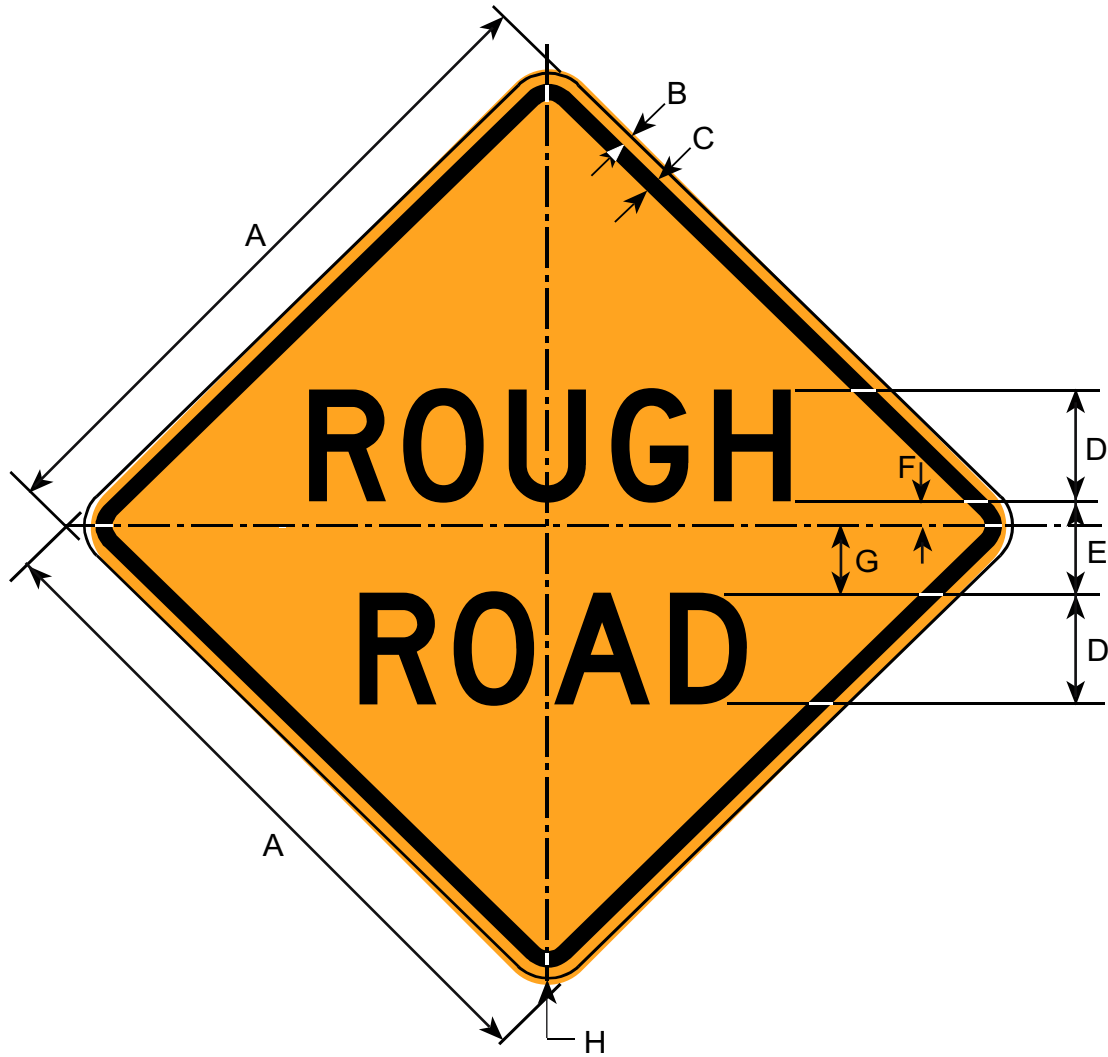

Border and Legend: Black
Background: Orange

Road Class	Dimensions (inches)							
	A	B	C	D	E	F	G	H
Minimum	30	0.50	0.75	5D	4	0.87	3.13	1.88
Conventional	36	0.63	0.88	6D	5	1.00	4.00	2.25
Expwy/Fwy	48	0.75	1.25	8D	6	1.50	4.50	3.00

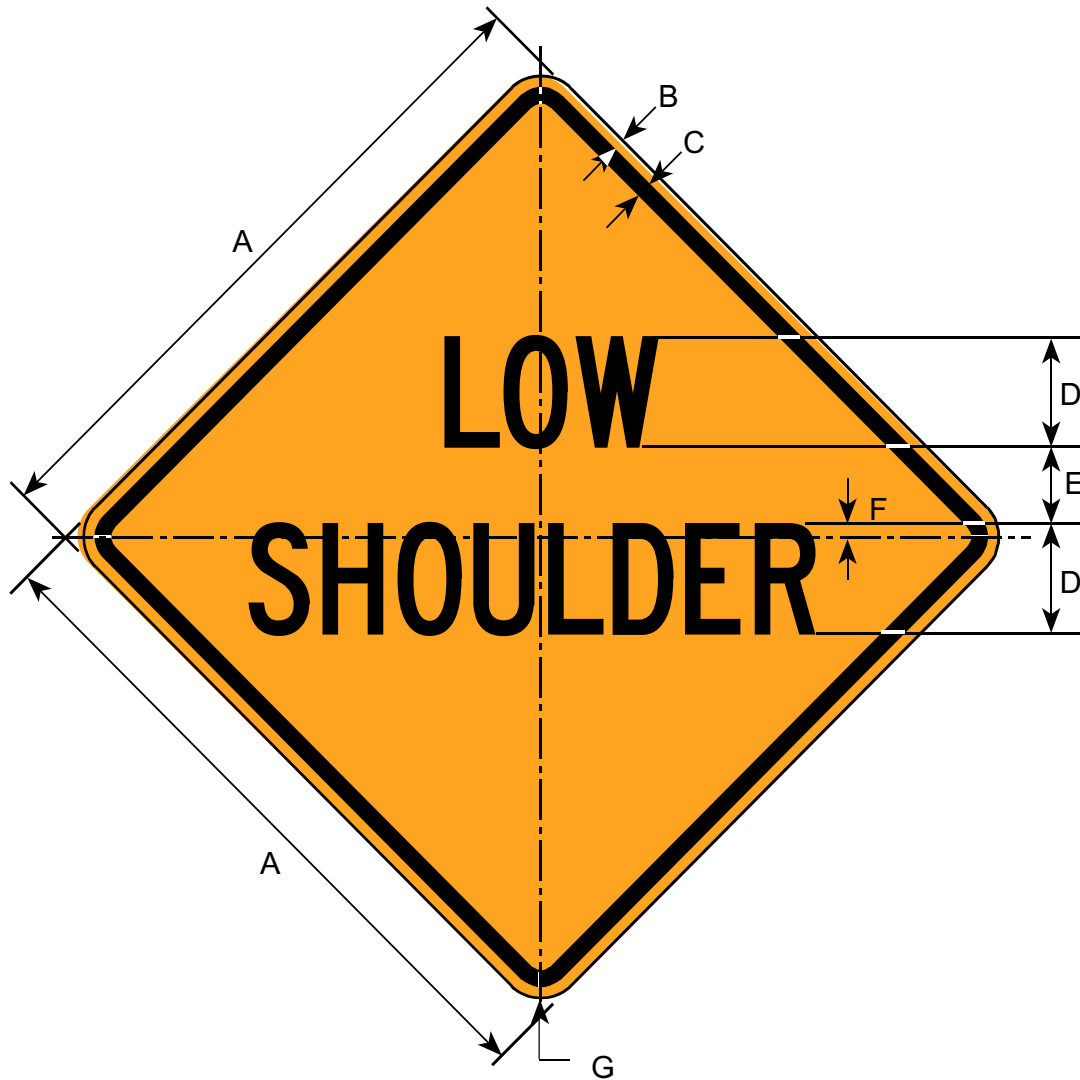

Border and Legend: Black
Background: Orange

Road Class	Dimensions (inches)						
	A	B	C	D	E	F	G
Minimum	30	0.50	0.75	5C	3.0	0.75	1.88
Conventional	36	0.63	0.88	6C	3.5	1.00	1.25
Expwy/Fwy	48	0.75	1.25	8C	5.0	1.25	3.00

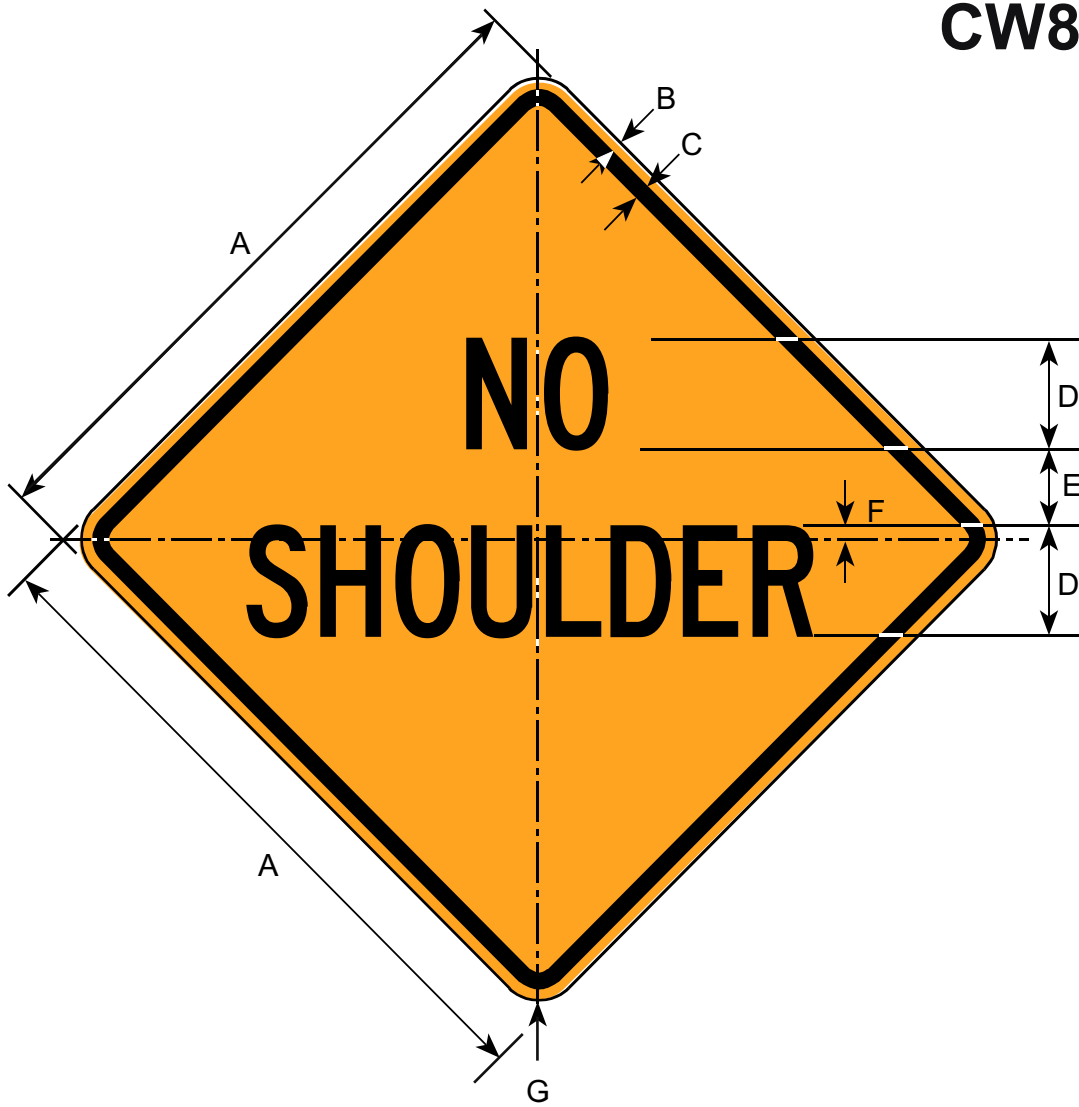

Border and Legend: Black
Background: Orange

Prior to the 2002 publication of this manual, this sign was numbered CW8-10.

Road Class	Dimensions (inches)						
	A	B	C	D	E	F	G
Minimum	30	0.50	0.75	5C	3.0	0.75	1.88
Conventional	36	0.63	0.88	6C	3.5	1.00	1.25
Expy/Fwy	48	0.75	1.25	8C	5.0	1.25	3.00

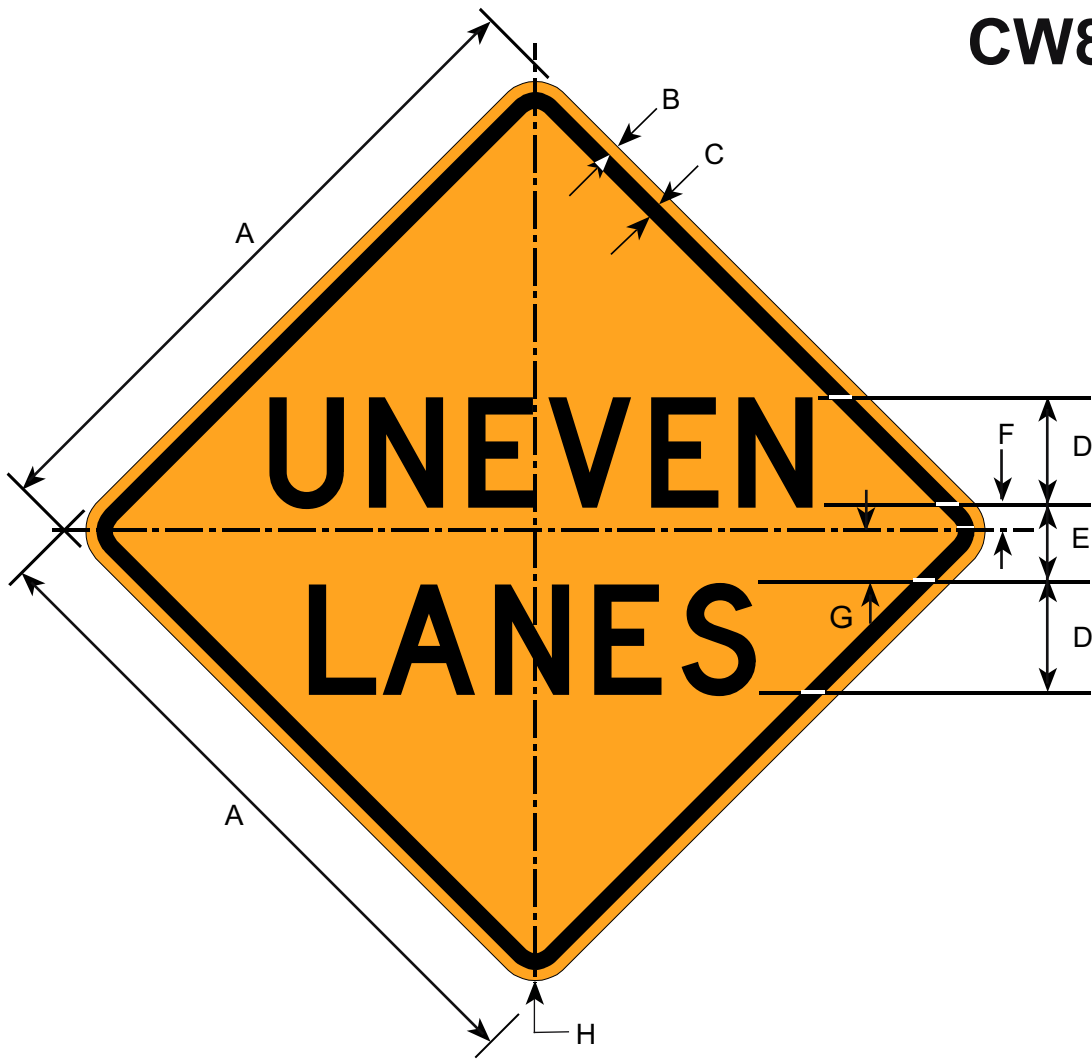

Border and Legend: Black
 Background: Orange

Road Class	Dimensions (inches)							
	A	B	C	D	E	F	G	H
Conv & Min	36	0.63	0.88	6D	4.5	1.0	3.5	1.5
Expwy/Fwy	48	0.75	1.25	7D	6.0	1.5	4.5	2.0

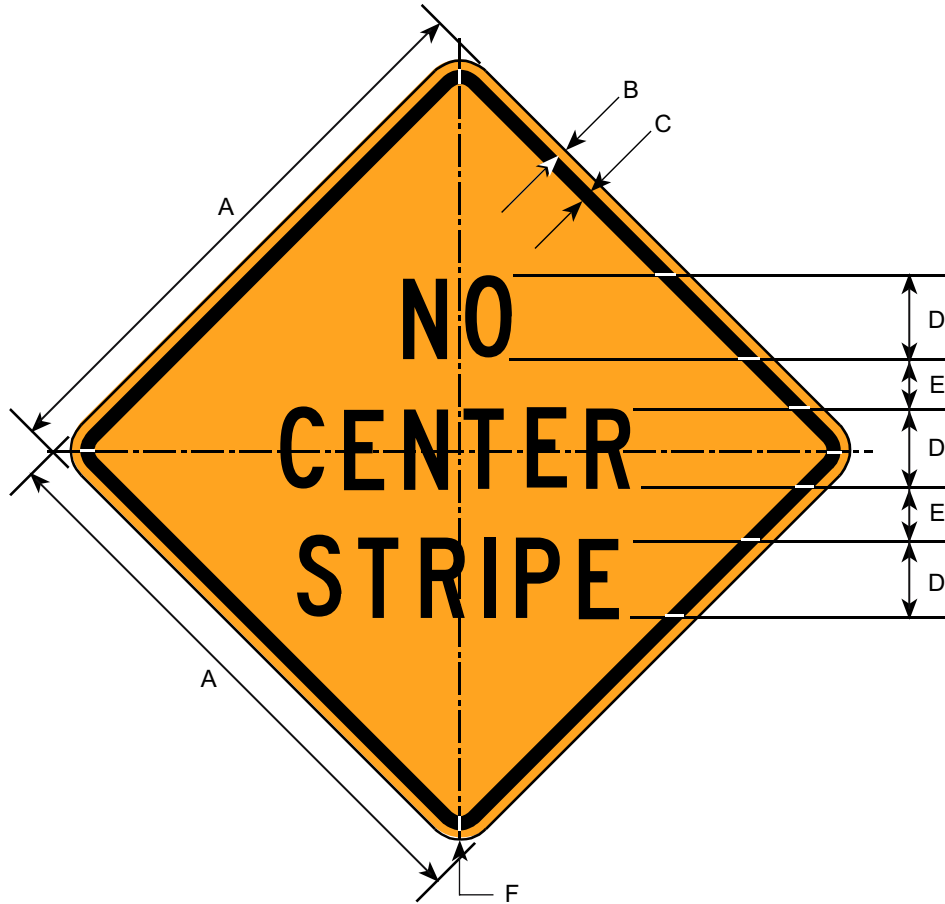

Border and Legend: Black
Background: Orange

Road Class	Dimensions (inches)					
	A	B	C	D	E	F
Minimum	30	0.50	0.75	4C	2.50	1.88
Conventional	36	0.63	0.88	5C	3.25	2.25
Expwy/Fwy	48	0.75	1.25	7C	4.50	3.00

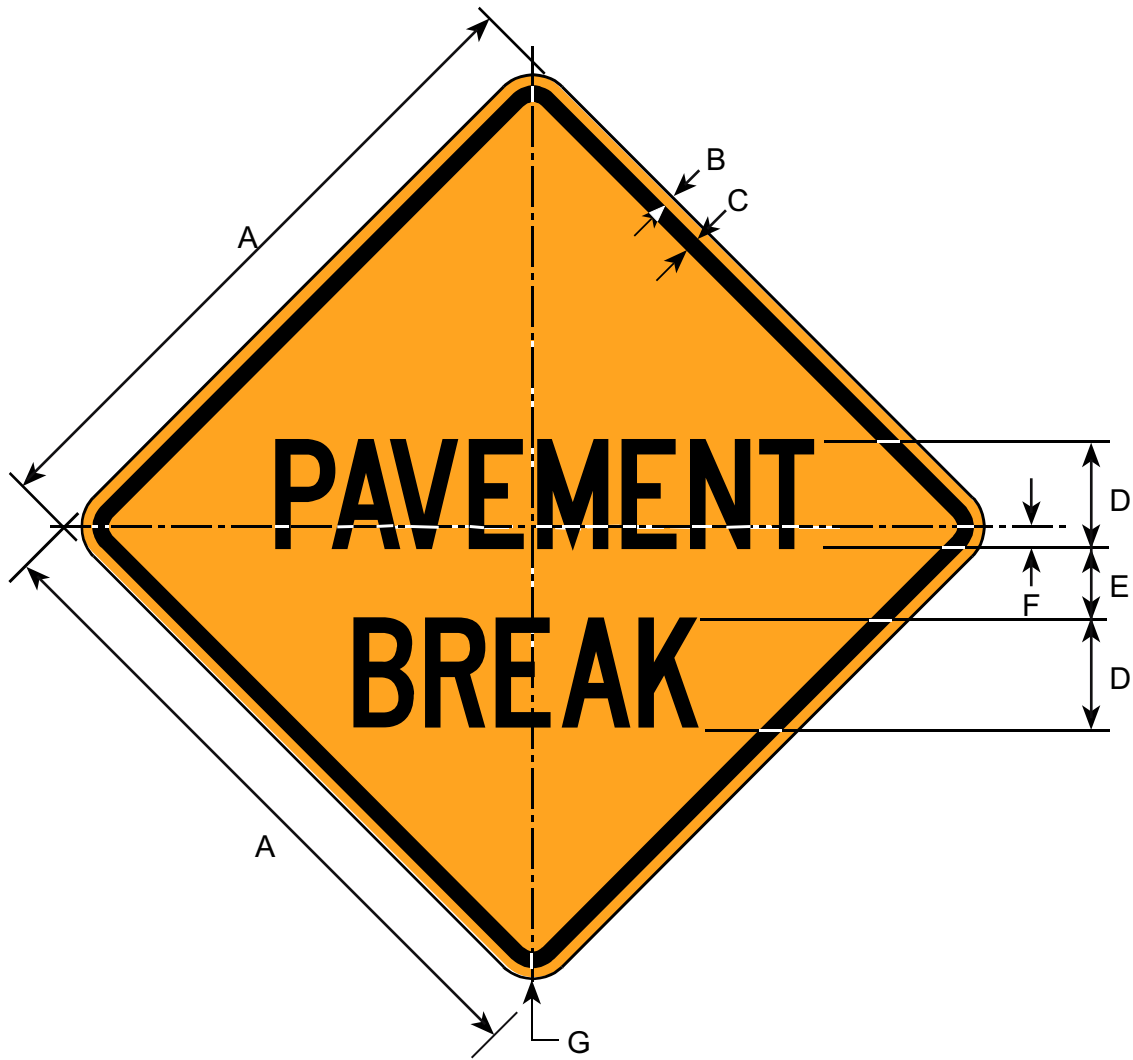

Border and Legend: Black
Background: Orange

Road Class	Dimensions (inches)						
	A	B	C	D	E	F	G
Minimum	30	0.50	0.75	5C	3.0	0.75	1.88
Conventional	36	0.63	0.88	6C	3.5	1.00	2.25
Expwy/Fwy	48	0.75	1.25	8C	4.5	1.50	3.00

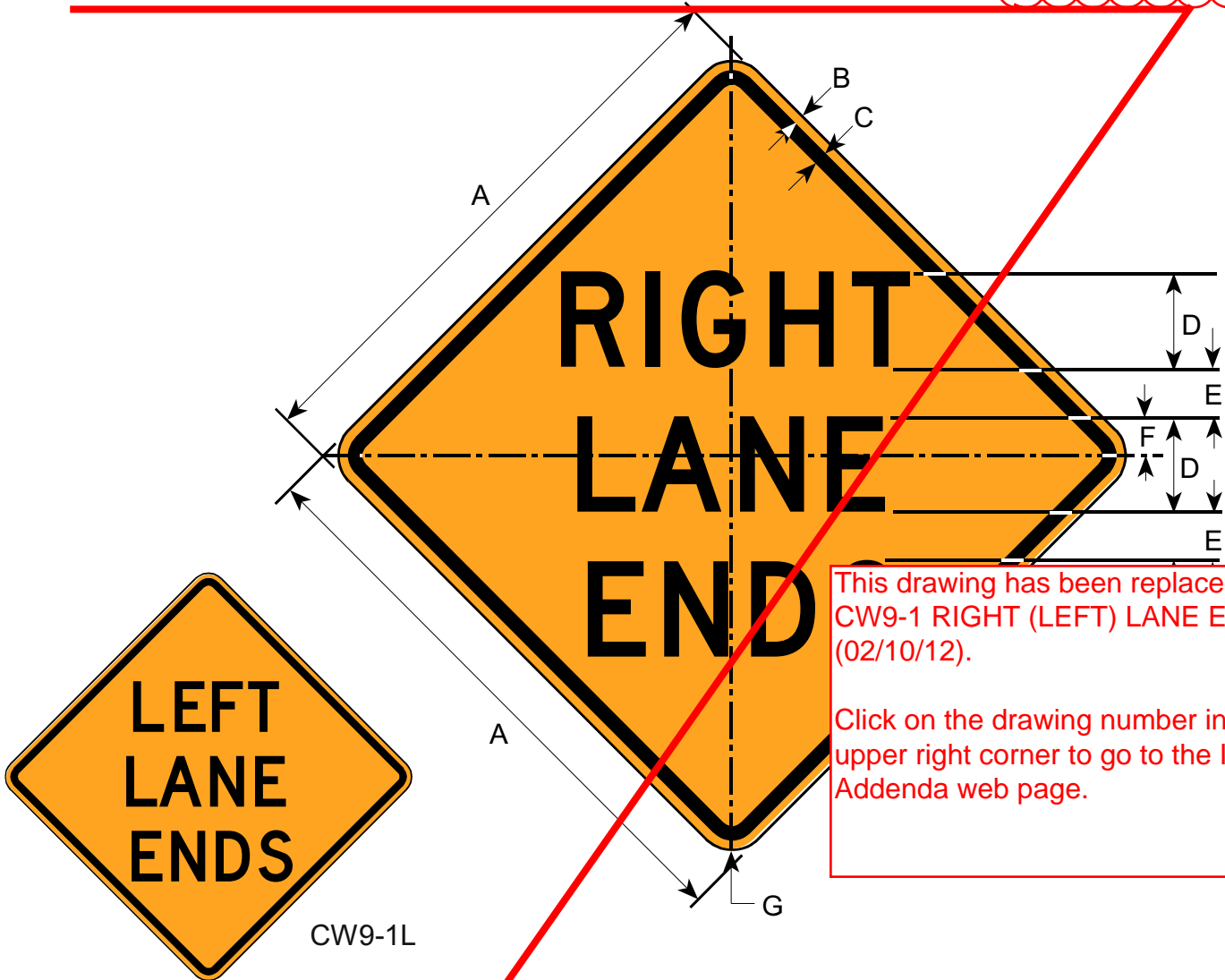

This drawing has been replaced with:
CW9-1 RIGHT (LEFT) LANE ENDS
 (02/10/12).

Click on the drawing number in the
 upper right corner to go to the Interim
 Addenda web page.

Border and Legend: Black
 Background: Orange

Road Class	Dimensions (inches)						
	A	B	C	D	E	F	G
Minimum	36	0.63	0.88	6D	3.0	2.0	2.25
Conventional	48	0.75	1.25	8D	4.0	3.0	3.0
Exp/Fwy	60	1.0	1.5	10D	5.0	0.5	3.75

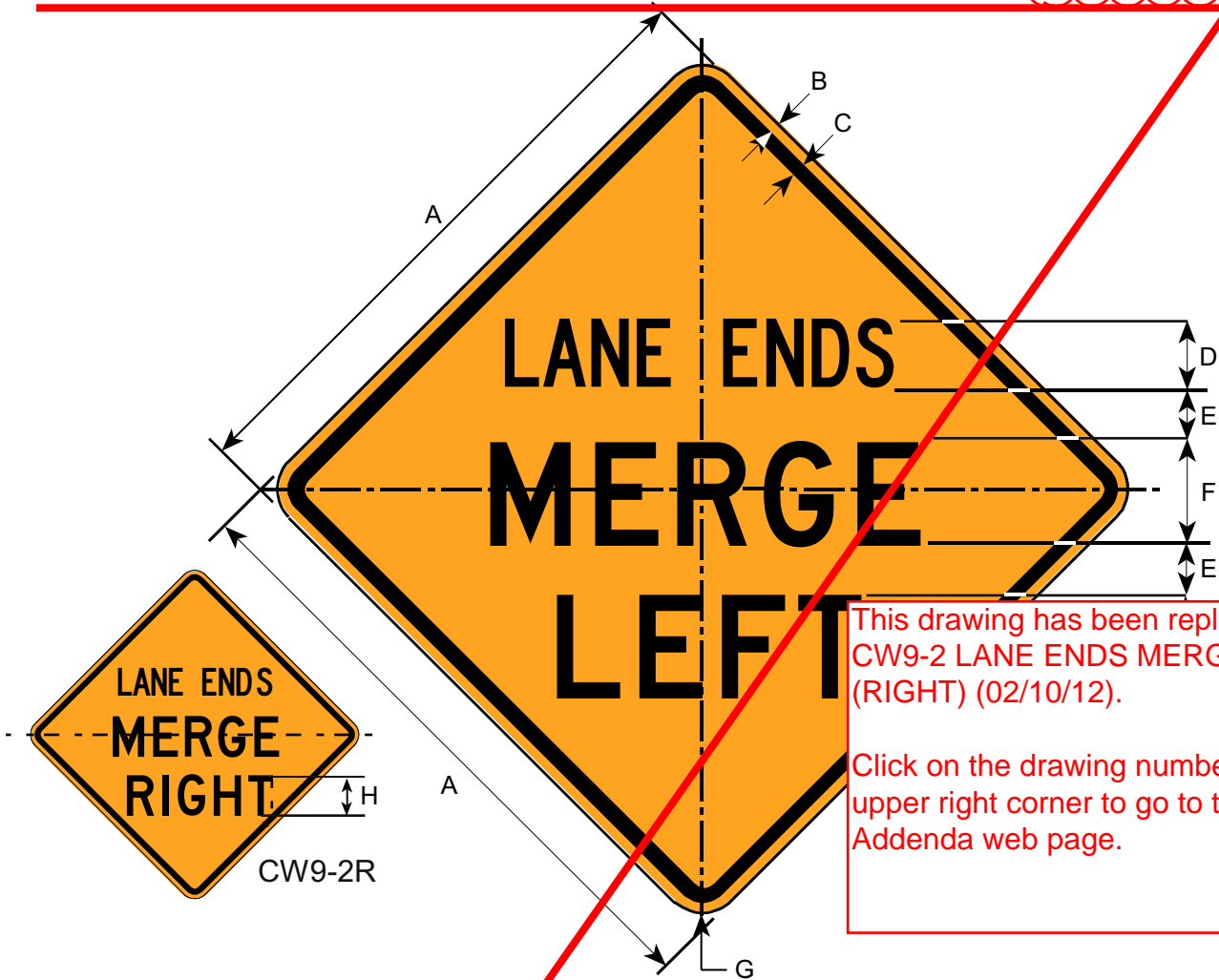

This drawing has been replaced with:
 CW9-2 LANE ENDS MERGE LEFT
 (RIGHT) (02/10/12).

Click on the drawing number in the
 upper right corner to go to the Interim
 Addenda web page.

Border and Legend: Black
 Background: Orange

Road Class	Dimensions (inches)							
	A	B	C	D	E	F	G	H
Minimum	36	0.63	0.88	4D	3.0	6D	2.25	6D
Conventional	48	0.75	1.25	6D	4.0	8D	3.0	8D
Expwy/Fwy	60	1.0	1.5	7D	5.0	10D	3.75	10D

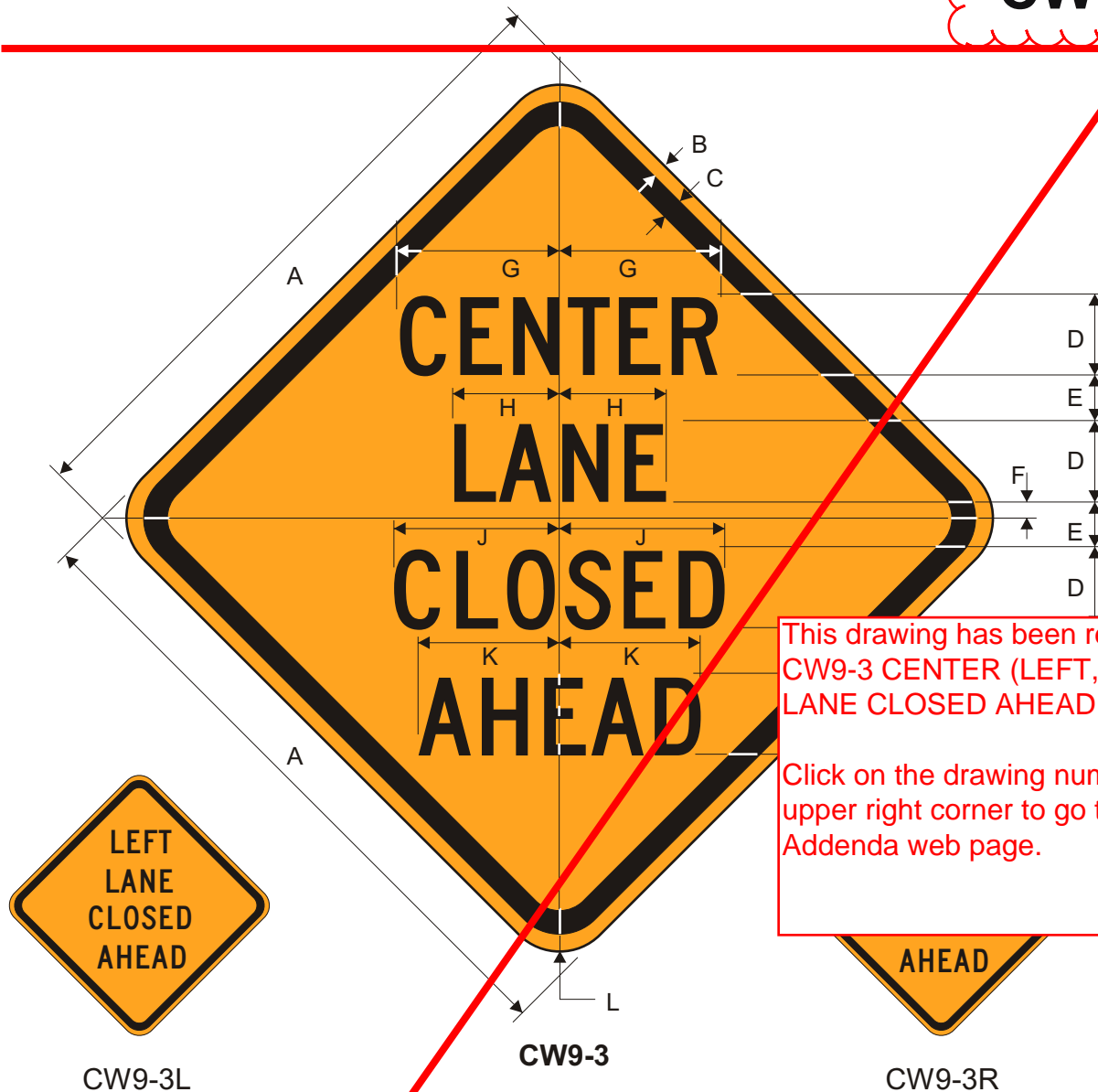

This drawing has been replaced with: CW9-3 CENTER (LEFT, RIGHT) LANE CLOSED AHEAD (02/10/12).

Click on the drawing number in the upper right corner to go to the Interim Addenda web page.

Border and Legend: Black
Background: Orange

Road Class	Dimensions (inches)										
	A	B	C	D	E	F	G	H	J	K	L
Minimum	30	0.5	0.75	4C	2.24	0.88	8.0	5.3	8.17	6.99	1.88
Conventional	36	0.63	0.88	5C	2.0	0.68	10	6.6	10.21	8.73	2.25
Expy/Fwy	48	0.75	1.25	6C	4.52	1.08	12.05	7.89	12.25	10.47	3.0
Oversized	60	0.75	1.25	8C	5.2	1.64	16.05	10.51	16.33	13.95	3.0



Border and Legend: Black
Background: Orange

Road Class	Dimensions (inches)										
	A	B	C	D	E	F	G	H	J	K	L
Conventional	72	48	0.75	1.25	6	5D	5	4	8D	5C	3



Border and Legend: Black
Background: Orange

Road Class	Dimensions (inches)										
	A	B	C	D	E	F	G	H	J	K	L
Conventional	66	48	0.75	1.25	6	5D	5	4	8D	5C	3

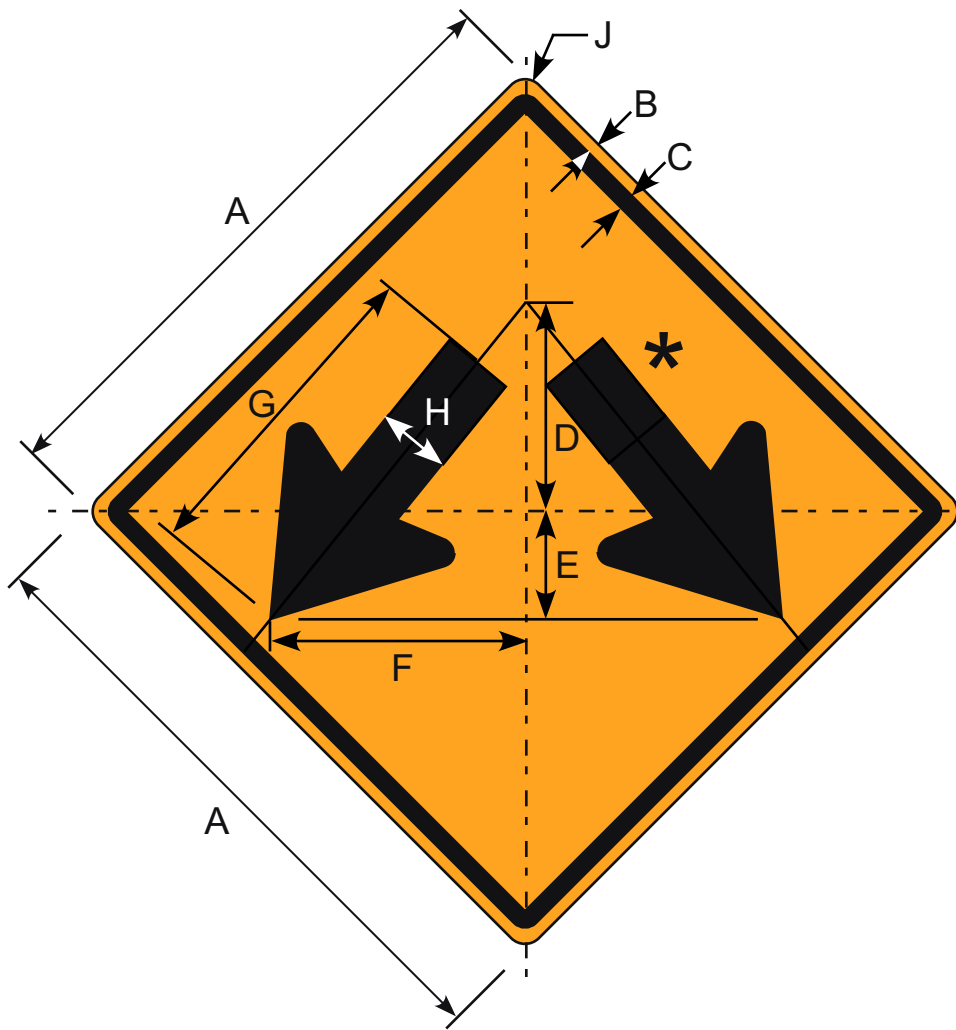

Border and Legend: Black
Background: Orange

* See Appendix B-1 for
Standard Arrow Detail

Road Class	Dimensions (inches)								
	A	B	C	D	E	F	G	H	J
Minimum	30	0.50	0.75	10	5.25	12.38	14.69	4.0	1.88
Conventional	36	0.63	0.88	12	6.13	14.63	17.5	4.75	2.25
Expwy/Fwy	48	0.75	1.25	16	8.4	19.8	25.5	5.5	3.0

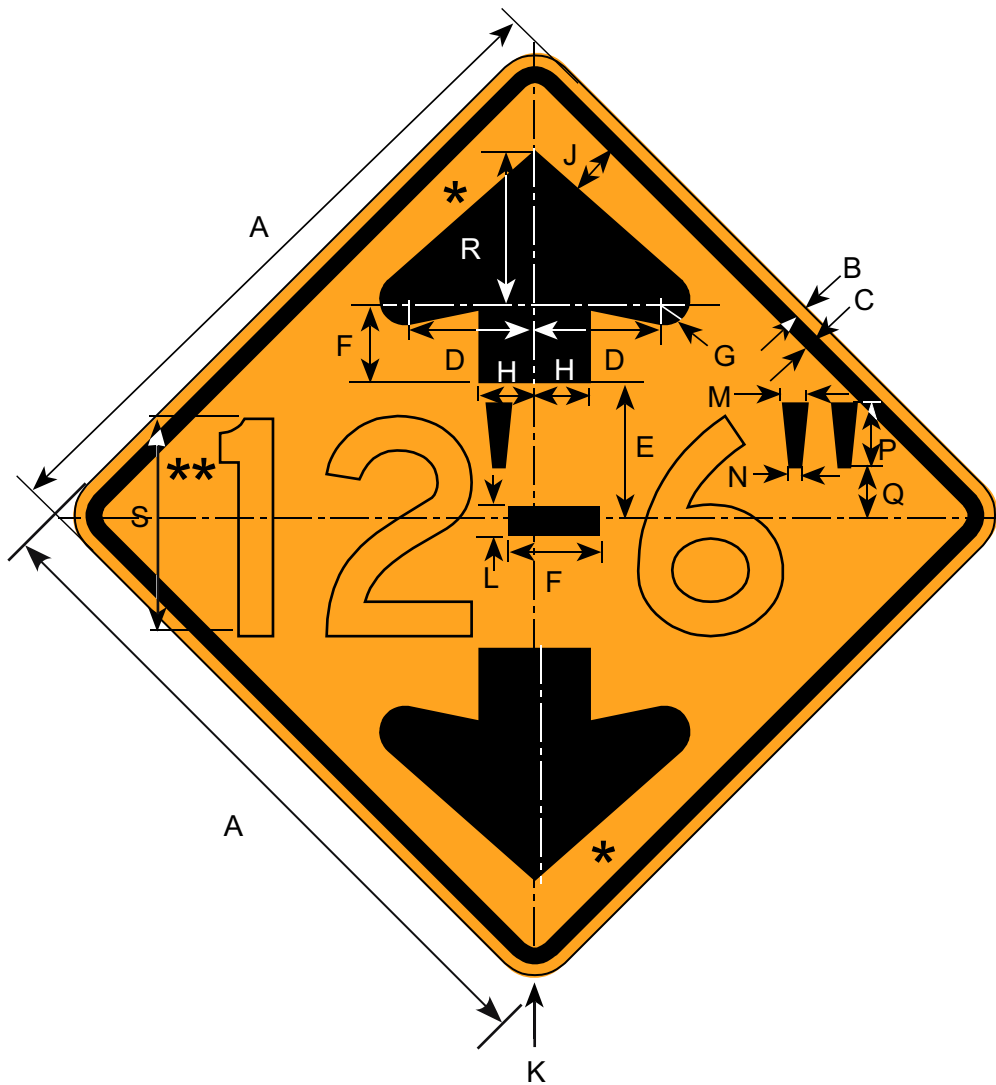

Border and Legend: Black
Background: Orange

**If clearance height does not fit reduce letter series or height as necessary.

* See Appendix B-1 for Standard Arrow Details.

Road Class	Dimensions (inches)										
	A	B	C	D	E	F	G	H	J	K	L
Minimum	30	0.50	0.75	5.75	6.63	3.75	0.75	2.5	1.69	1.88	1.56
Conventional	36	0.63	0.88	6.88	8.0	4.5	1.0	3.0	2.0	2.25	1.88
Expwy/Fwy	48	0.75	1.25	9.19	10.63	5.88	1.31	4.0	2.63	3.0	2.44

M	N	P	Q	S
1.0	0.44	2.25	3.31	10D
1.25	0.50	2.75	4.0	12D
1.63	0.63	3.63	5.5	16D

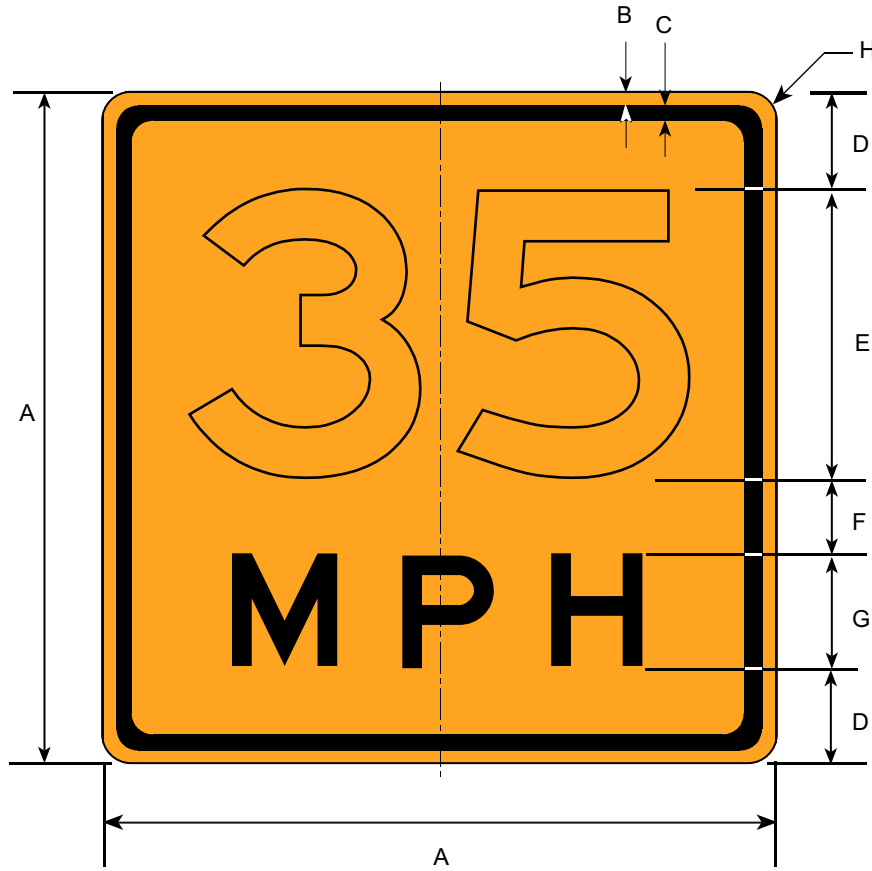
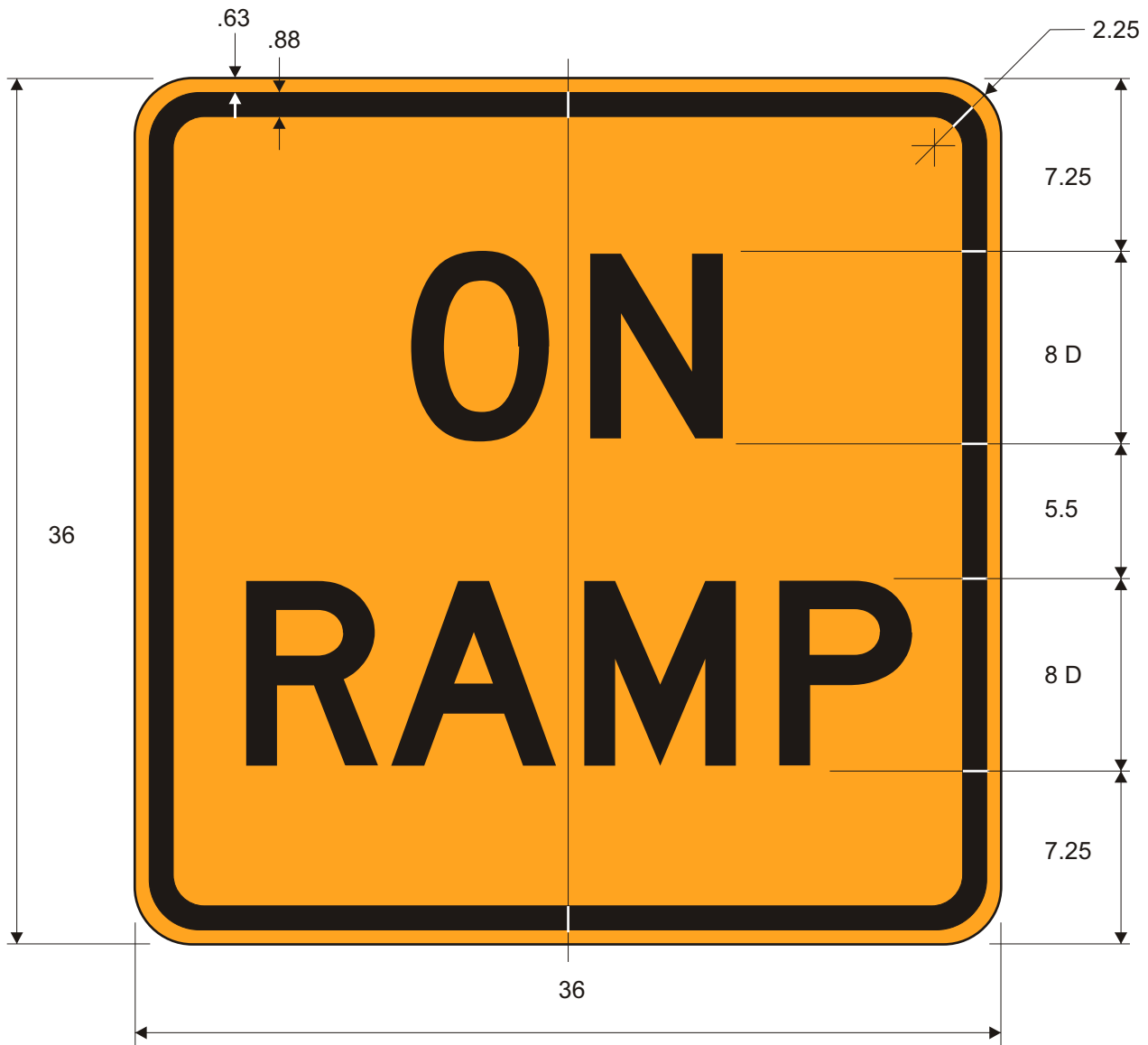

Plate shall not be used alone.

Border and Legend: Black
Background: Orange

Road Class	Dimensions (inches)							
	A	B	C	D	E	F	G	H
Minimum	18	0.38	0.63	2.5	8E	2.00	3E	1.5
Conventional	24	0.38	0.63	3.5	10E	2.75	4E	1.5
Expwy/Fwy	36	0.75	0.88	4.5	15E	3.50	6E	2.5



Border and Legend: Black
Background: Orange

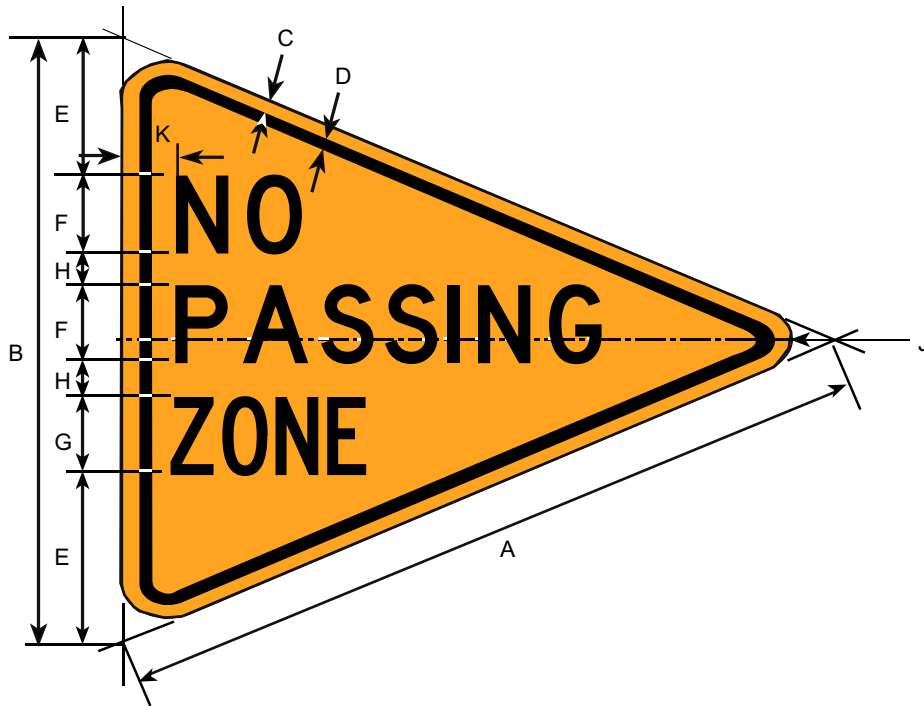

Border and Legend: Black
 Background: Orange

Road Class	Dimensions (inches)									
	A	B	C	D	E	F	G	H	J	K
Minimum	40	30	0.50	0.75	7.25	4D	4C	1.75	1.88	2.5
Conventional	48	36	0.63	0.88	8.5	5D	5C	2.0	2.25	3.0
Oversized	64	48	0.75	1.25	12	6D	6C	3.0	3.0	4.0

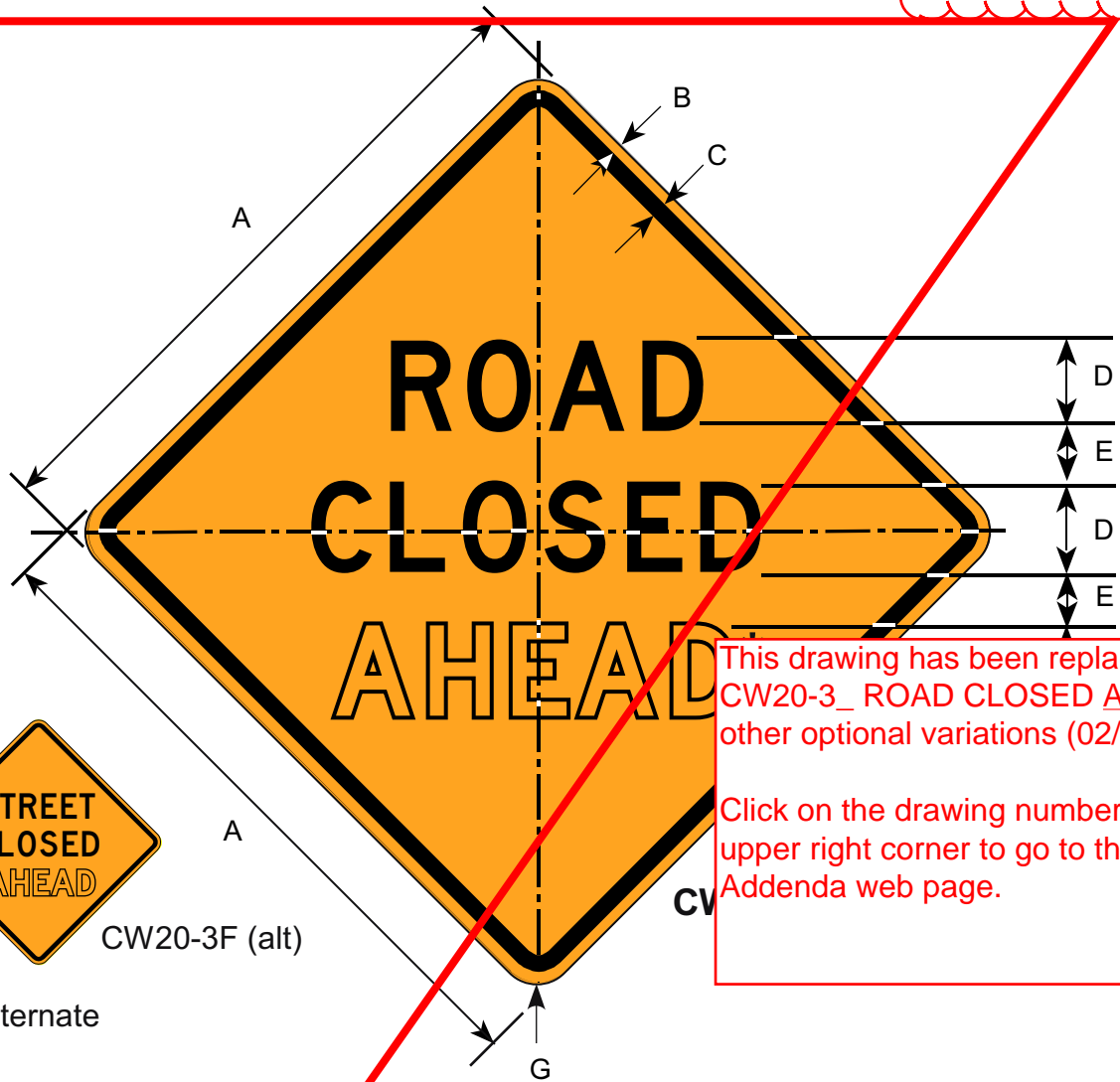

This drawing has been replaced with: CW20-3_ ROAD CLOSED AHEAD or other optional variations (02/10/12).
 Click on the drawing number in the upper right corner to go to the Interim Addenda web page.

Border and Legend: Black
 Background: Orange

Code Variable Legend
 A 500 FT
 B 1000 FT
 C 1 MILE
 D 1/2 MILE
 E 1500 FT
 F AHEAD
 Example: CW20-3F refers to "ROAD CLOSED AHEAD"

Road Class	Dimensions (inches)						
	A	B	C	D	E	F	G
Minimum	36	0.63	0.88	5D	3.75	2.5	2.25
Conventional	48	0.75	1.25	7D	5.25	3.5	3.0
Expwy/Fwy	60	0.75	1.25	9D	6.25	4.5	4.0

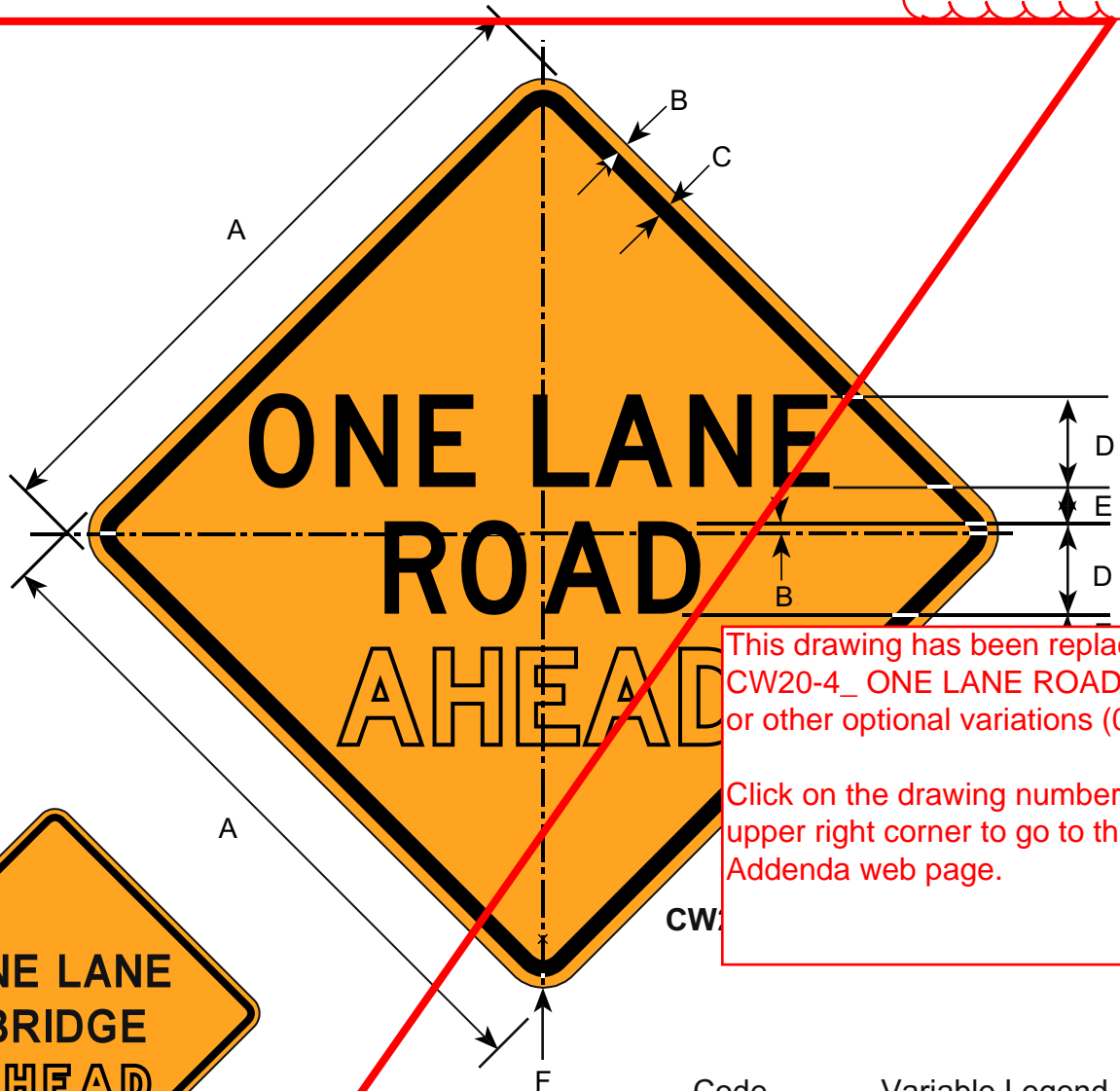

This drawing has been replaced with:
[CW20-4_ ONE LANE ROAD AHEAD](#)
 or other optional variations (02/10/12).
 Click on the drawing number in the
 upper right corner to go to the Interim
 Addenda web page.



CW20-4F (alt)

Alternate

- Code Variable Legend
- A 500 FT
 - B 1000 FT
 - C 1 MILE
 - D 1/2 MILE
 - E 1500 FT
 - F AHEAD
- Example: CW20-4F refers to "ONE LANE ROAD AHEAD"

Border and Legend: Black
 Background: Orange

Road Class	Dimensions (inches)					
	A	B	C	D	E	F
Minimum	36	0.63	0.88	5C	2.25	2.25
Conventional	48	0.75	1.25	7C	3.13	3.0
Expwy/Fwy	60	1.0	1.5	9C	4.5	3.75

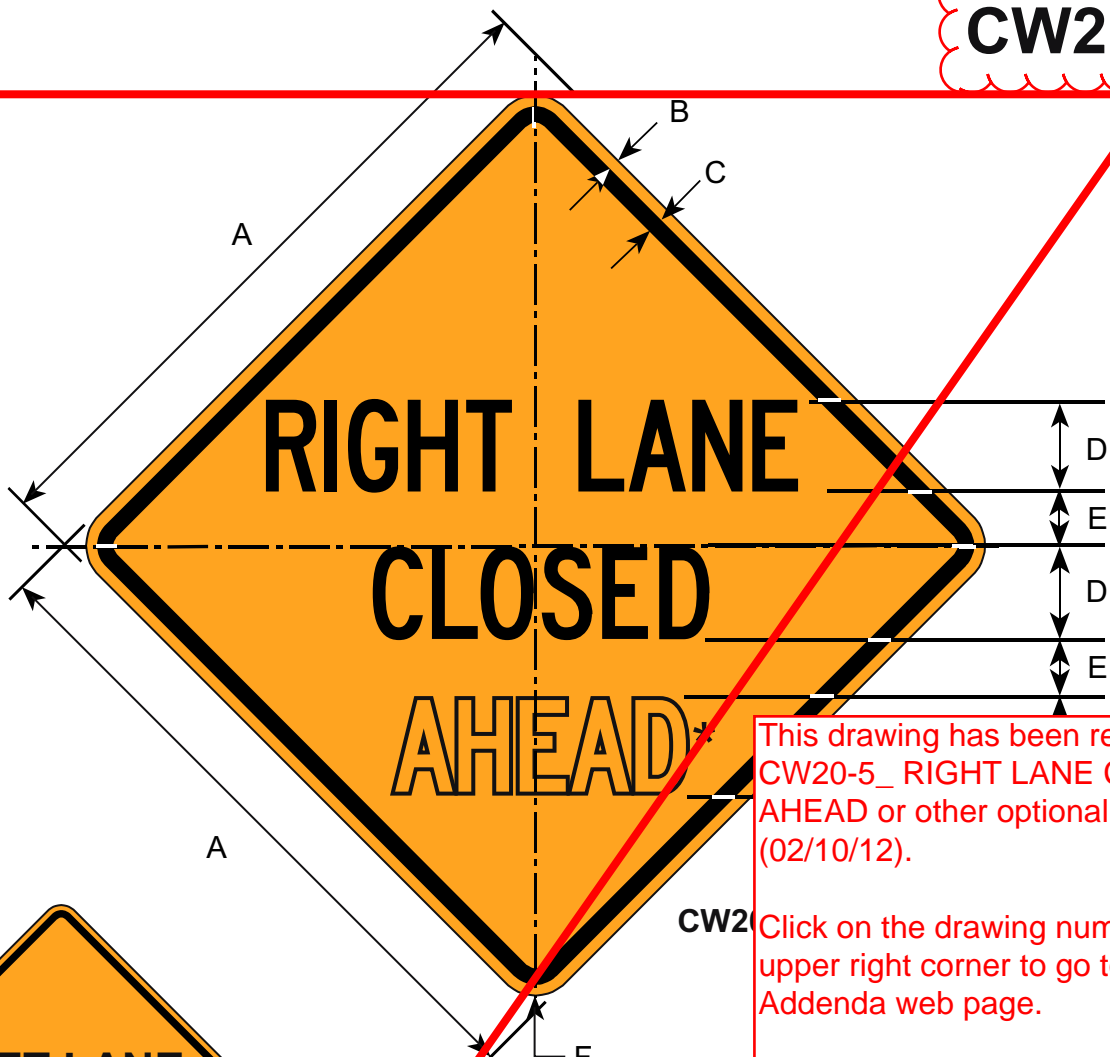

CW20-5F (alt)

Alternate

This drawing has been replaced with: CW20-5_ RIGHT LANE CLOSED AHEAD or other optional variations (02/10/12).
 Click on the drawing number in the upper right corner to go to the Interim Addenda web page.

Code	Variable Legend
A	500 FT
B	1000 FT
C	1 MILE
D	1/2 MILE
E	1500 FT
F	AHEAD

Example: CW20-5F refers to "RIGHT LANE ROAD AHEAD"

Border and Legend: Black
 Background: Orange

Road Class	Dimensions (inches)					
	A	B	C	D	E	F
Minimum	36	0.63	0.88	5C	2.75	2.25
Conventional	48	0.75	1.25	6C	3.38	3.0
Expwy/Fwy	60	1.0	1.5	8C	5.2	3.75

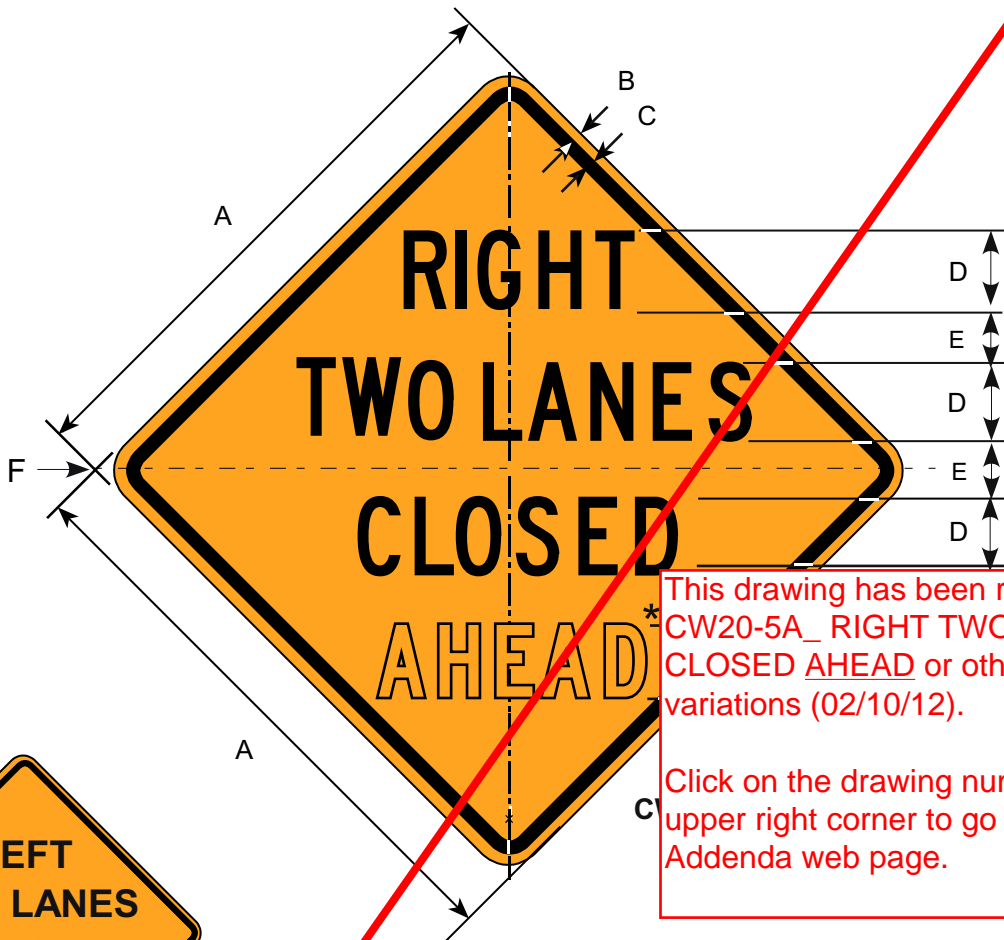

This drawing has been replaced with: CW20-5A_ RIGHT TWO LANES CLOSED AHEAD or other optional variations (02/10/12).
 Click on the drawing number in the upper right corner to go to the Interim Addenda web page.



Code	Variable Legend
A	500 FT
B	1000 FT
C	1 MILE
D	1/2 MILE
E	1500 FT
F	AHEAD

Example: CW20-5AF refers to "RIGHT TWO LANES CLOSED AHEAD".

Border and Legend: Black
 Background: Orange

Road Class	Dimensions (inches)					
	A	B	C	D	E	F
Minimum	36	0.63	0.88	5C	2.8	2.25
Conventional	48	0.75	1.25	6C	3.0	3.0
Expwy/Fwy	60	1.0	1.5	7C	4.0	3.75

CW20-5B_

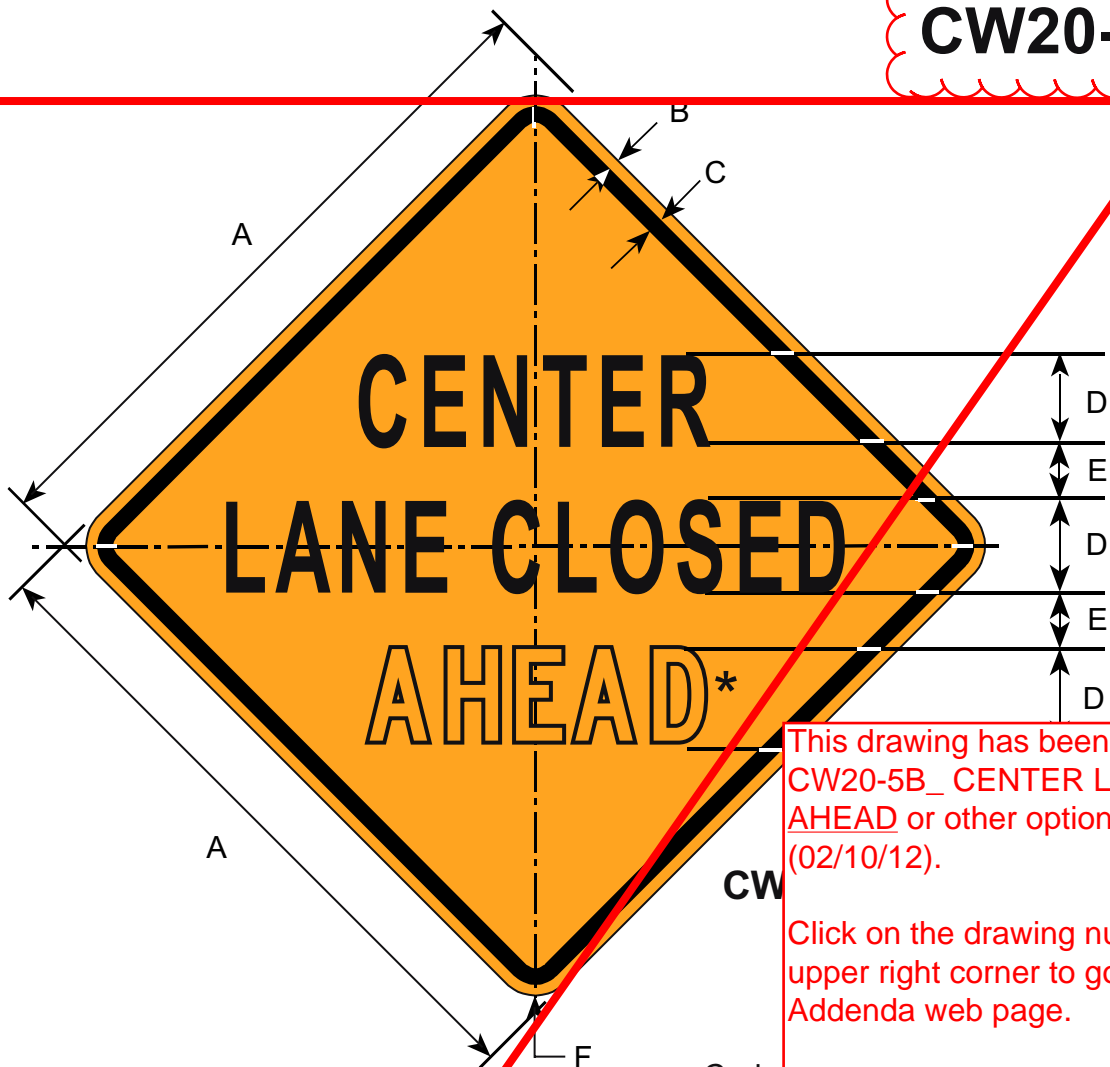

This drawing has been replaced with: CW20-5B_ CENTER LANE CLOSED AHEAD or other optional variations (02/10/12).

Click on the drawing number in the upper right corner to go to the Interim Addenda web page.

CW

Code variable Legend
 A 500 FT
 B 1000 FT
 C 1 MILE
 D 1/2 MILE
 E 1500 FT
 F AHEAD
 Example: CW20-5AF refers to "RIGHT TWO LANES CLOSED AHEAD".

Border and Legend: Black
 Background: Orange

Road Class	Dimensions (inches)					
	A	B	C	D	E	F
Minimum	36	0.63	0.88	5C	2.75	2.25
Conventional	48	0.75	1.25	6C	3.38	3.0
Expwy/Fwy	60	1.0	1.5	8C	5.2	3.75

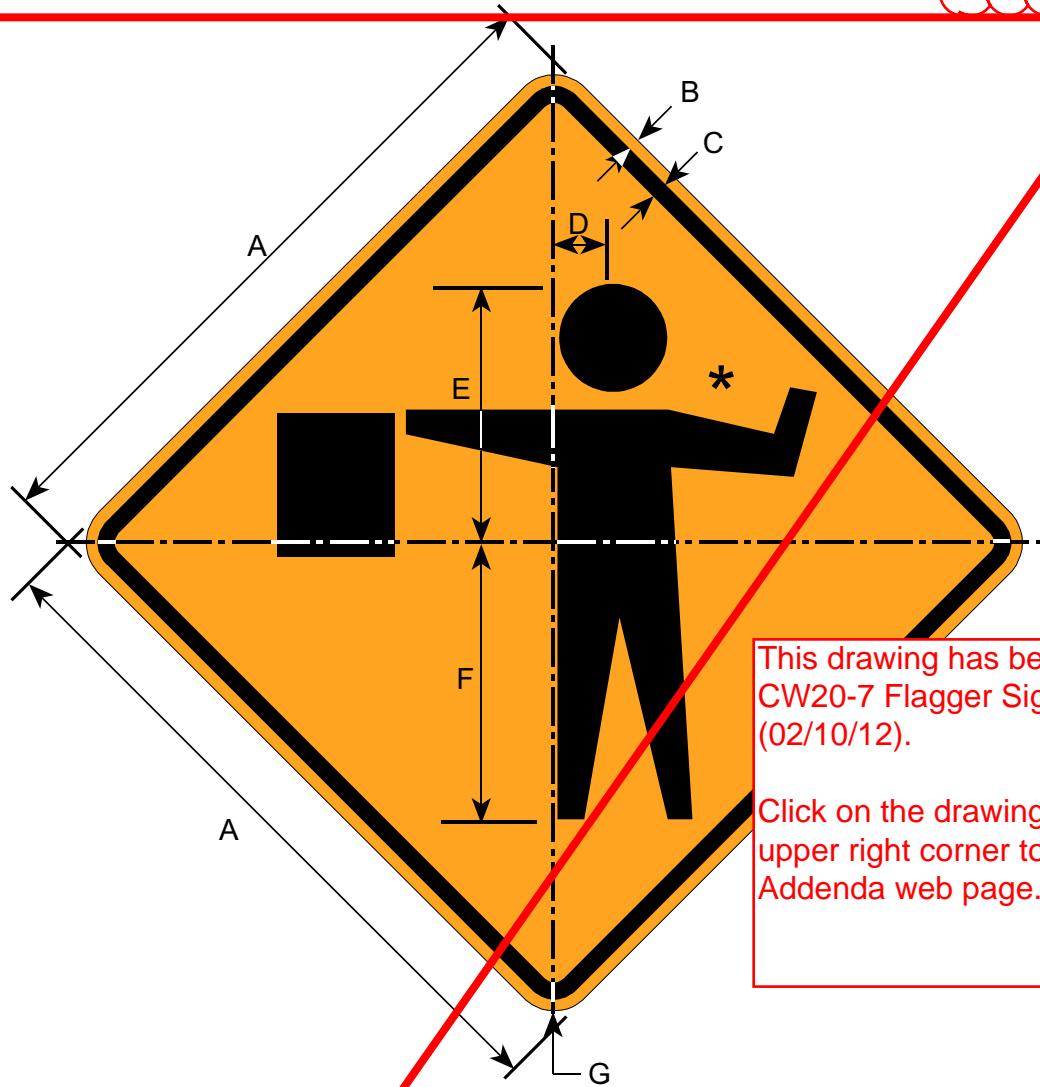

This drawing has been replaced with:
 CW20-7 Flagger Sign (Symbol)
 (02/10/12).
 Click on the drawing number in the
 upper right corner to go to the Interim
 Addenda web page.

*Make symbol proportional
 to the graphic shown.

Border and Legend: Black
 Background: Orange

Class	A	B	C	D	E	F	G
Minimum	36	0.63	0.88	2.75	13.5	14.63	2.25
Conventional	48	0.75	1.25	3.75	18.0	19.50	3.00
Expwy/Fwy	60	1.00	1.50	4.75	22.0	24.50	3.75

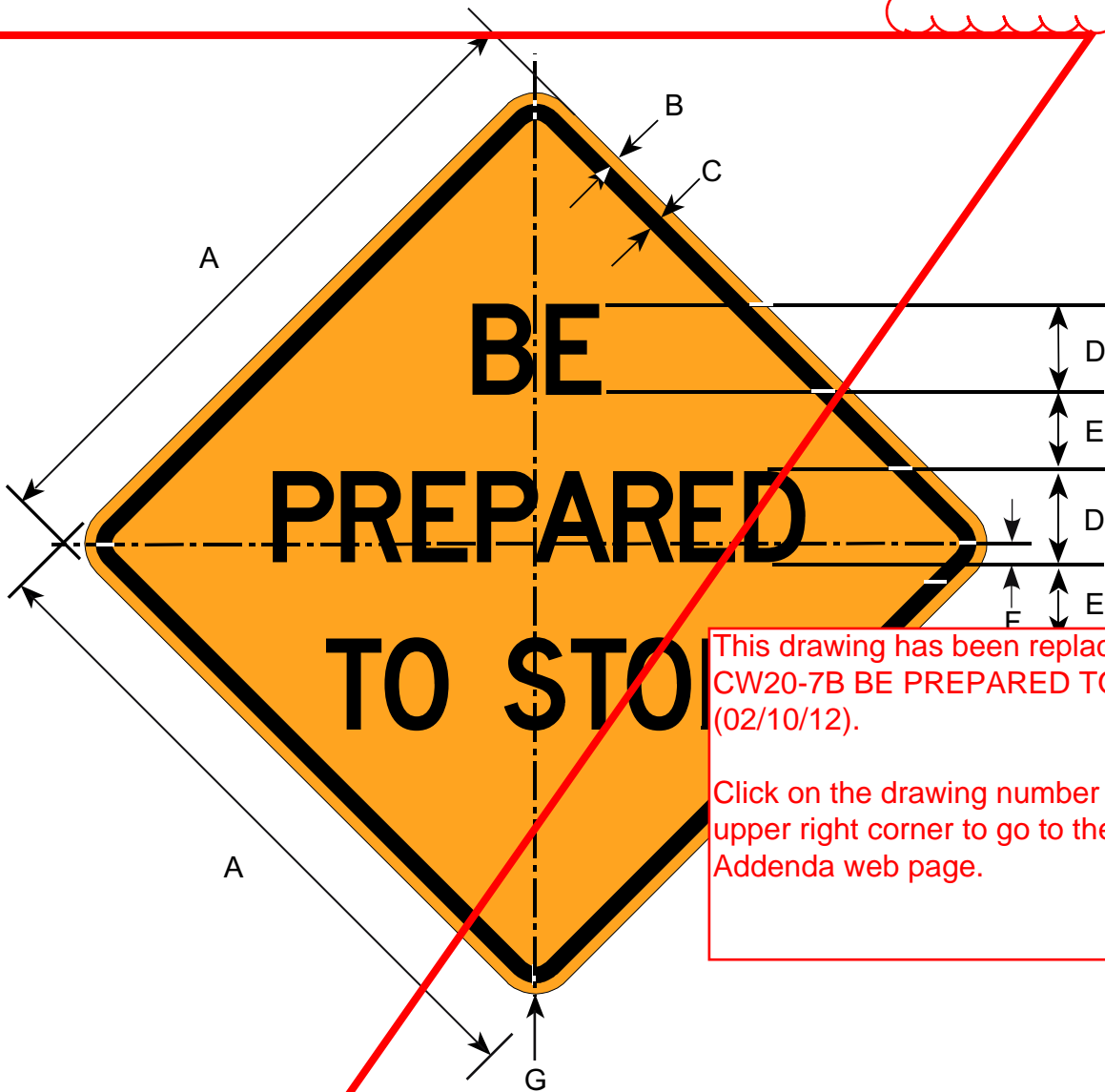

This drawing has been replaced with:
CW20-7B BE PREPARED TO STOP
 (02/10/12).

Click on the drawing number in the
 upper right corner to go to the Interim
 Addenda web page.

Border and Legend: Black
 Background: Orange

Prior to the 2003 revision of this manual this sign was
 numbered CW20-8.

Road Class	Dimensions (inches)						
	A	B	C	D	E	F	G
Minimum	36	0.63	0.88	6C	3.6	0.92	2.25
Conventional	48	0.75	1.25	8C	4.8	1.20	3.00
Expwy/Fwy	60	0.75	1.25	9C	5.4	1.40	3.00

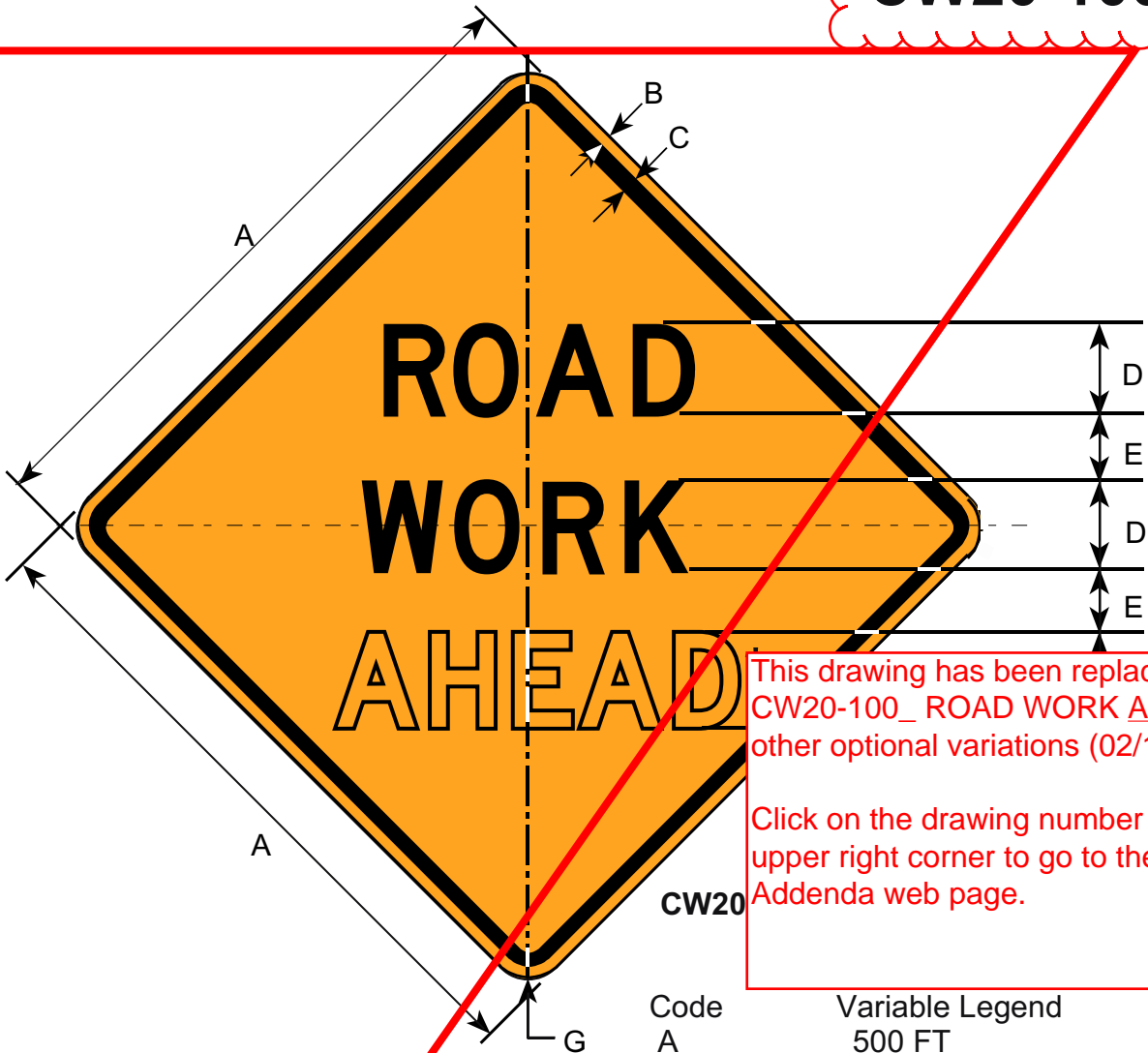

This drawing has been replaced with: CW20-100_ ROAD WORK AHEAD or other optional variations (02/10/12).
 Click on the drawing number in the upper right corner to go to the Interim Addenda web page.

Border and Legend: Black
 Background: Orange

- Code Variable Legend
- A 500 FT
 - B 1000 FT
 - C 1 MILE
 - D 1/2 MILE
 - E 1500 FT
 - F AHEAD
- Example: CW20-100F refers to "ROAD WORK AHEAD"

Prior to the 2002 publication of this manual, this sign was numbered CW21-4_.

Road Class	Dimensions (inches)						
	A	B	C	D	E	F	G
Minimum	36	0.63	0.88	5D	3.63	2.5	2.25
Conventional	48	0.75	1.25	7D	4.75	3.5	3.0
Expwy/Fwy	60	1.0	1.5	8D	5.5	4.0	3.75

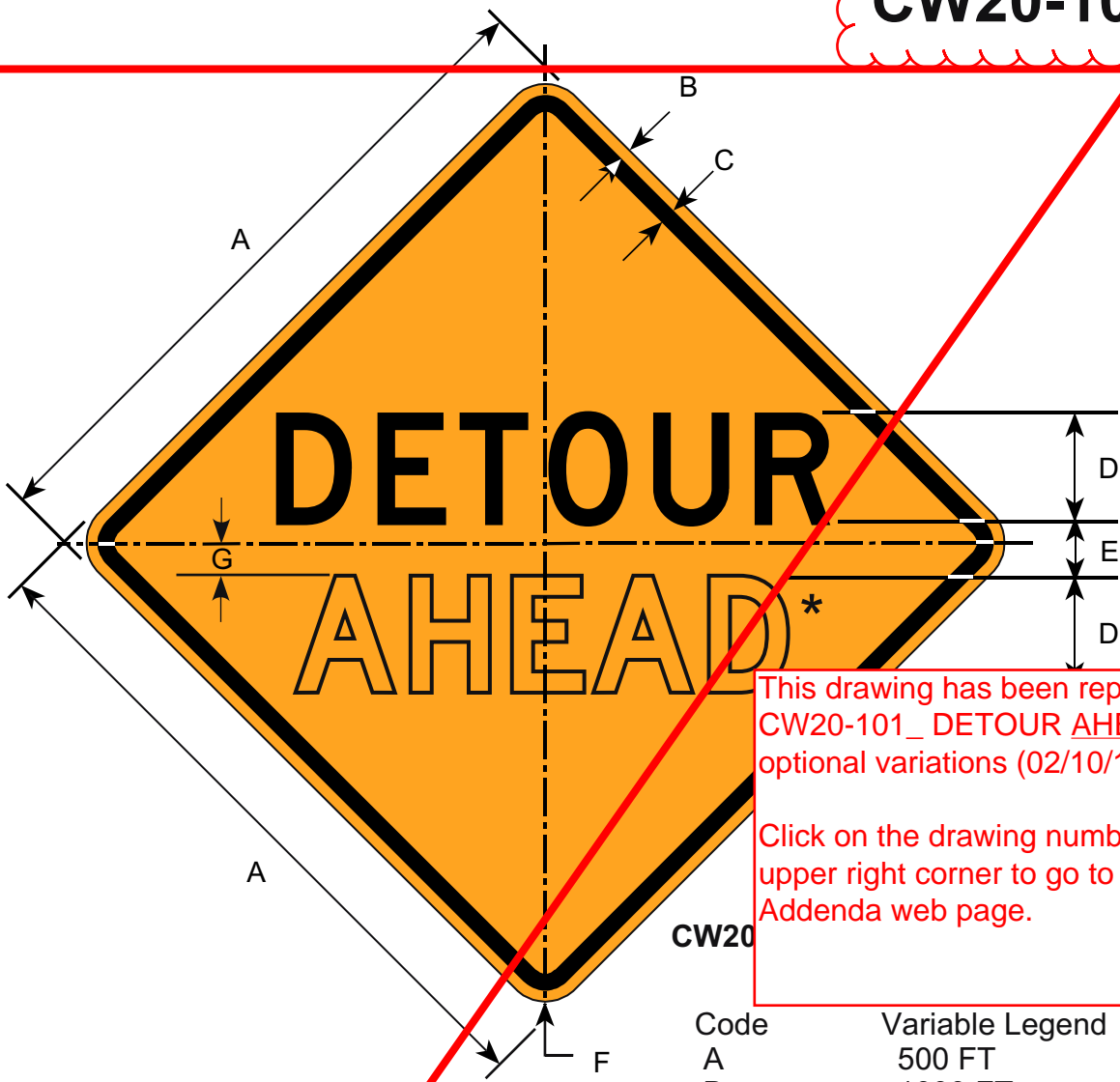

This drawing has been replaced with: CW20-101_ DETOUR AHEAD or other optional variations (02/10/12).

Click on the drawing number in the upper right corner to go to the Interim Addenda web page.

Border and Legend: Black
Background: Orange

Code	Variable Legend
A	500 FT
B	1000 FT
C	1 MILE
D	1/2 MILE
E	1500 FT
F	AHEAD
Example: CW20-101F refers to "DETOUR AHEAD"	

Prior to the 2002 publication of this manual, this sign was numbered CW21-2_.

Road Class	Dimensions (inches)						
	A	B	C	D	E	F	G
Minimum	36	0.63	0.88	6D	3.5	2.25	2.63
Conventional	48	0.75	1.25	8D	4.75	3.0	3.5
Expwy/Fwy	60	1.0	1.5	10D	6.0	4.0	4.42

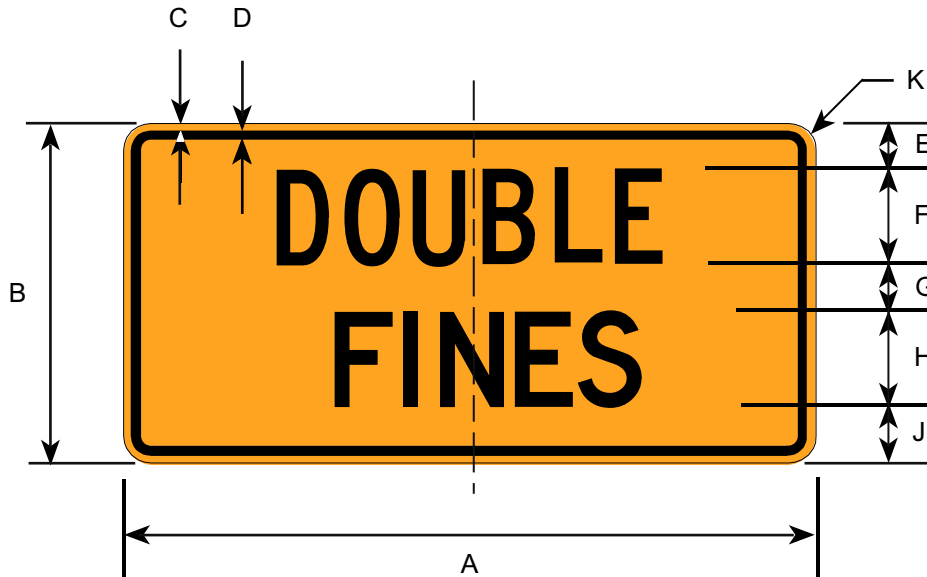

Border and Legend: Black
Background: Orange

Prior to the 2003 revision of this manual this sign was numbered AK-CW20-100.

Road Class	Dimensions (inches)									
	A	B	C	D	E	F	G	H	J	K
Conventional	30	18	0.50	0.75	2.5	5C	2.5	5D	3	1.88
Expressway	36	24	0.63	0.88	4.0	6C	4.0	6D	4	2.25
Freeway	48	30	0.75	1.25	6.0	6D	6.0	6D	6	3.00

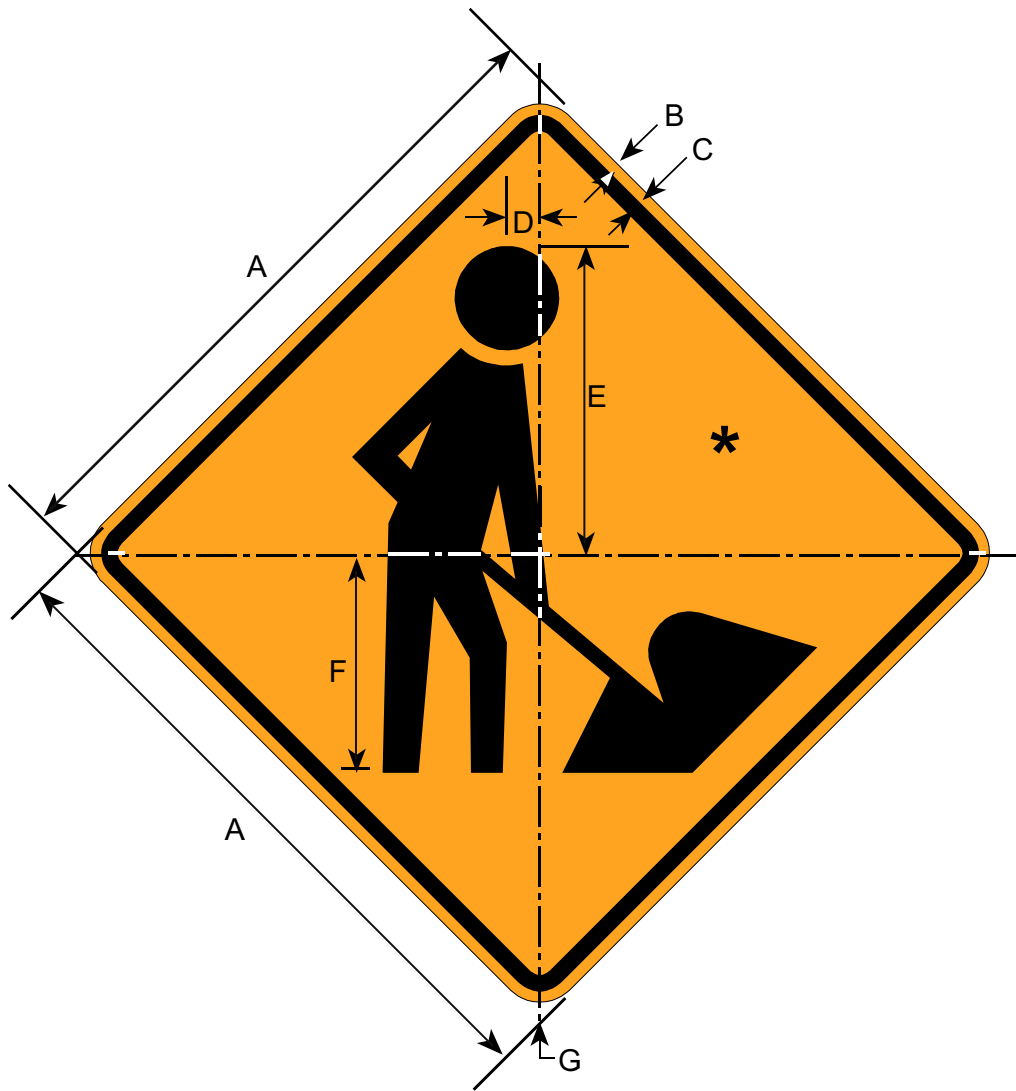

*Make symbol proportional to the graphic shown.

Border and Legend: Black
Background: Orange

Road Class	Dimensions (inches)						
	A	B	C	D	E	F	G
Minimum	30	0.50	0.75	1.88	14.00	10	1.88
Conventional	36	0.63	0.88	2.25	16.88	12	2.25
Expwy/Fwy	48	0.75	1.25	3.00	22.38	16	3.00

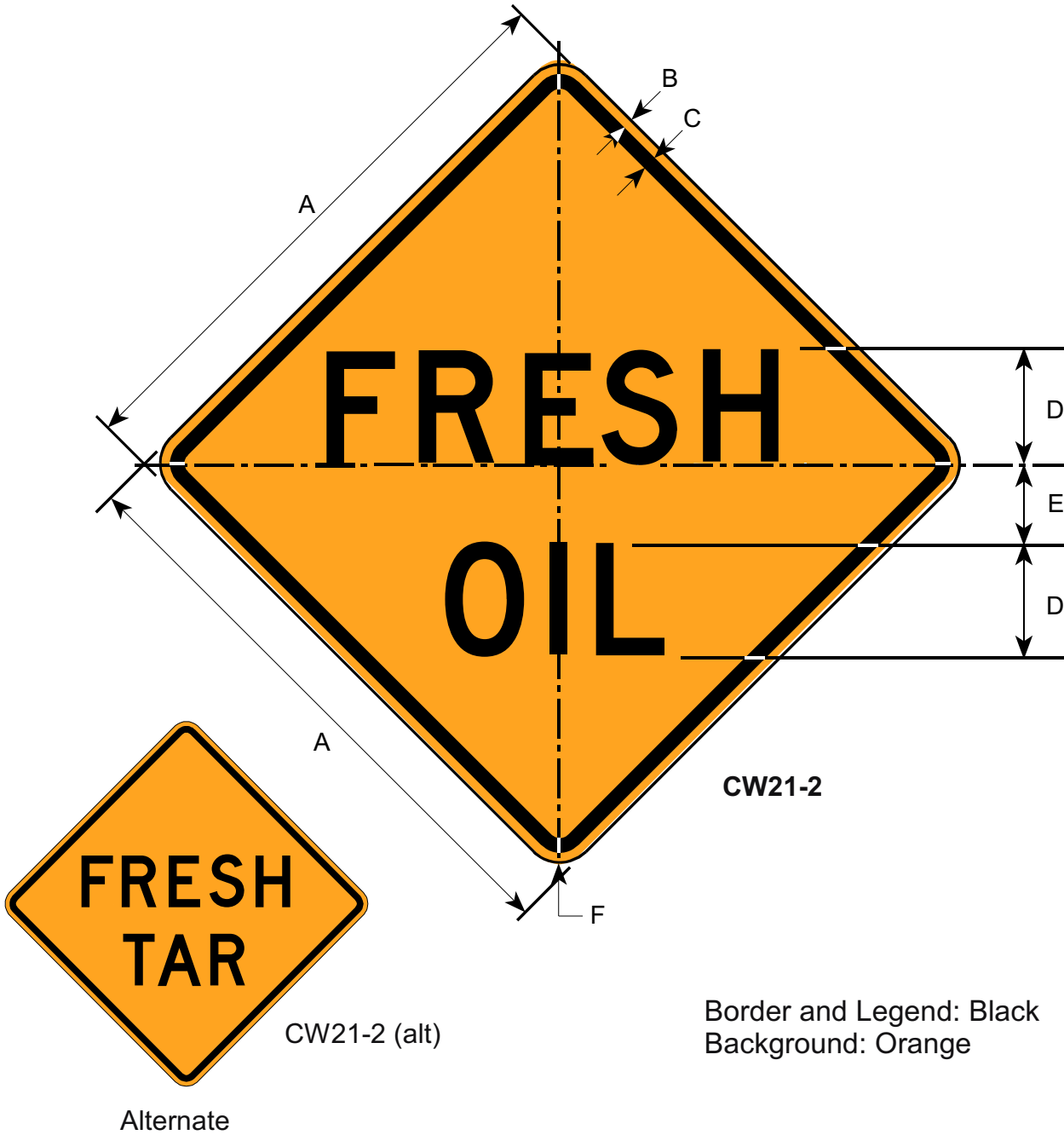

Class	A	B	C	D	E	F
Minimum	30	0.50	0.75	6D	4.0	1.88
Conventional	36	0.63	0.88	7D	5.0	2.25
Expwy/Fwy	48	0.88	1.13	9D	7.0	3.0

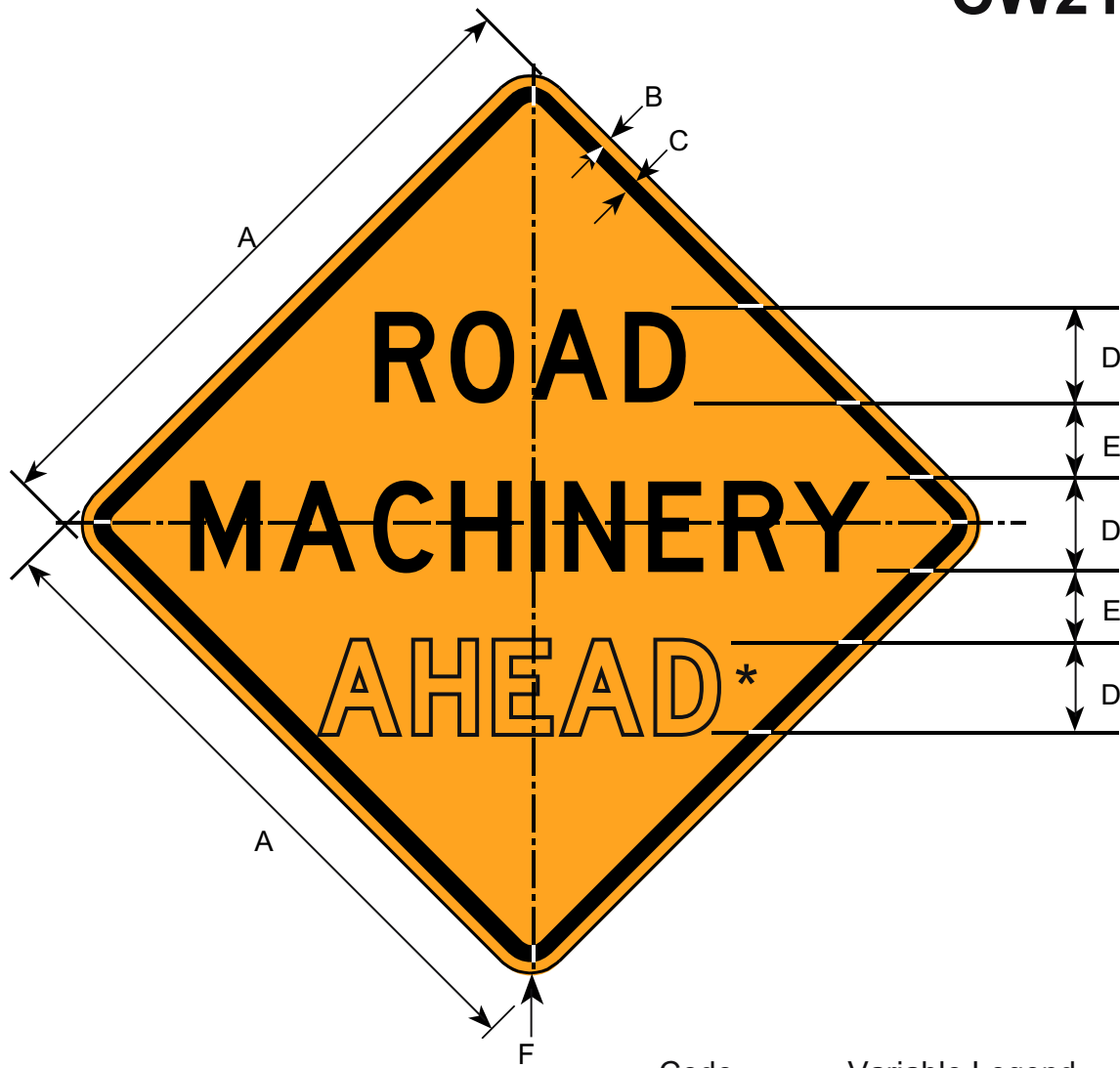

Border and Legend: Black
Background: Orange

Code	Variable Legend
A	500 FT
B	1000 FT
C	1 MILE
D	1/2 MILE
E	1500 FT
F	AHEAD

Example: CW21-3F refers to "ROAD MACHINERY AHEAD"

Road Class	Dimensions (inches)					
	A	B	C	D	E	F
Minimum	30	0.50	0.75	4D	3.5	1.88
Conventional	36	0.63	0.88	5D	4.0	2.25
Expwy/Fwy	48	0.75	1.25	7D	5.0	3.0

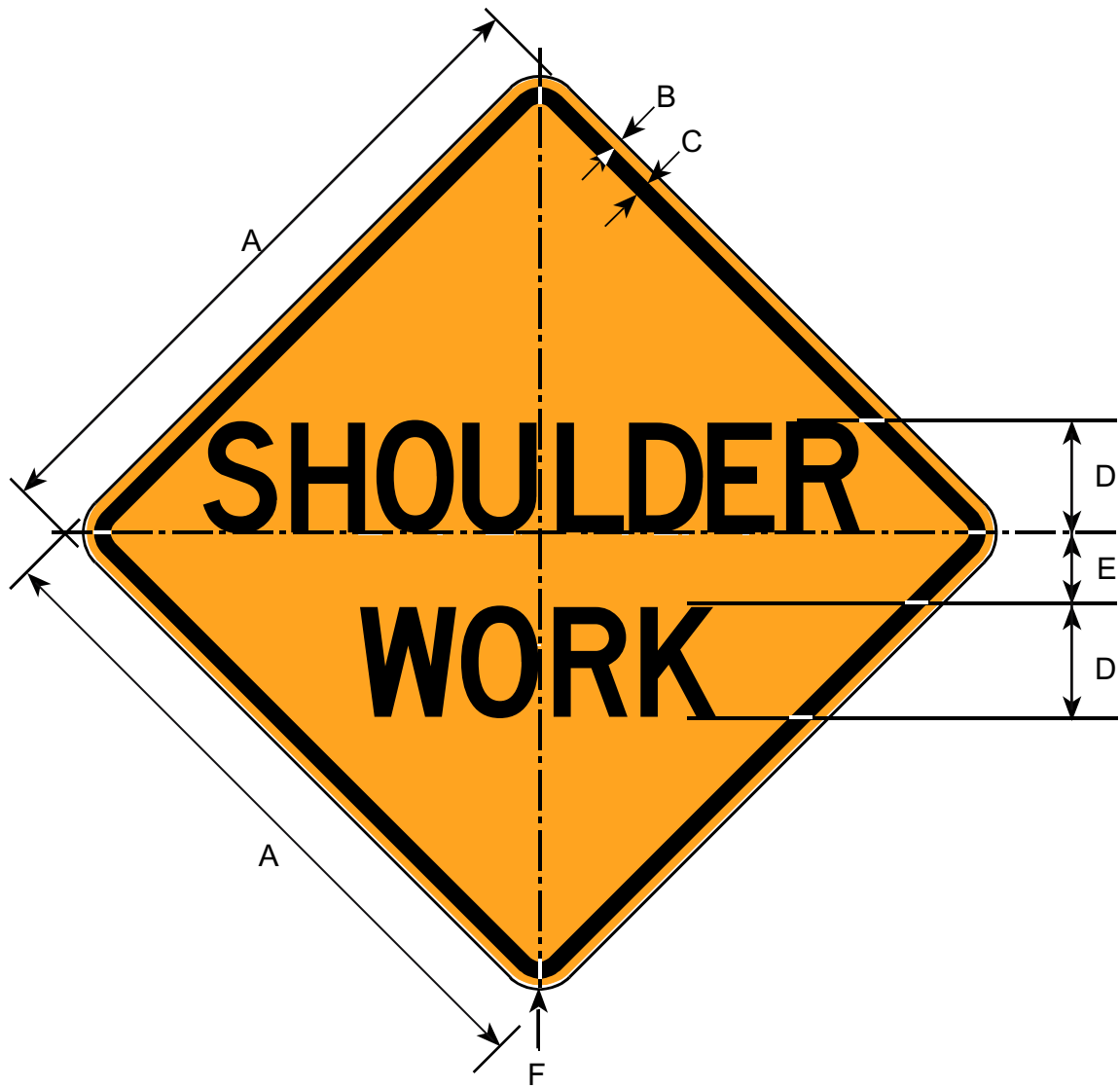

Border and Legend: Black
 Background: Orange

Road Class	Dimensions (inches)					
	A	B	C	D	E	F
Minimum	30	0.50	0.75	5C	3.0	1.88
Conventional	36	0.63	0.88	6C	3.5	2.25
Expwy/Fwy	48	0.75	1.25	8C	4.5	3.00

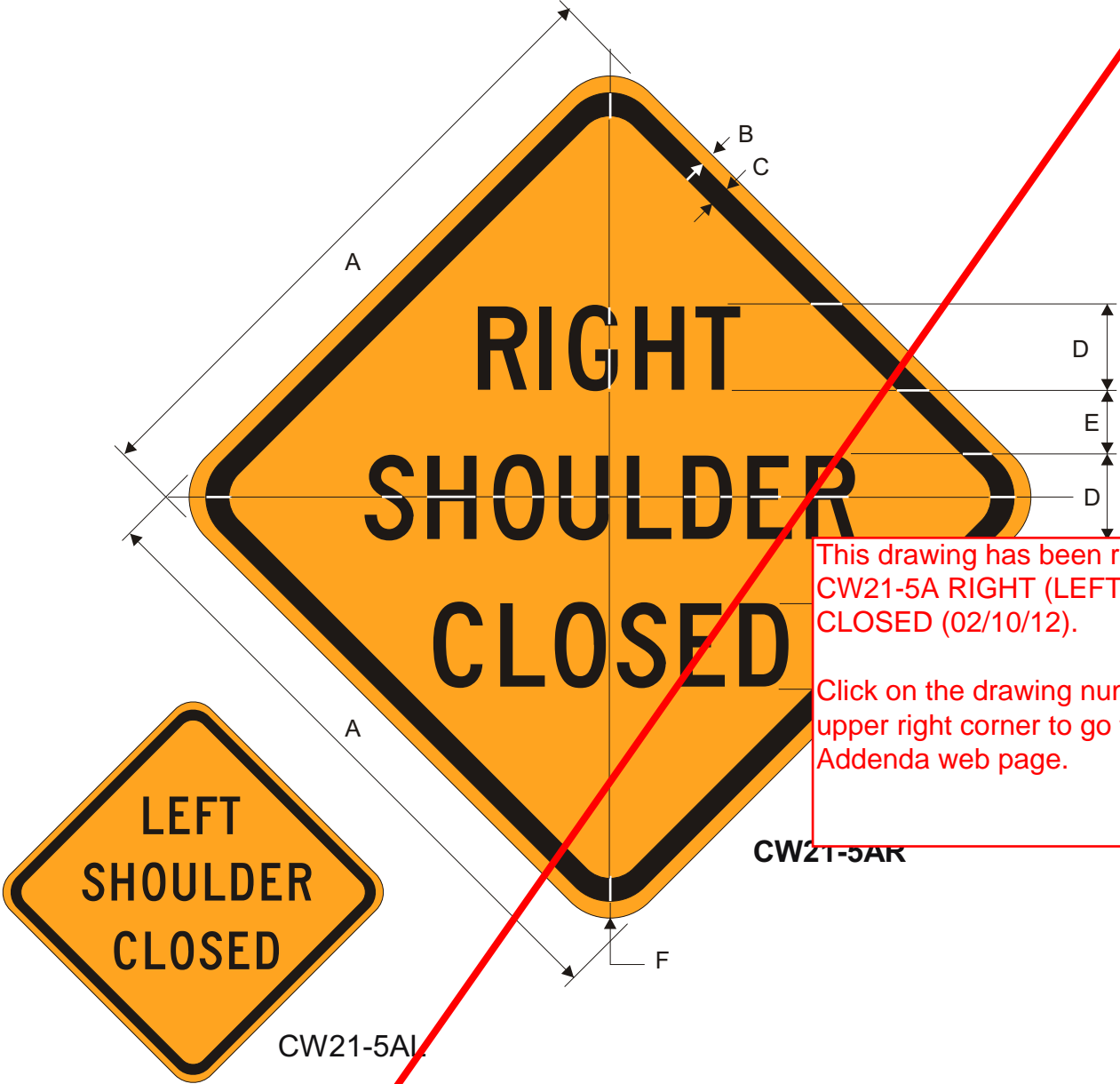

This drawing has been replaced with:
 CW21-5A RIGHT (LEFT) SHOULDER
 CLOSED (02/10/12).
 Click on the drawing number in the
 upper right corner to go to the Interim
 Addenda web page.

CW21-5AR

CW21-5AL

Border and Legend: Black
 Background: Orange

Road Class	Dimensions (inches)					
	A	B	C	D	E	F
Minimum	36	0.63	0.88	5C	3.68	2.25
Conventional	48	0.75	1.25	7C	4.8	3.0
Expwy/Fwy	60	0.75	1.25	8C	5.48	3.0

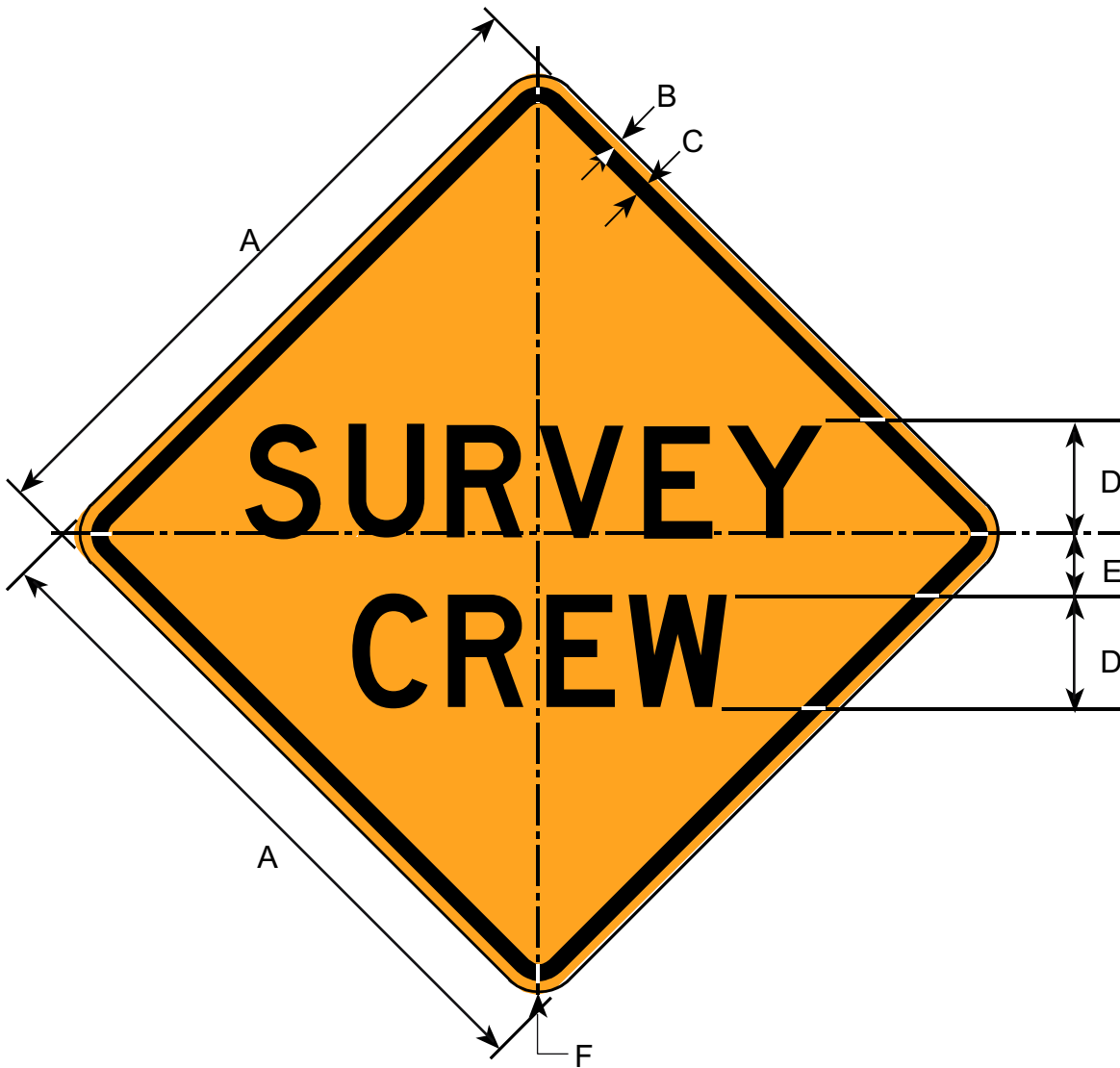

Border and Legend: Black
Background: Orange

Road Class	Dimensions (inches)					
	A	B	C	D	E	F
Minimum	30	0.50	0.75	5D	3.0	1.88
Conventional	36	0.63	0.88	6D	3.5	2.25
Expwy/Fwy	48	0.75	1.25	8D	4.5	3.00

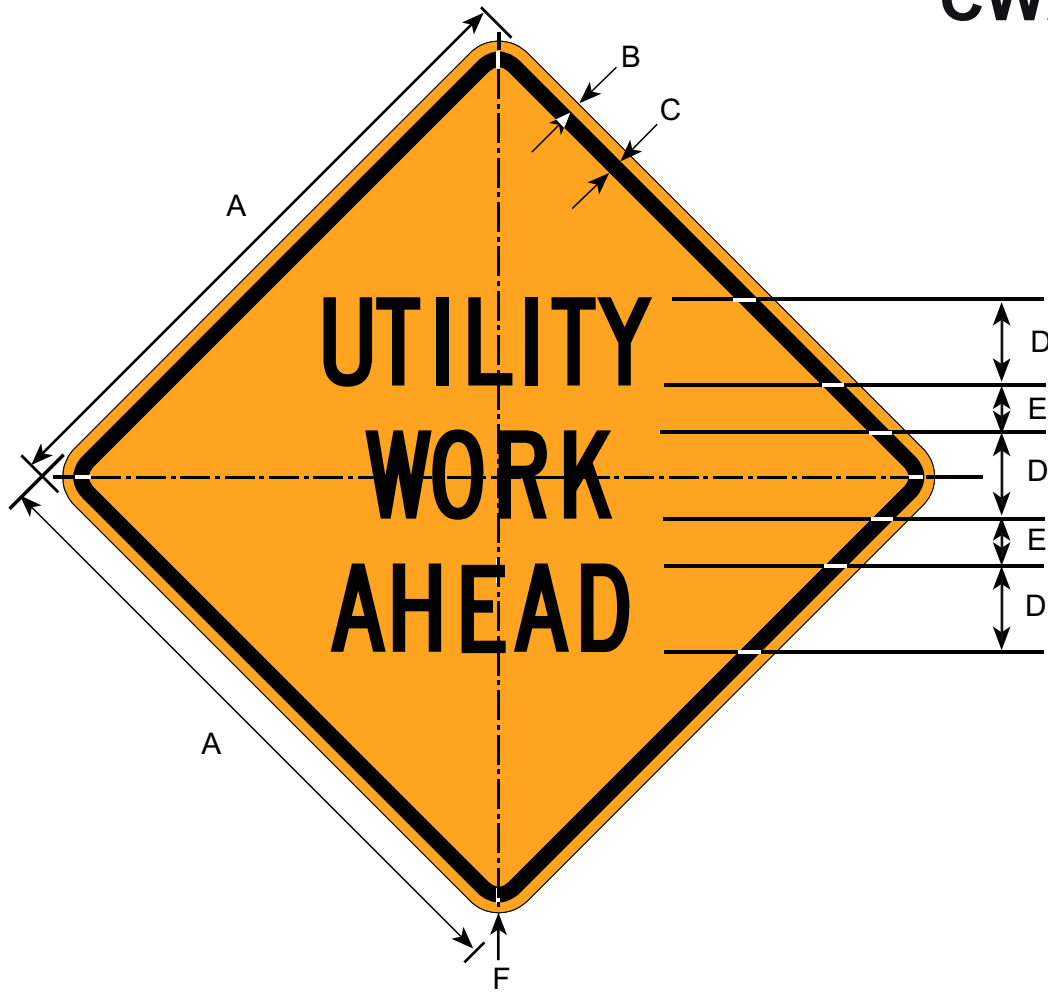

Border and Legend: Black
Background: Orange

Road Class	Dimensions (inches)					
	A	B	C	D	E	F
Minimum	30	0.50	0.75	5C	3.0	1.88
Conventional	36	0.63	0.88	5C	3.3	2.25
Expwy/Fwy	48	0.75	1.25	6C	4.0	3.00

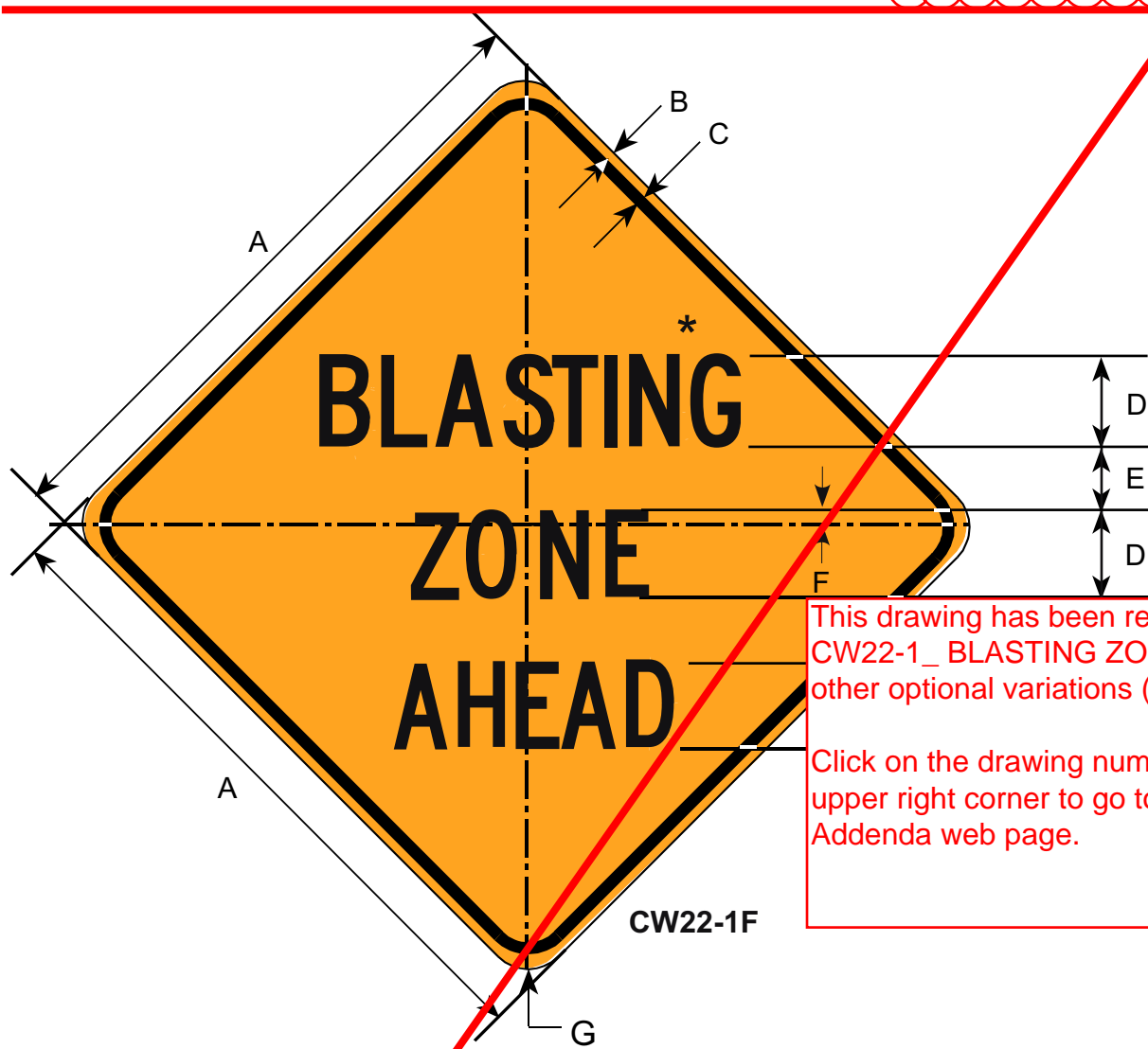

This drawing has been replaced with:
 CW22-1_ BLASTING ZONE AHEAD or
 other optional variations (02/10/12).
 Click on the drawing number in the
 upper right corner to go to the Interim
 Addenda web page.

CW22-1F

This sign replaces former BLASTING ZONE 1000 FT (CW22-100) sign.

Border and Legend: Black
 Background: Orange

* Reduce spacing 40%

Code	Variable Legend
A	500 FT
B	1000 FT
C	1 MILE
D	1/2 MILE
E	1500 FT
F	AHEAD
Example: CW22-1A refers to "BLASTING ZONE 500 FT"	

Road Class	Dimensions (inches)						
	A	B	C	D	E	F	G
Minimum	36	0.63	0.88	5C	3.0	1.0	2.25
Conventional	48	0.75	1.25	7C	4.0	1.5	3.0
Expwy/Ewy	60	1.0	1.5	8C	6.0	2.0	3.75

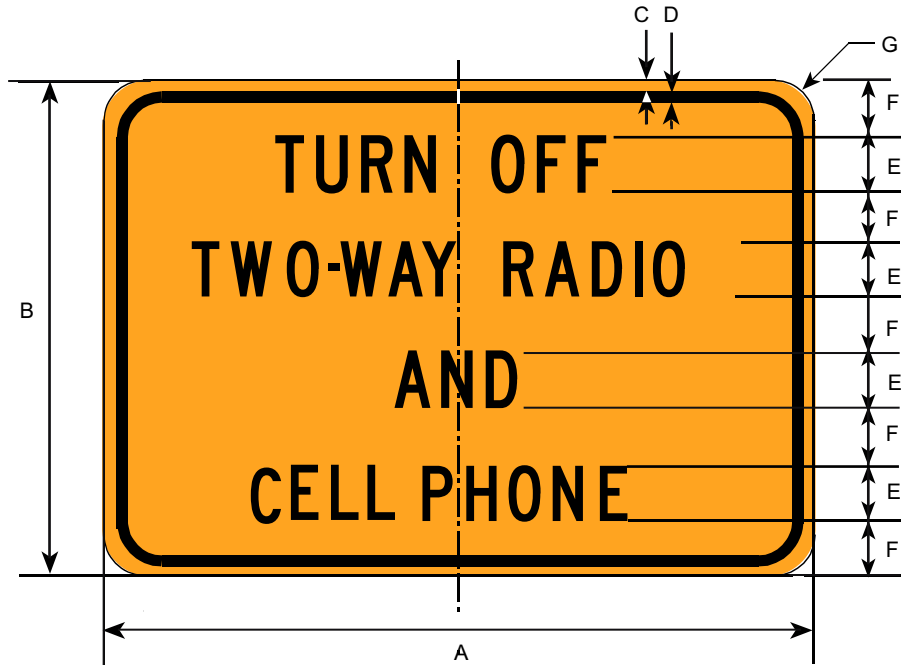

Border and Legend: Black
 Background: Orange

Road Class	Dimensions (inches)						
	A	B	C	D	E	F	G
Conv & Min	42	36	0.63	0.88	4C	4	2

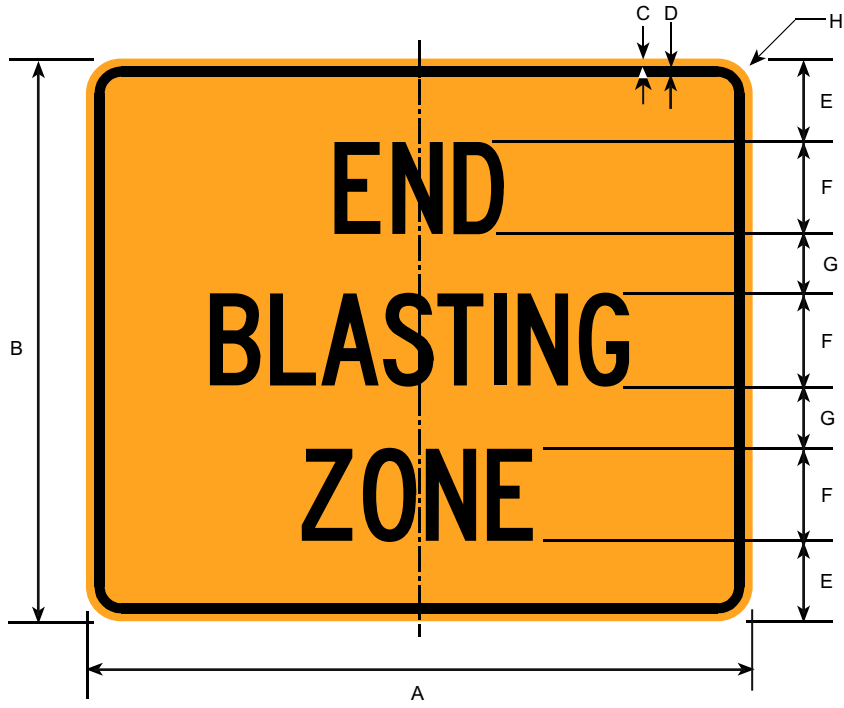

Border and Legend: Black
 Background: Orange

Road Class	Dimensions (inches)							
	A	B	C	D	E	F	G	H
Minimum	36	30	0.50	0.75	4.5	5C	3.0	1.88
Conventional	42	36	0.63	0.88	4.0	7C	3.5	2.25

CW23-100 (Front)

STOP-SLOW PADDLE *

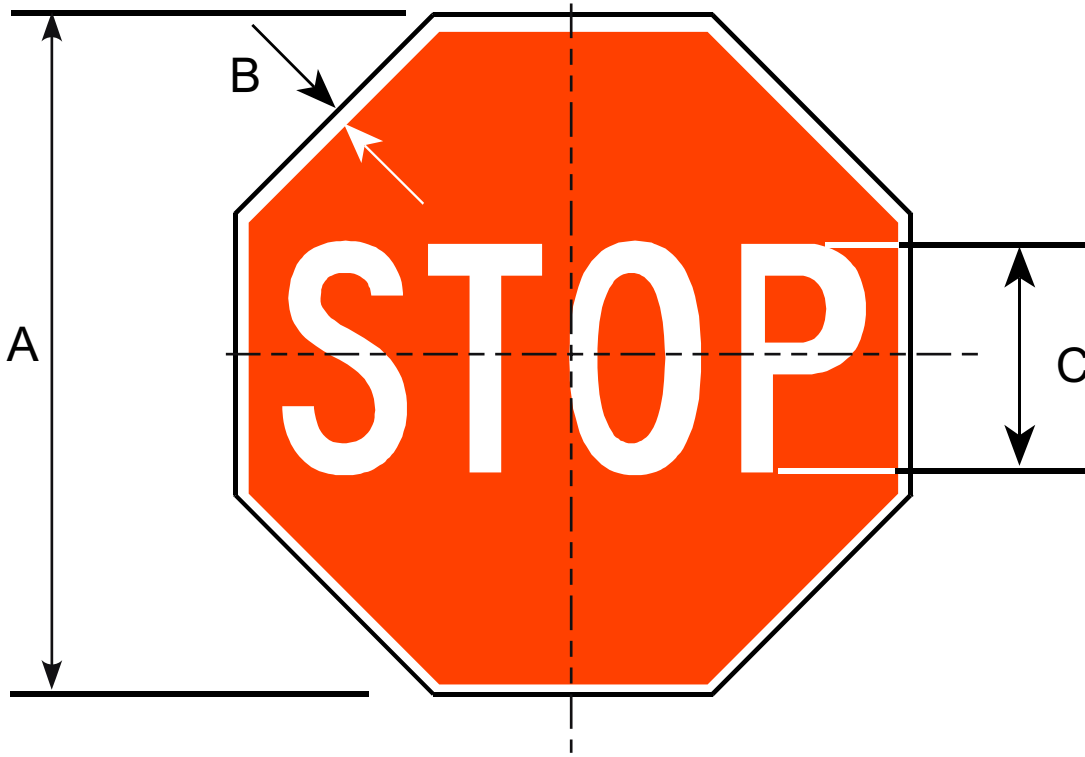

Border and Legend: White
Background: Red

Prior to the 2002 publication of this manual, this sign was numbered CW23-1A.

Road Class	Dimensions (inches)		
	A	B	C
Local Rds w Spd Limits <= 25MPH	18	0.38	6C
All Other Roads	24	0.63	8C

CW23-100 (Back)

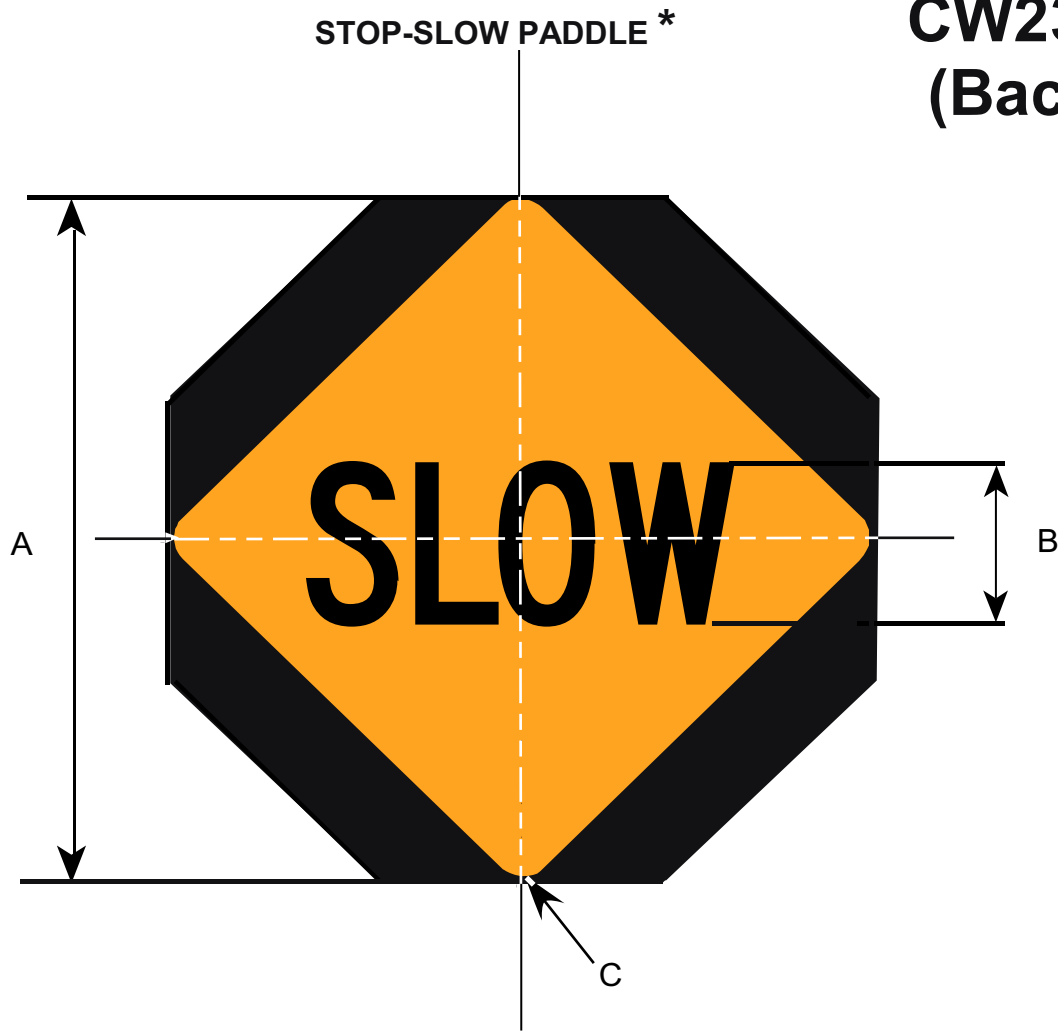

Legend: Black
 Background: Orange
 Area Outside Diamond: Black

Prior to the 2002 publication of this manual, this sign was numbered CW23-1B.

Road Class	Dimensions (inches)		
	A	B	C
Local Rds w Spd Limits <=25MPH	18	6B	1.0
All Other Roads	24	7B	1.25

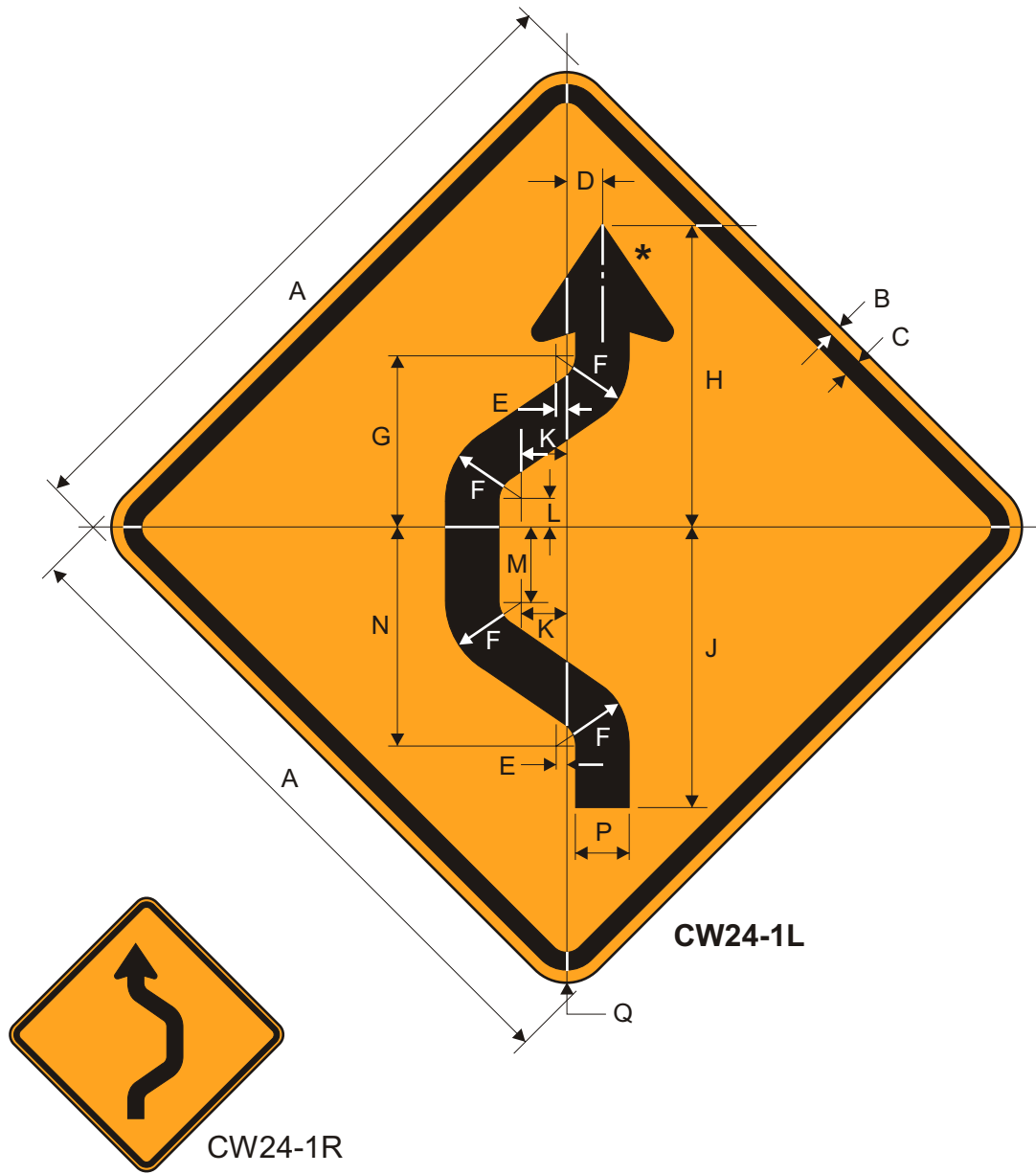

Legend: Black
 Background: Orange
 * See Appendix B-1 for
 Standard Arrow Details.

Road Class	Dimensions (inches)														
	A	B	C	D	E	F	G	H	J	K	L	M	N	P	Q
Minimum	30	0.50	0.75	1.60	0.28	3.08	7.41	13.57	12.57	2.36	1.48	3.52	9.49	2.4	1.88
Conventional	36	0.63	0.88	1.92	0.34	3.7	8.89	16.28	15.08	2.83	1.78	4.23	11.38	2.88	2.25
Expwy/Fwy	48	0.75	1.25	2.56	0.45	4.93	11.85	21.71	20.11	3.78	2.37	5.64	15.18	3.84	3.0

CW24-1A

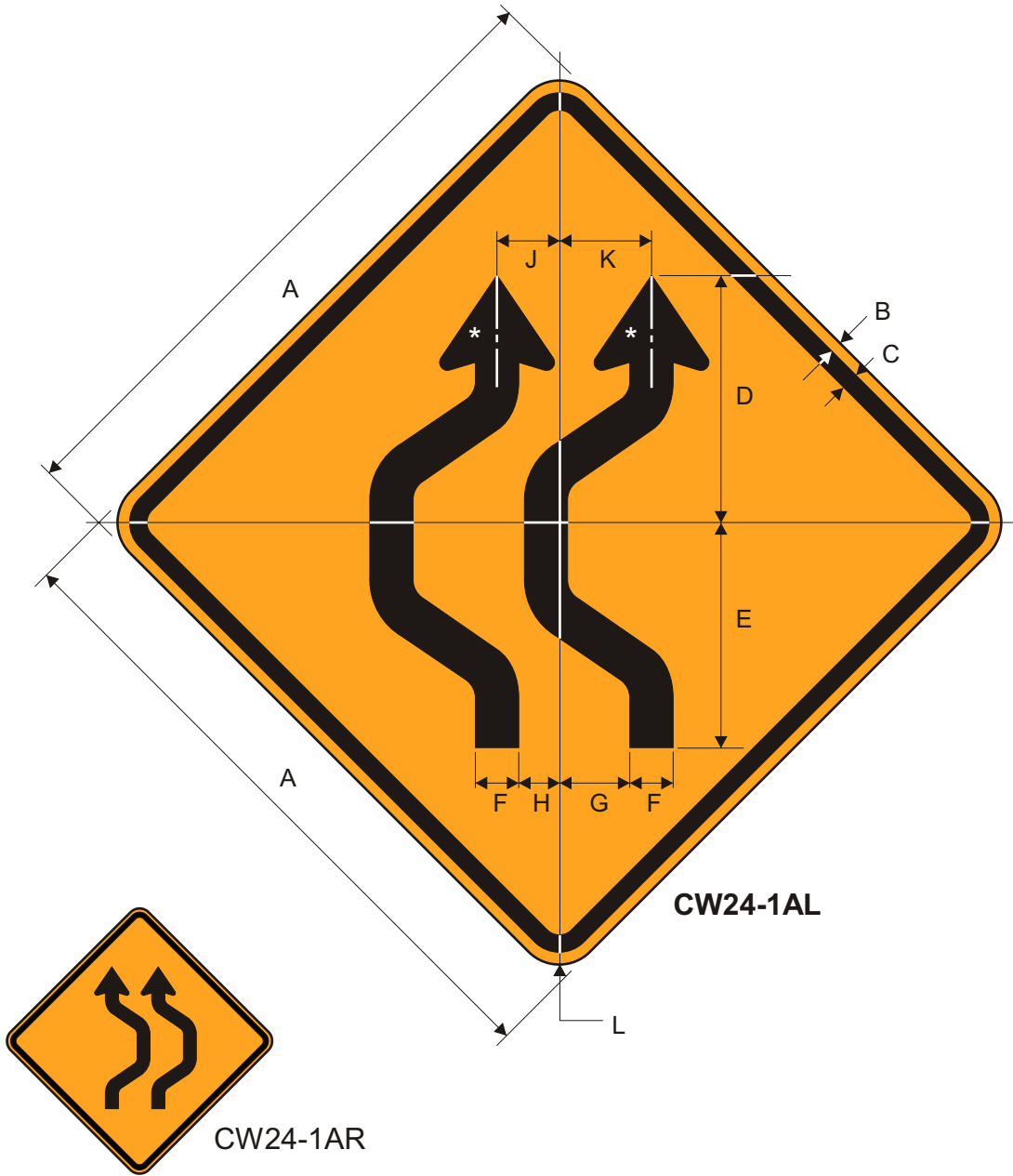

Legend: Black
Background: Orange

*Reduce arrow from CW24-1 15%.

Road Class	Dimensions (inches)										
	A	B	C	D	E	F	G	H	J	K	L
Minimum	30	0.50	0.75	11.53	10.68	2.0	3.24	1.88	2.9	4.26	1.88
Conventional	36	0.63	0.88	13.8	12.82	2.4	3.88	2.24	3.47	5.11	2.25
Expwy/Fwy	48	0.75	1.25	18.46	17.09	3.25	5.2	3.04	4.68	6.83	3.0

CW24-1B

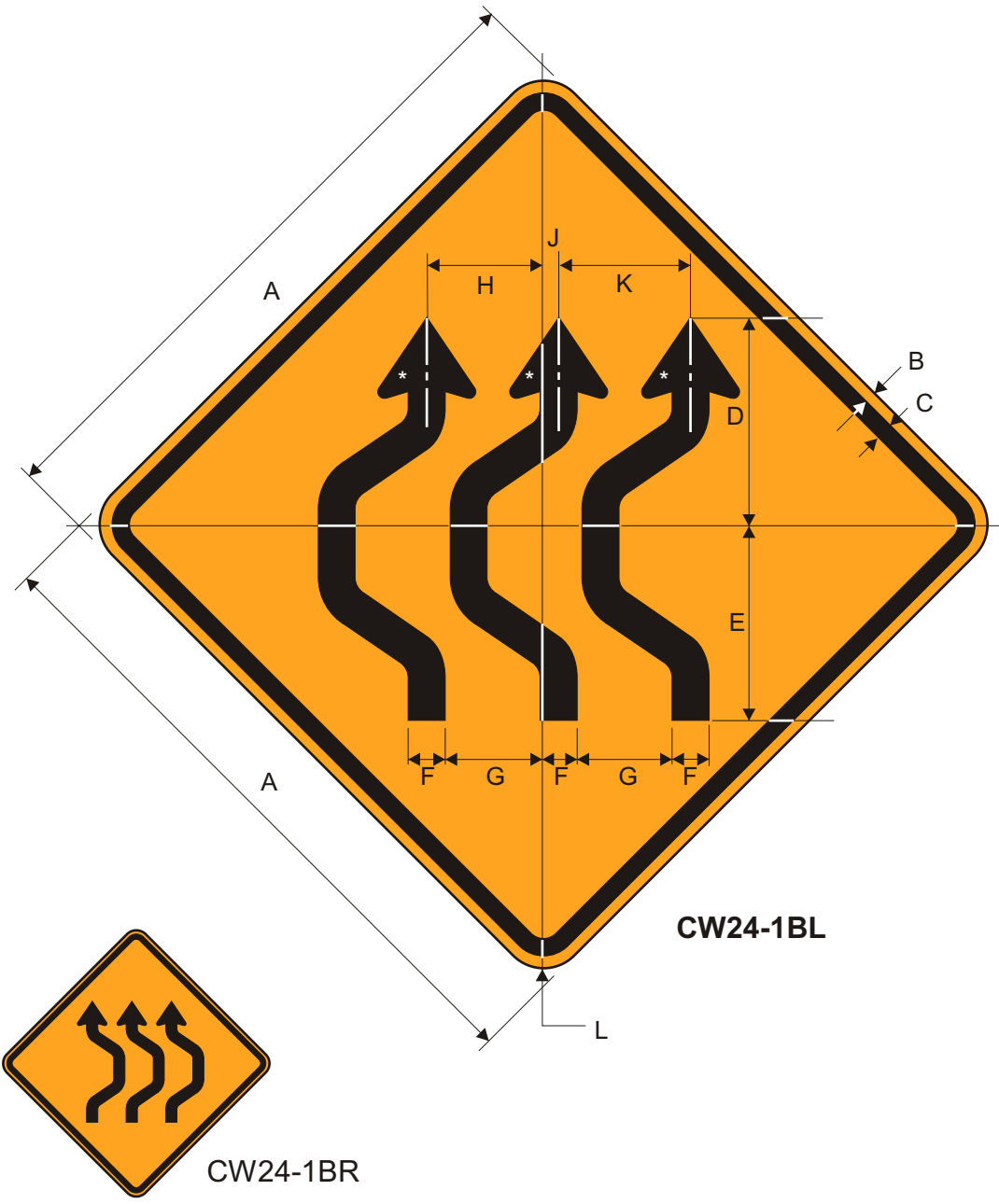

Legend: Black
Background: Orange

*Reduce arrow from CW24-1 30%.

Road Class	Dimensions (inches)										
	A	B	C	D	E	F	G	H	J	K	L
Minimum	30	0.50	0.75	9.49	8.81	1.68	4.72	5.56	0.84	6.4	1.88
Conventional	36	0.63	0.88	11.41	10.57	2.0	5.68	6.69	1.0	7.69	2.25
Expwy/Fwy	48	0.75	1.25	15.17	14.05	2.68	7.53	8.85	1.32	10.21	3.0

DESTINATION SIGNS - CONVENTIONAL RDS

D1-1 to D3-2D

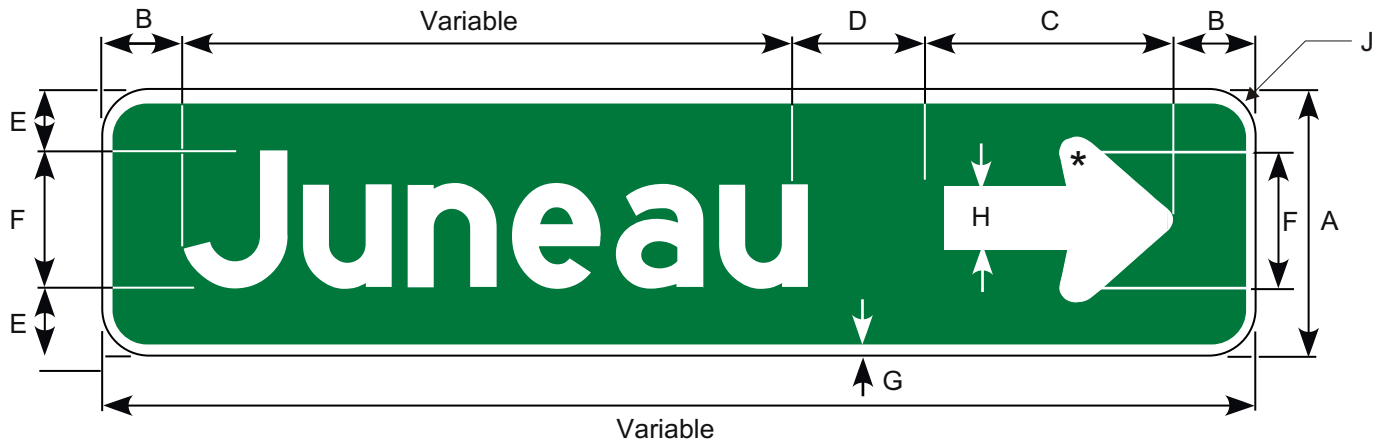

Border and Legend: White
Background: Green

*See Appendix B-1 for Standard Arrow Details.

Letter Size (inches)	Dimensions (inches)								
	A	B	C	D	E	F	G	H	J
6 / 4.5	12	6.0	9.56	6±	3.0	6.0	0.63	2.6	0.75
8 / 6	24	8.0	12.75	8±	8.0	8.0	0.75	3.48	1.5
10.7 / 8	24	11	17.25	11±	6.65	10.7	1.25	4.65	1.5
13.3 / 10	36	13	20.25	13±	11.35	13.3	2.0	5.78	2.25
16 / 12	36	16	25	16±	10	16	2.0	6.96	2.25

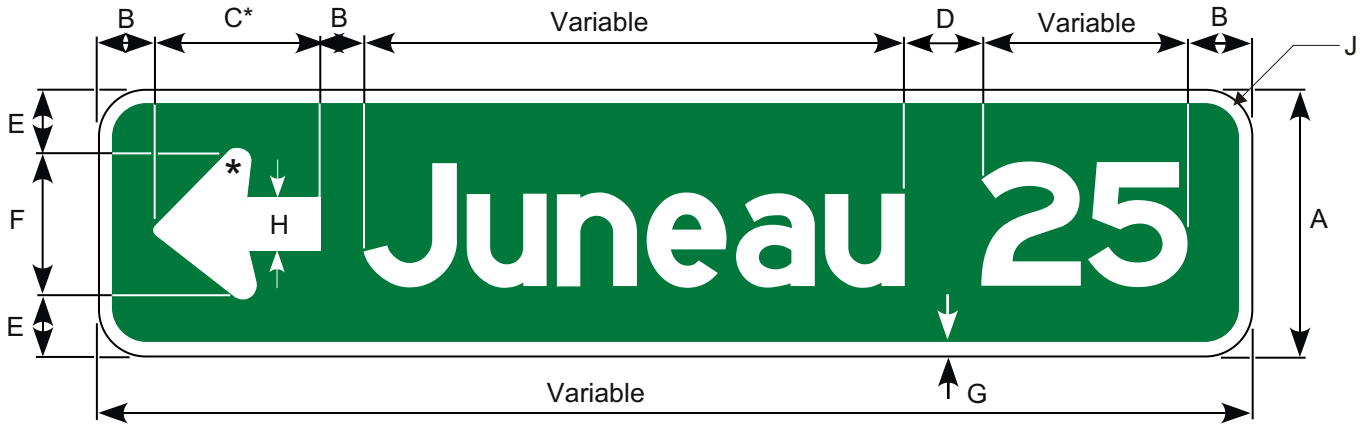

Border and Legend: White
Background: Green

*See Appendix B-1 for Arrow Details.

Letter Size (inches)	Dimensions (inches)								
	A	B	C	D	E	F	G	H	J
6 / 4.5	12	6.0	9.56	6±	3.0	6.0	0.63	2.6	0.75
8 / 6	24	8.0	12.75	8±	8.0	8.0	0.75	3.48	1.5
10.7 / 8	24	11	17.25	11±	6.65	10.7	1.25	4.65	1.5
13.3 / 10	36	13	20.25	13±	11.35	13.3	2.0	5.78	2.25
16 / 12	36	16	25	16±	10	16	2.0	6.96	2.25

D1-100

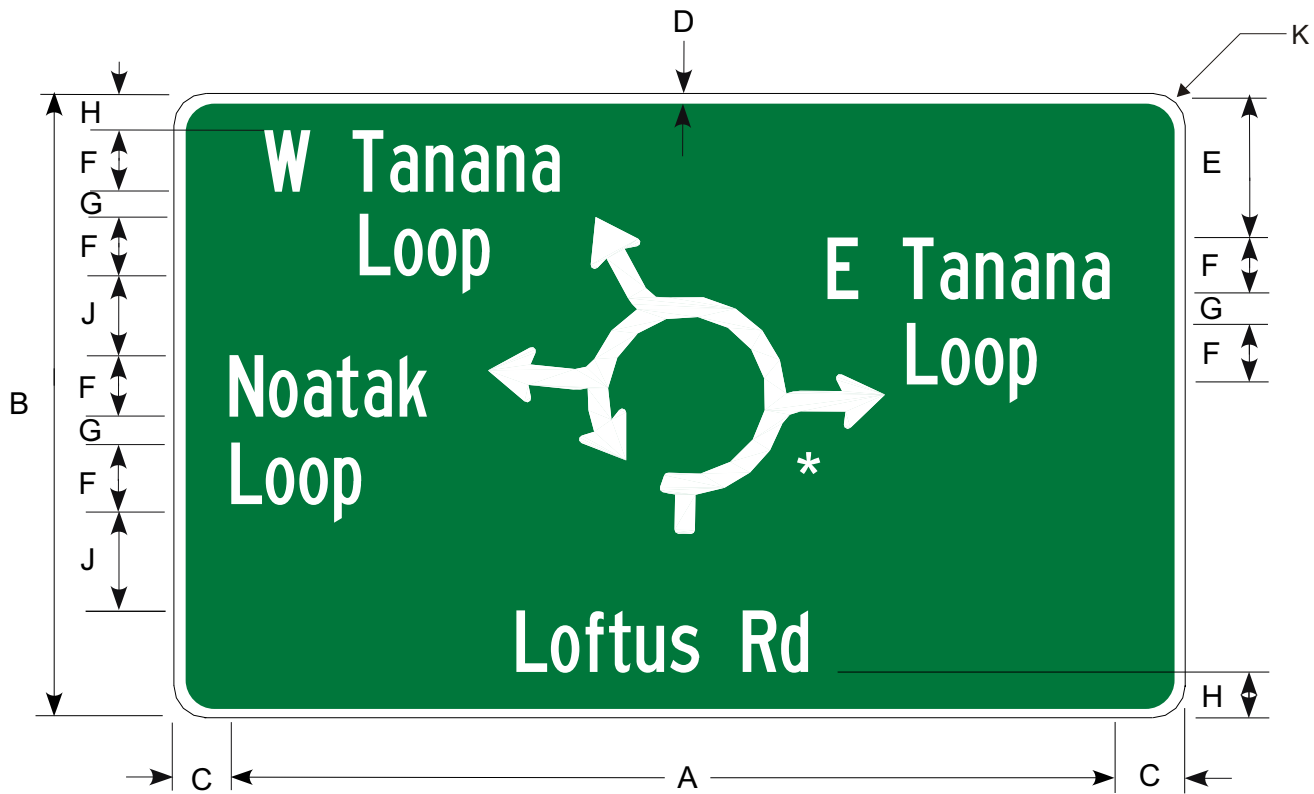

Legend: White
Background: Green

* See Appendix B-1 for Standard Arrow Details.

Letter Size (Inches)	Dimensions (inches)									
	A	B	C	D	E	F	G	H	J	K
6.0 / 4.5	VAR	VAR	6.0	1.5	VAR	6.0	4.0	6.0	Min. 9	VAR
8.0 / 6.0	VAR	VAR	8.0	1.75	VAR	8.0	6.0	8.0	Min. 12	VAR

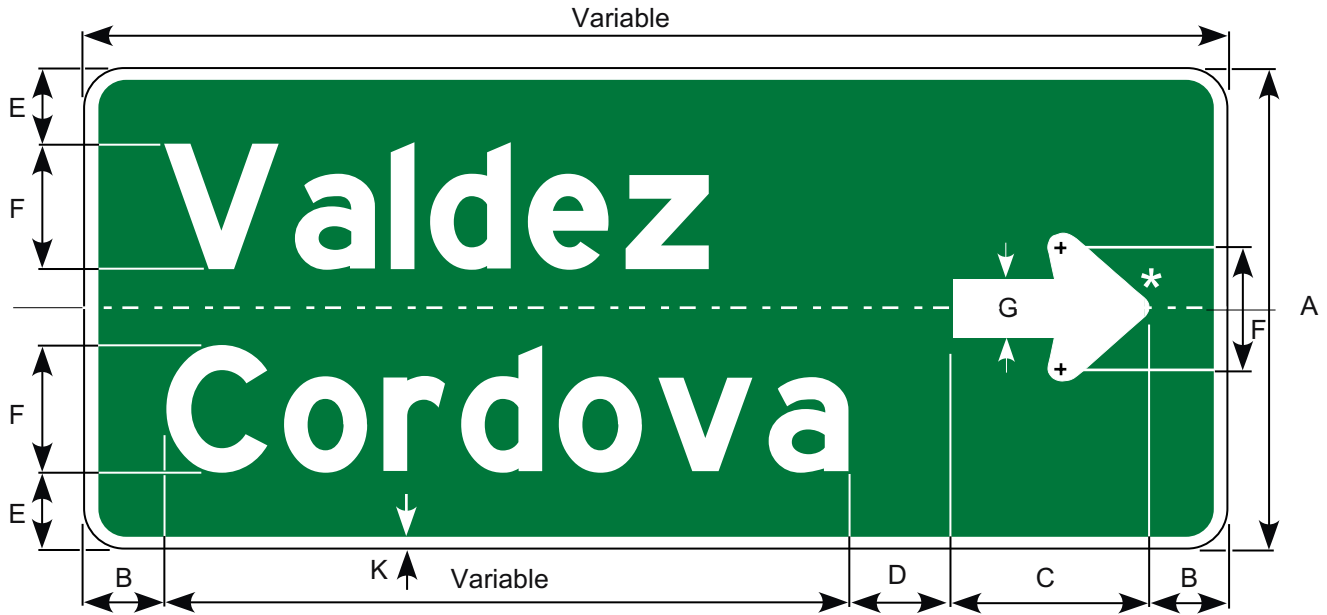

Border and Legend: White
Background: Green

*See Appendix B-1 for Standard Arrow Details.

Prior to the 2002 publication of this manual,
this sign was numbered D1-2.

Letter Size (inches)	Dimensions (inches)							
	A	B	C	D	E	F	G	K
6 / 4.5	24	6.0	9.56	6±	3.0	6.0	2.6	0.75
8 / 6	36	8.0	12.75	8±	7.0	8.0	3.48	1.0
10.7 / 8	48	11	17.25	11±	9.0	10.7	4.65	2.0
13.3 / 10	54	13	20.25	13±	9.5	13.3	5.78	2.0
16 / 12	66	16	25	16±	12	16	6.96	3.0

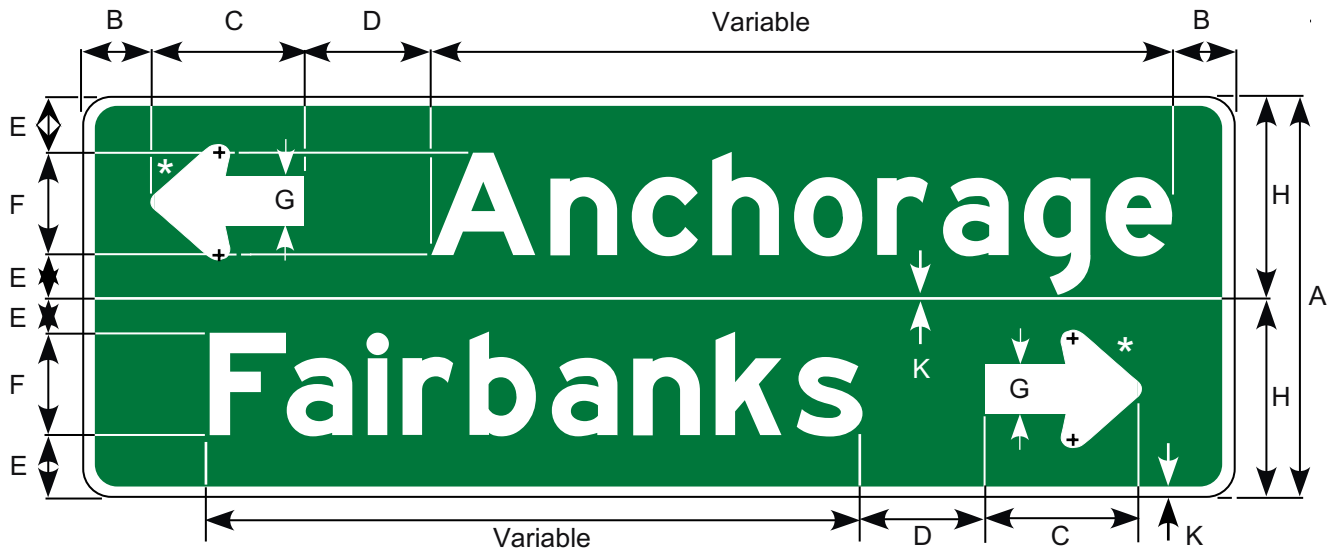

Border and Legend: White
Background: Green

*See Appendix B-1 or Standard Arrow Details.

Prior to the 2002 publication of this manual,
this sign was numbered D1-2.

Letter Size (inches)	Dimensions (inches)								
	A	B	C	D	E	F	G	H	K
6 / 4.5	24	6.0	9.56	6±	3.0	6.0	2.6	12	0.75
8 / 6	42	8.0	12.75	8±	6.25	8.0	3.48	21	1.0
10.7 / 8	54	11	17.25	11±	8.15	10.7	4.65	27	2.0
13.3 / 10	66	13	20.25	13±	9.85	13.3	5.78	33	2.0
16 / 12	78	16	25	16±	11.5	16	6.96	39	3.0

D1-2A-1

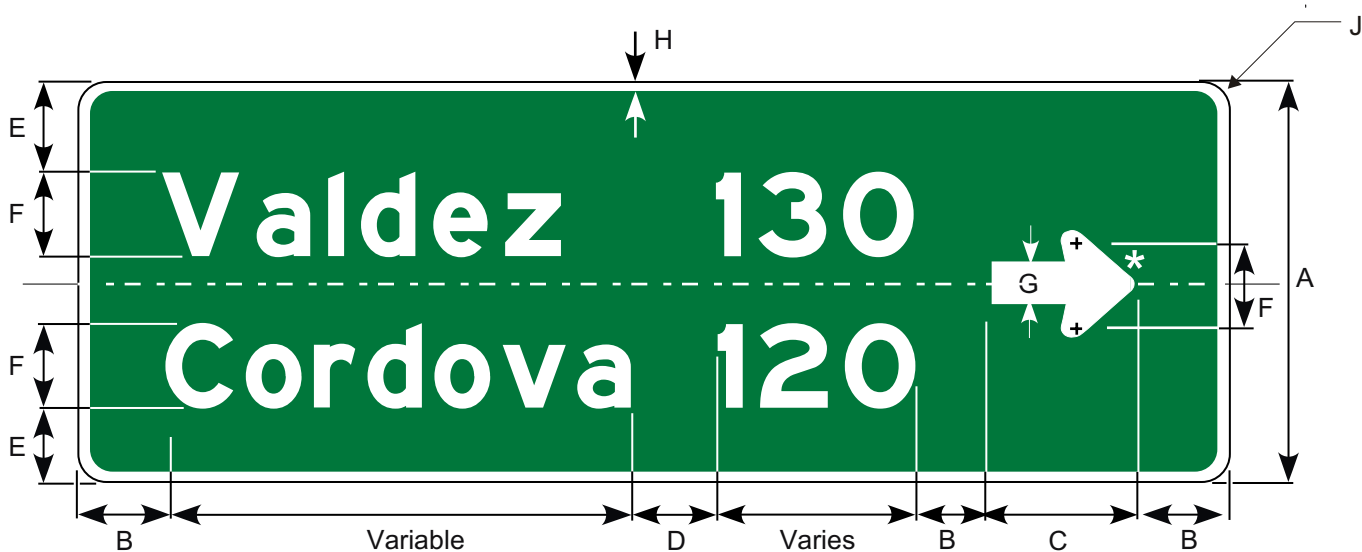

Border and Legend: White
Background: Green

*See Appendix B-1 for Standard Arrow Details.

Prior to the 2002 publication of this manual,
this sign was numbered D1-2A.

Letter Size (inches)	Dimensions (inches)								
	A	B	C	D	E	F	G	H	J
6 / 4.5	24	6.0	9.56	6±	4.0	6.0	2.6	0.75	1.5
8 / 6	36	8.0	12.75	8±	7.0	8.0	3.48	1.0	2.25
10.7 / 8	48	11	17.25	11±	9.0	10.7	4.65	2.0	3.0
13.3 / 10	54	13	20.25	13±	9.5	13.3	5.78	2.0	3.38
16 / 12	66	16	25	16±	12	16	6.96	3.0	4.13

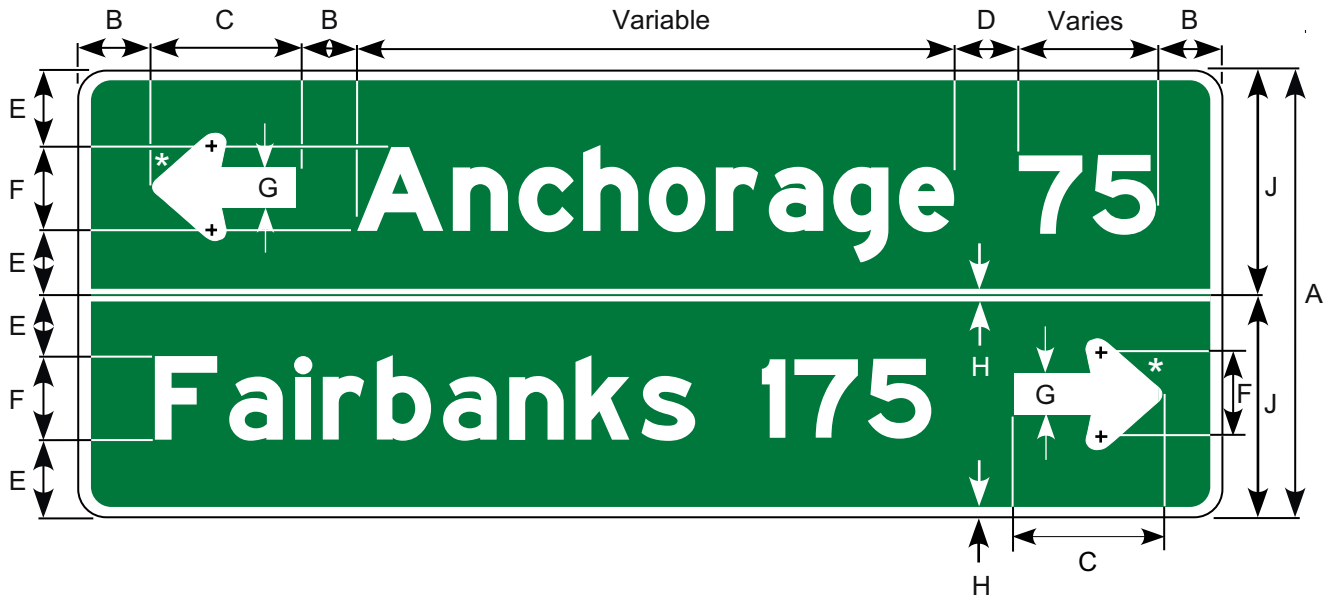

Border and Legend: White
Background: Green

*See Appendix B-1 for Standard Arrow Details.

Prior to the 2002 publication of this manual,
this sign was numbered D1-2A.

Letter Size (inches)	Dimensions (inches)								
	A	B	C	D	E	F	G	H	J
6 / 4.5	24	6.0	9.56	6±	4.0	6.0	2.6	0.75	12
8 / 6	42	8.0	12.75	8±	7.0	8.0	3.48	1.0	21
10.7 / 8	54	11	17.25	11±	9.0	10.7	4.65	2.0	27
13.3 / 10	66	13	20.25	13±	9.5	13.3	5.78	2.0	33
16 / 12	78	16	25	16±	12	16	6.96	3.0	39

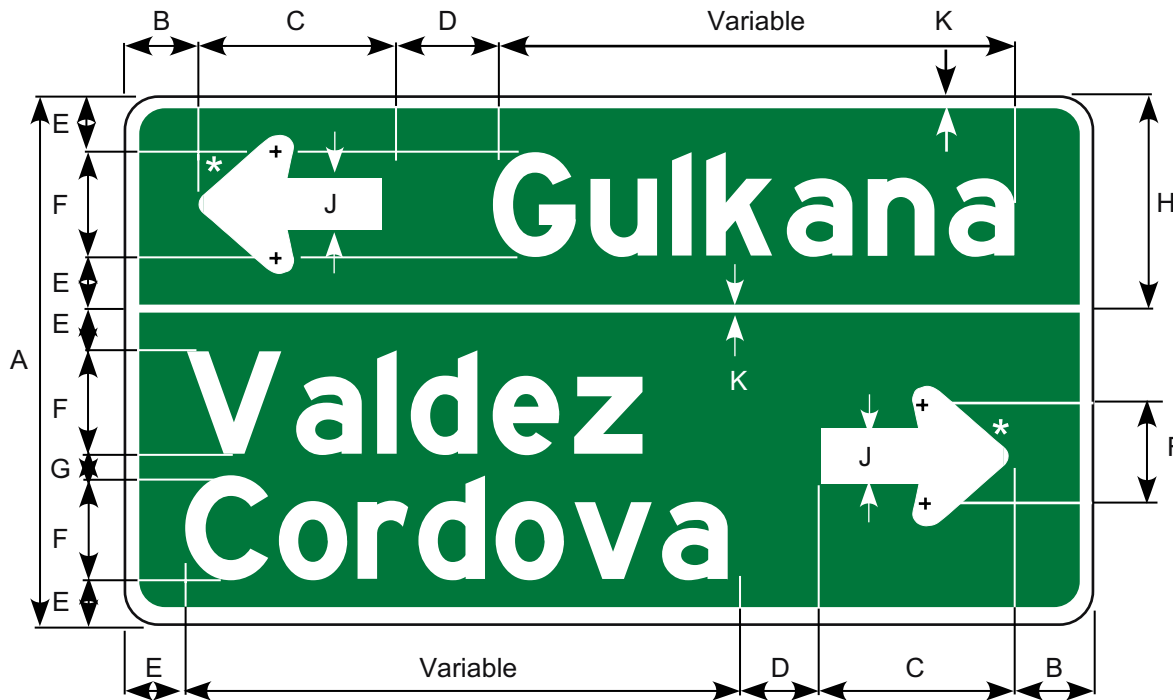

Border and Legend: White
Background: Green

*See Appendix B-1 for Standard Arrow Details.

Prior to the 2002 publication of this manual,
this sign was numbered D1-3.

Letter Size (inches)	Dimensions (inches)									
	A	B	C	D	E	F	G	H	J	K
6 / 4.5	36	6.0	9.56	6±	3.5	6.0	2.0	13.0	2.6	1.0
8 / 6	54	8.0	12.75	8±	6.0	8.0	6.0	20.0	3.48	1.25
10.7 / 8	72	11	17.25	11±	8.0	10.7	8.0	26.7	4.65	2.0
13.3 / 10	90	13	20.25	13±	10	13.3	10	33.3	5.78	3.0
16 / 12	108	16	25	16±	12	16	12	40	6.96	3.0

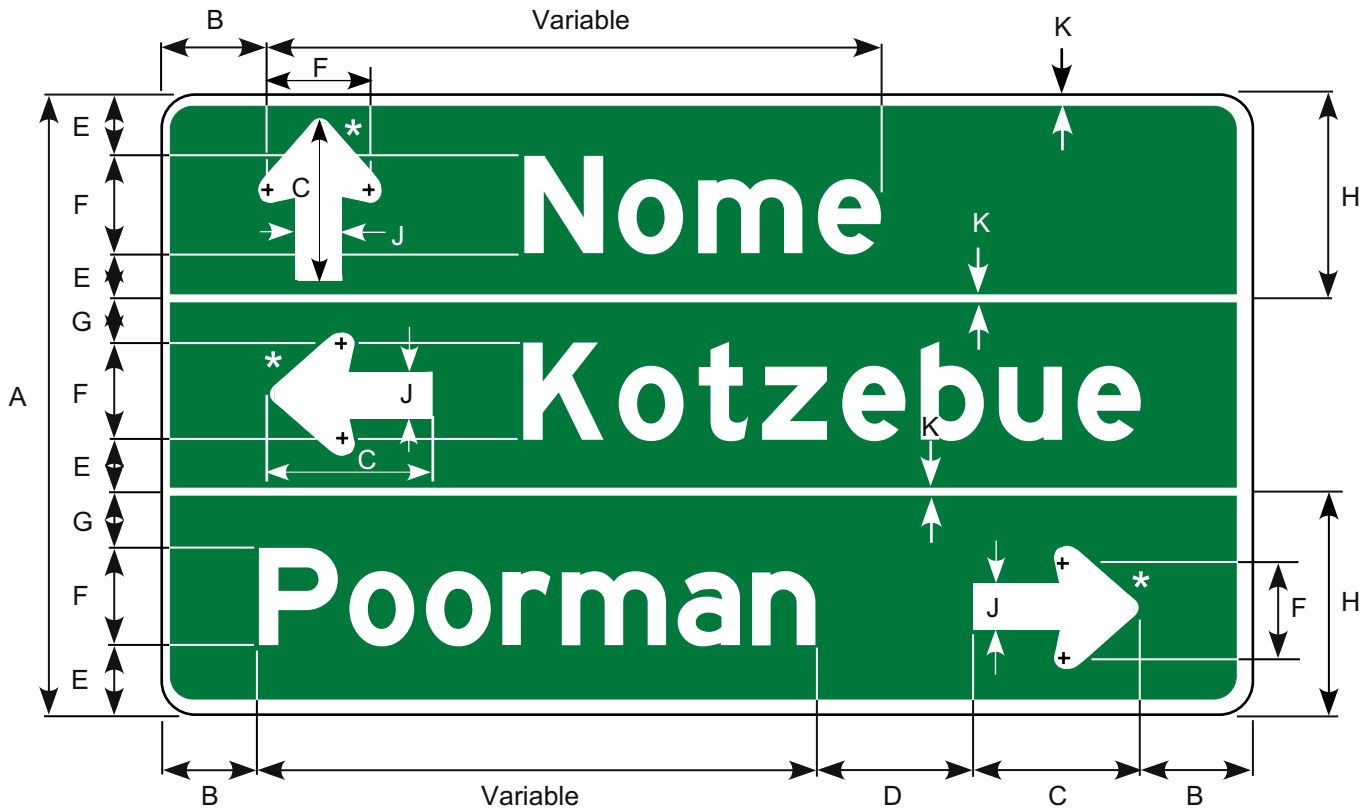

Border and Legend: White
Background: Green

*See Appendix B-1 for Standard Arrow Details.

Prior to the 2002 publication of this manual,
this sign was numbered D1-3.

Letter Size (inches)	Dimensions (inches)									
	A	B	C	D	E	F	G	H	J	K
6 / 4.5	42	6.0	9.56	6±	4.0	6.0	4.0	14	2.6	1.0
8 / 6	48	8.0	12.75	8±	6.0	8.0	6.0	16	3.48	1.25
10.7 / 8	78	11	17.25	11±	8.0	10.7	8.0	26.7	4.65	2.0
13.3 / 10	102	13	20.25	13±	10	13.3	11	33.3	5.78	3.0
16 / 12	120	16	25	16±	12	12	12	40	6.96	3.0

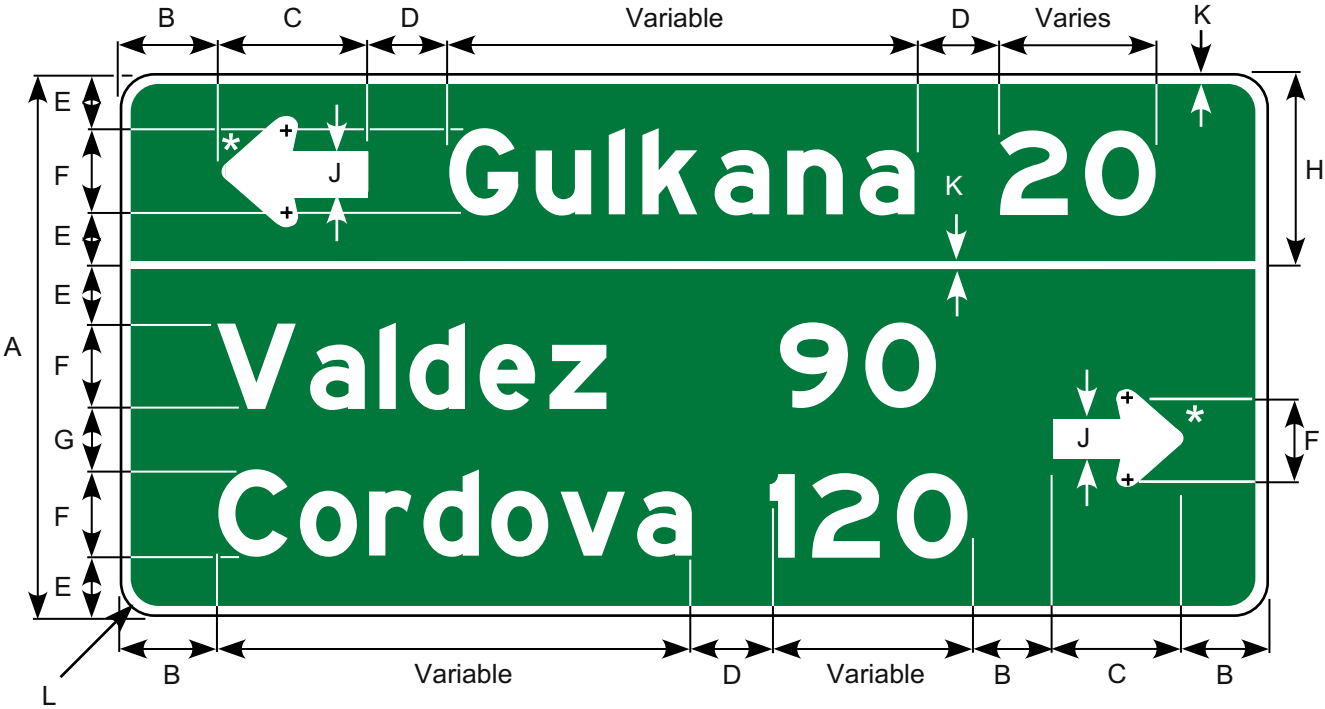

Border and Legend: White
 Background: Green

*See Appendix B-1 for Standard Arrow Details.

Prior to the 2002 publication of this manual,
 this sign was numbered D1-3A.

Letter Size (inches)	Dimensions (inches)									
	A	B	C	D	E	F	G	H	K	L
6 / 4.5	36	6±	9.56	9	3.5	6.0	4.0	13	1.0	2.25
8 / 6	54	8±	12.75	12	6.0	8.0	6.0	20	1.25	3.38
10.7 / 8	72	11±	17.25	16	8.0	10.7	8.0	26.7	2.0	4.0
13.3 / 10	90	13±	20.25	20	10	13.3	10	33.3	3.0	4.0
16 / 12	108	16±	25	24	12	16	12	40	3.0	4.0

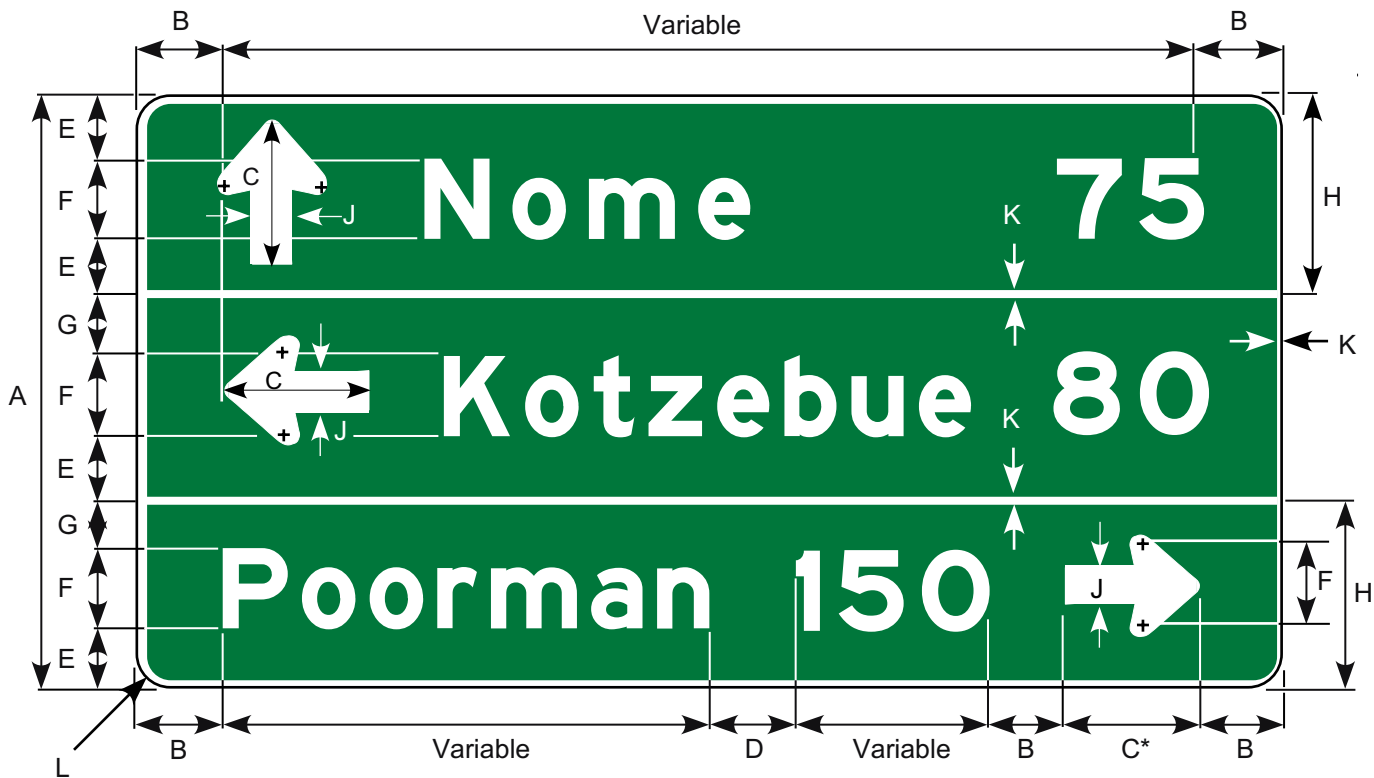

Border and Legend: White
Background: Green

See Appendix B-1 for Standard Arrow Details.

Prior to the 2002 publication of this manual,
this sign was numbered D1-3A.

Letter Size (inches)	Dimensions (inches)										
	A	B	C	D	E	F	G	H	J	K	L
6 / 4.5	42	6±	9.56	9	4.0	6.0	4.0	14	2.6	1.0	2.6
8 / 6	48	8±	12.75	12	6.0	8.0	6.0	16	3.48	1.25	3.0
10.7 / 8	78	11±	17.25	16	8.0	10.7	8.0	26.7	4.65	2.0	4.0
13.3 / 10	102	13±	20.25	20	10	13.3	11	33.3	5.78	3.0	4.0
16 / 12	120	16±	25	24	12	12	12	40	6.96	3.0	4.0

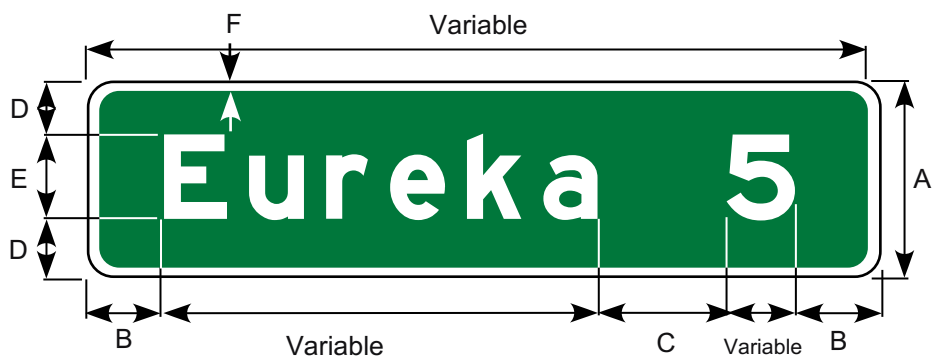

Border and Legend: White
Background: Green

Letter Size (inches)	Dimensions (inches)					
	A	B	C	D	E	F
6 / 4.5	12	4±	9.0	3.0	6.0	0.63
8 / 6	18	6±	12	5.0	8.0	0.75
10.7 / 8	24	8±	16	6.65	10.7	1.25
13.3 / 10	30	10±	20	8.35	13.3	2.0
16 / 12	36	12±	24	10	16.0	2.0

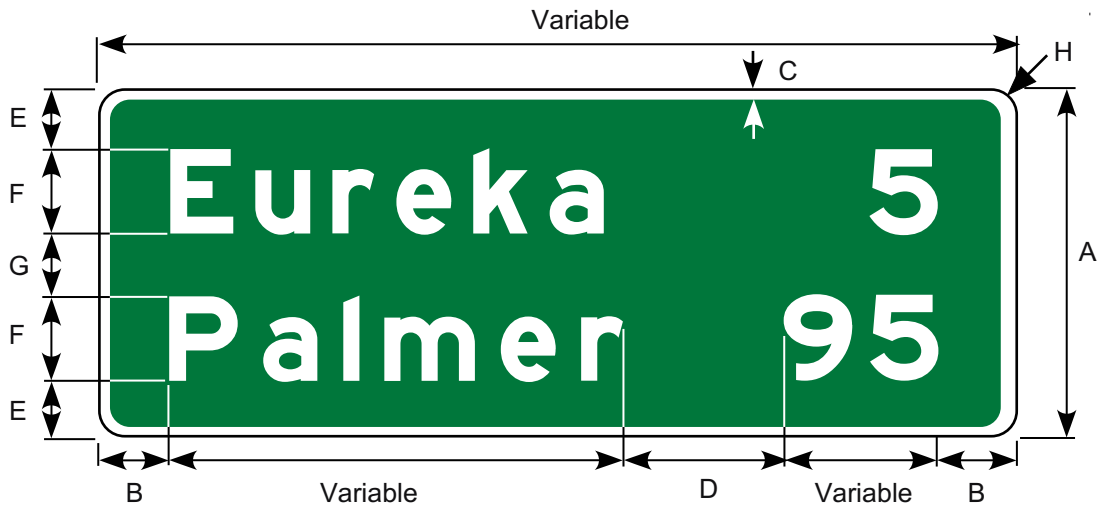

Border and Legend: White
 Background: Green

Letter Size (inches)	Dimensions (inches)							
	A	B	C	D	E	F	G	H
6 / 4.5	24	6±	0.63	9.0	4.0	6.0	4.0	1.5
8 / 6	36	8±	0.75	12	7.0	8.0	6.0	2.25
10.7 / 8	48	11±	1.25	16	9.0	10.7	8.6	3.0
13.3 / 10	54	13±	2.0	20	9.5	13.3	8.4	3.38
16 / 12	66	16±	2.0	24	12	16	10	4.0

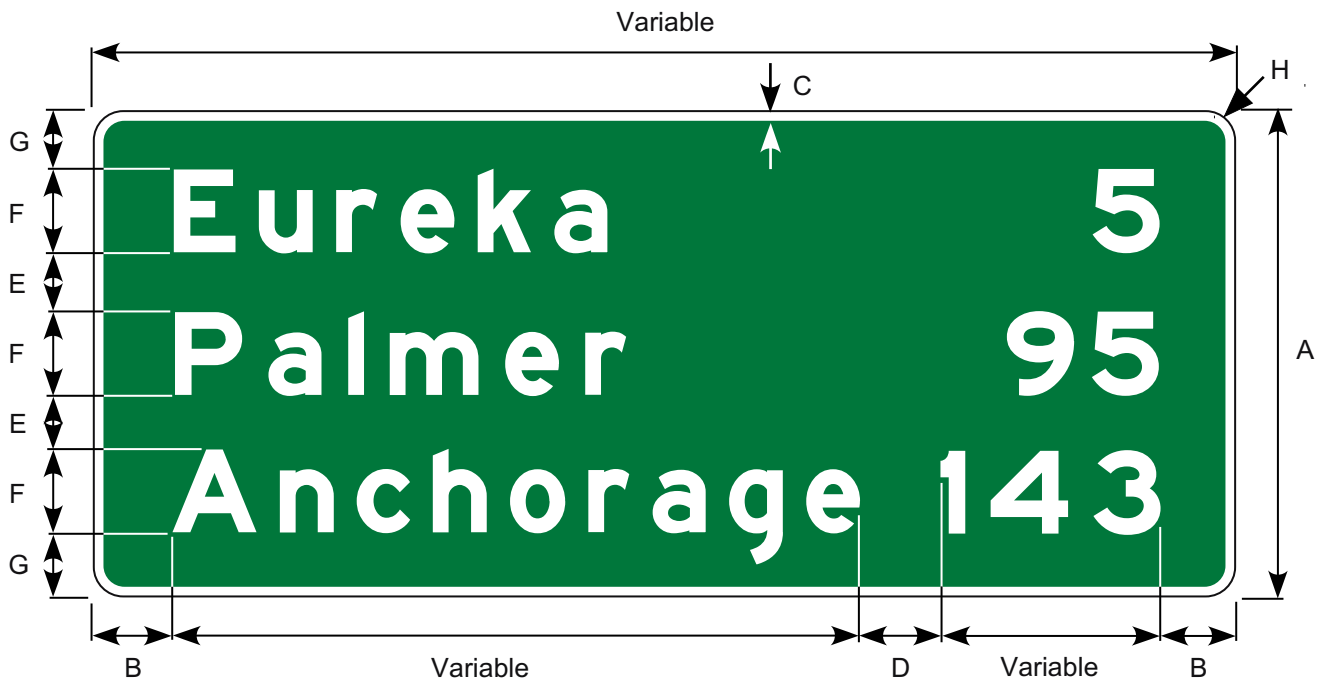

Border and Legend: White
Background: Green

Letter Size (inches)	Dimensions (inches)							
	A	B	C	D	E	F	G	H
6 / 4.5	36	6±	1.0	9.0	4.0	6.0	5.0	2.25
8 / 6	48	8±	1.25	12	5.0	8.0	7.0	3.0
10.7 / 8	66	11±	2.0	16	7.0	10.7	10	4.0
13.3 / 10	78	13±	2.0	20	9.0	13.3	10	4.0
16 / 12	96	16±	3.0	24	11	16.0	13	4.0

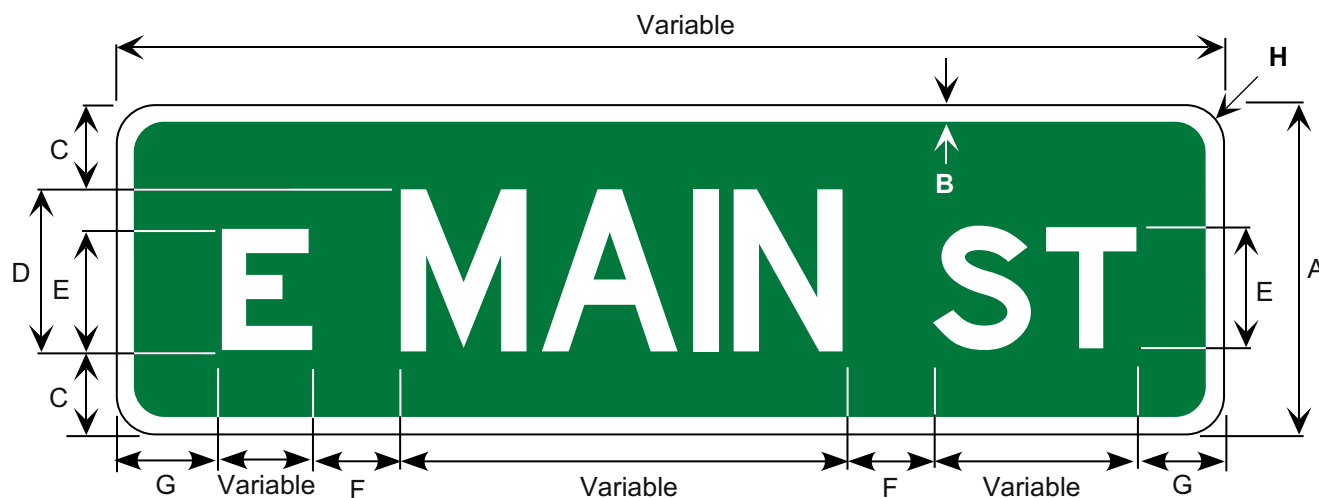

Border and Legend: White
Background: Green

* Letters may be series B, C, or D.

Road Class	Dimensions (inches)							
	A	B	C	D	E	F	G	H
Local Rds w Spd Limits <= 25MPH or STOP Condition	8	0.50	2.0	4*	3*	3.5	3±	1.5
All Other Roads	12	0.50	3.0	6*	4*	5.0	4±	1.5

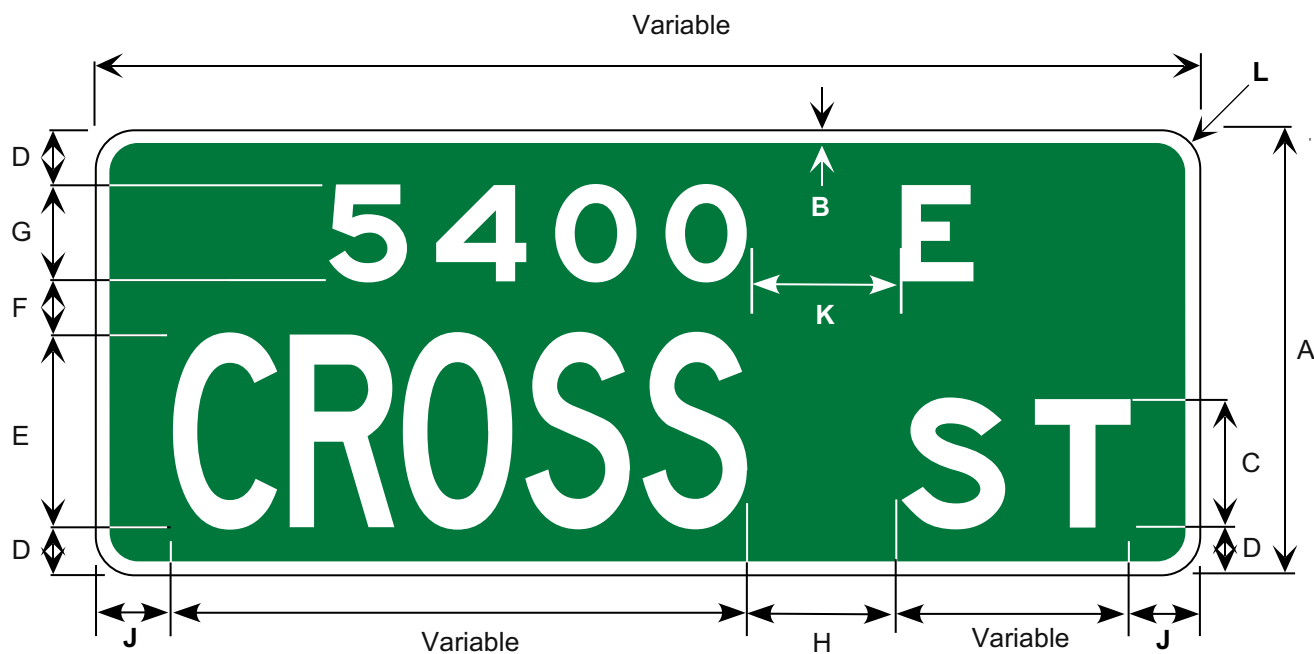

Border and Legend: White
Background: Green

* Letters may be series B, C, or D.

Letter Size (Inches)	Dimensions										
	A	B	C	D	E	F	G	H	J	K	L
6/4	14	0.5	4*	1.5	6*	2.0	3.0	5.0	3±	4.5	1.5

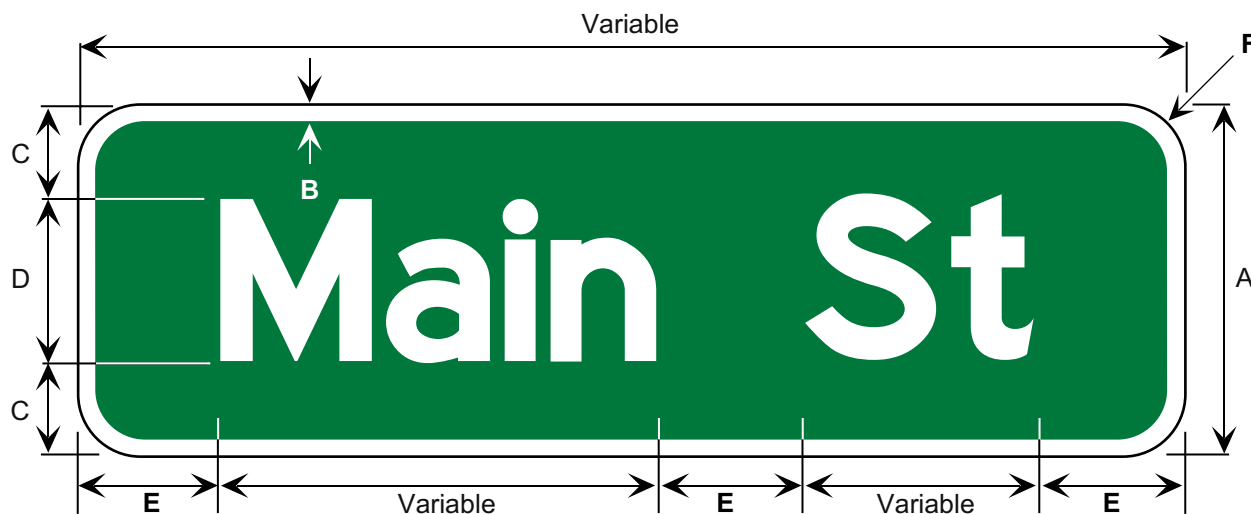

Border and Legend: White
Background: Green

For Overhead Mounting Only

Letter Size (inches)	Dimensions (inches)					
	A	B	C	D	E	F
8 / 6	18	0.50	5.0	8.0	8±	2.25
10.7 / 8	30	0.75	9.65	10.7	11±	3.75
13.3 / 10	36	1.5	11.3	13.3	13±	4.5

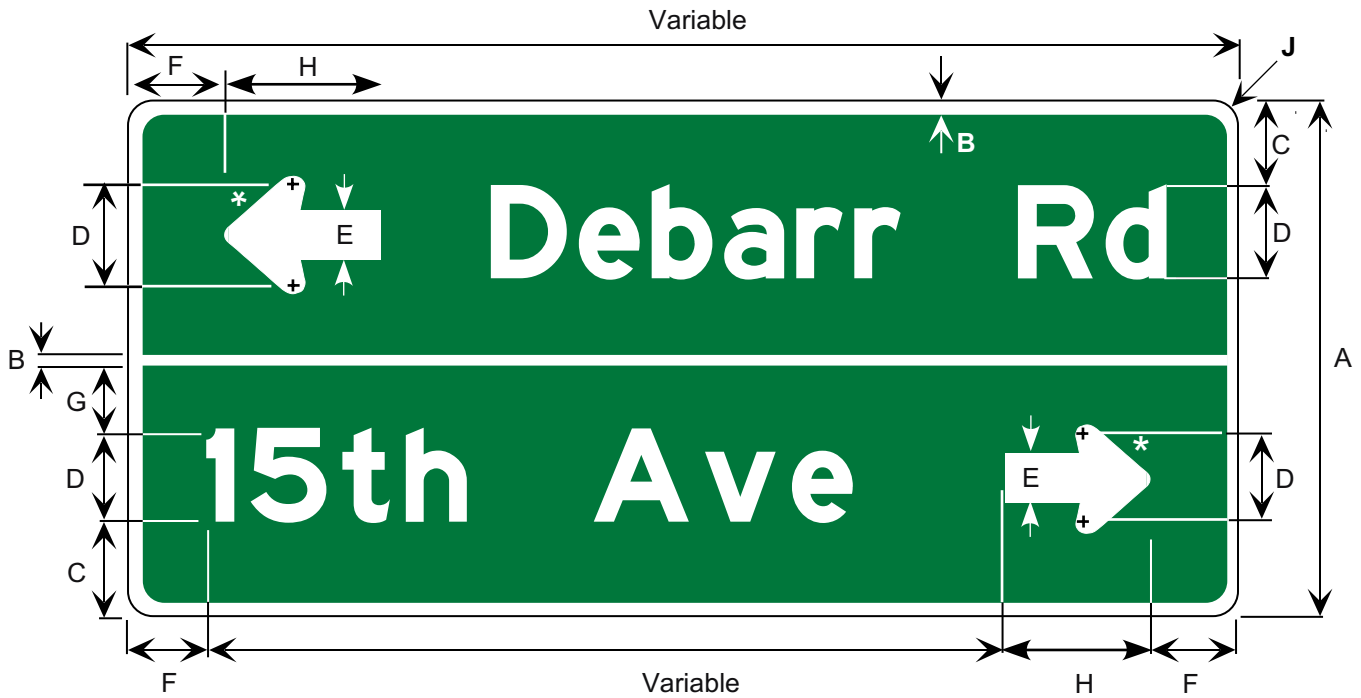

Border and Legend: White
Background: Green

*See Appendix B-1 for Arrow Details.

Letter Size (inches)	Dimensions (inches)								
	A	B	C	D	E	F	G	H	J
6 / 4.5	24	0.75	3.0	6.0	2.6	6±	2.63	9.56	1.5
8 / 6	42	1.0	6.25	8.0	3.48	8±	6.25	12.75	2.5
10.7 / 8	54	1.25	8.15	10.7	4.65	11±	7.5	17.25	3.5
13.3 / 10	66	1.5	9.85	13.3	5.78	13±	9.1	20.25	4.0

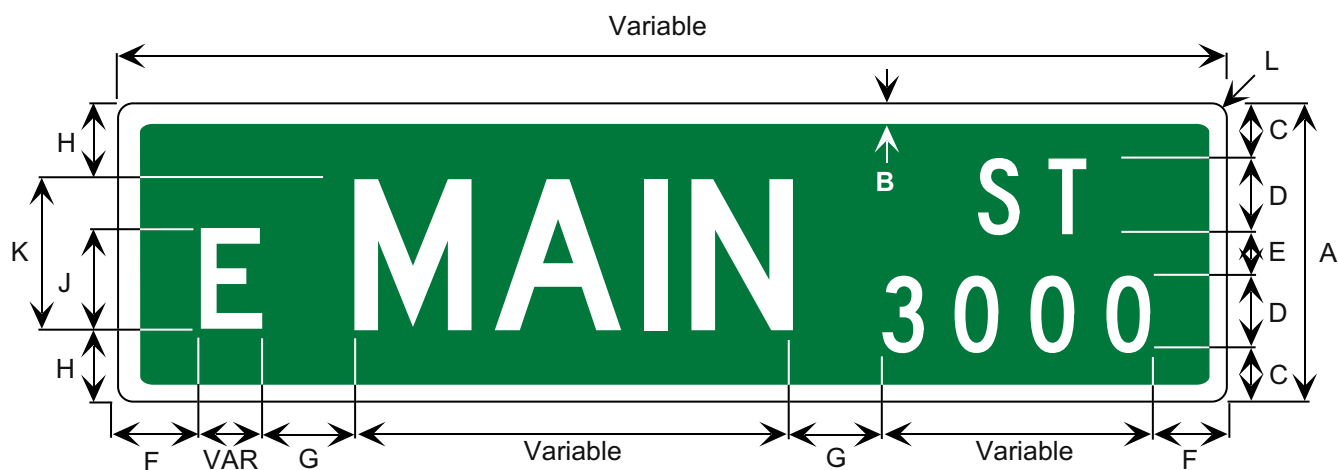

Border and Legend: White
Background: Green

* Letters may be series B, C, or D.

Road Class	Dimensions (inches)										
	A	B	C	D	E	F	G	H	J	K	L
Local Rds w Spd Limits <= 25MPH or Stop Condition	8	0.50	1.5	2*	1.0	3±	3.5	2.0	3*	4*	1.5
All Other Roads	12	0.50	2.0	3*	2.0	4.5±	5.0	3.0	4*	6*	1.5

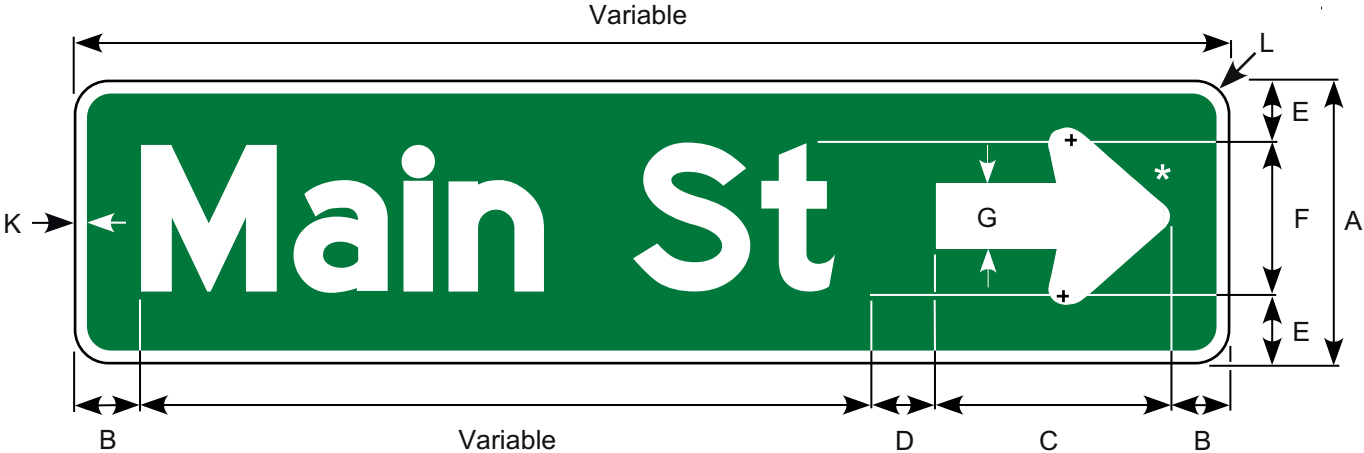

D3-2R

Border and Legend: White
Background: Green

*See Appendix B-1 for Standard Arrow Details.
*Arrow may be omitted



D3-2L

Letter Size (inches)	Dimensions (inches)								
	A	B	C	D	E	F	G	K	L
6 / 4.5	12	6±	9.56	6±	3.0	6.0	2.6	0.63	1.5
8 / 6	24	8±	12.75	8±	8.0	8.0	3.48	0.75	1.5
10.7 / 8	24	11±	17.25	11±	6.65	10.7	4.65	1.25	1.88
13.3 / 10	36	13±	20.25	13±	11.35	13.3	5.78	2.0	2.25
16 / 12	36	16±	25	16±	10	16	6.96	2.0	2.63

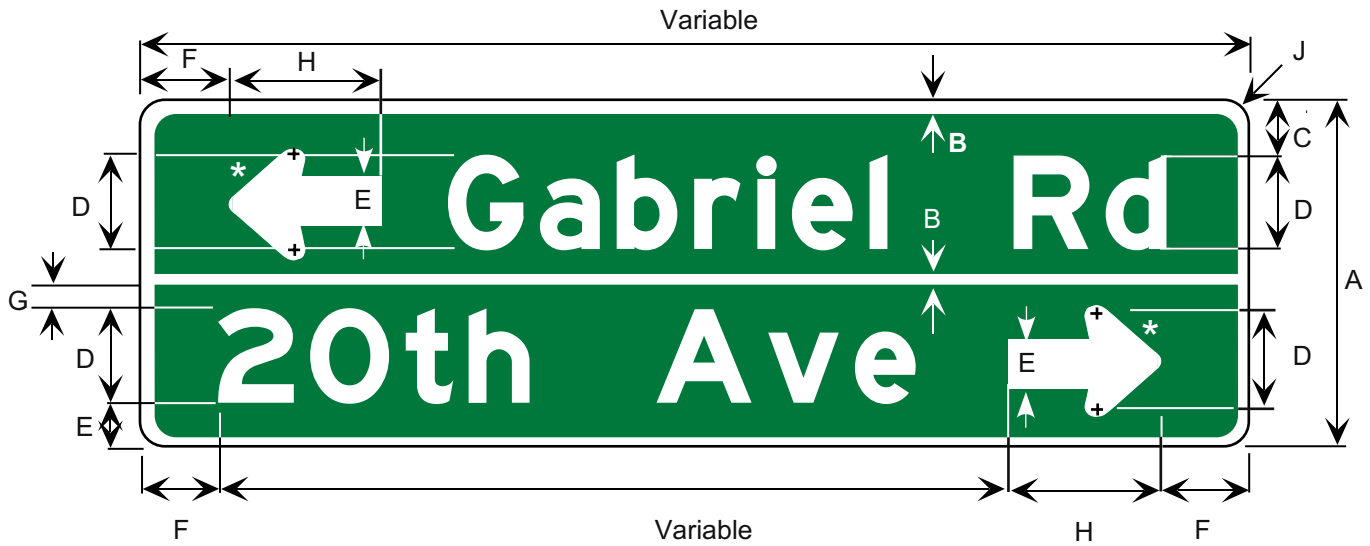

Border and Legend: White
Background: Green

For Overhead Mounting Only

* See Appendix B-1 for Standard Arrow Details.

Letter Size (inches)	Dimensions (inches)									
	A	B	C	D	E	F	G	H	J	
8 / 6	30	1.0	3.5	8E	4.0	8±	2.5	12.75	2.5	

D3-2C

D3-2D

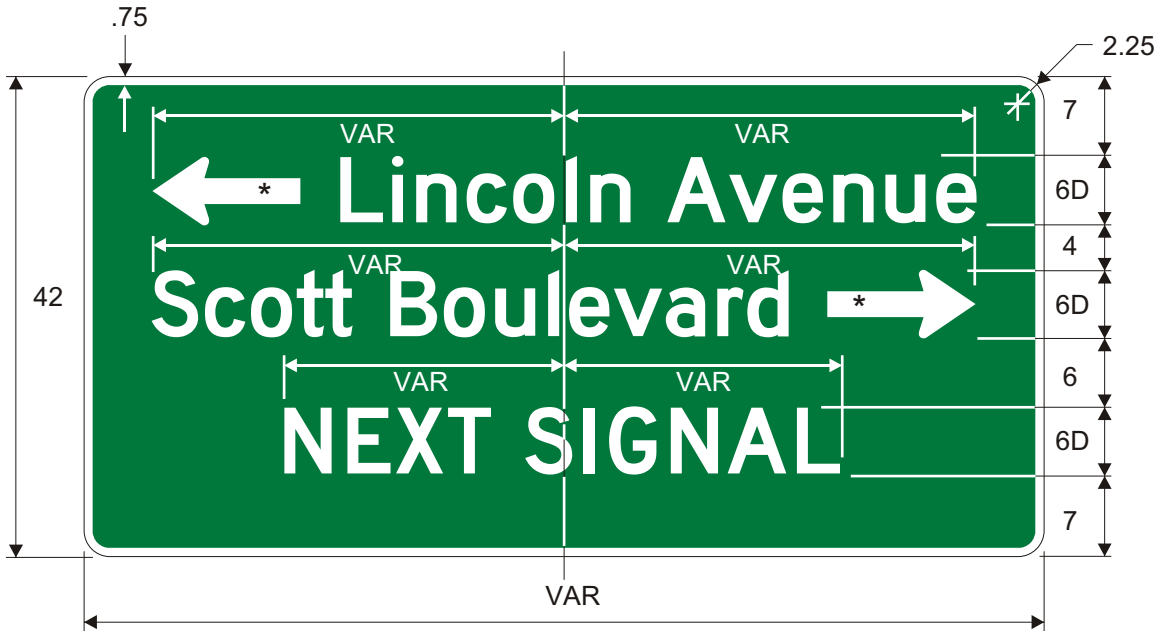

D3-2C

*See Appendix B-1 for Standard Arrow Details.

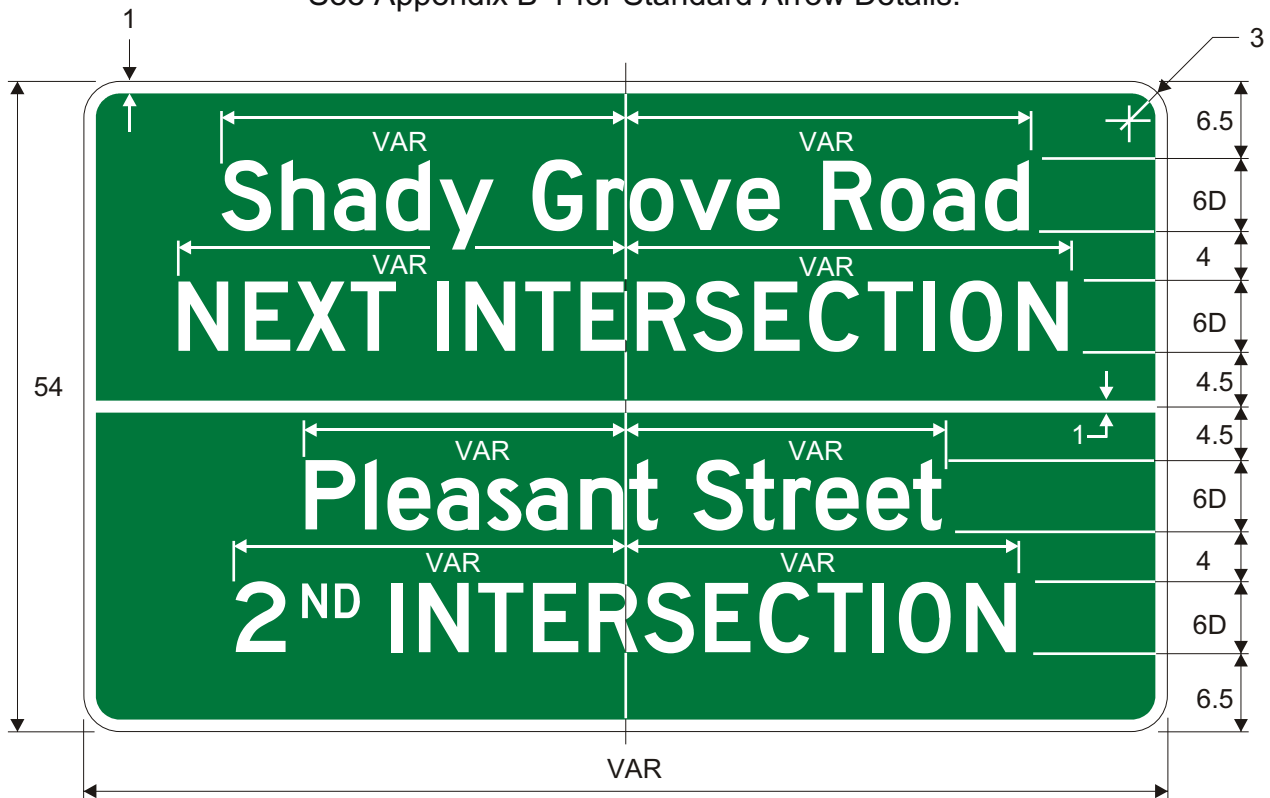

D3-2D

Border and Legend: White
Background: Green

DESTINATION SIGNS - PARKING AREA

D4-1 to D4-100



*See Appendix B-1 for standard arrow details.

Border and Legend: Green
Background: White

*Rotate arrow 45 degrees

Road Class	Dimensions (inches)											
	A	B	C	D	E	F	G	H	J	K	L	M
Conv & Min	30	24	0.38	0.63	15E	4.5	3E	10.13	2.5	9	1.5	7.25

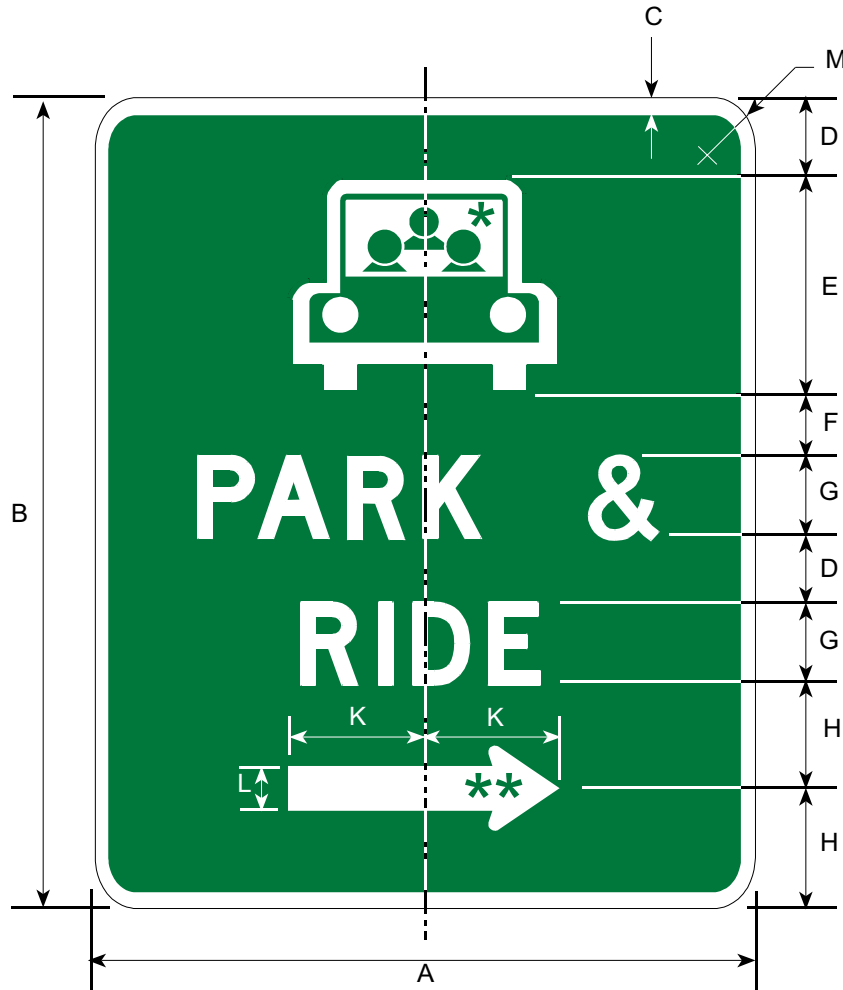

* Make symbol proportional to graphic shown.

Border and Legend: White
Background: Green

Center car symbol if no transit symbol is used.

** See Appendix B-1 for standard arrow details.

Road Class	Dimensions (inches)										
	A	B	C	D	E	F	G	H	K	L	M
Minimum	24	30	0.63	2.0	8.0	3.0	3D	4.5	6.0	1.13	1.5
Conventional	30	36	0.75	3.0	9.0	3.0	4D	5.0	7.0	1.50	1.88
Expressway	36	48	0.88	4.0	11	3.0	6D	7.0	9.0	2.25	2.25

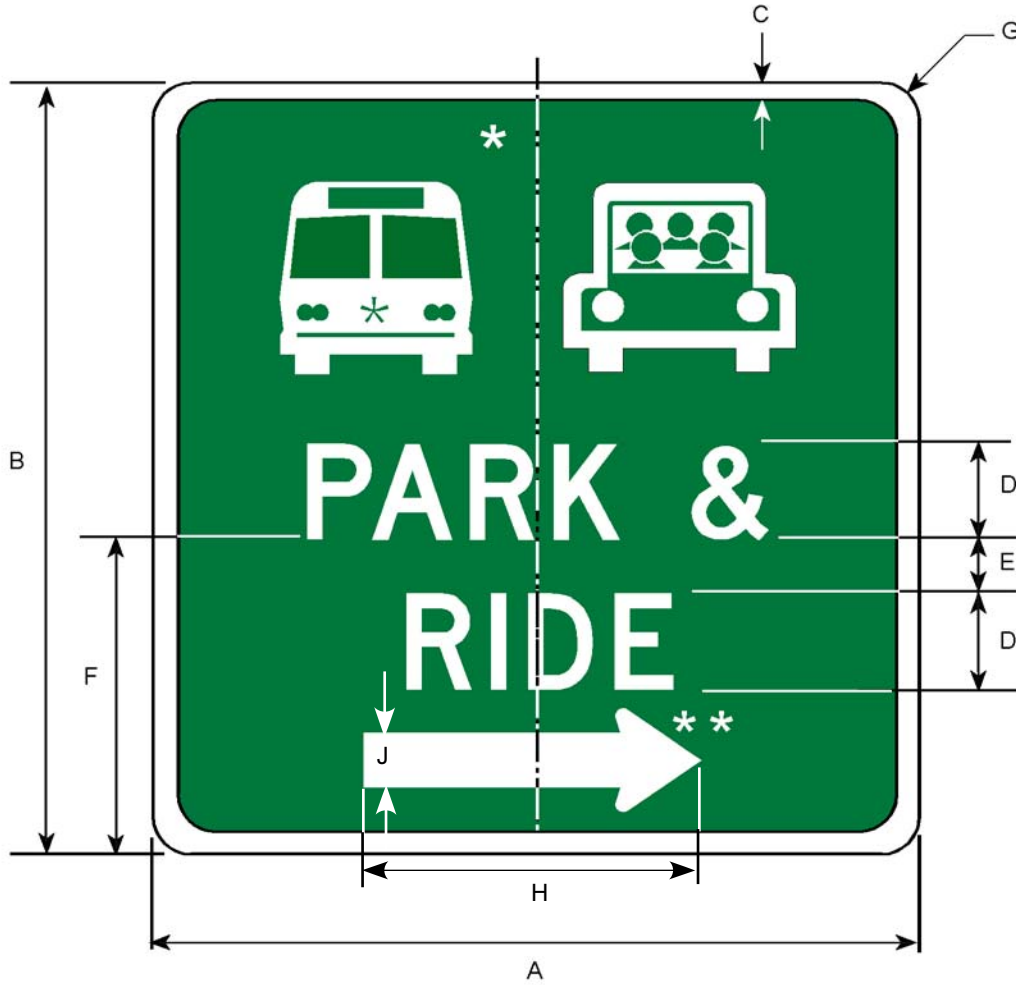

*Make symbol proportional to graphic shown.

Border and Legend: White
Background: Green

**See Appendix B-1 for standard arrow details.

Road Class	Dimensions (inches)									
	A	B	C	D	E	F	G	H	J	
Conv & Min	24	24	0.63	3D	2	12	1.5	12	1.13	

DESTINATION SIGNS - REST AREA

D5-1 to D5-104

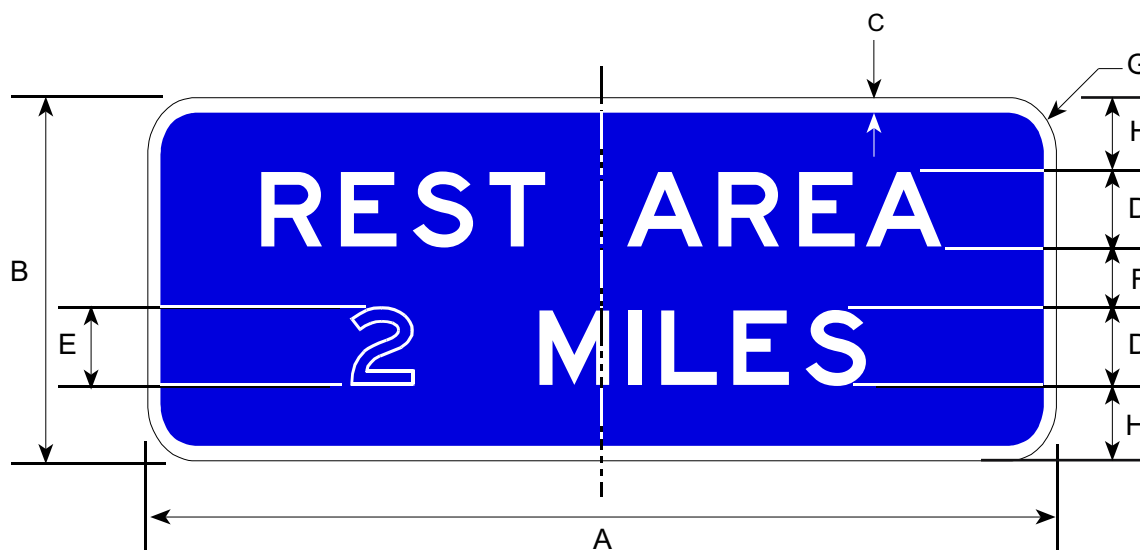

Border and Legend: White
 Background: Blue

Road Class	Dimensions (inches)							
	A	B	C	D	E	F	G	H
Minimum	96	36	1.5	8E	10	5.5	4	7.25
Conventional	120	48	2.0	10E	12	8.0	6	10.00
Expressway	144	60	2.0	12E	15	10.5	6	12.75

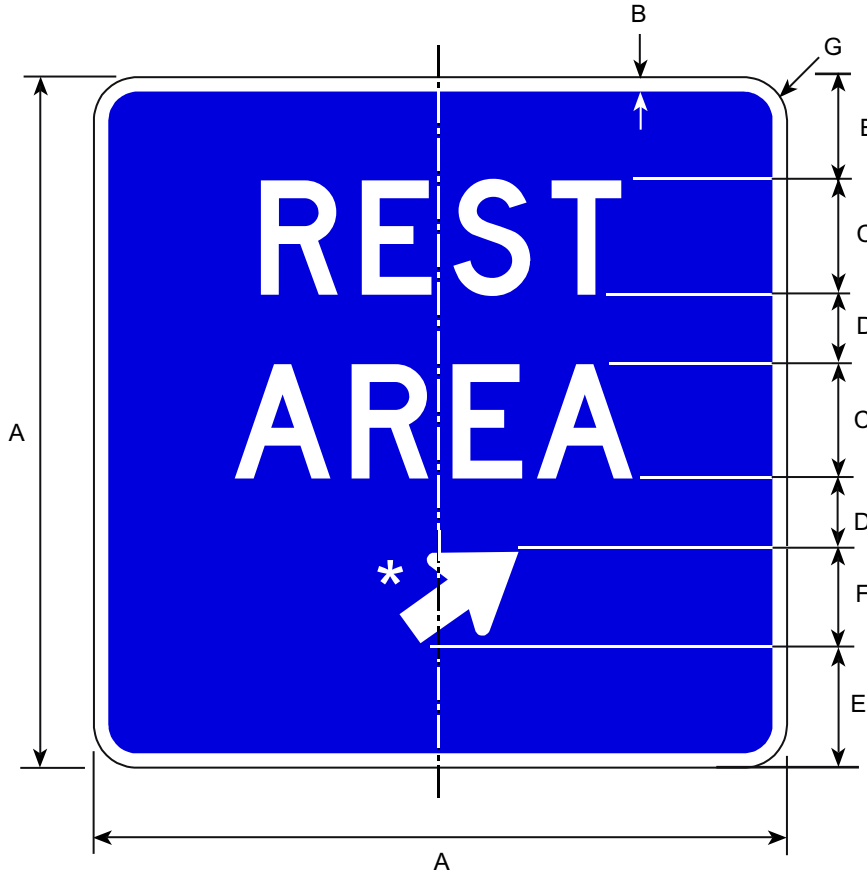

*See Appendix B-4 for Arrow Details.
*Tilt Arrow 30°.

Border and Legend: White
Background: Blue

Prior to the 2002 publication of this manual, this sign was numbered I-21.

Road Class	Dimensions (inches)						
	A	B	C	D	E	F	G
Minimum	48	1.5	8D	4	6.56	9.88 (Arw No. 1)	4
Conventional	60	2.0	10D	5	6.81	16 (Arw No. 3)	6
Expressway	72	2.0	12D	6	7.88	17.75 (Arw No. 5)	6

D5-3
D5-3C

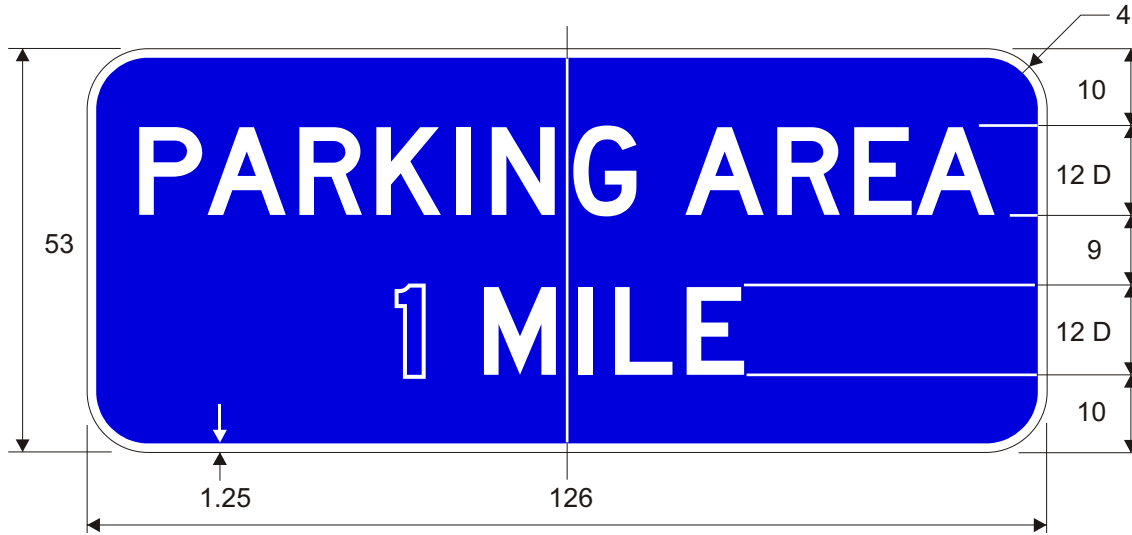

D5-3

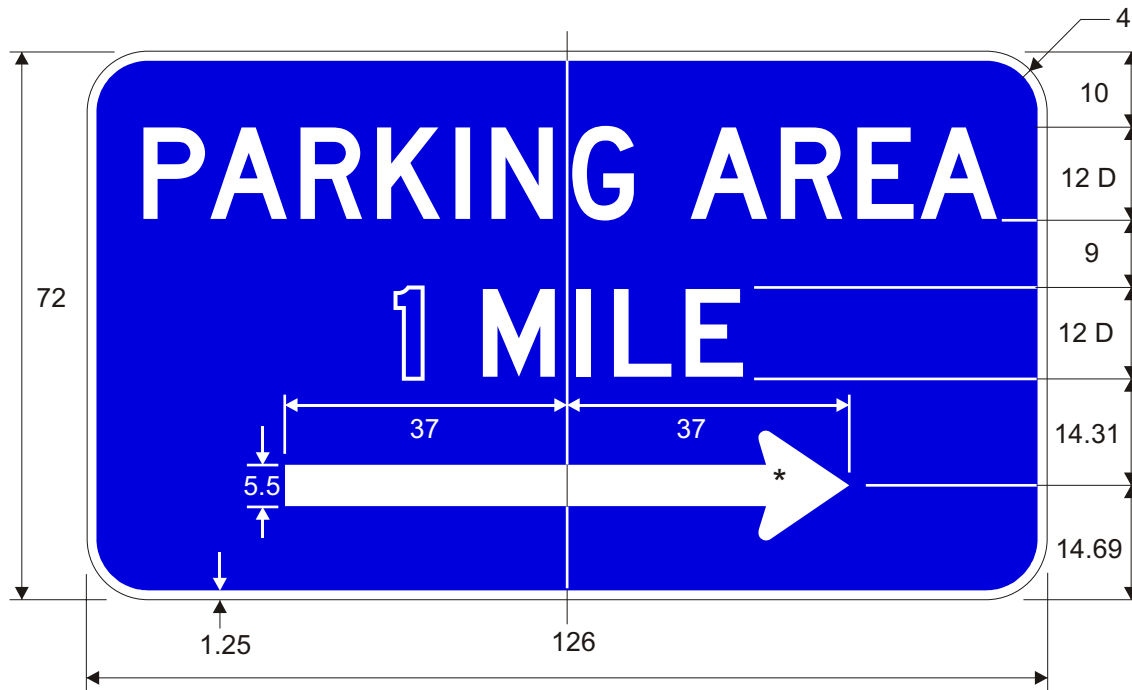

D5-3C

* See Appendix B-1 for standard arrow details.

Border and Legend: White
Background: Blue

D5-4

D5-5

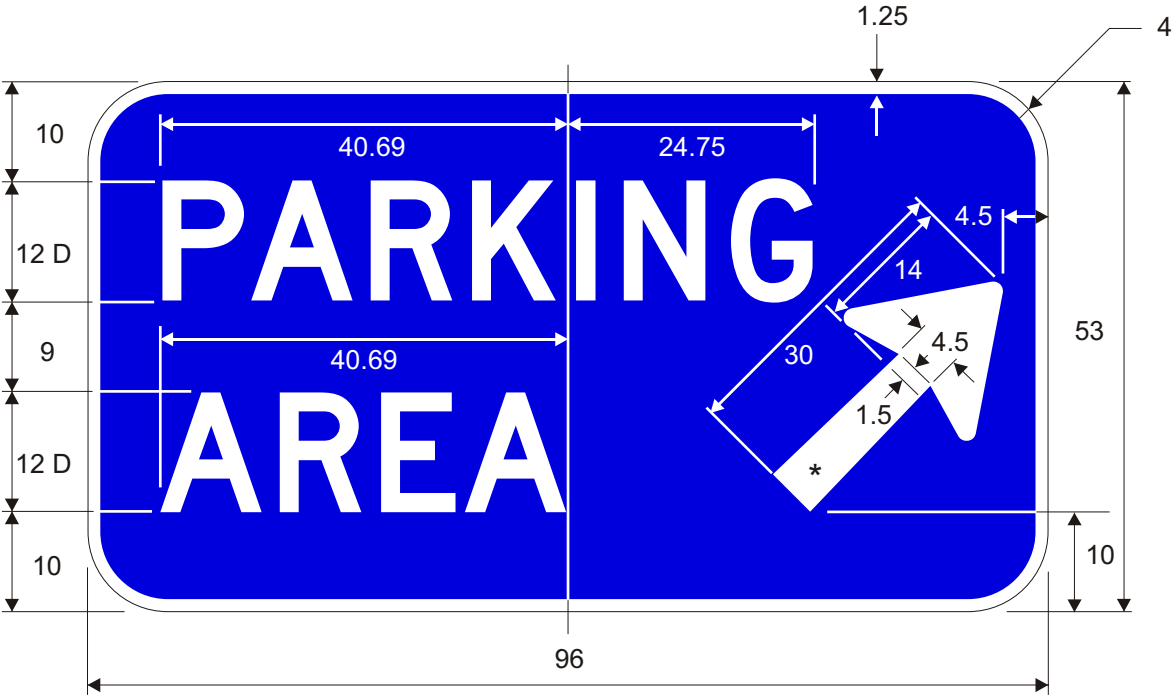

D5-4

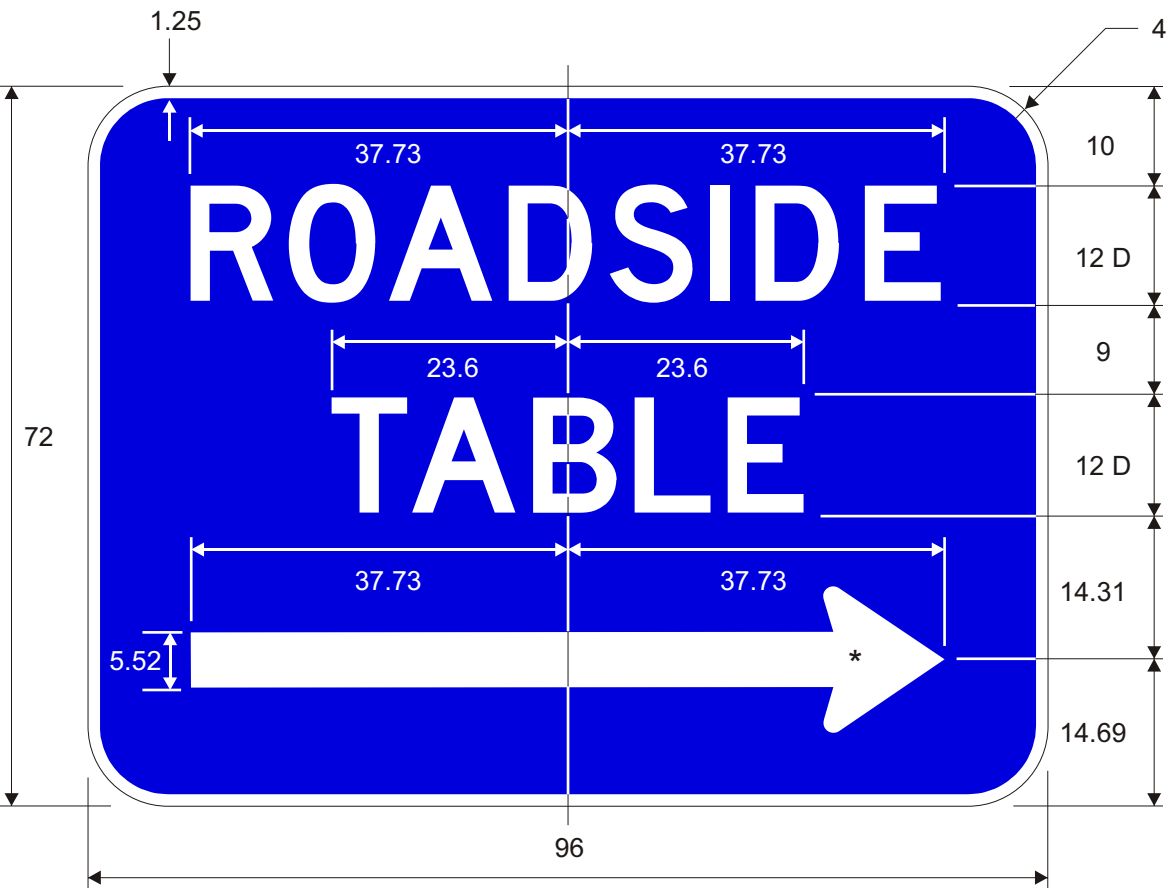

D5-5

Border and Legend: White
Background: Blue

* See Appendix B-1 for Standard Arrow Details.

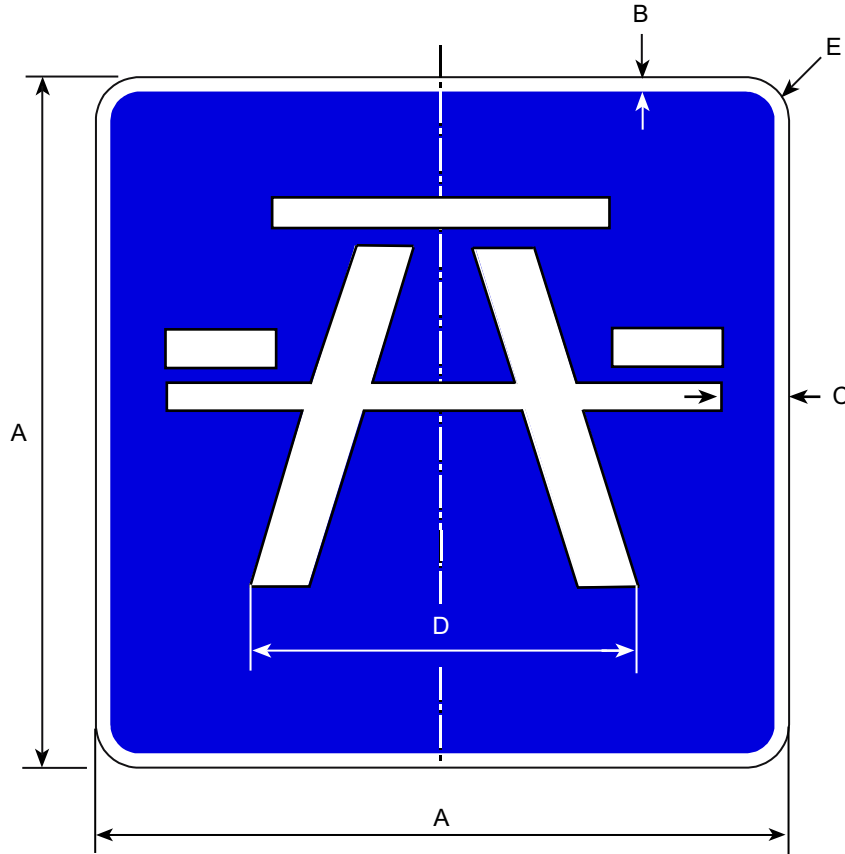

Border and Legend: White
Background: Blue

Road Class	Dimensions (inches)				
	A	B	C	D	E
Minimum	18	0.50	1.5	15	1.5
Conventional	24	0.50	2.0	20	1.5
Expressway	30	0.75	2.5	25	1.88

D5-5B
D5-5C

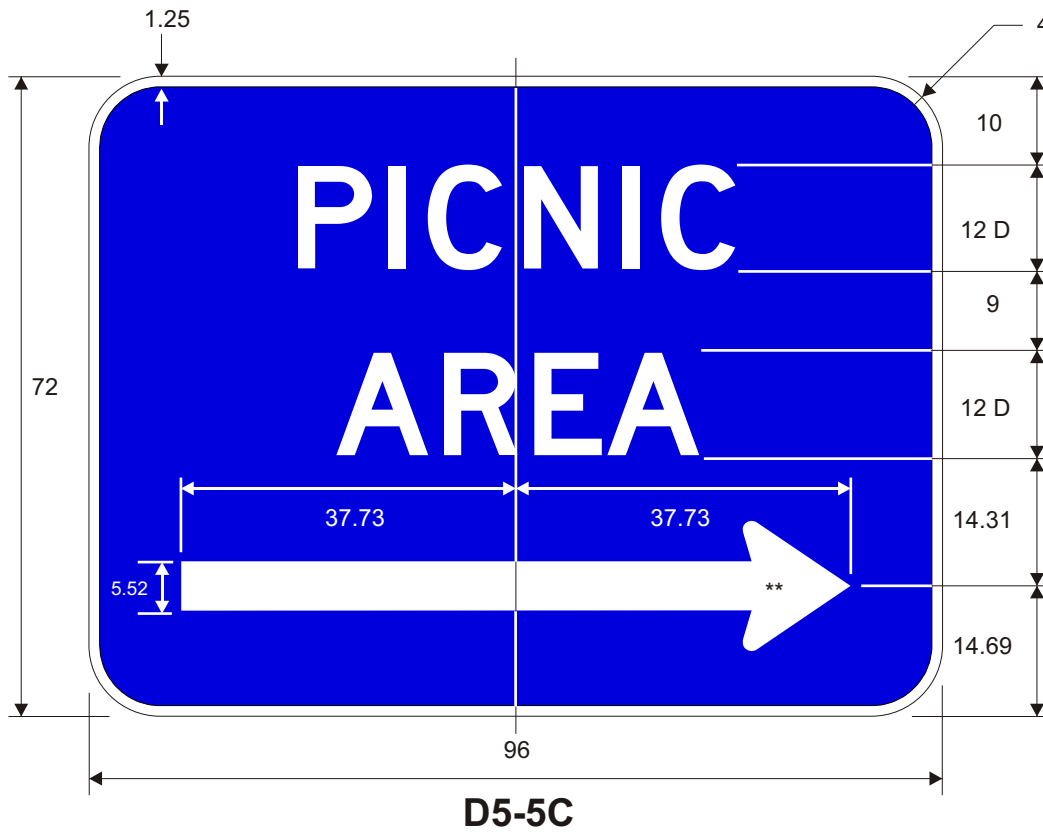
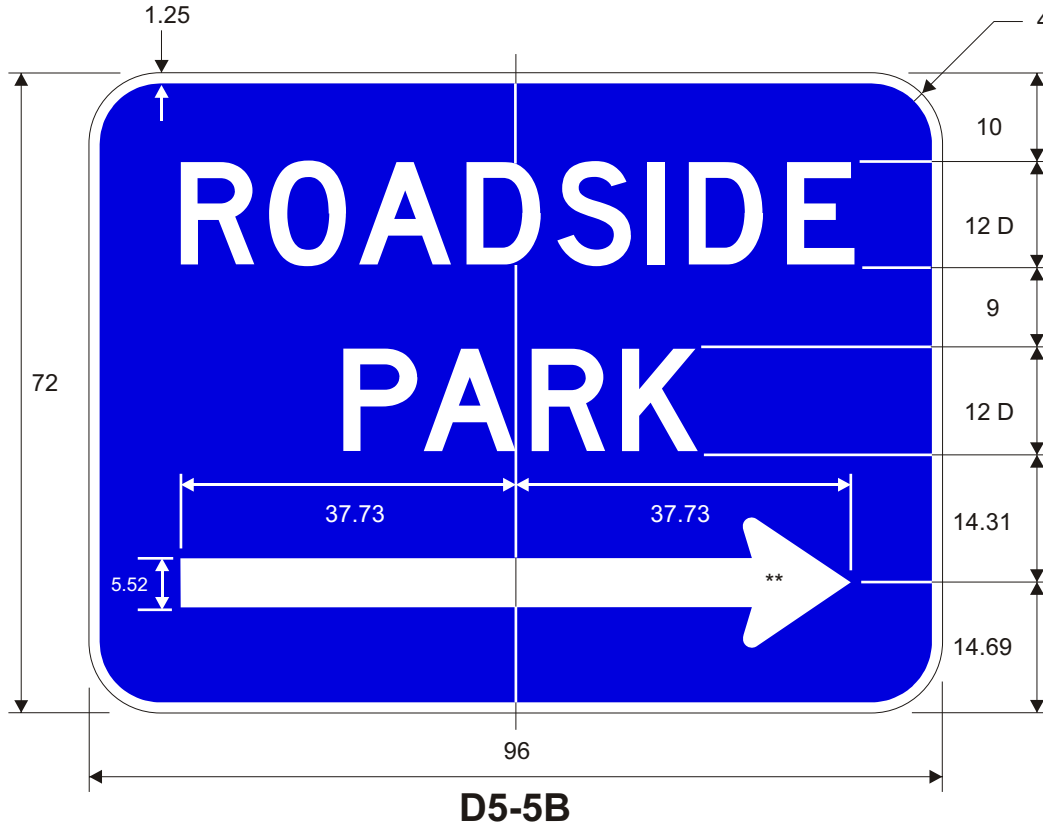

Border and Legend: White
Background: Blue

* See Appendix B-1 for Standard Arrow Details.

D5-5D

D5-5E

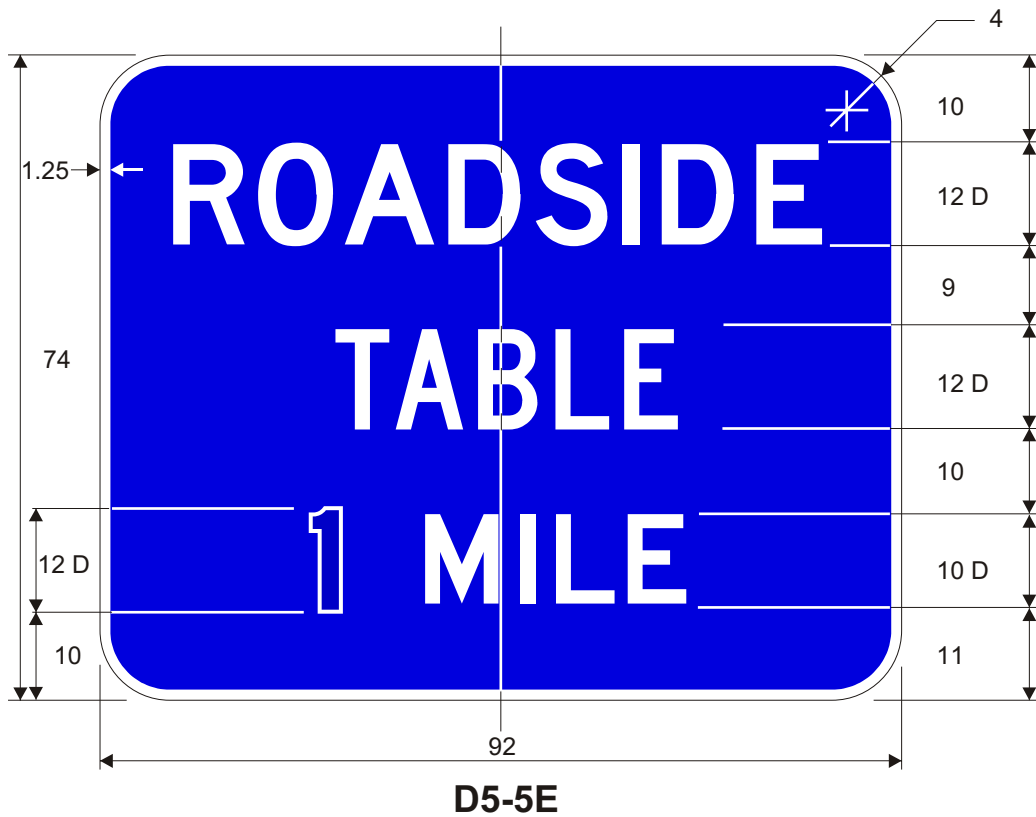

Border and Legend: White
Background: Blue



Border and Legend: White
Background: Blue

D5-7
D5-7A



*Optically Center

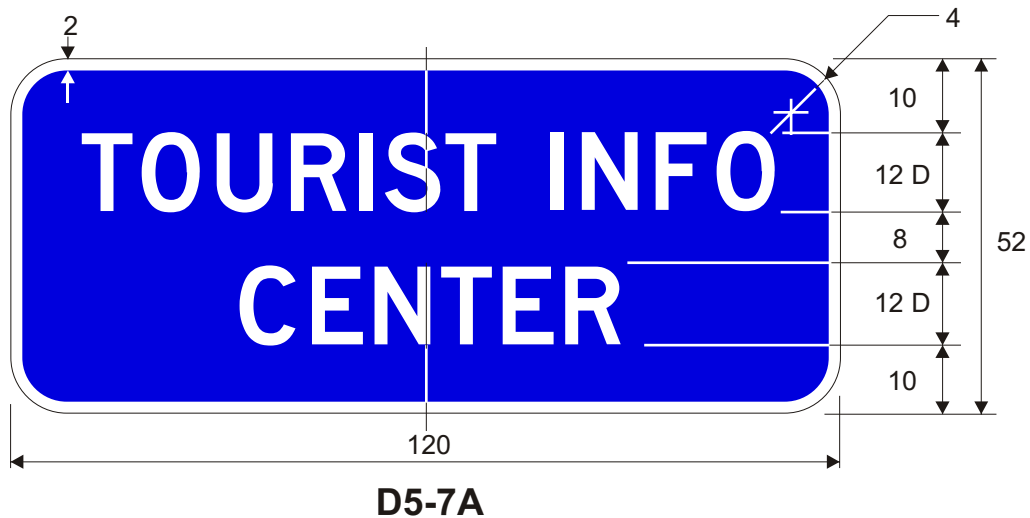

Border and Legend: White
Background: Blue

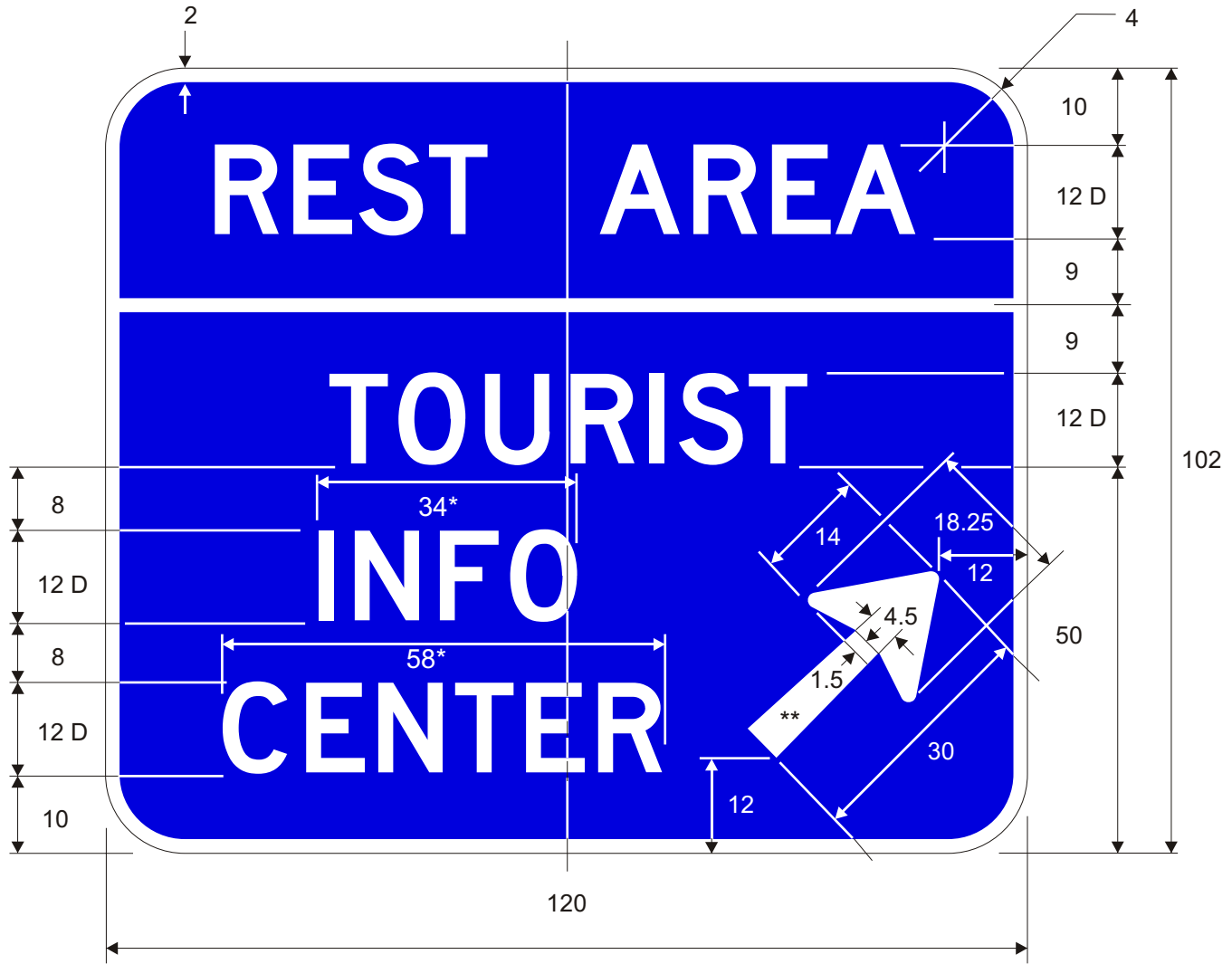

- * Optically center legend
- ** See Appendix B-2 for Arrow Details.

Border and Legend: White
Background: Blue

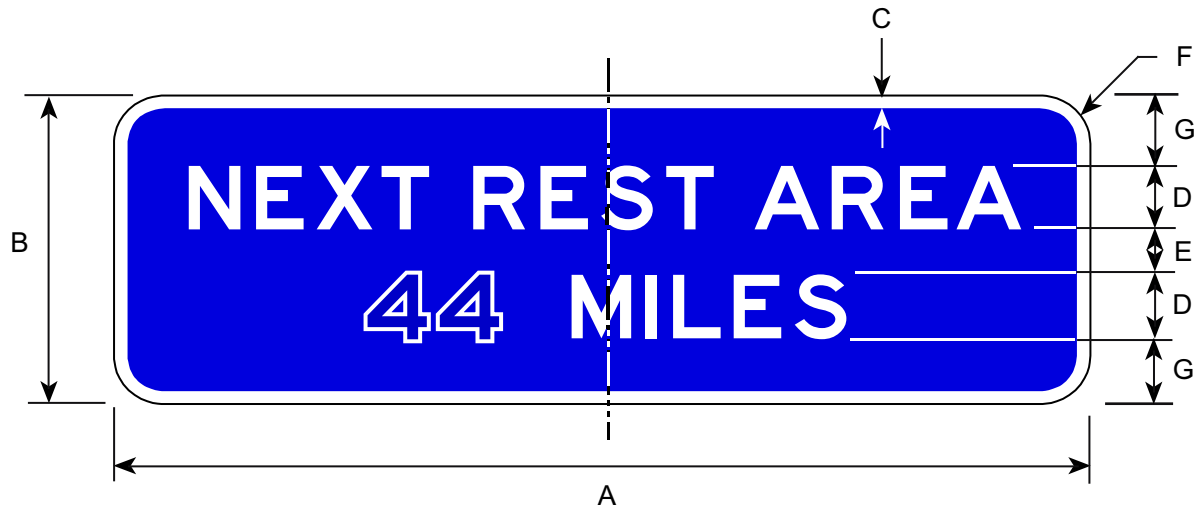

Border and Legend: White
Background: Blue

Road Class	Dimensions (inches)						
	A	B	C	D	E	F	G
Minimum	84	24	0.75	6E	3.5	1.50	4.25
Conventional	108	36	1.50	8E	5.5	2.25	7.25

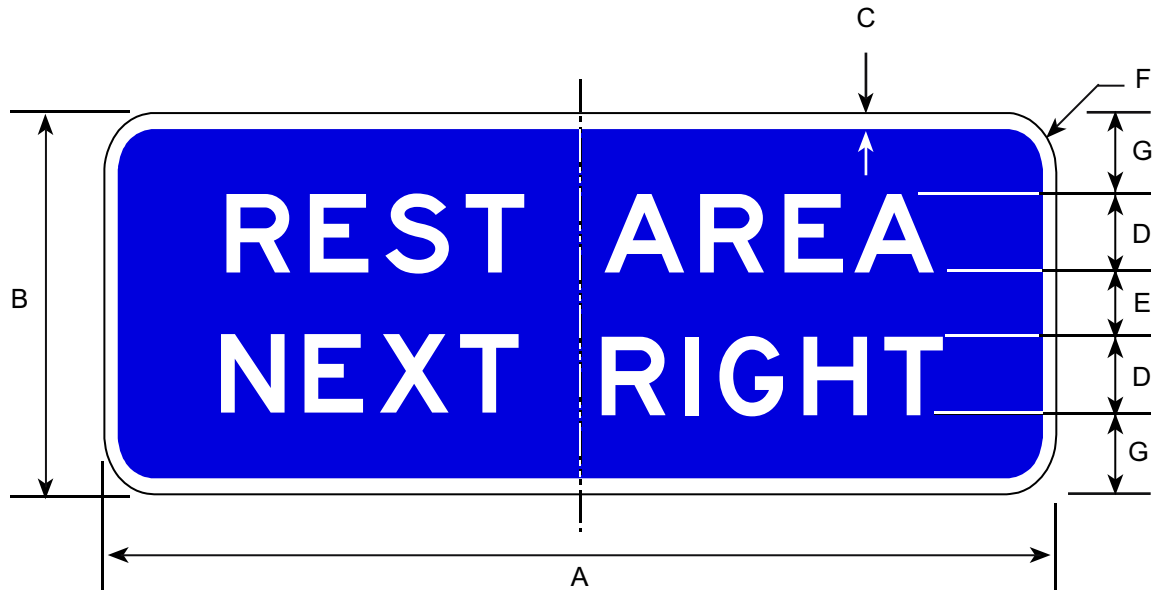

Border and Legend: White
 Background: Blue

Road Class	Dimensions (inches)						
	A	B	C	D	E	F	G
Conventional	96	36	1.5	8E	5.50	2.25	7.25
Expressway	120	48	2.0	10E	8.00	3.00	10.00
Freeway	144	60	2.0	12E	10.5	3.75	12.75

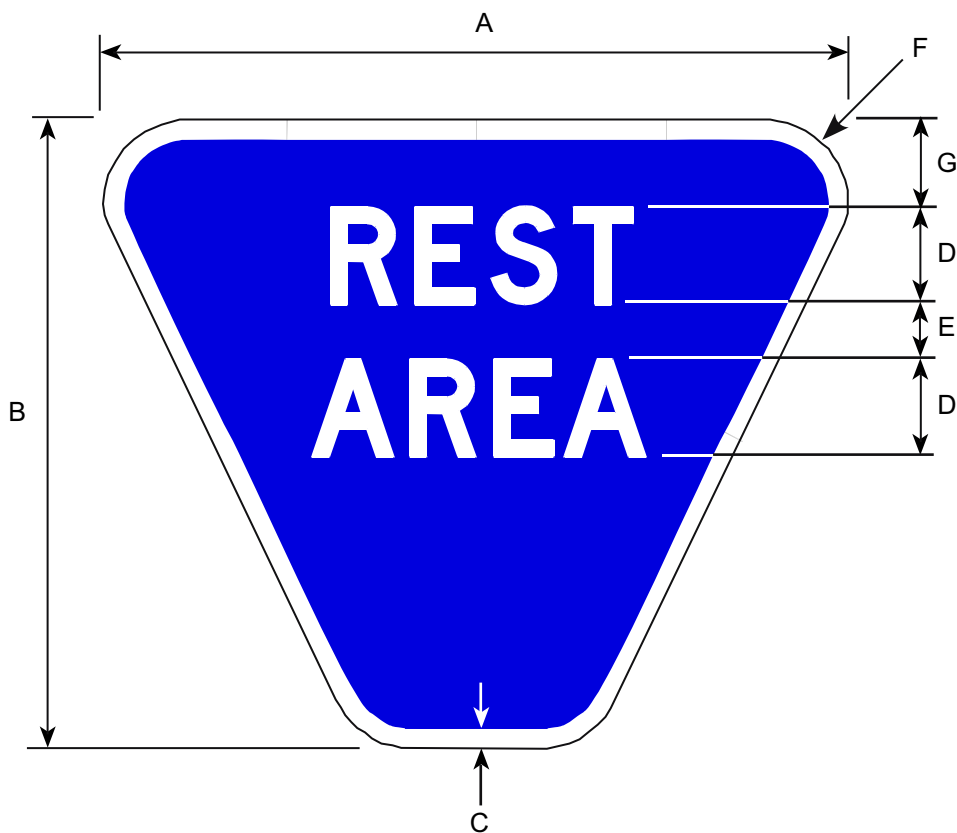

Border and Legend: White
 Background: Blue

Road Class	Dimensions (inches)						
	A	B	C	D	E	F	G
Minimum	36	30	0.63	4D	3	3	4
Conventional	48	40	1.00	6D	5	4	6

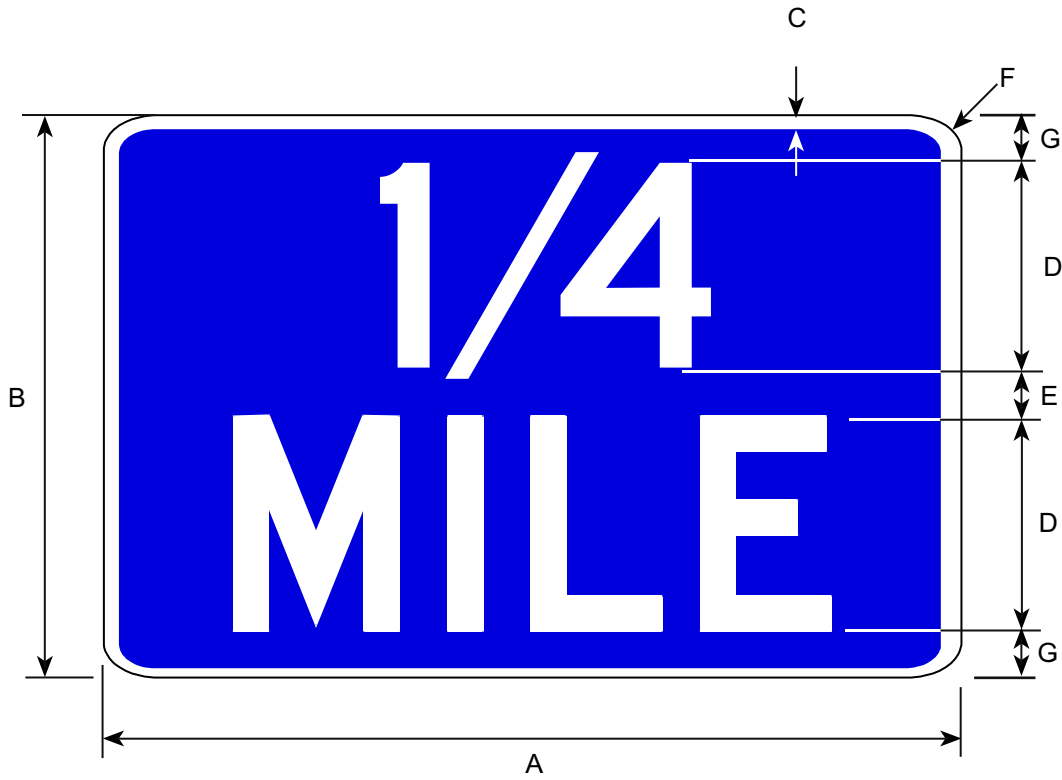

Border and Legend: White
 Background: Blue

Road Class	Dimensions (inches)						
	A	B	C	D	E	F	G
Minimum	18	12	0.38	4D	1.0	1.5	1.50
Conventional	24	18	0.50	6D	1.5	1.5	2.25

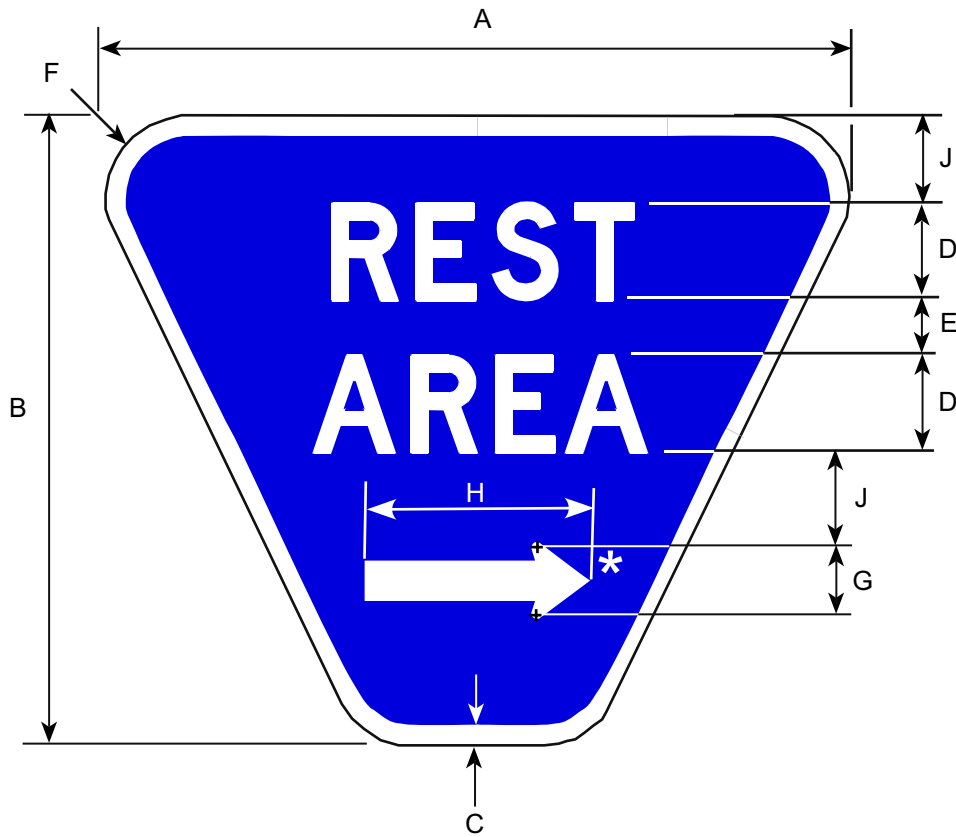

*See Appendix B-1 for standard arrow details.

Border and Legend: White
Background: Blue

Road Class	Dimensions (inches)								
	A	B	C	D	E	F	G	H	J
Minimum	36	30	0.63	4D	3.0	3.0	4.0	8.0	4.0
Conventional	48	40	1.0	6D	5.0	4.0	6.0	9.0	5.0

DESTINATION SIGNS - SCENIC AREA

D6-1 to D6-4A

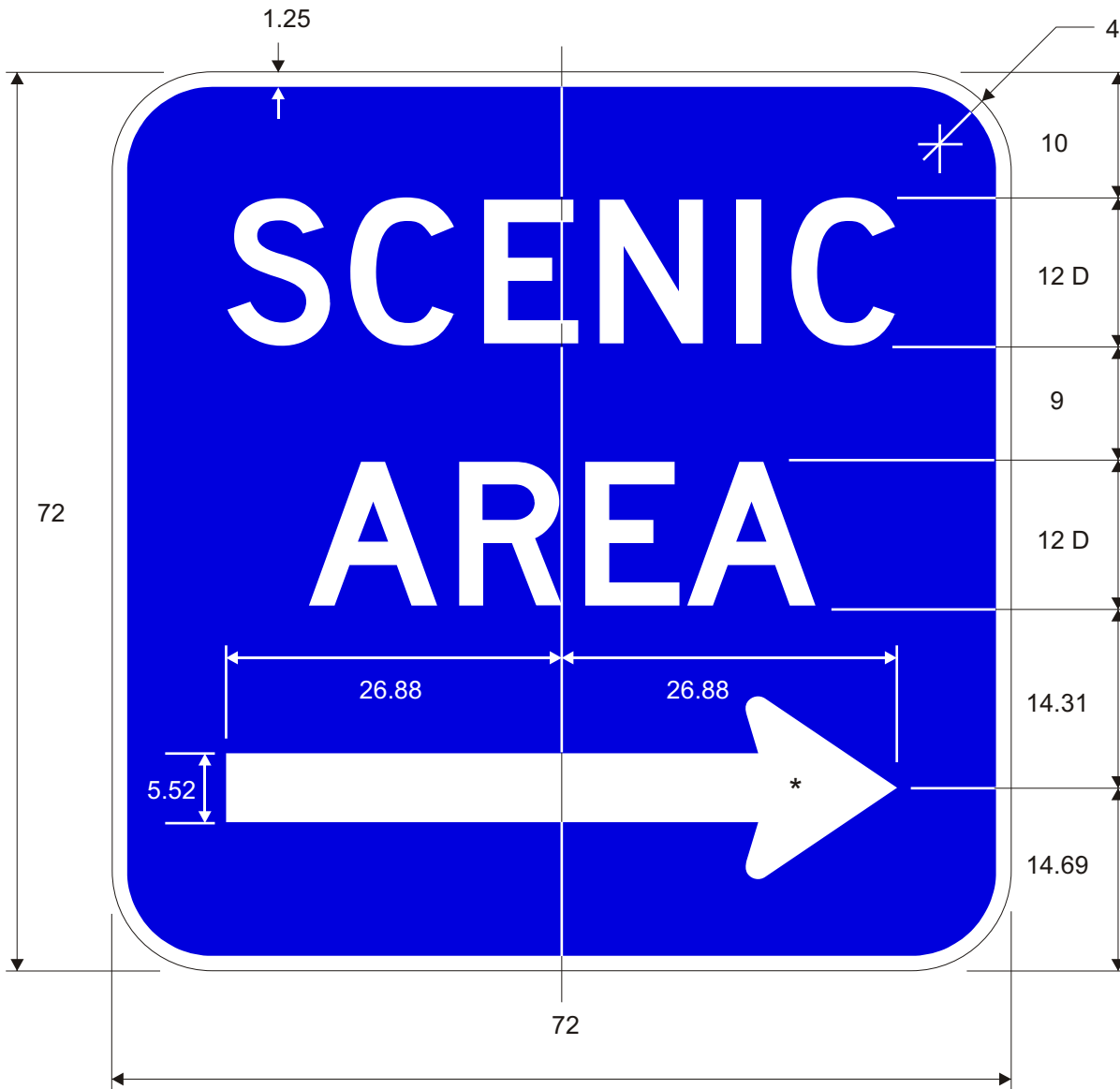

* See Appendix B-1 for Standard Arrow Details.
 For SCENIC OVERLOOK use 84" width.

Code	Variable Legend
A	AREA
B	VIEW
C	OVERLOOK
Example: D6-1B refers to "SCENIC VIEW"	

Border and Legend: White
 Background: Blue

D6-2_
D6-3_

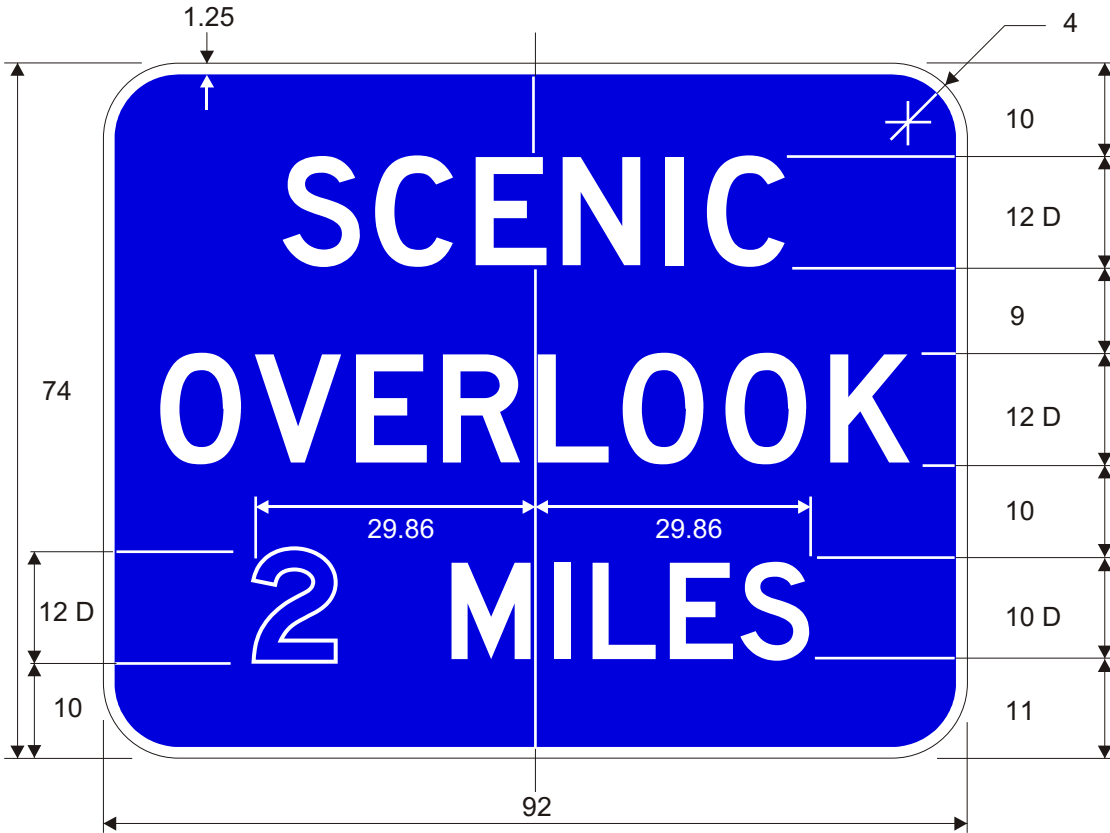

D6-2

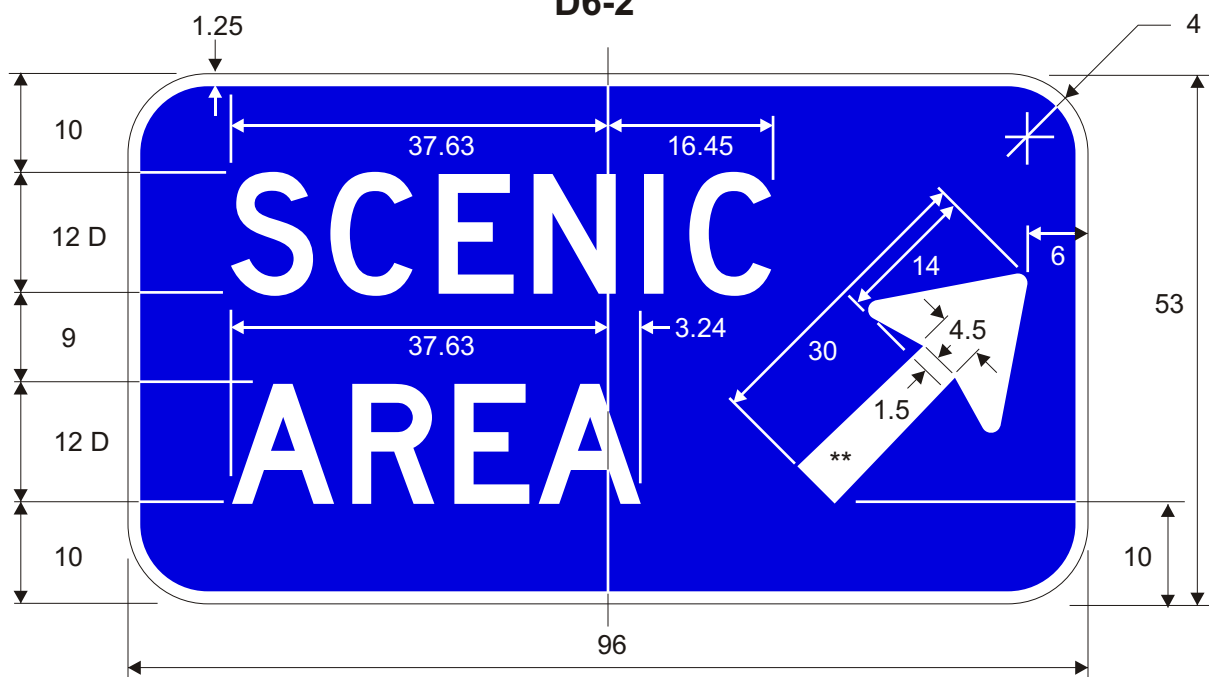

D6-3

Code	Variable Legend
A	AREA
B	VIEW
C	OVERLOOK

Example: D6-2B refers to "SCENIC VIEW 2 MILES"

* See Appendix B-1 for Standard Arrow Details.

Border and Legend: White
Background: Blue

D6-4 D6-4A

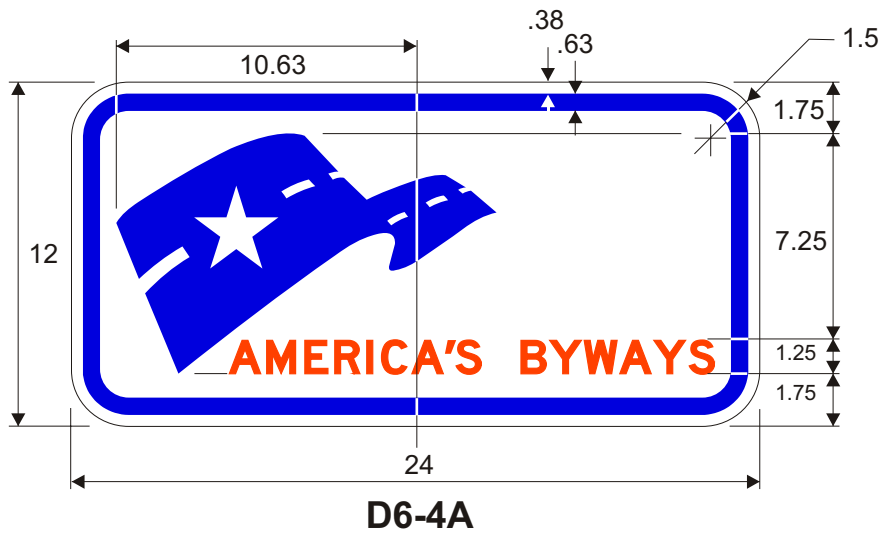
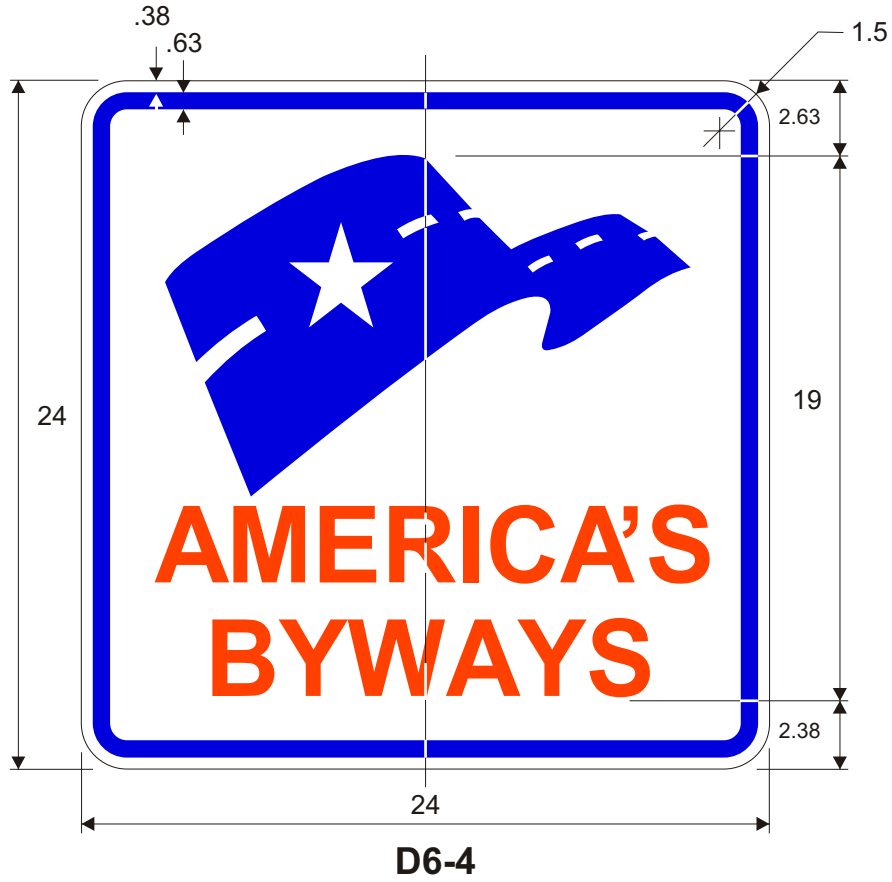

Border and Symbol: Blue
Background: White
Legend: Red

DESTINATION SIGNS - RECREATION

D7-1 to D7-RW

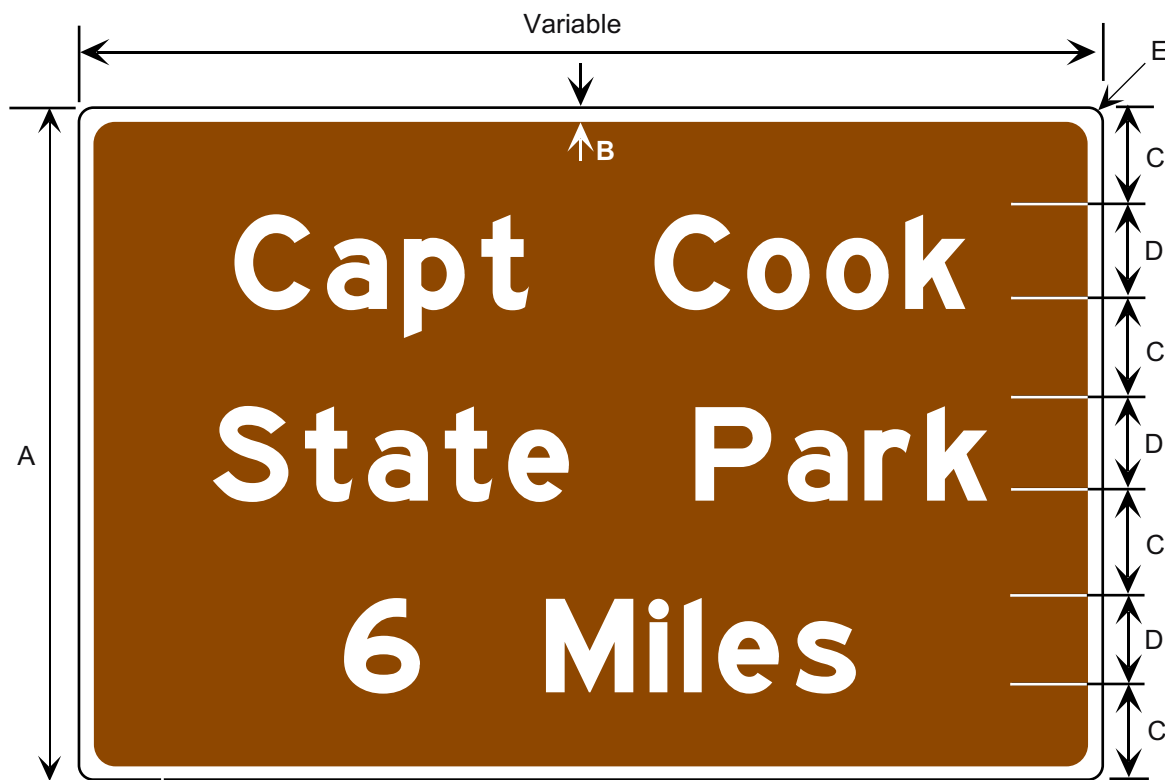

Border and Legend: White
 Background: Brown

Prior to the 2002 publication of this manual,
 this sign was numbered D7-3.

Road Class	Dimensions (inches)				
	A	B	C	D	E
Conv & Min	42	1.25	6	6/4	2.25

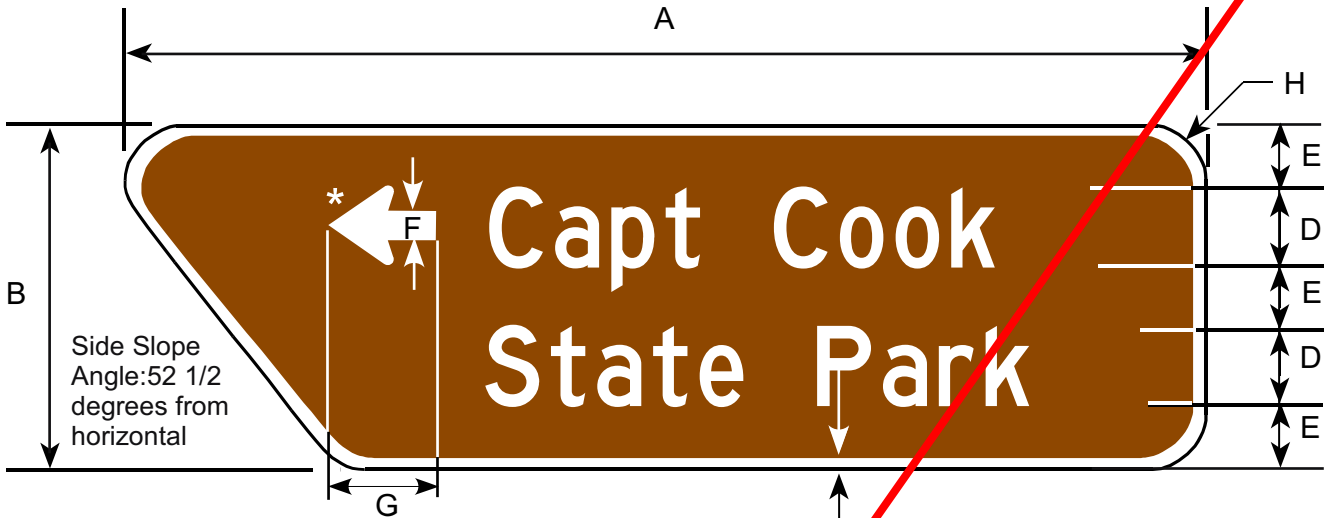

Angle the side of the sign the arrow is on.

Border and Legend: White
Background: Brown

* See Appendix B-1 for Standard Arrow

This drawing has been replaced with:
D7-2
Two Line Trapezoidal Destination &
Arrow
(11/09/09).

Click on the drawing number in the
upper right corner to go to the Interim
Addenda web page.

Prior to the 2002 publication of this manual,
this sign was numbered D7-2A.

Road Class	Dimensions (inches)							
	A	B	C	D	E	F	G	H
Minimum	VAR	30	0.75	6/4	6.0	2.25	9.0	3.0
Conventional	VAR	30	1.5	8/6	8.0	3.0	12	6.0

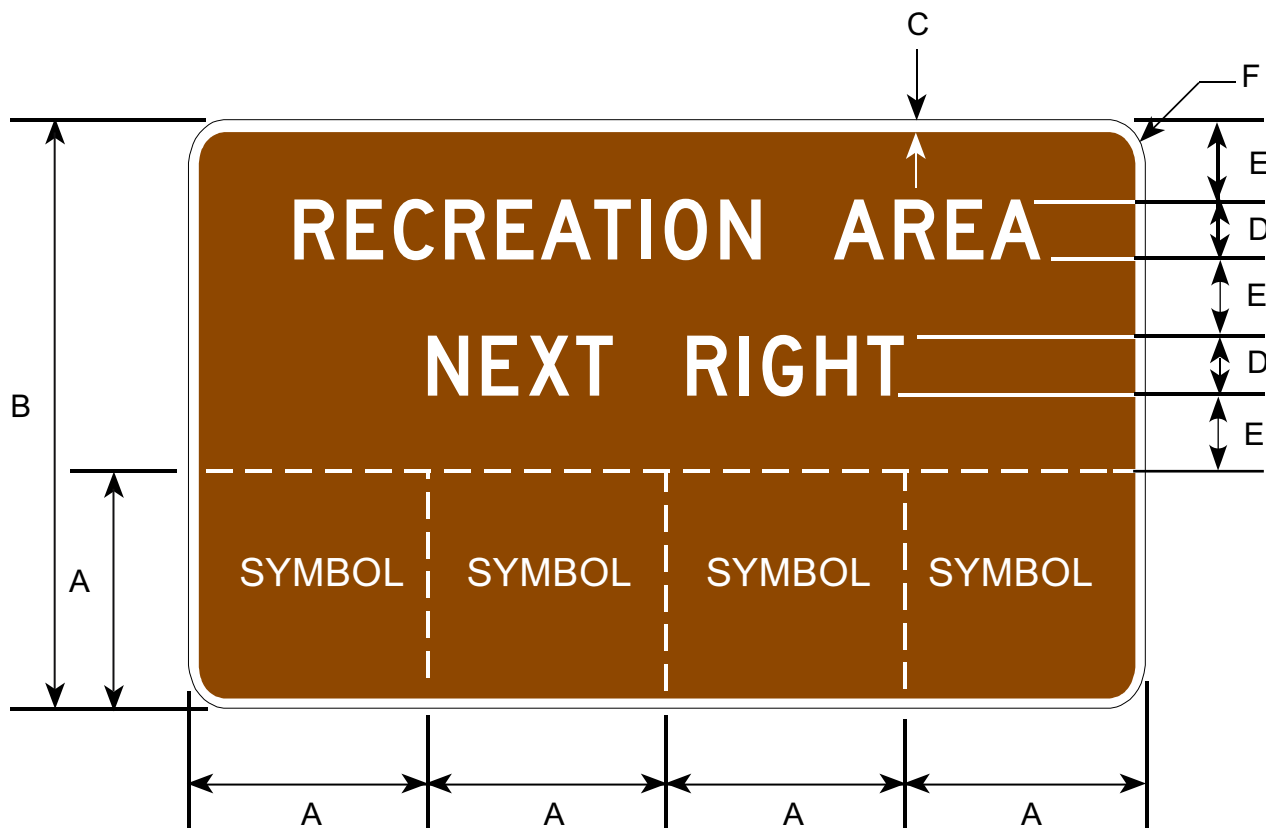

Border and Legend: White
Background: Brown

Road Class	Dimensions (inches)					
	A	B	C	D	E	F
Min & Conv	24	60	0.63	6D	8	1.5

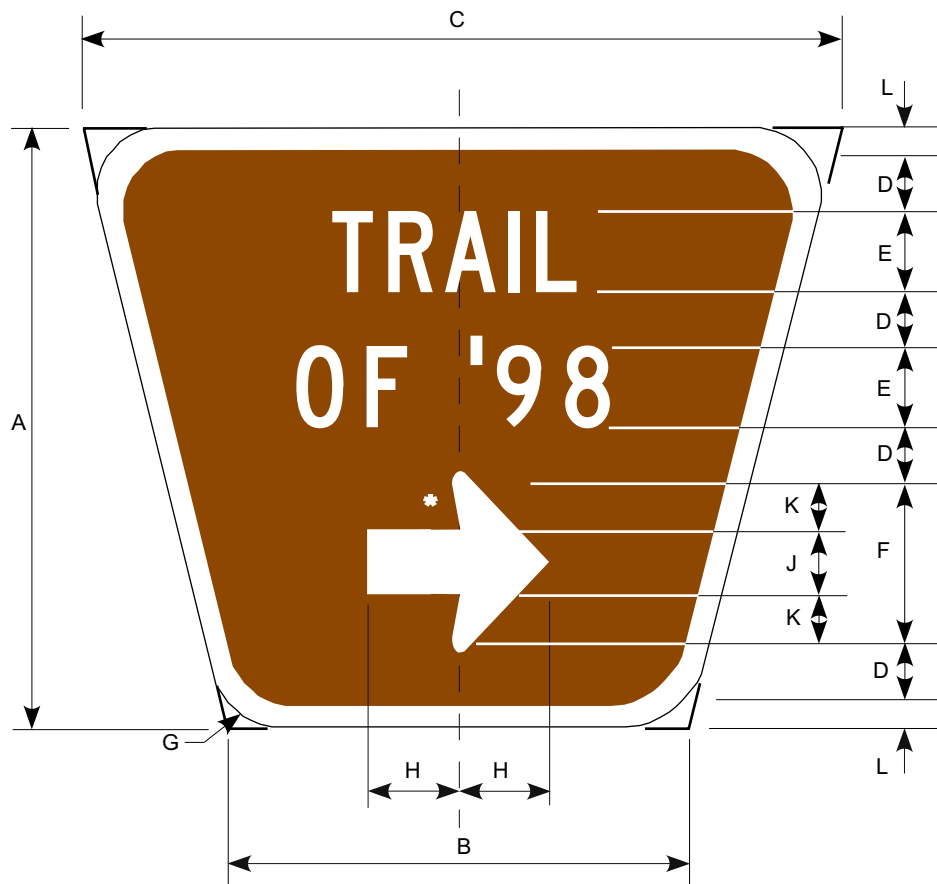

Any of the following legends may be used as alternates for line 3.

Code	Variable Legend
A	500 FT
B	1000 FT
C	1 MILE
D	1/2 MILE
E	1500 FT
F	AHEAD
G	NEXT RIGHT

Border and Legend: White
Background: Brown

Prior to the 2002 publication of this manual, this sign was numbered D7-4.

* See Appendix B-1 for standard arrow details.



Additional alternates for line 3.

Road Class	Dimensions (inches)											
	A	B	C	D	E	F	G	H	J	K	L	N
Conventional	36	29	48	3.5	5C	10	3.0	4.06	4	3	1	4C
Expwy/Fwy	42	38	60	4.0	6C	12	3.5	6.38	6	3	1	5C

D7-RA Accommodation Plates (1 of 2)



Campfire
RA-030



Laundry
D7-RA-060



Information
D7-RA-080



Sleeping Shelter
D7-RA-110 *

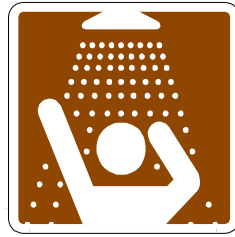

Showers
D7-RA-130

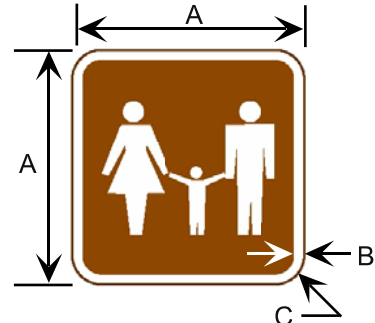

Family Rest Room
D7-RA-150



Helicopter
D7-RA-160

* For Non-Road Use

Border and Legend: White
Background: Brown

Make symbol proportional to
graphic shown.

Road Class	Dimensions (inches)		
	A	B	C
Minimum	18	0.38	1.50
Conventional	24	0.63	1.50
Expwy / Fwy	30	0.75	1.88

D7-RA Accommodation Plates (2 of 2)



Bus Stop
D7-RA-020

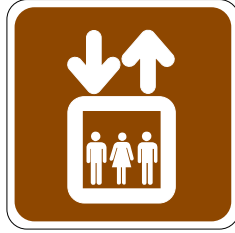

Elevator
D7-RA-040



Kennel
D7-RA-050



Locker
D7-RA-70



Parking
D7-RA-80

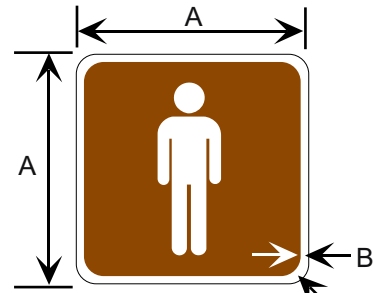

RA-150
Rest Room (men)
D7-RA-90



Rest Room (women)
D7-RA-100

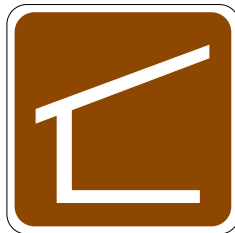

Shelter (trail)
D7-RA-120

Border and Legend: White
Background: Brown

Make symbol proportional to
graphic shown.

Road Class	Dimensions (inches)		
	A	B	C
Minimum	18	0.38	1.50
Conventional	24	0.63	1.50
Expwy / Fwy	30	0.75	1.88

D7-RG General Information Plates (1 of 2)

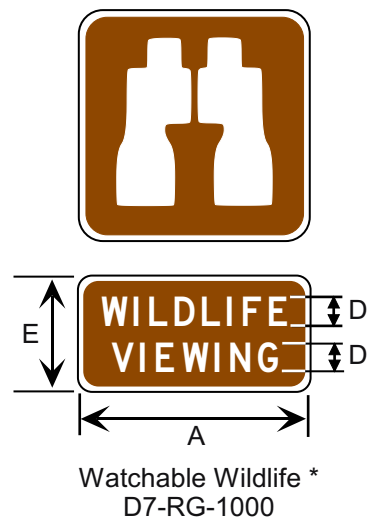
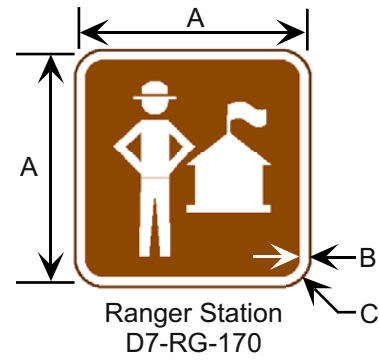
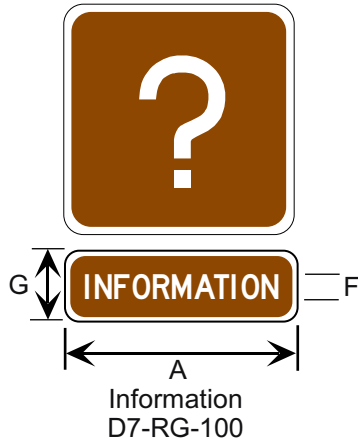

Border and Legend: White
Background: Brown

Make symbol proportional to graphics shown.

* The Watchable Wildlife plates may only be used for officially-approved sites published in the "Alaska Wildlife Viewing Guide," or similar guides developed by ADF&G.

Road Class	Dimensions (inches)						
	A	B	C	D	E	F	G
Minimum	18	0.38	1.50	2E	9	2C	6
Conventional	24	0.63	1.50	3D	12	2E	6
Expwy / Fwy	30	0.75	1.88	4D	15	3D	9

D7-RG General Information Plates (2 of 2)

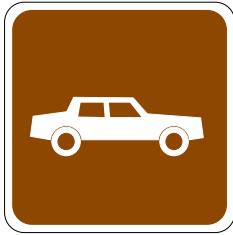

Automobile
D7-RG-010



Bear Viewing Area
D7-RG-020

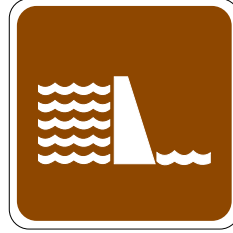

Dam
D7-RG-030

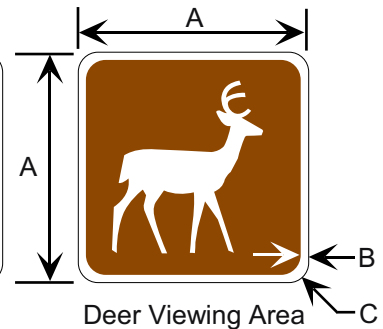

Deer Viewing Area
D7-RG-040



Drinking Water
D7-RG-060



Environmental Study
D7-RG-060



Falling Rock
D7-RG-070

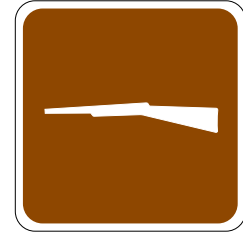

Firearms
D7-RG-080

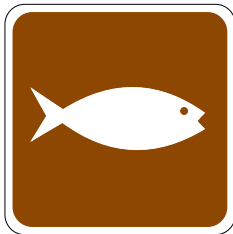

Fish Hatchery
D7-RG-090



Leashed Pets
D7-RG-110



Lighthouse
D7-RG-120



Lookout Tower
D7-RG-140



Pedestrian Crossing
D7-RG-150

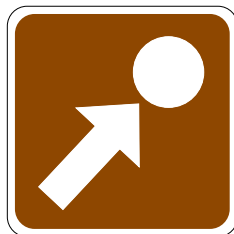

Point of Interest
D7-RG-160



Smoking
D7-RG-180



Truck
D7-RG-190



Tunnel
D7-RG-200

Border and Legend: White
Background: Brown
Make symbol proportional to
graphics shown.

Road Class	Dimensions (inches)		
	A	B	C
Minimum	18	0.38	1.50
Conventional	24	0.63	1.50
Expwy / Fwy	30	0.75	1.88

D7-RL Land Recreation Plates (1 of 2)



Amphitheater
RL-010



Rock Climbing
RL-030

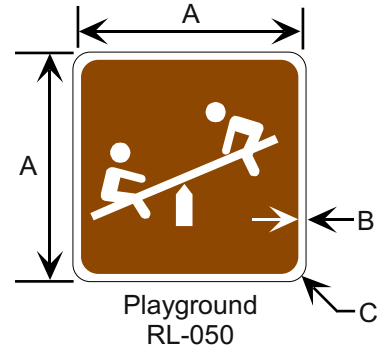

Playground
RL-050



Hiking
RL-100



Horse Riding
RL-110



Interpretive Trail
RL-130



4 WD Trail
RL-140



Motorcycle Trail
RL-150



ATV Trail
RL-170



Archery
RL-190



Hang Gliding
RL-210



Golf
RL-500

Road Class	Dimensions (inches)		
	A	B	C
Minimum	18	0.38	1.50
Conventional	24	0.63	1.50
Expwy / Fwy	30	0.75	1.88

Border and Legend: White
Background: Brown

Make symbol proportional to graphic shown.

D7-RL Land Recreation Plates (2 of 2)



Hunting
RL-040



Rock Collecting
RL-060

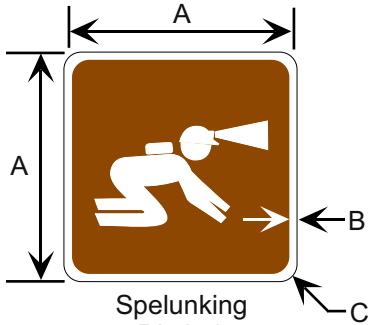

Spelunking
RL-070



Stable
RL-080



Trail (bicycle)
RL-090

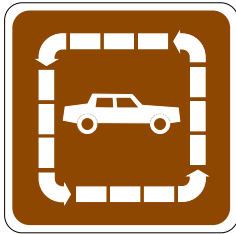

Trail (auto)
RL-120

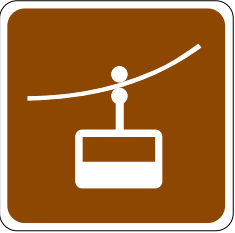

Tramway
RL-160

Border and Legend: White
Background: Brown

Make symbol proportional to
graphic shown.

Road Class	Dimensions (inches)		
	A	B	C
Minimum	18	0.38	1.50
Conventional	24	0.63	1.50
Expwy / Fwy	30	0.75	1.88

D7-RM Motorist Service Plates (1 of 2)



Tent Camping
D7-RM-010



Trailer Camping
D7-RM-020

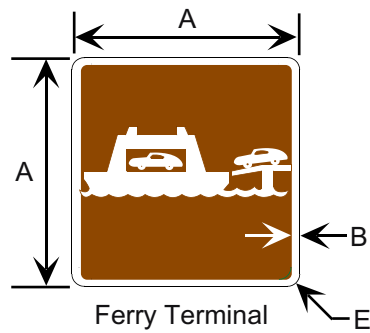

Ferry Terminal
D7-RM-030



Food
D7-RM-050



Gas
D7-RM-060

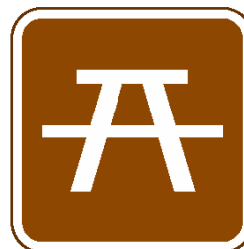

Picnic Area
D7-RM-120

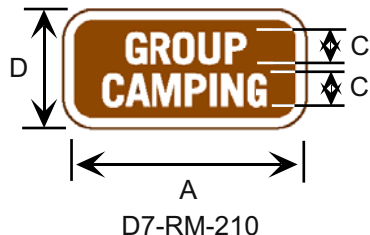

D7-RM-210



Telephone
D7-RM-150



Motor Home
D7-RM-200

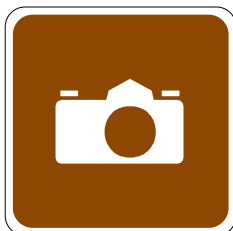

Viewing Area
D7-RM-170



D7-RM-220

Road Class	Dimensions (inches)				
	A	B	C	D	E
Minimum	18	0.38	2C	9	1.50
Conventional	24	0.63	3C	12	1.50
Expwy / Fwy	30	0.75	4C	15	1.88

Border and Legend: White
Background: Brown

Make symbol proportional to graphic shown.

D7-RM Motorist Service Plates (2 of 2)



First Aid
D7-RM-040

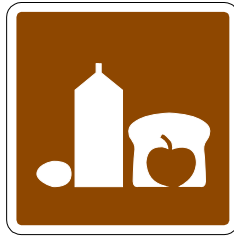

Grocery Store
D7-RM-070

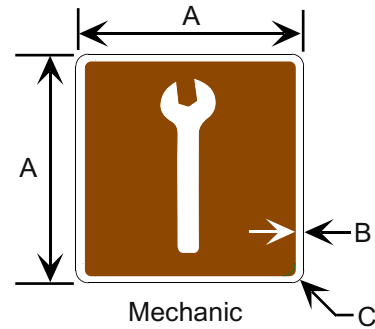

Mechanic
D7-RM-100



Post Office
D7-RM-110

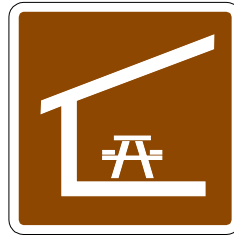

Picnic Shelter
D7-RM-130



Rest Room
D7-RM-140

Border and Legend: White
Background: Brown

Make symbol proportional to
graphic shown.

Road Class	Dimensions (inches)		
	A	B	C
Minimum	18	0.38	1.50
Conventional	24	0.63	1.50
Expwy / Fwy	30	0.75	1.88

D7-RS Winter Recreation Plates (1 of 2)



Skating
D7-RS-010



Ski Jumping
D7-RS-020



Cross-Country Skiing
D7-RS-040



Downhill Skiing
D7-RS-050



Sledding
D7-RS-060

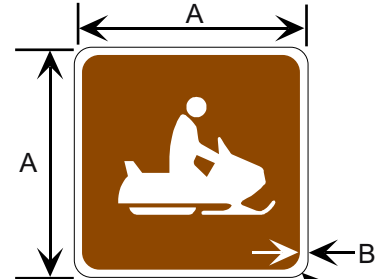

Snow Mobiling
D7-RS-070



Winter Rec Area
D7-RS-090



Chair Lift
D7-RS-100

Border and Legend: White
Background: Brown

Make symbols proportional
to the graphics shown.

Road Class	Dimensions (inches)		
	A	B	C
Minimum	18	0.38	1.50
Conventional	24	0.63	1.50
Expwy / Fwy	30	0.75	1.88

D7-RS Winter Recreation Plates (2 of 2)



Skiing (bobbing)
D7-RS-030

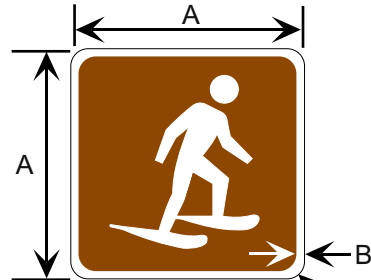

Snowshoeing
D7-RS-080

Border and Legend: White
Background: Brown

Make symbols proportional
to the graphics shown.

Road Class	Dimensions (inches)		
	A	B	C
Minimum	18	0.38	1.50
Conventional	24	0.63	1.50
Expwy / Fwy	30	0.75	1.88

D7-RW Water Recreation Plates (1 of 2)



Canoeing
D7-RW-020

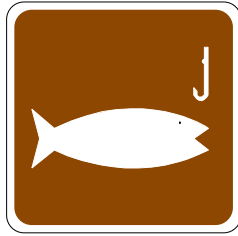

Fishing
D7-RW-050

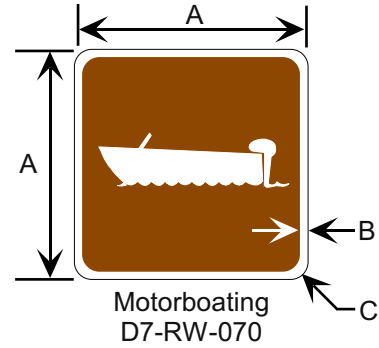

Motorboating
D7-RW-070



Launch Ramp
D7-RW-080



Sailboating
D7-RW-100



Water Skiing
D7-RW-110



Swimming
D7-RW-130



Fishing Pier
D7-RW-160



Hand Launch
D7-RW-170



Kayaking
D7-RW-190



Wind Surfing
D7-RW-210

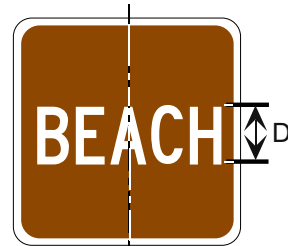

D7-RW-500

Road Class	Dimensions (inches)			
	A	B	C	D
Minimum	18	0.38	1.50	4C
Conventional	24	0.63	1.50	6C
Expwy / Fwy	30	0.75	1.88	8C

Border and Legend: White
Background: Brown

Make symbol proportional to graphic shown.

D7-RW Water Recreation Plates (2 of 2)

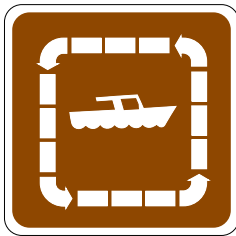

Boat Tours
D7-RW-010



Diving
D7-RW-010

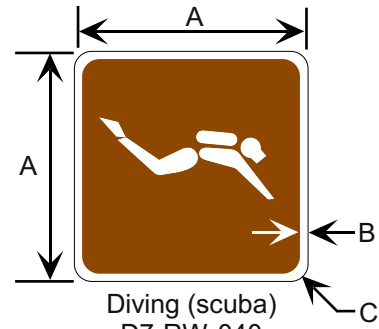

Diving (scuba)
D7-RW-040



Marina
D7-RW-060



Rowboating
D7-RW-090



Surfing
D7-RW-120



Wading
D7-RW-140

Border and Legend: White
Background: Brown

Make symbol proportional to
graphic shown.

Road Class	Dimensions (inches)		
	A	B	C
Minimum	18	0.38	1.50
Conventional	24	0.63	1.50
Expwy / Fwy	30	0.75	1.88

DESTINATION SIGNS - WEIGHT STATION/ CUSTOMS

D8-1 to D8-104



Border and Legend: White
Background: Green

Road Class	Dimensions (inches)							
	A	B	C	D	E	F	G	H
Conventional	60	48	1.5	6.0	8E	6E	6.0	3.0
Expressway	78	60	2.0	8.0	10E	8E	7.0	4.0
Freeway	96	72	2.0	9.0	12E	10E	9.0	5.0

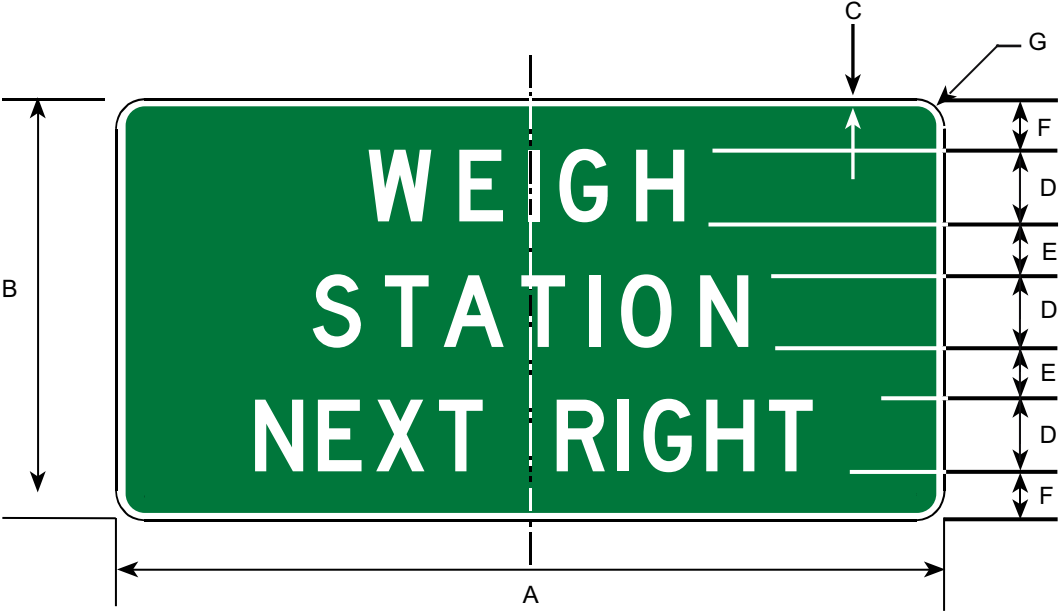

Border and Legend: White
 Background: Green

Road Class	Dimensions (inches)						
	A	B	C	D	E	F	G
Conventional	72	36	1.5	6D	4.0	5.0	4.0
Expywy/Fwy	108	60	2.0	10D	7.0	8.0	6.0

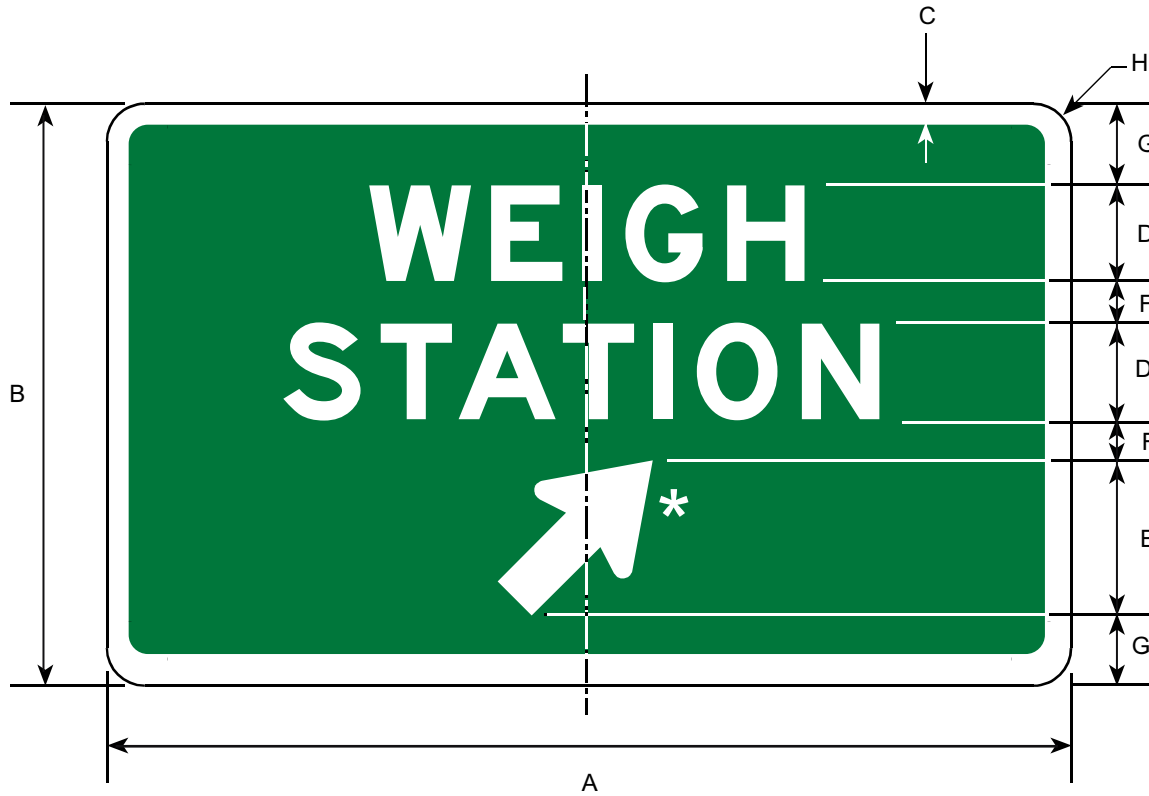

Border and Legend: White
Background: Green

*See Appendix B-4 for Arrow Details.

Road Class	Dimensions (inches)							
	A	B	C	D	E	F	G	H
Conventional	60	36	1.5	6E	10.88	2.5	4.06	4.0
Expwy/Fwy	84	60	2.0	10E	14.75	5.0	7.63	6.0

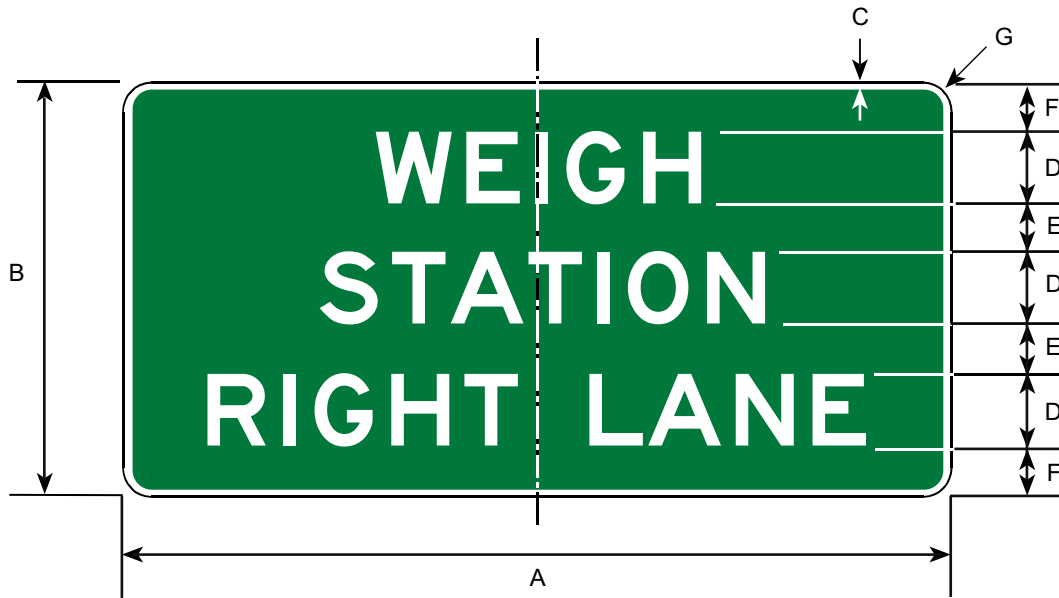

Border and Legend: White
Background: Green

Prior to the 2002 publication of this manual,
this sign was numbered D8-2.

Road Class	Dimensions (inches)						
	A	B	C	D	E	F	G
Conventional	72	36	1.5	6D	4.0	5.0	2.3
Expwy/Fwy	108	60	2.0	10D	7.0	8.0	3.8

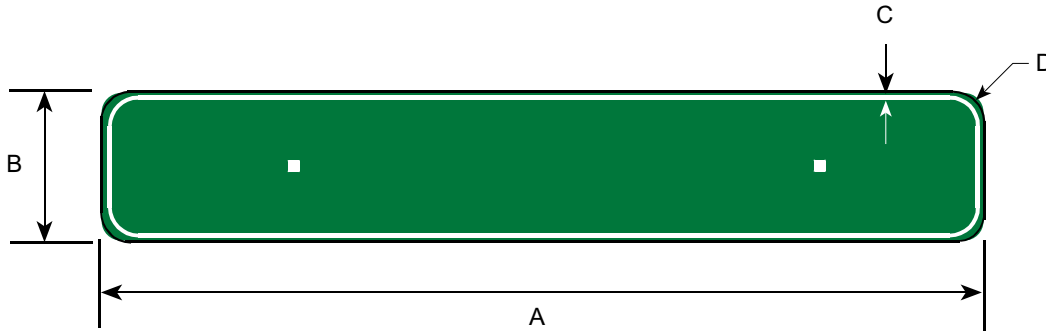

Road Class	Dimensions (inches)			
	A	B	C	D
Conventional	72	12	1.5	0.75
Expwy/Fwy	108	24	2.0	1.5

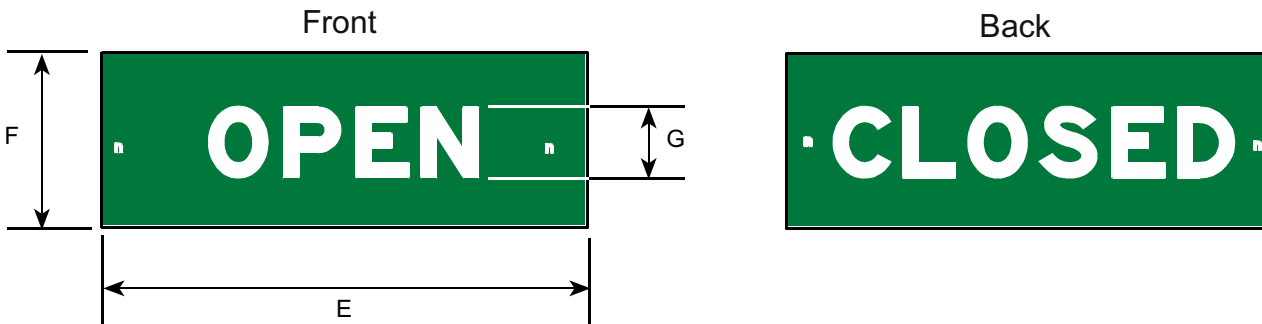

Road Class	Dimensions (inches)		
	E	F	G
Conventional	42	8	6E
Expwy/Fwy	66	12	10E

Border and Legend: White
Background: Green

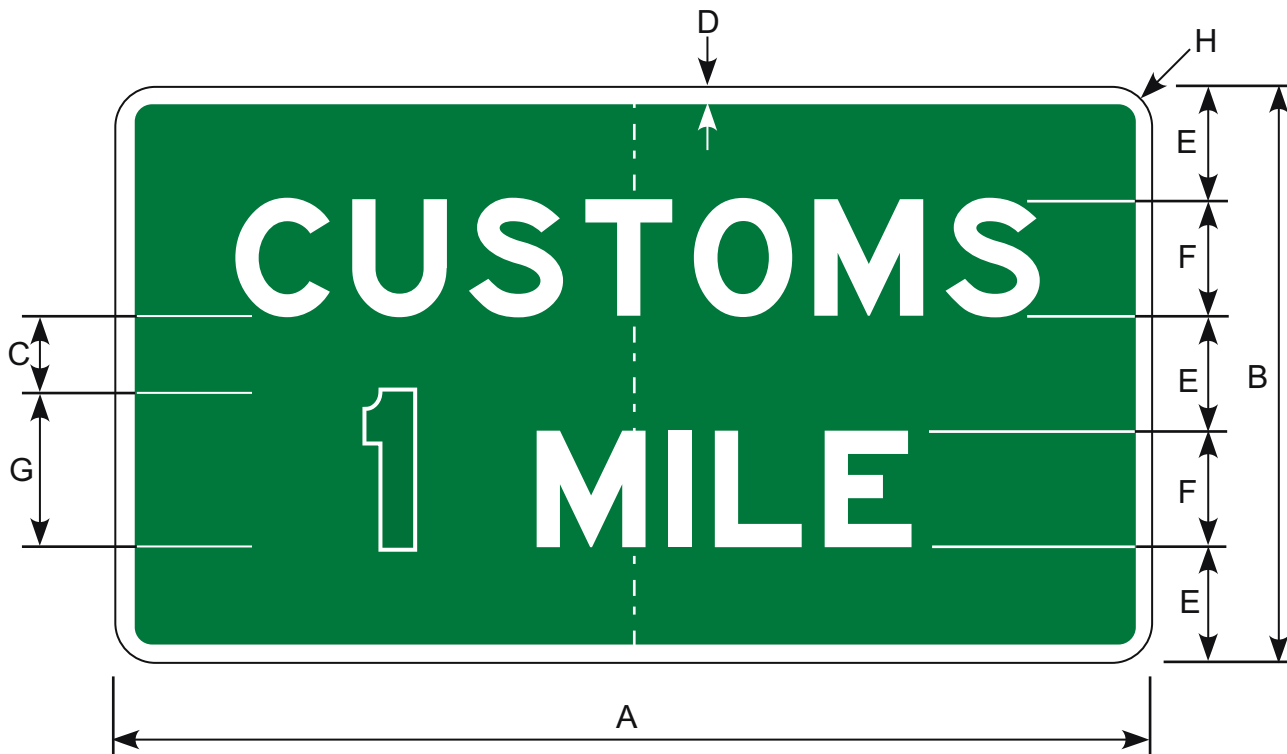

Border and Legend: White
Background: Green

Prior to the 2002 publication of this manual,
this sign was numbered D8-6C.

Road Class	Dimensions (inches)							
	A	B	C	D	E	F	G	H
Conv/Min	54	30	4	1	6	6E	8E	2.25
Expwy/Fwy	108	60	8	2	12	12E	16E	5.00

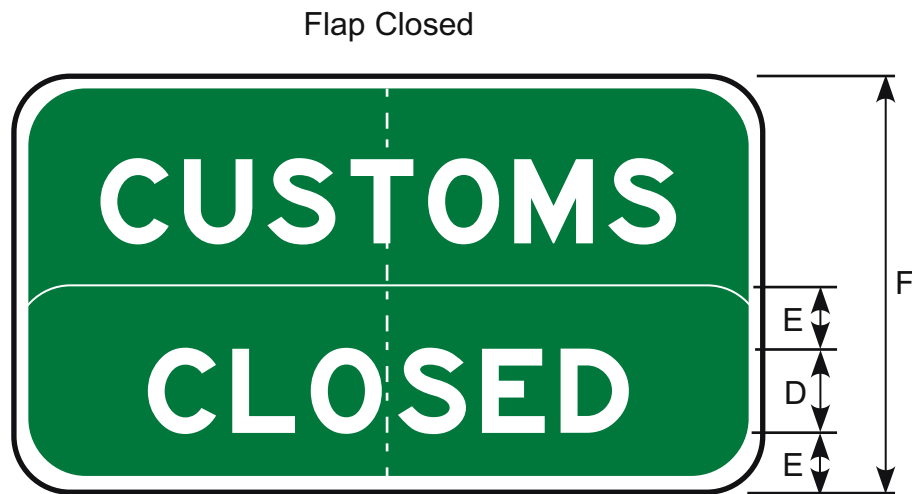
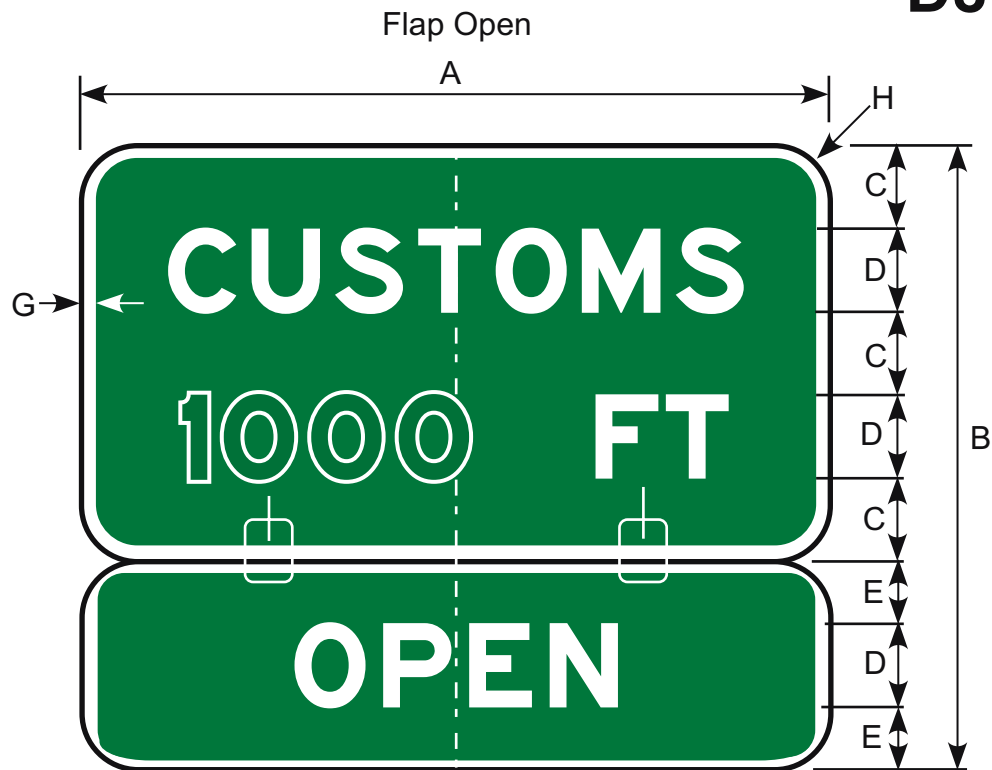

Border and Legend: White
Background: Green

Prior to the 2002 publication of this manual, this sign was numbered D8-8.

Road Class	Dimensions (inches)							
	A	B	C	D	E	F	G	H
Conv/Min	54	46	6.0	6E	5.0	30	0.75	4.0
Expwy/Fwy	72	60	8.0	8E	6.0	40	2.0	4.0

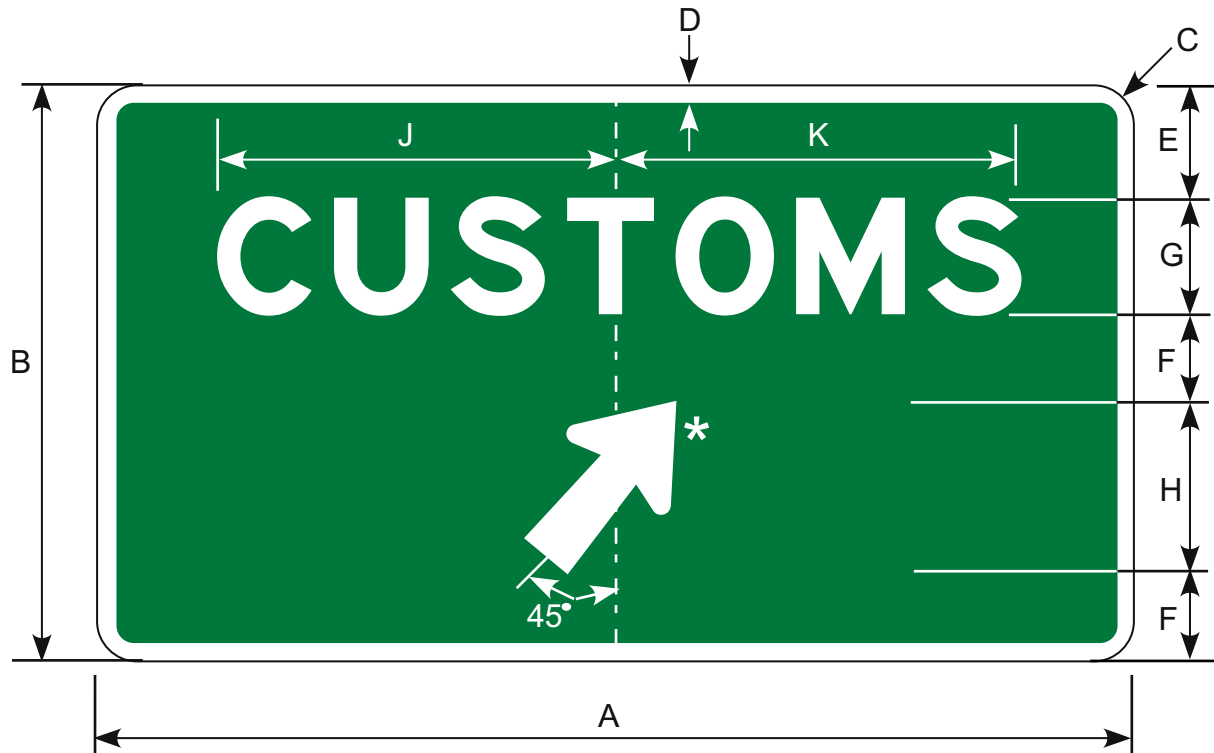

Border and Legend: White
Background: Green

*See Appendix B-4 for Arrow Details.

Prior to the 2002 publication of this manual,
this sign was numbered D8-7.

Road Class	Dimensions (inches)									
	A	B	C	D	E	F	G	H	J	K
Conv/Min	54	30	2.25	1.0	6.0	3.5	6E	11	20.75	20.81
Expwy/Fwy	108	60	3.75	2.0	12	10.0	12E	15	41.50	41.63

DESTINATION SIGNS - GENERAL SERVICES

D9-1 to D9-308

General Service Plates (1 of 3)

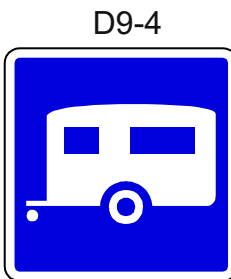
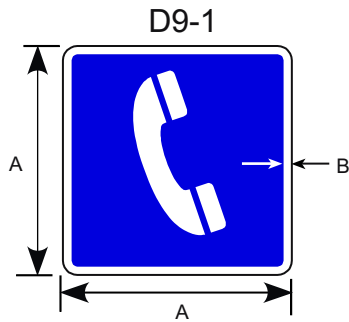

Border and Legend: White
 Background: Blue
 Slashes: Red

Make symbols proportional
 to the graphics shown.

More detail for some of these plates
 is shown on following pages.

Road Class	Dimensions (inches)	
	A	B
For Use on D9-204, D9-206	18	0.50
Conv/Min	24	0.50
Expressway	30	0.75

General Service Plates (2 of 3)

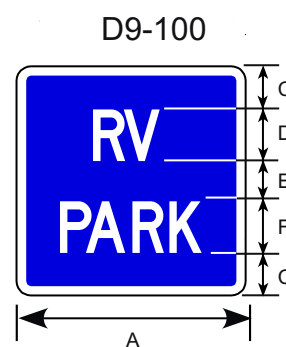
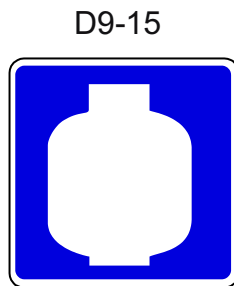
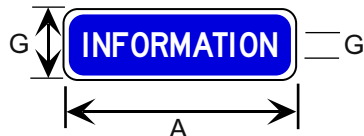
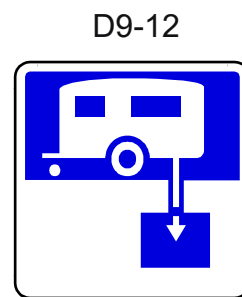
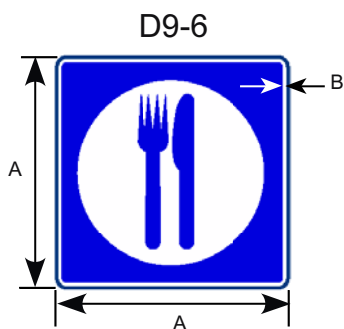

Border and Legend: White
Background: Blue

Make symbol proportional to graphic shown.

More detail for some of these signs is shown on the following pages.

Road Class	Dimensions (inches)							
	A	B	C	D	E	F	G	H
For Use on D9-204, D9-206	18	0.50	3.0	4E	4	4D	6	2C
Conv/Min	24	0.50	4.5	5E	5	5D	6	2E
Expressway	30	0.75	4.5	7E	7	7D	9	3D

General Service Plates (3 of 3)

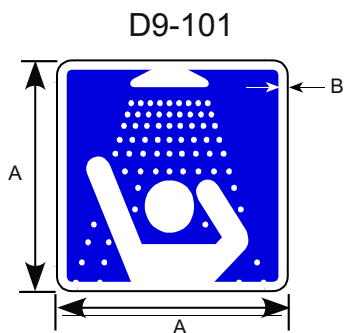

TROOPERS



PARKING



WATER

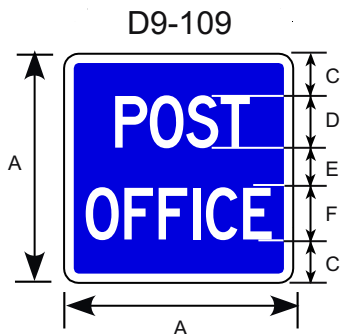

Make symbol proportional to graphic shown.

Educational plaques are optional.

More detail for some of these signs is shown on the following pages.

Border and Legend: White
Background : Blue

Road Class	Dimensions (inches)					
	A	B	C	D	E	F
For Use on D9-204, D9-206	18	0.50	3.0	4E	4	4C
Conv/Min	24	0.50	4.5	5E	5	5C
Expressway	30	0.75	4.5	7E	7	6C

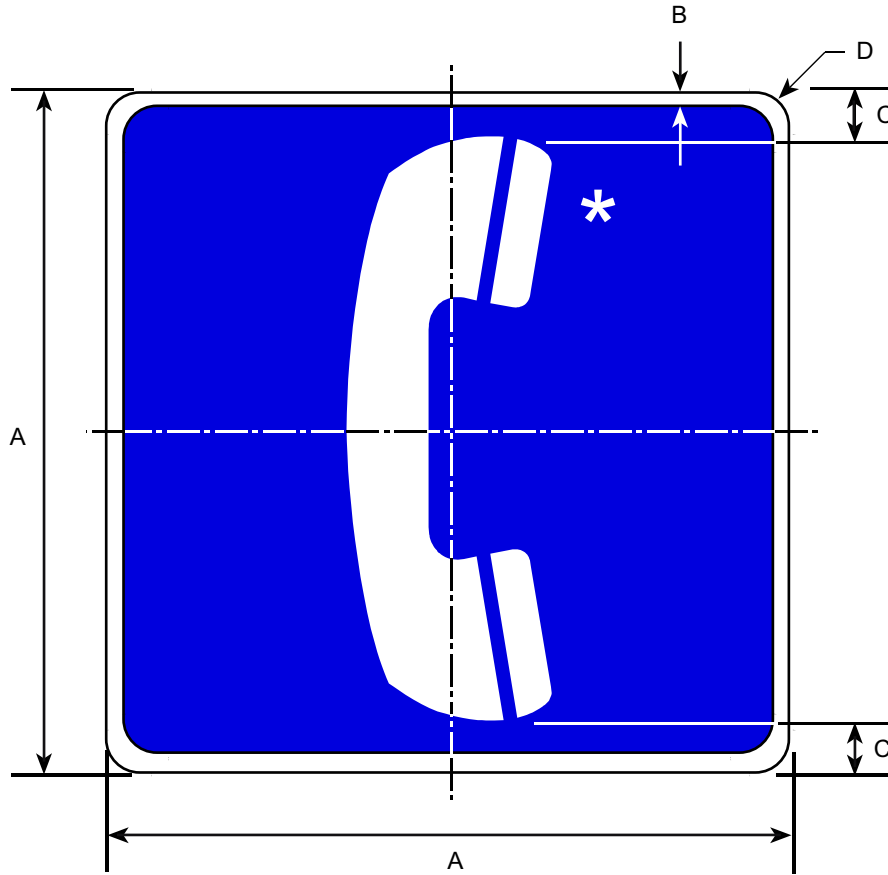

Border and Legend: White
Background: Blue

* Make symbol proportional to the graphic shown.

Road Class	Dimensions (inches)			
	A	B	C	D
Minimum	18	0.50	1.0	1.50
Conventional	24	0.50	1.5	1.50
Oversized	30	0.75	2.0	1.88

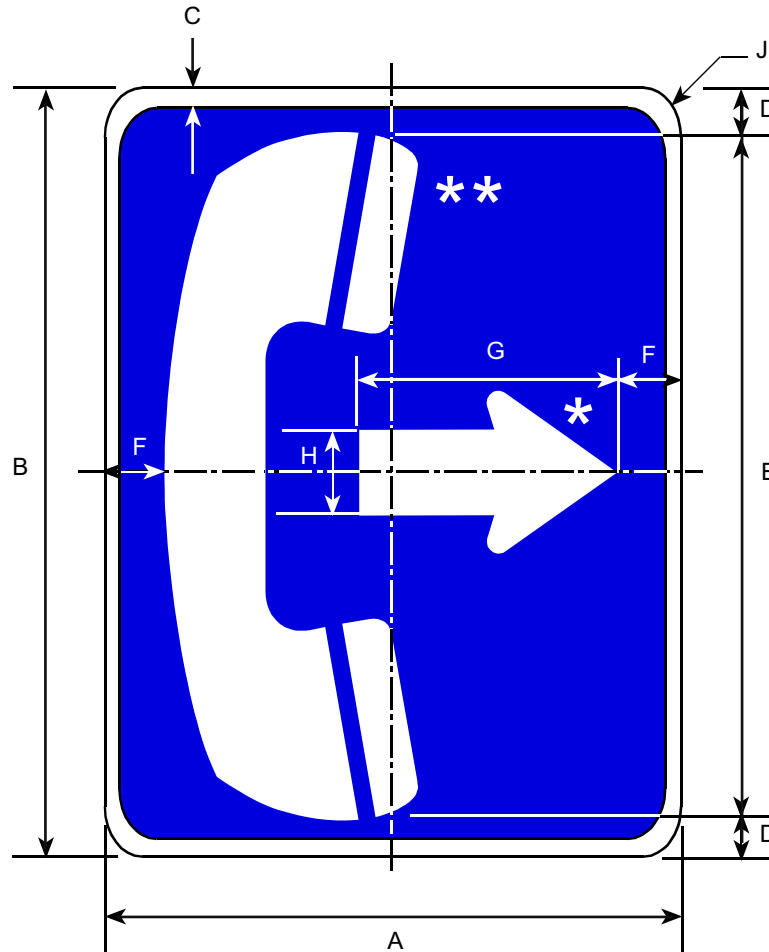

Border and Legend: White
Background: Blue

* See Appendix B-1 for standard arrow details.

** Make symbol proportional to graphic shown.

Prior to the 2002 publication of this manual,
this sign was numbered D9-1.

Road Class	Dimensions (inches)								
	A	B	C	D	E	F	G	H	J
Minimum	18	24	0.50	1.5	21	1.25	8.5	2.0	1.5
Conventional	24	30	0.63	2.0	26	2.5	10.5	2.63	1.5
Oversized	30	36	0.75	2.5	31	3.0	13.25	3.25	1.88

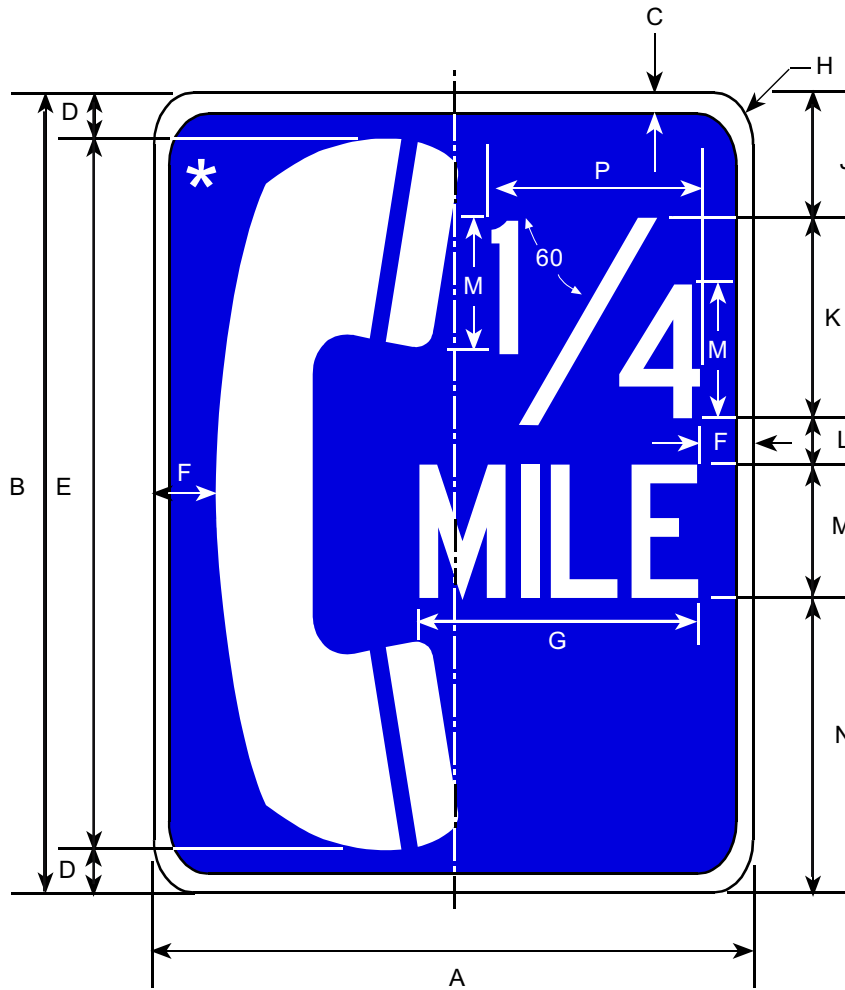

Border and Legend: White
Background: Blue

* Make symbol proportional to graphic shown.

Prior to the 2002 publication of this manual, this sign was numbered D9-1A.

Road Class	Dimensions (inches)													
	A	B	C	D	E	F	G	H	J	K	L	M	N	P
Minimum	18	24	0.50	1.5	21	1.0	9.50	1.50	3.75	6.0	1.5	4C	8.75	8
Conventional	24	30	0.63	2.0	26	1.5	11.88	1.50	4.50	7.5	2.0	5C	11.00	10
Oversized	30	36	0.75	2.5	31	2.0	14.25	1.88	5.00	9.0	2.5	6C	13.50	12

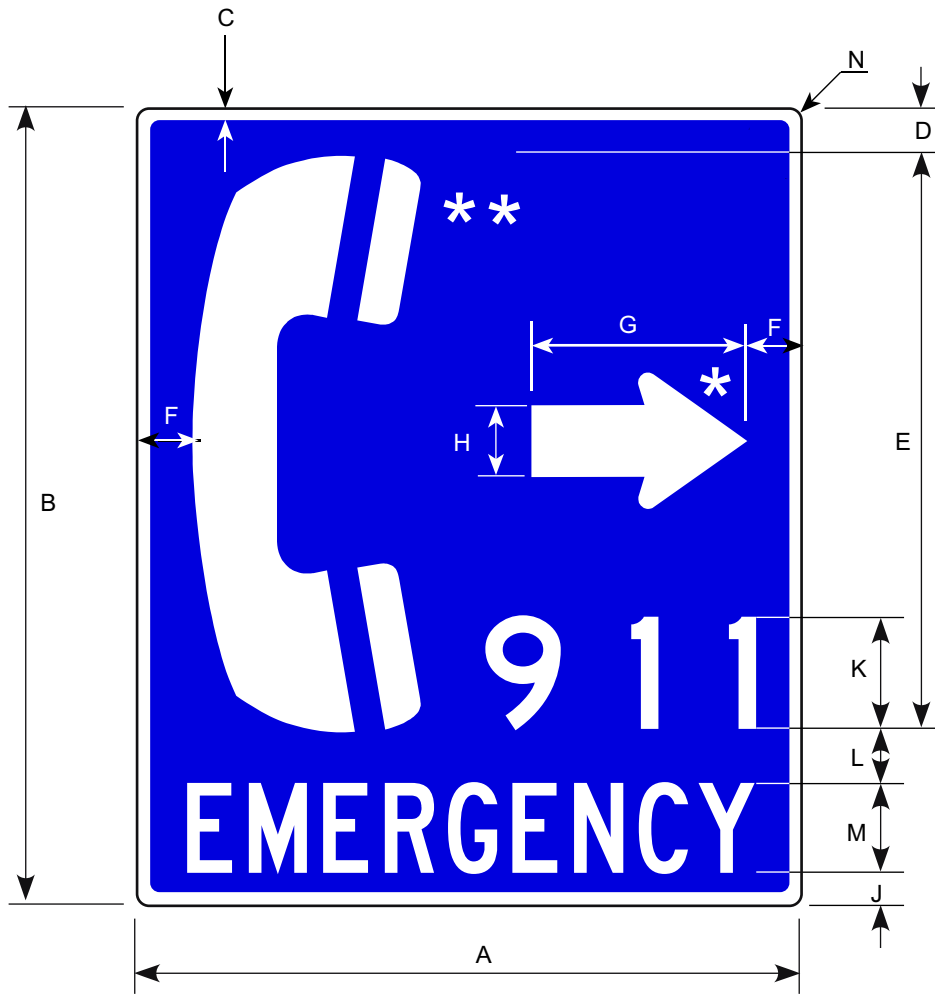

Border and Legend: White
Background: Blue

* See Appendix B-1 for Standard Arrow Details.

** Symbol and arrow reversible. Make symbol proportional to graphic shown.

Road Class	Dimensions (inches)												
	A	B	C	D	E	F	G	H	J	K	L	M	N
Conv & Min	30	36	0.63	2.0	26	2.5	10.5	2.63	1.5	5D	2.5	4C	1.5

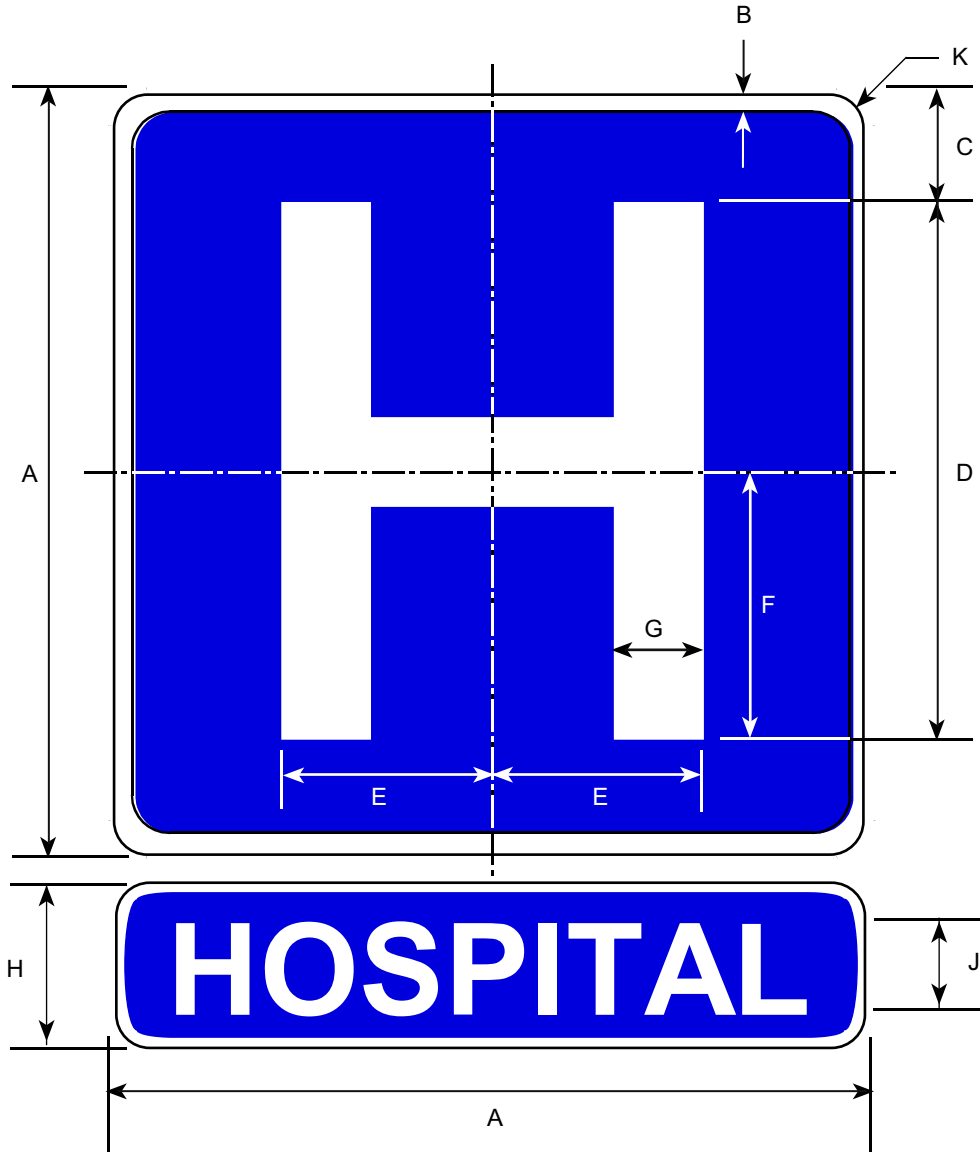

Border and Legend: White
Background: Blue

Make symbol proportional to graphic shown

Road Class	Dimensions (inches)									
	A	B	C	D	E	F	G	H	J	K
Conv/Min	24	0.50	4	16	6.38	8.38	3.2	6.0	3E	1.5
Oversized	30	0.75	5	20	8.0	10.38	4.0	8.0	4D	1.88

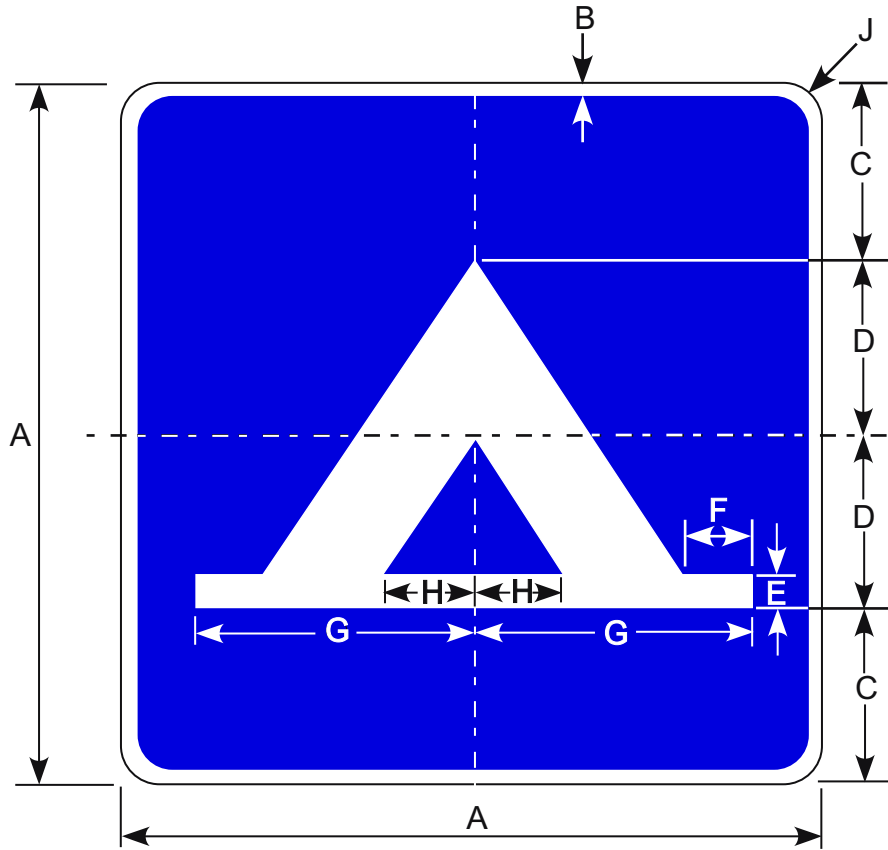

Border and Legend: White
Background: Blue

Make symbol proportional to graphic shown

Road Class	Dimensions (inches)								
	A	B	C	D	E	F	G	H	J
Conv/Min	24	0.50	6.0	6.0	1.13	2.25	9.50	3.25	1.50
Oversized	30	0.75	7.5	7.5	1.44	2.81	11.88	4.06	1.88

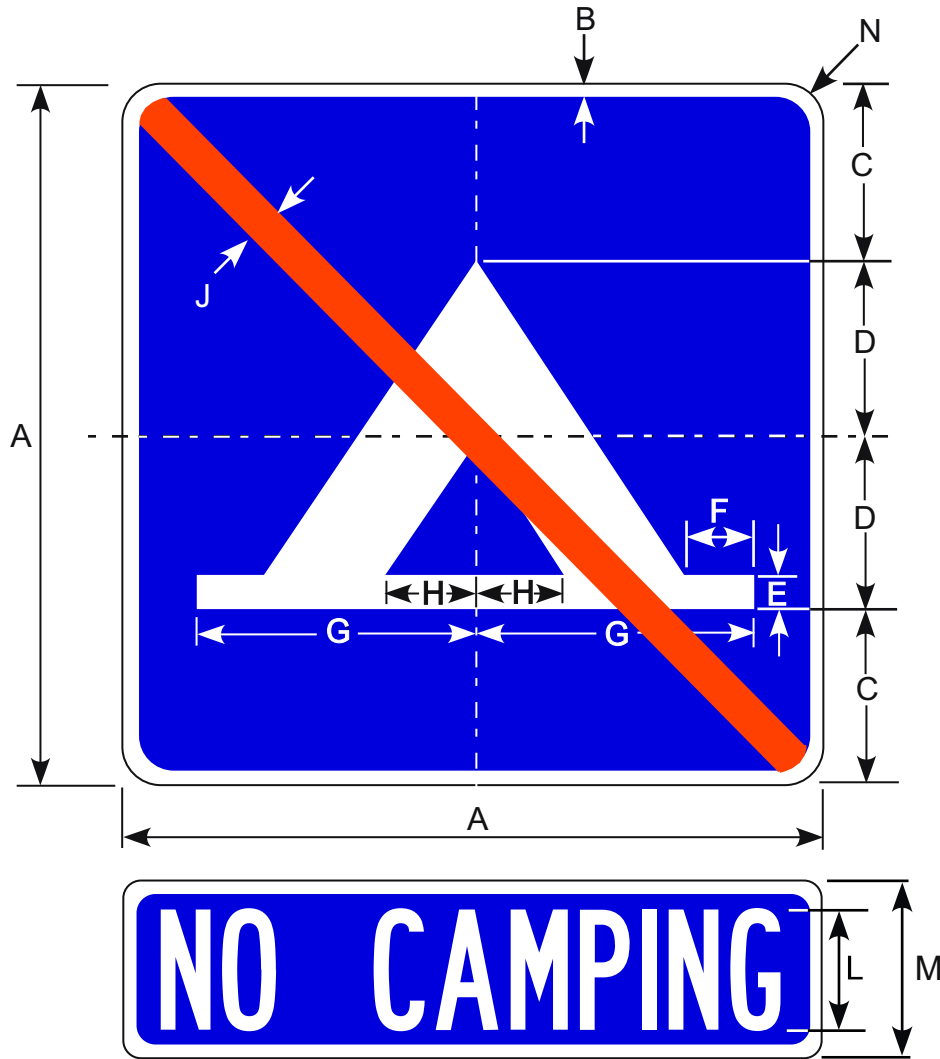

Border and Legend: White
 Background: Blue
 Cross Stripe: Red

Prior to the 2002 publication of this manual, this sign was numbered D9-3B.

Make symbol proportional to graphic shown
 Educational plaque optional.

Road Class	Dimensions (inches)											
	A	B	C	D	E	F	G	H	J	L	M	N
Con/Min	24	0.50	6.0	6.0	1.13	2.25	9.50	3.25	1.25	4B	6	1.50
Expressway	30	0.75	7.5	7.5	1.44	2.81	11.88	4.06	1.75	4B	6	1.88

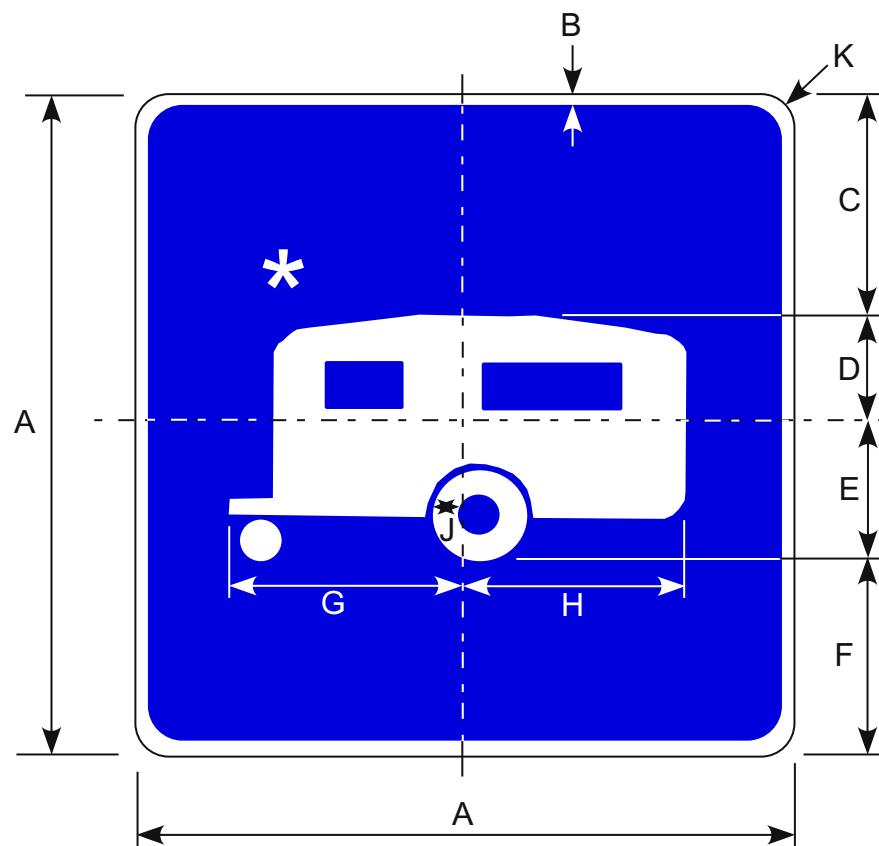

Border and Legend: White
Background: Blue

* Make symbol proportional to the graphic shown.

Prior to the 2002 publication of this manual, this sign was numbered D9-3A.

Road Class	Dimensions (inches)									
	A	B	C	D	E	F	G	H	J	K
Conv/Min	24	0.50	8	4	5.00	7.00	8.75	8.25	1.75	1.50
Special	30	0.75	10	5	6.25	8.75	10.94	10.32	2.19	1.88

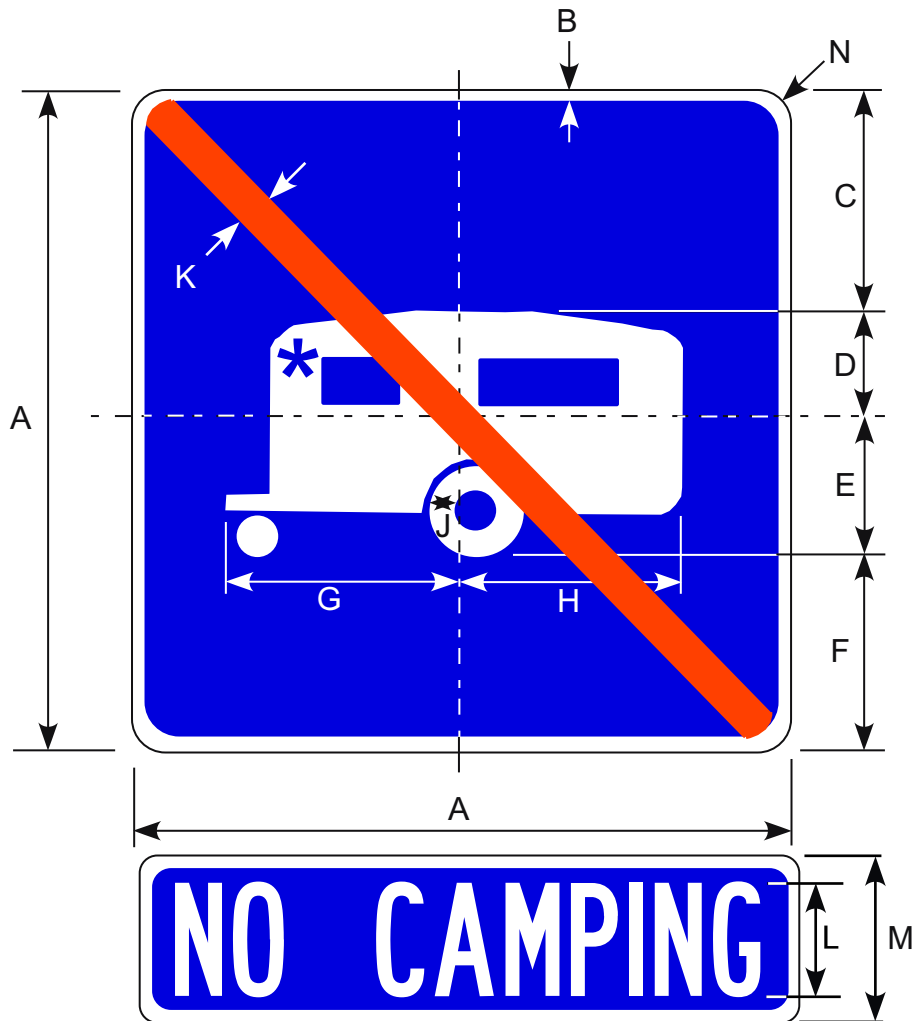

Border and Legend: White
 Background: Blue
 Cross Stripe: Red

* Make symbol proportional to graphic shown.

Prior to the 2002 publication of this manual, this sign was numbered D9-3C.

Educational plaque optional.

Road Class	Dimensions (inches)												
	A	B	C	D	E	F	G	H	J	K	L	M	N
Conv/Min	24	0.50	8	4	5.00	7.00	8.75	8.25	1.75	1.25	4B	6	1.50
Expressway	30	0.75	10	5	6.25	8.75	10.94	10.31	2.19	1.75	4B	6	1.88

D9-13B

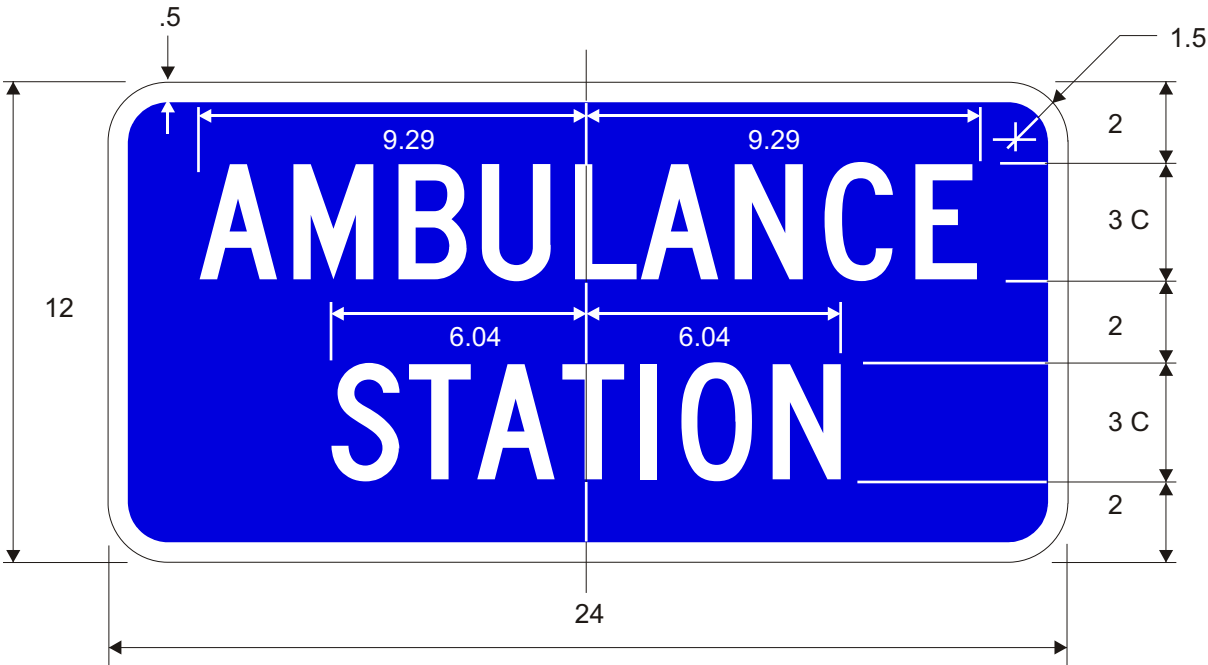

Border and Legend: White
Background: Blue

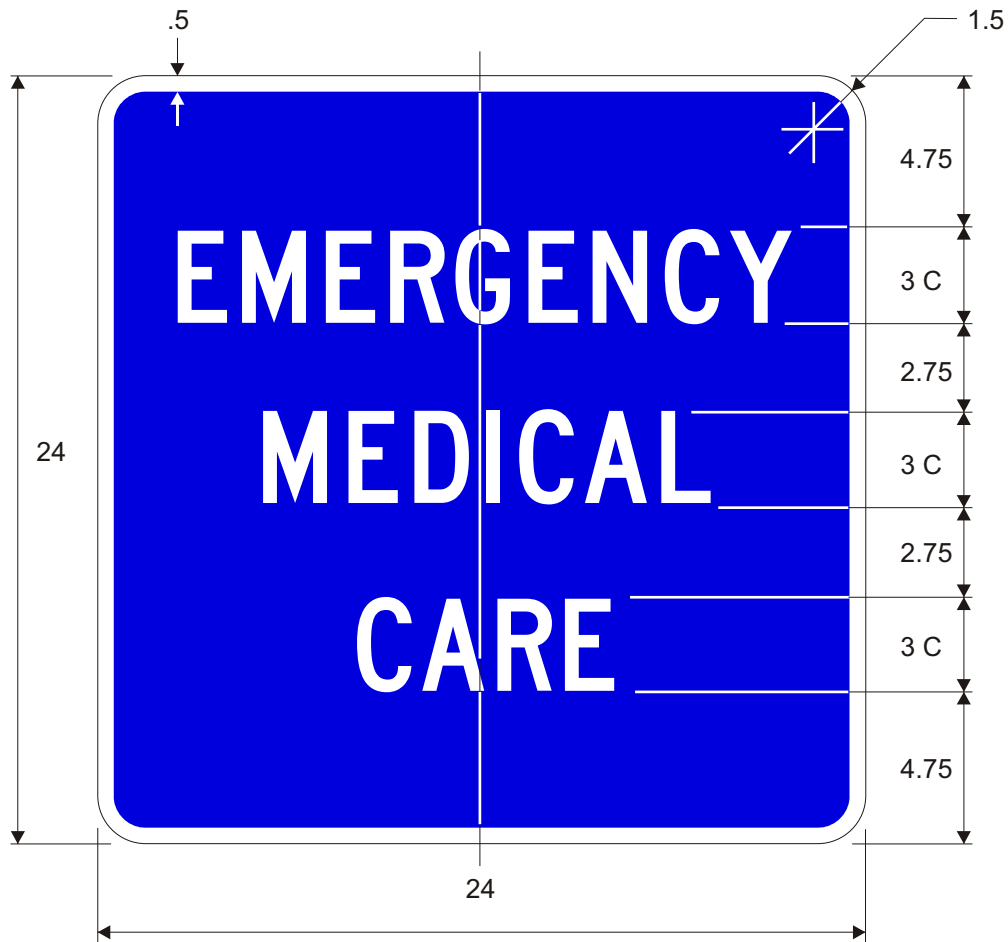

Border and Legend: White
Background: Blue

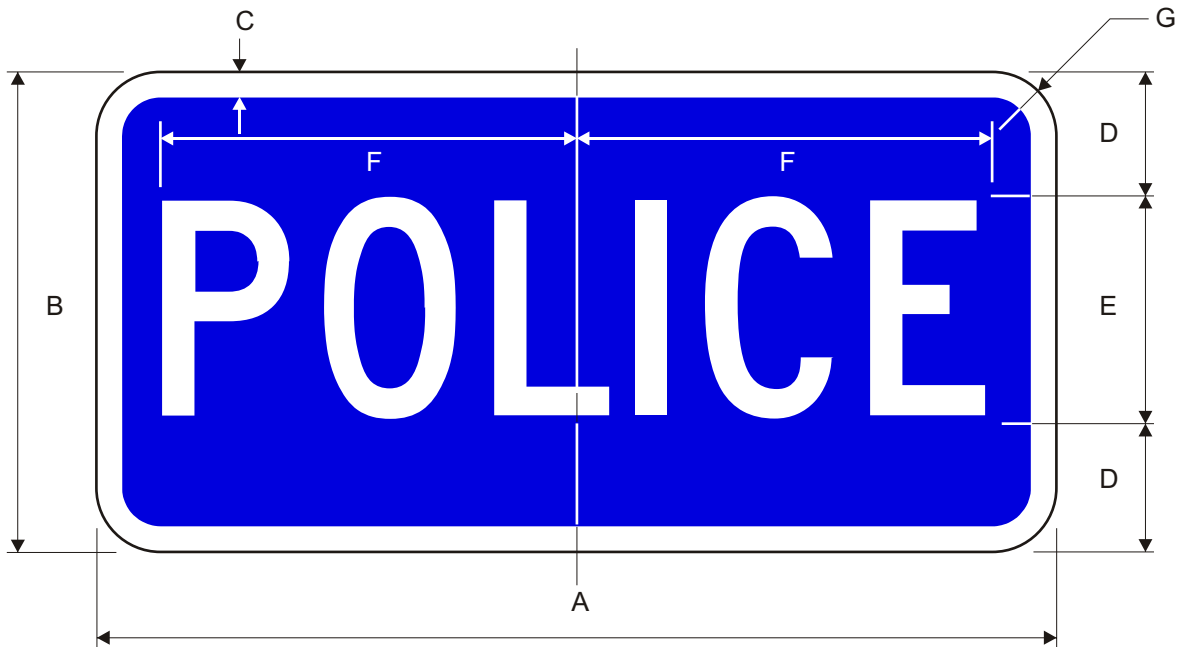

Border and Legend: White
 Background: Blue

Road Class	Dimensions (inches)						
	A	B	C	D	E	F	G
Conv/Min	24	12	0.50	3.0	6C	10.38	1.5
Expy	30	15	0.50	3.5	8C	13	1.5

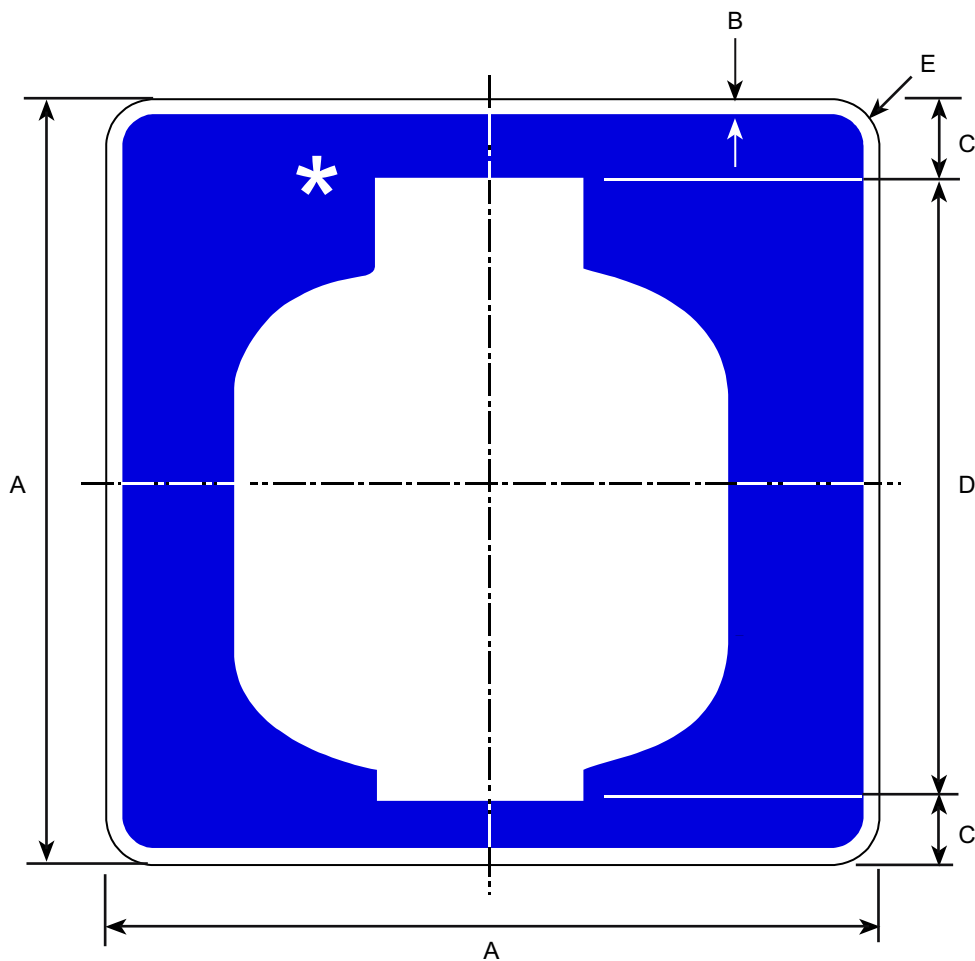

Border and Legend: White
Background: Blue

* Make symbol proportional to graphic shown

Road Class	Dimensions (inches)				
	A	B	C	D	E
Conventional	24	0.50	2.0	20	1.50
Oversized	30	0.75	2.5	25	1.88

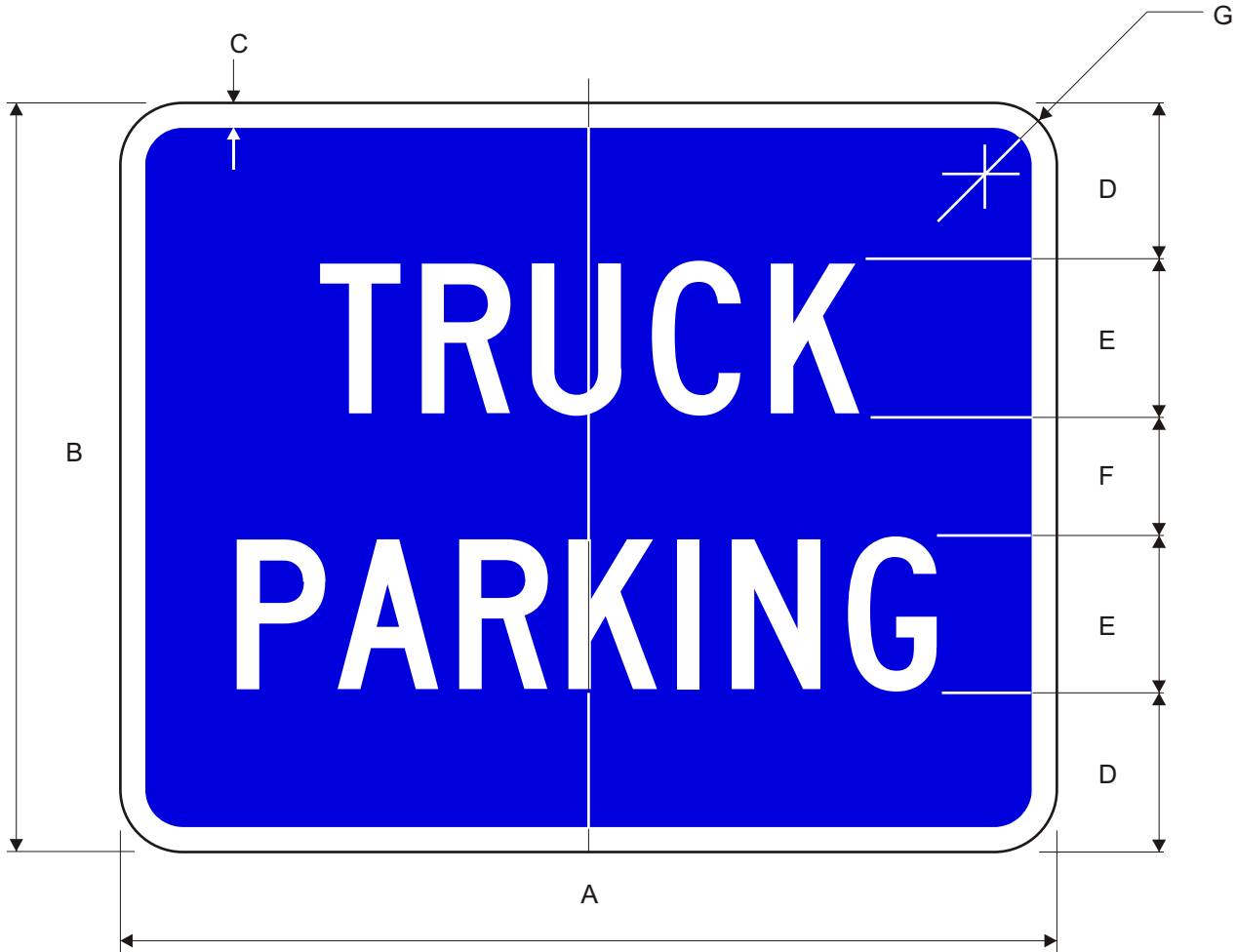

Border and Legend: White
 Background: Blue

Road Class	Dimensions (inches)						
	A	B	C	D	E	F	G
Conv/Min	24	18	0.50	3.5	4C	3.0	1.5
Expy	30	24	0.75	5.13	5C	3.75	1.88

D9-18 D9-18A

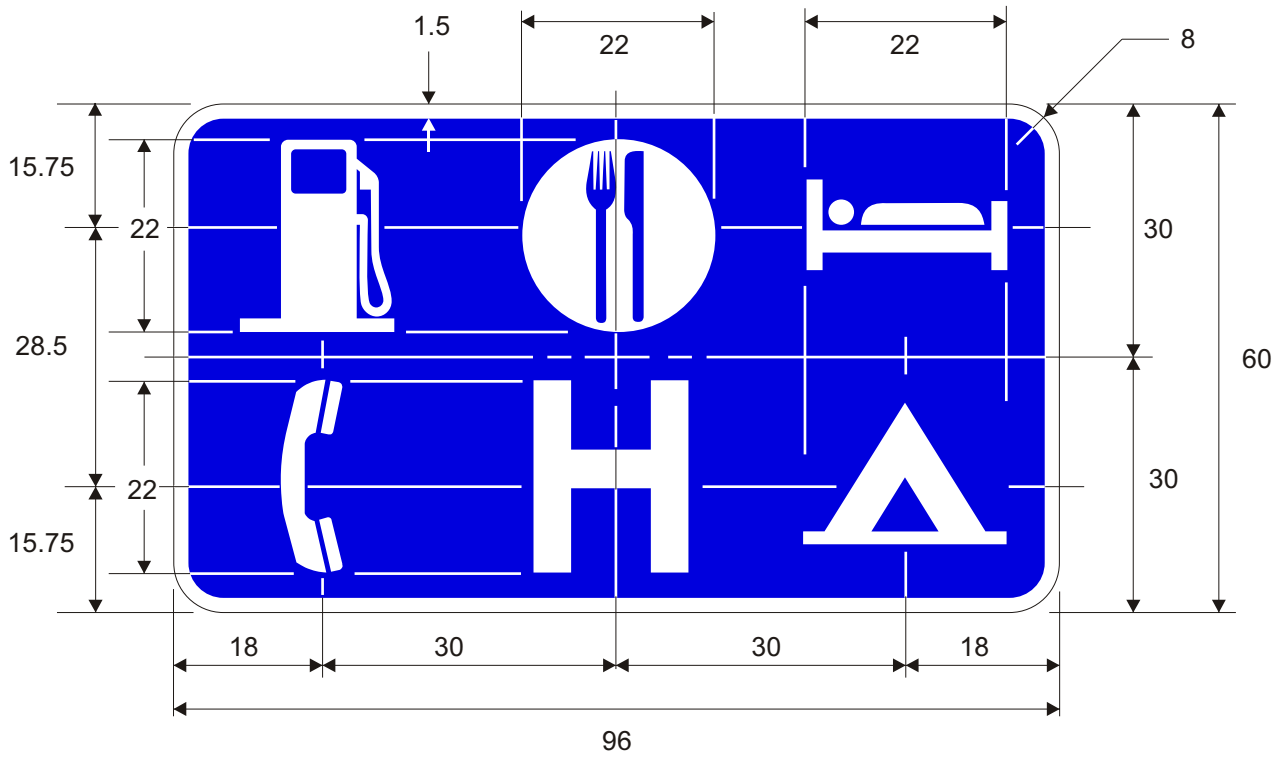

D9-18

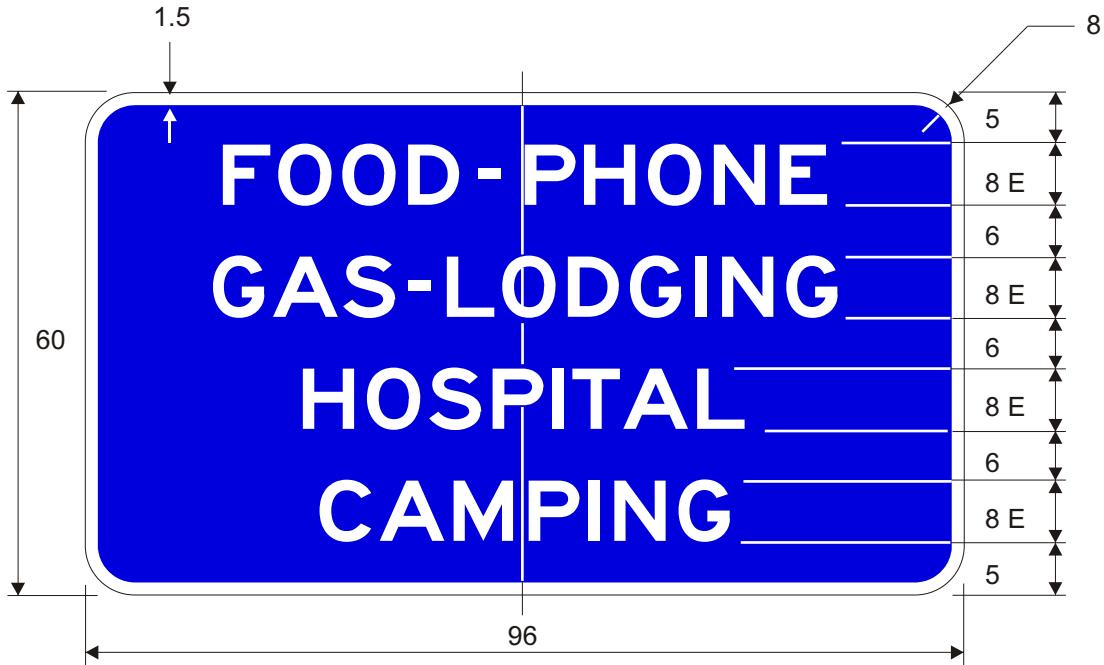

D9-18A

Border and Legend: White
Background: Blue

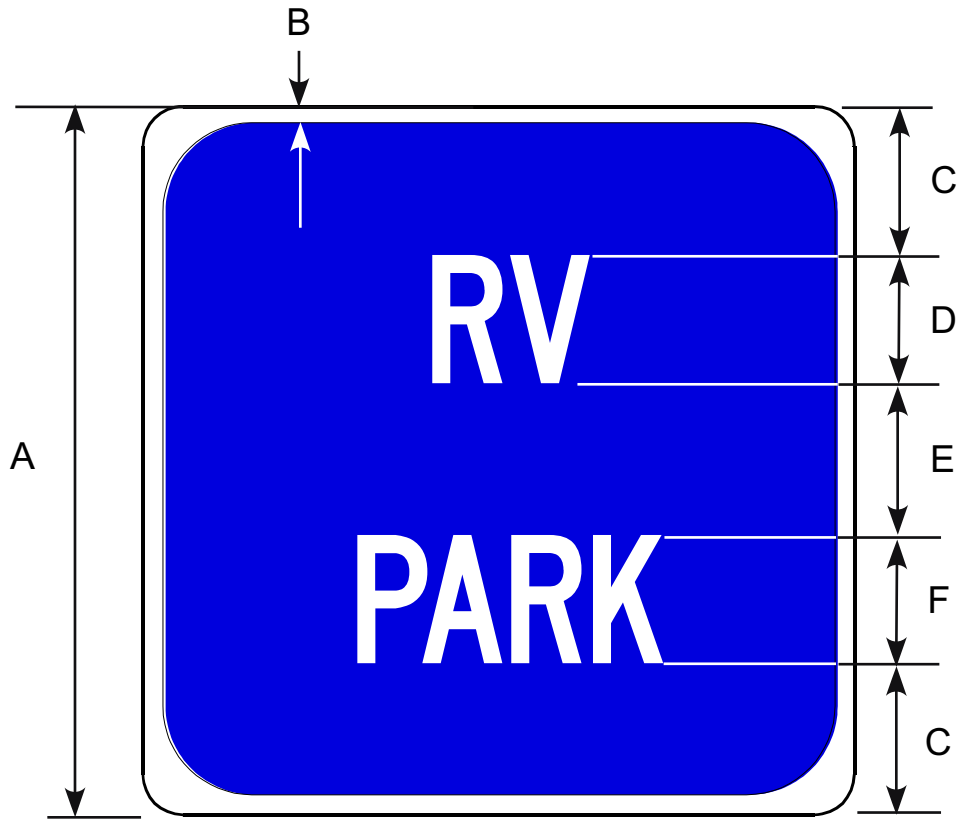

Border and Legend: White
Background: Blue

Road Class	Dimensions (inches)					
	A	B	C	D	E	F
Conv/Min	24	0.50	5.0	5E	4	5D
Expressway	30	0.75	3.5	7E	3	7D

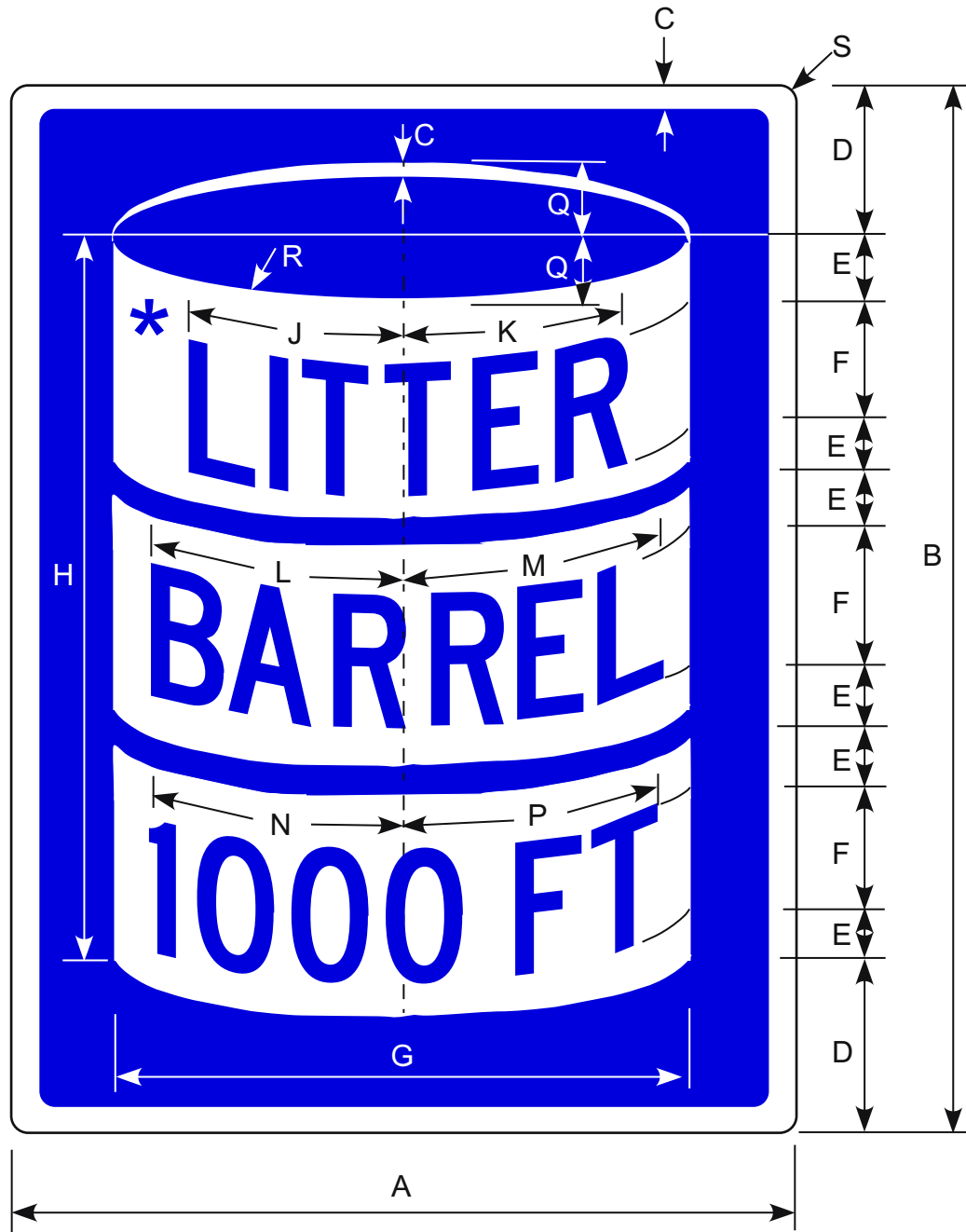

Border and Legend: White
Background: Blue

* Make symbol proportional to graphic shown.

Prior to the 2002 publication of this manual, this sign was numbered D9-4.

Road Class	Dimensions (inches)																
	A	B	C	D	E	F	G	H	J	K	L	M	N	P	Q	R	S
Conv/Mn	24	30	0.63	4.5	1.5	4C	18	21	6.63	7.0	8.25	8.5	7.5	8.0	2.0	17	1.5
Oversized	36	48	1.0	9.0	2.0	6C	24	30	10	10.5	12.38	12.75	11	11.5	3.0	17	2.25

D9-104

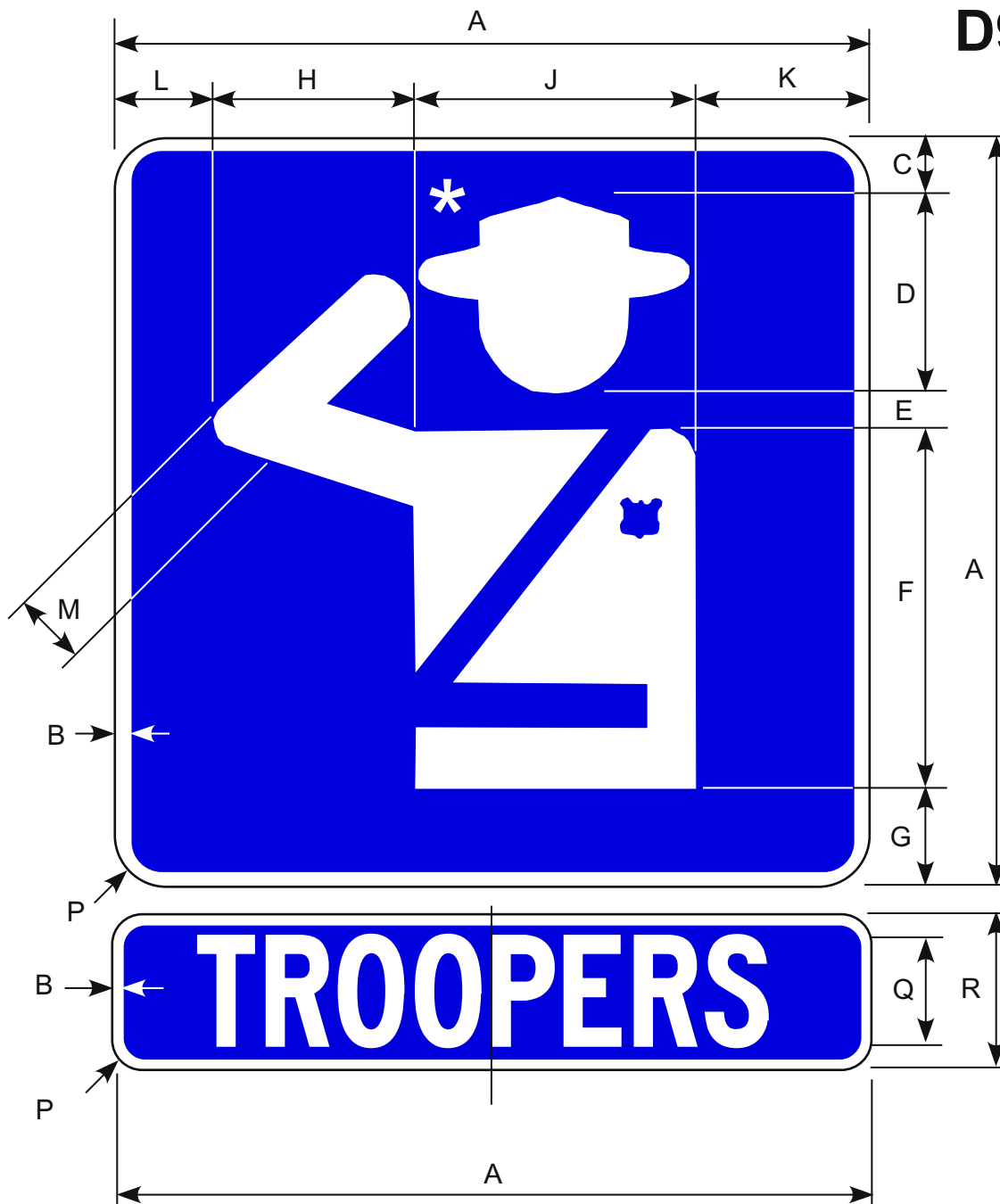

Border and Legend: White
Background: Blue

* Make symbol proportional to graphic shown.

Prior to the 2002 publication of this manual, this sign was numbered D9-15.

Educational plaque optional.

Road Class	Dimensions (inches)															
	A	B	C	D	E	F	G	H	J	K	L	M	P	Q	R	
Conv/Mn	24	0.50	1.81	6.44	1.06	11.63	3.06	6.38	9.0	5.0	3.63	2.25	1.5	4B	6.0	
Oversized	30	0.75	2.25	8.0	1.38	14.5	3.88	8.0	11.25	6.75	4.0	2.75	1.88	4C	6.0	

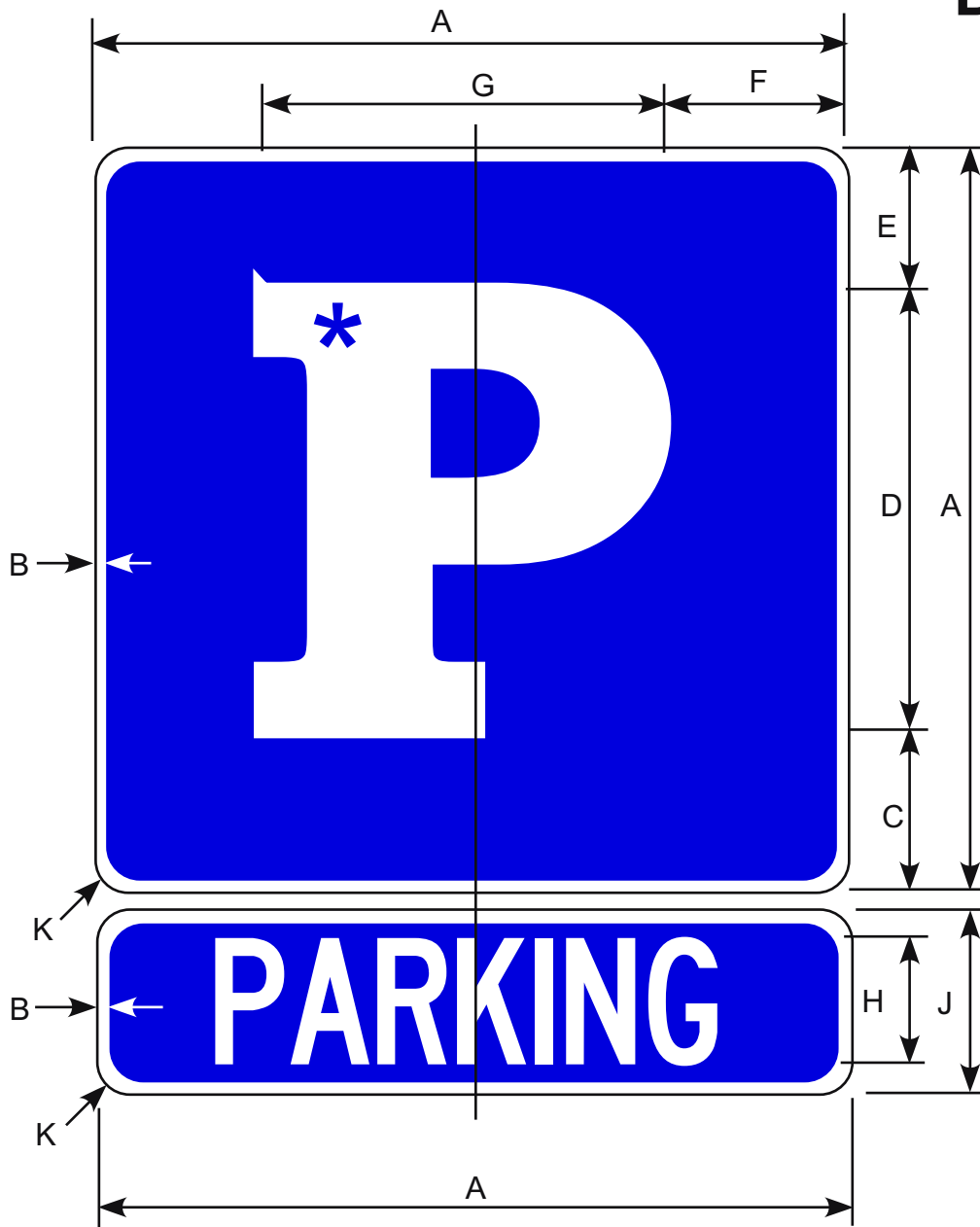

Border and Legend: White
Background: Blue

* Make symbol proportional to graphic shown

Prior to the 2002 publication of this manual, this sign was numbered D9-14.

Educational plaque optional.

Road Class	Dimensions (inches)									
	A	B	C	D	E	F	G	H	J	K
Conv/Min	24	0.50	4.63	15.56	3.81	4.94	14.13	4B	6.0	1.5
Oversized	30	0.75	5.81	19.44	4.75	6.0	18	4C	6.0	1.88

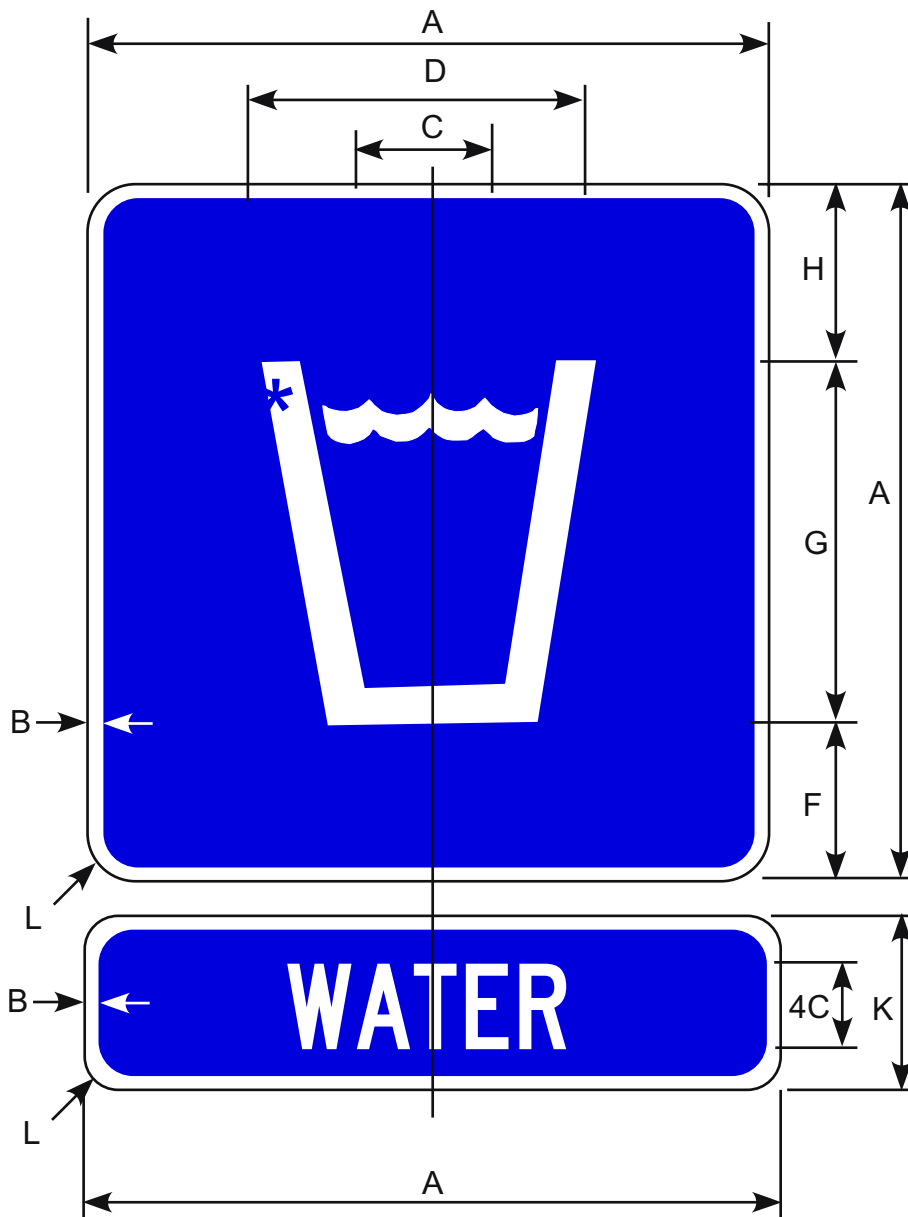

Border and Legend: White
Background: Blue

* Make symbol proportional to graphic shown.

Prior to the 2002 publication of this manual, this sign was numbered D9-13.

Educational plaque optional.

Road Class	Dimensions (inches)									
	A	B	C	D	F	G	H	J	K	L
Conv/Min	24	0.50	7.38	11.69	5.25	12.63	6.12	4B	6.0	1.5
Oversized	30	0.75	9.25	14.63	6.56	15.75	7.69	4C	6.0	1.88

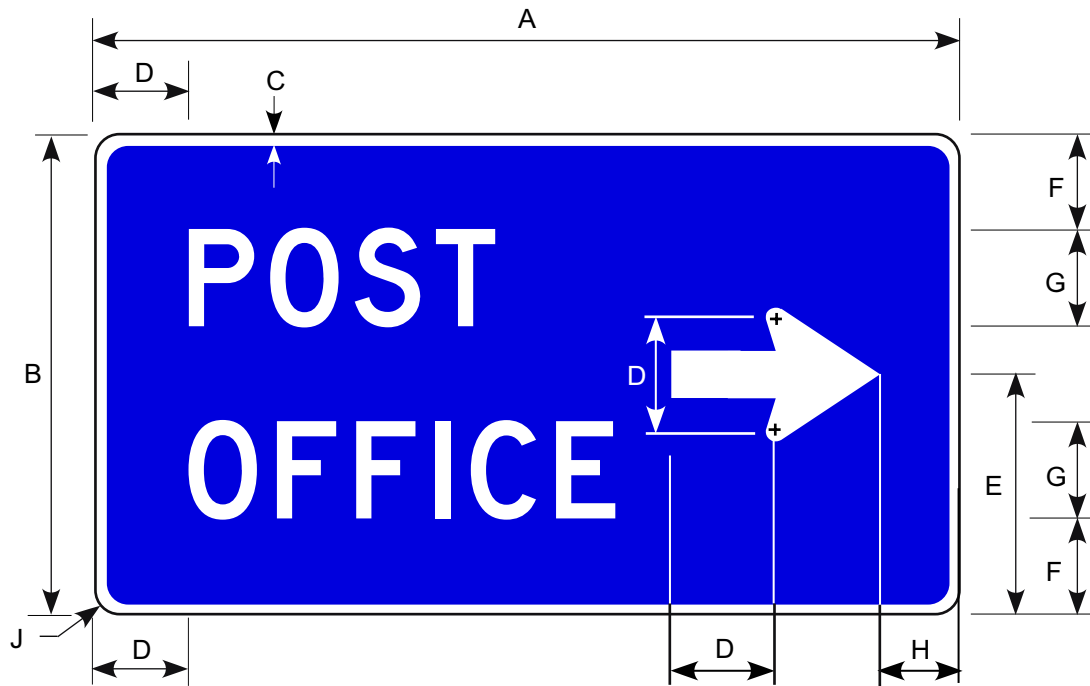

Border and Legend: White
Background: Blue

See Appendix B-1 for Standard Arrow Details.

Prior to 2002 publication of this manual,
this sign was numbered D9-19.

Road Class	Dimensions (inches)								
	A	B	C	D	E	F	G	H	J
Minimum	36	24	0.63	4.0	12	6.0	4D	2.75	1.5
Conventional	54	30	0.75	6.0	15	6.0	6D	4.88	1.88
Expressway	72	36	0.88	8.0	18	6.0	8D	6.88	2.25
Oversized	90	48	1.25	10	24	9.0	10D	8.88	3.0



Border and Legend: White
Background: Blue

Prior to 2001 publication of this manual,
this sign was numbered D9-19C.

Road Class	Dimensions (inches)							
	A	B	C	D	E	F	G	H
Minimum	48	24	0.63	5.75	6.0	4D	4.0	1.5
Conventional	66	30	0.75	6.0	6.0	6D	6.0	1.88
Expressway	90	36	0.88	8.5	6.0	8D	8.0	2.25
Oversized	114	48	1.25	11.5	9.0	10D	10	3.0

D9-201

D9-202

D9-203



D9-201



D9-202



D9-203

Border and Legend: White
Background: Blue

Road Class	Letter Size	Dimensions (Inches)			Border Width
		D9-201	D9-202	D9-203	
Conventional	8E	120 X 84	120 X 48	96 X 48	1.5
Expwy/Fwy	10E	144 X 108	144 X 60	120 X 60	2.0

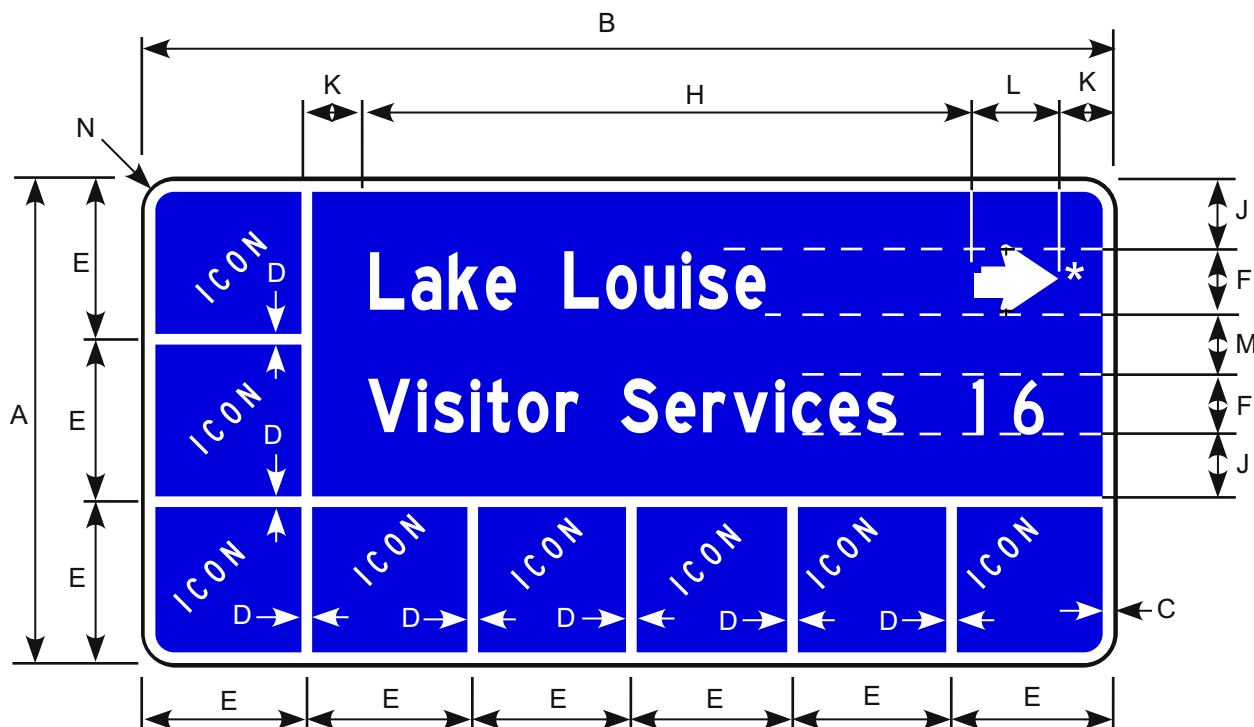

Border and Legend: White
Background: Blue

* Arrow should always be placed near the outer edge of the sign, icons should be placed on other side of sign. See Appendix B-1 for Standard Arrow Details.

Reverse sign layout for left or up arrow.

Road Class	Dimensions (inches)												
	A	B	C	D	E	F	G	H	J	K	L	M	N
Conv & Min	54	108	1.25	1	18	7C	2.0	VAR	8	5	9.75	7.00	3.38

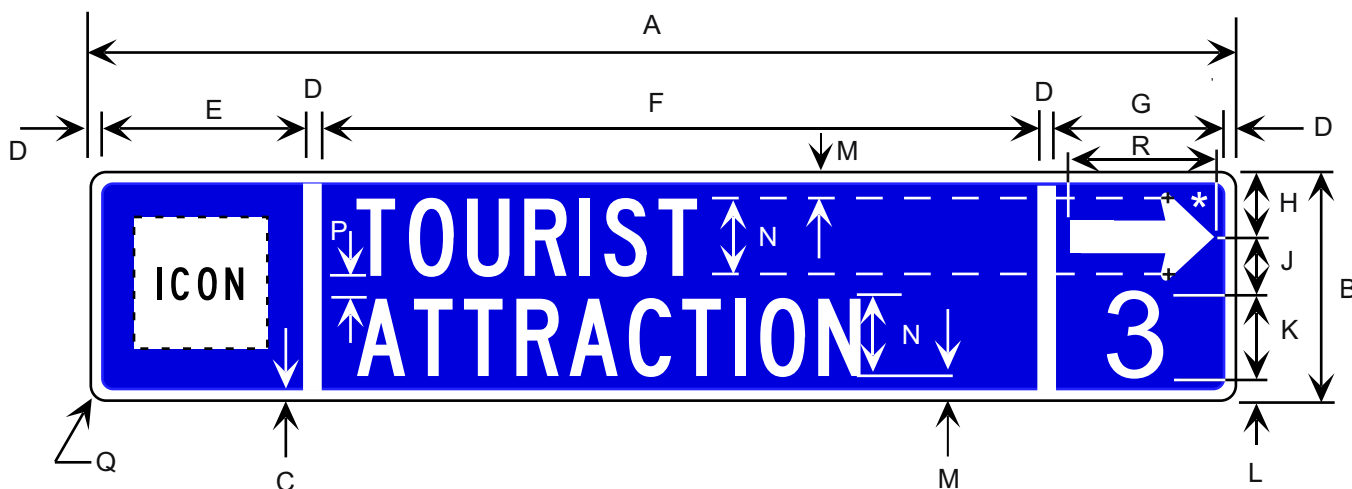

Border and Legend: White
Background: Blue

*See Appendix B-1 for Standard Arrow Details.

NOTES:

This is a Tourist Orient Directional Sign (TODS).

- 1) The length of legend on any one line shall not exceed 54 inches.
- 2) Up to three TODS panels may be placed (with a two inch vertical separation) on one set of sign supports.
- 3) When arrows on multiple panels point in different directions, the panels shall be arranged as follows starting from the top:
Arrow Up, Arrow Left, Arrow Right.
- 4) When arrows on multiple panels point in the same direction, the top panel shall show the nearest business and the bottom panel shall show the most distant.
- 5) * 6" series C letters may be used when the legend will not fit with series D.
- 6) If attraction is adjacent to roadway, delete mileage and center arrow in space.

Road Class	Dimensions (inches)																
	A	B	C	D	E	F	G	H	J	K	L	M	N	P	Q	R	
Conv & Min	90	18	0.75	0.75	16	60	11	5.38	4.63	6D*	2	2	6D	2	1.5	9	

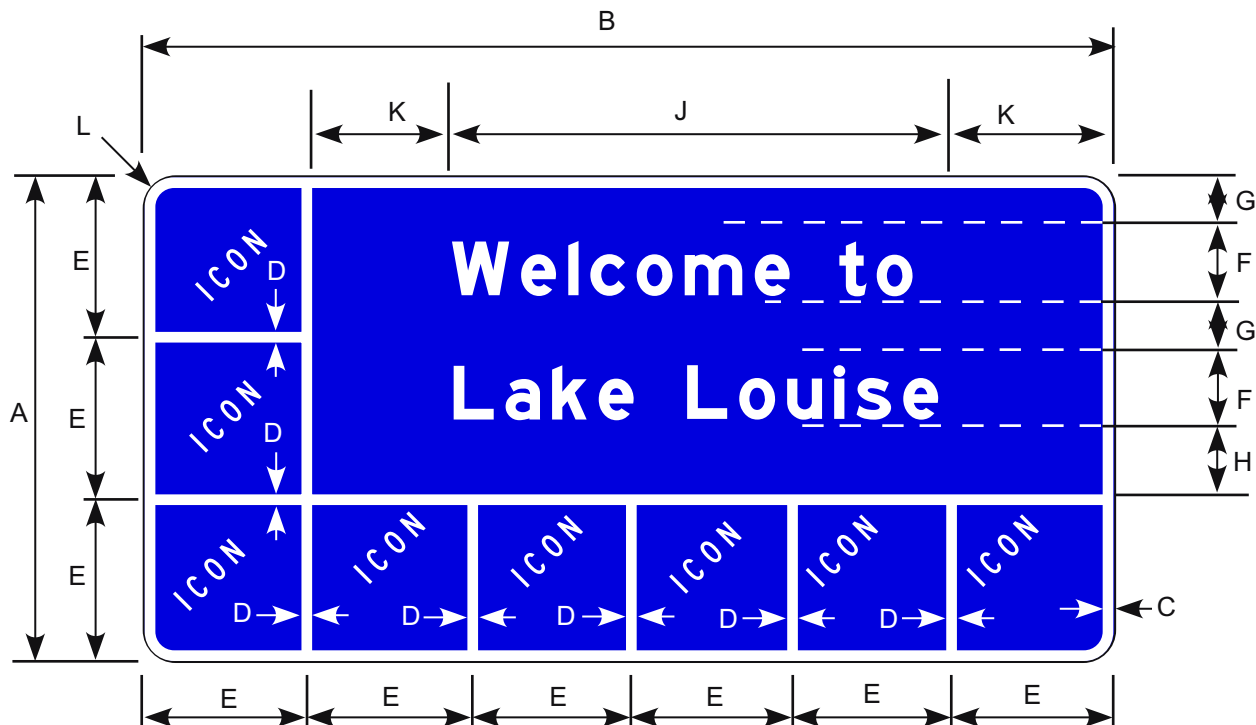

Border and Legend: White
Background: Blue

Road Class	Dimensions (inches)										
	A	B	C	D	E	F	G	H	J	K	L
Conv&	54	108	1.25	1	18	10C	5	6.0	VAR	VAR	3.38

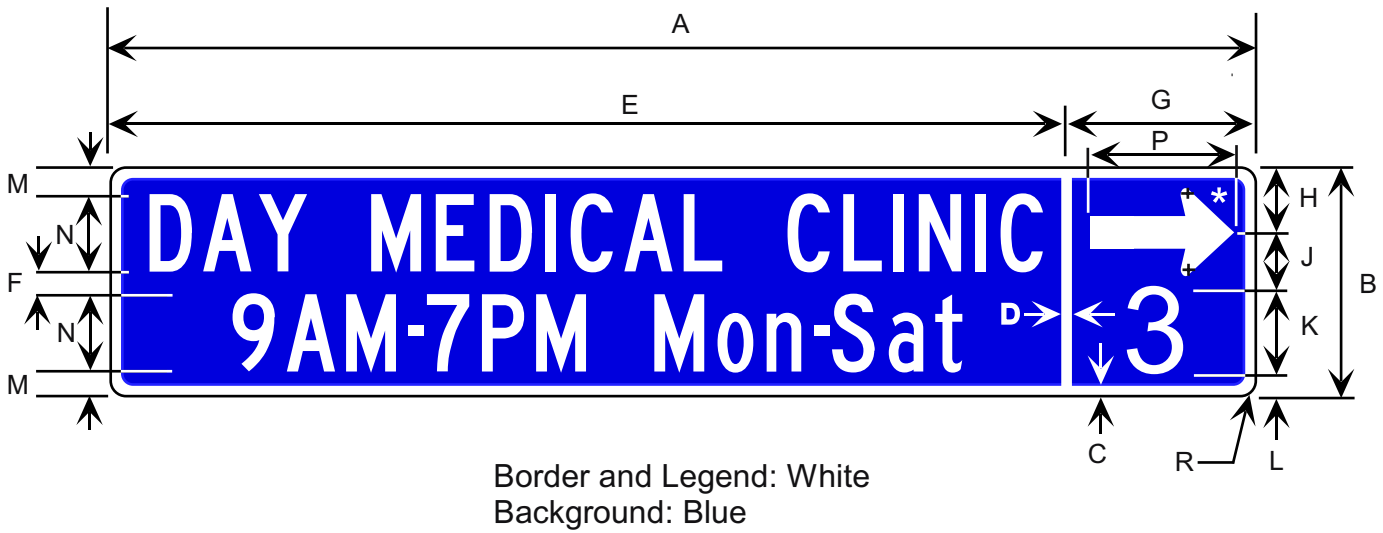

*See Appendix B-1 for Standard Arrow Details.

Road Class	Dimensions (inches)															
	A	B	C	D	E	F	G	H	J	K	L	M	N	P	R	
Conv & Min	90	18	0.75	0.75	78	2	12	5.37	4.63	6D	2	2	6C	9	1.5	

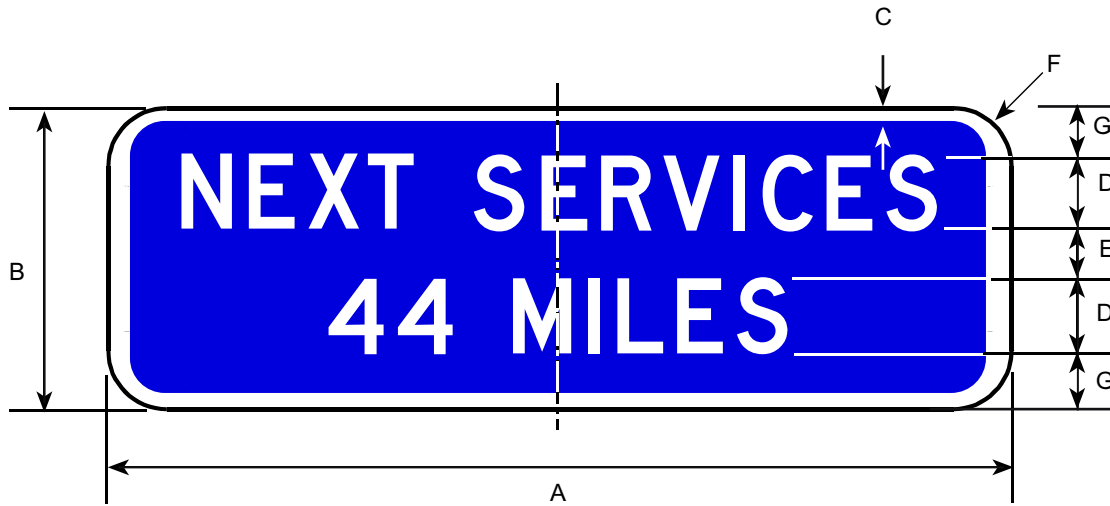

Border and Legend: White
 Background: Blue

Road Class	Dimensions (inches)						
	A	B	C	D	E	F	G
Conv/Min	72	24	1.25	6D	3.0	4	4.50
Oversized	96	36	1.50	8D	5.5	6	7.25

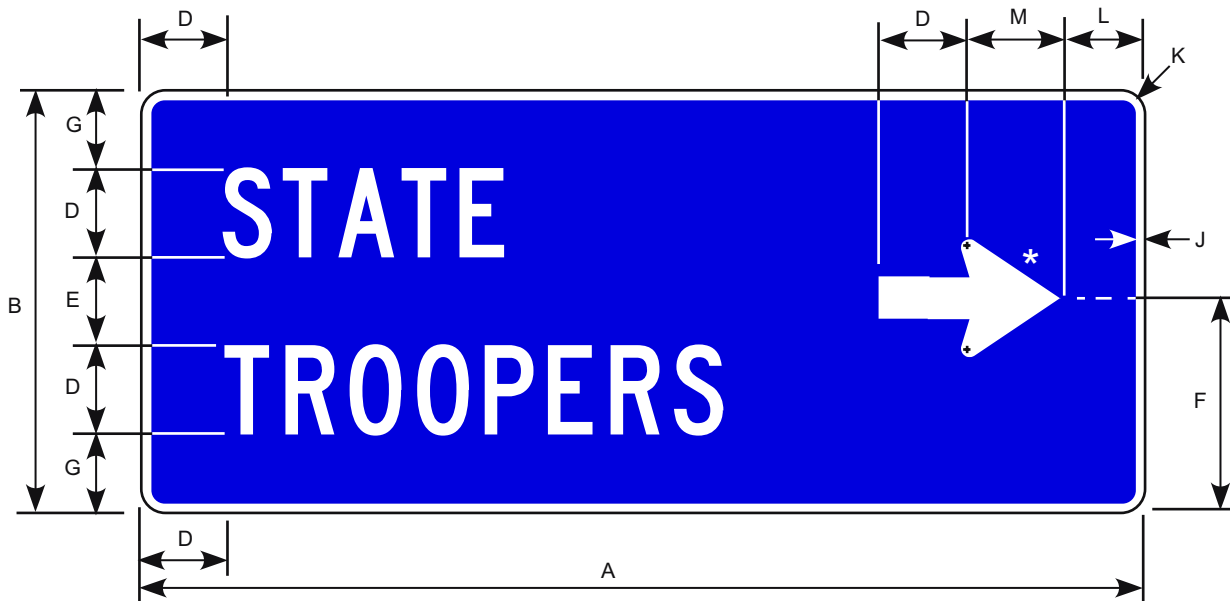

Border and Legend: White
Background: Blue

Prior to the 2002 publication of this manual,
this sign was numbered D9-18.

*See Appendix B-1 for Standard Arrow Details.

Road Class	Dimensions (inches)								
	A	B	D	E	F	G	J	K	L
Minimum	48	24	4E	4.0	12	6.0	0.63	1.5	2.75
Conventional	66	30	6E	6.0	15	6.0	0.75	1.88	4.88
Expressway	90	36	8E	8.0	18	6.0	0.88	2.25	6.88
Freeway	114	48	10E	10	24	9.0	1.25	3.0	8.88

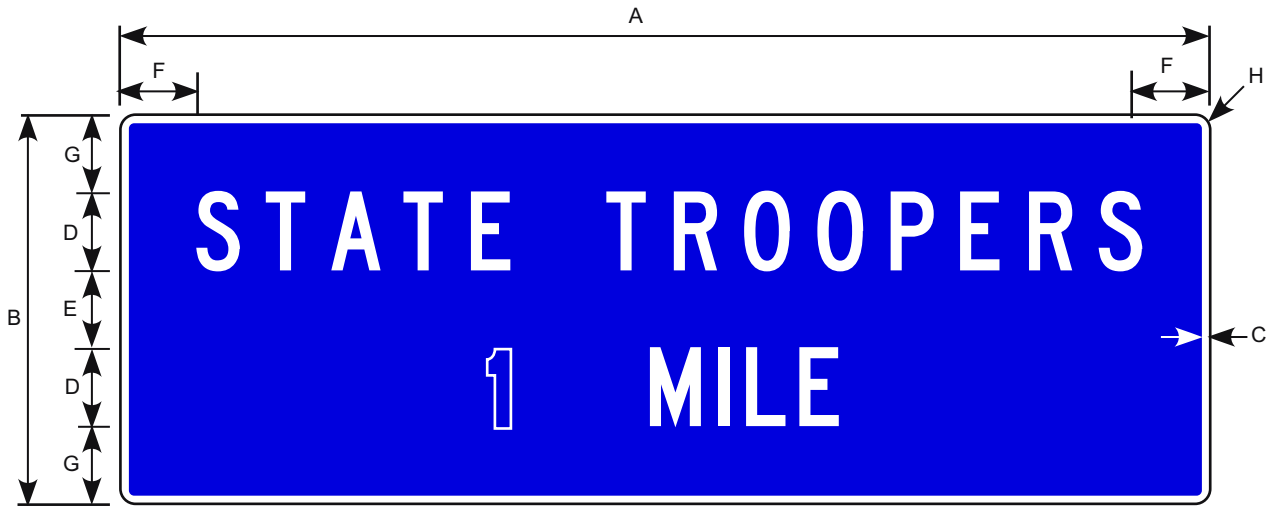

Border and Legend: White
Background: Blue

Prior to the 2002 publication of this manual,
this sign was numbered D9-18C.

Road Class	Dimensions (inches)							
	A	B	C	D	E	F	G	H
Minimum	60	24	0.63	4E	4.0	6.0	6.0	1.5
Conventional	84	30	0.75	6E	6.0	6.0	6.0	1.88
Expressway	114	36	0.88	8E	8.0	8.75	6.0	2.25
Freeway	144	48	1.25	10E	10	11.75	9.0	3.0

D9-230

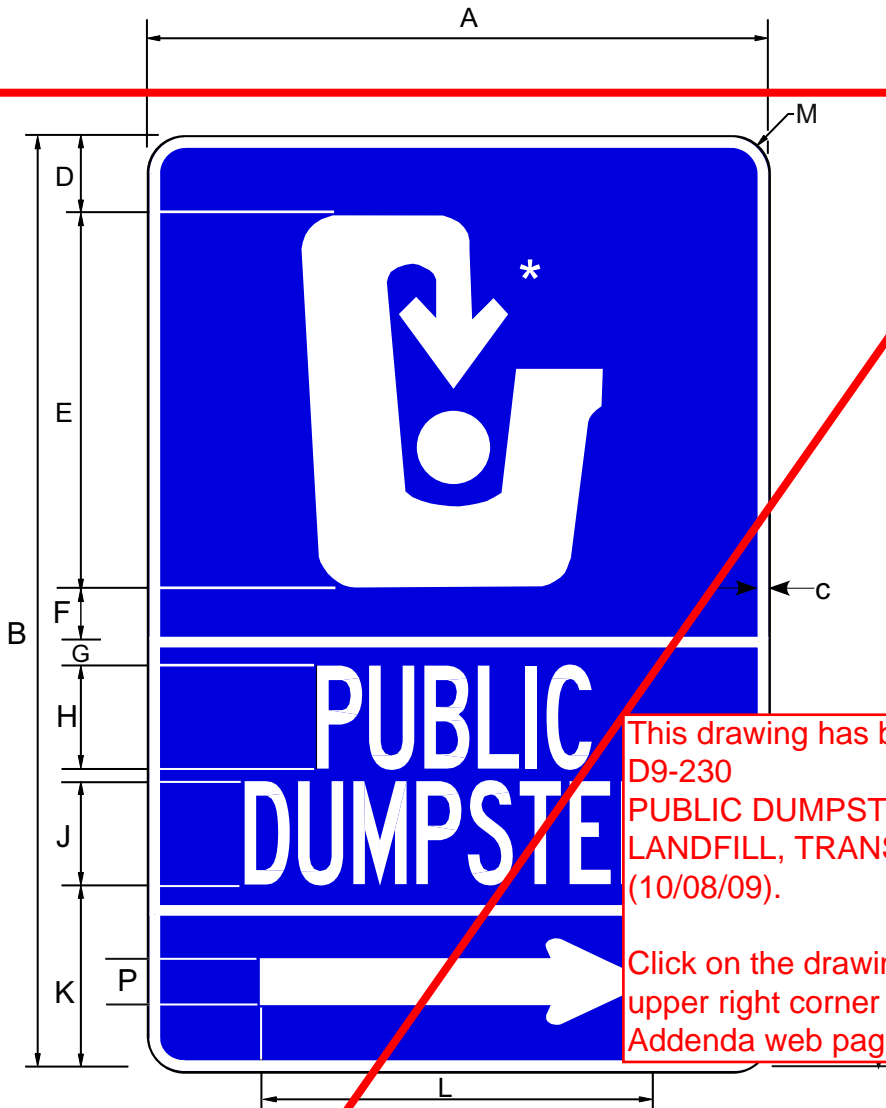

This drawing has been replaced with:
 D9-230
 PUBLIC DUMPSTER (SANITARY
 LANDFILL, TRANSFER SITE)
 (10/08/09).
 Click on the drawing number in the
 upper right corner to go to the Interim
 Addenda web page.

Border and Legend: White
 Background: Blue
 Circle in Dumpster: White

* Make symbol proportional
 to graphic shown.

** See Appendix B-1 for Standard Arrow Details.

Road Class	Dimensions (inches)													
	A	B	C	D	E	F	G	H	J	K	L	M	N	P
Conv & Min	24	36	0.63	3.12	14.38	2.0	0.5	4B	4.5	7.13	15	1.5	6.0	1.5

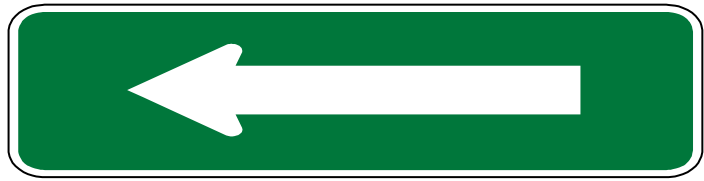
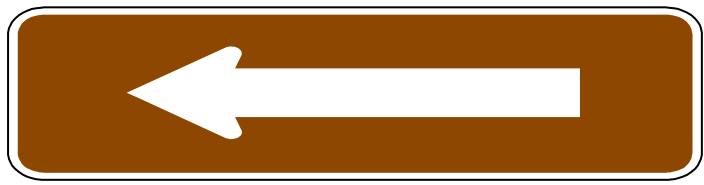
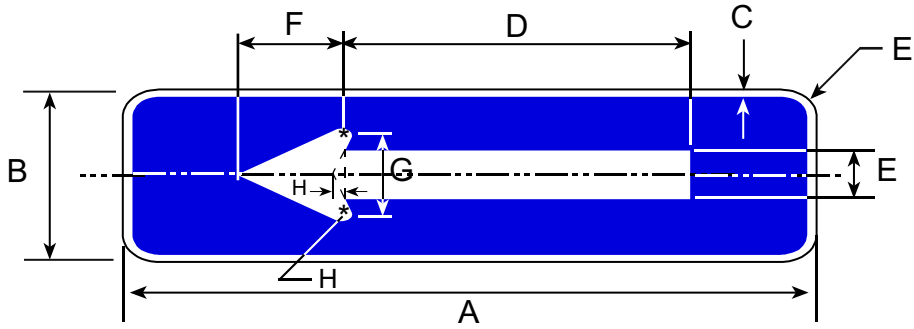

* See Appendix B-1 for Standard Arrow Details.

Border and Legend: White
 Background: Blue or Brown or Green

Road Class	Dimensions (inches)							
	A	B	C	D	E	F	G	H
Conventional	24	6.0	0.5	12	1.5	3.0	3.5	0.25

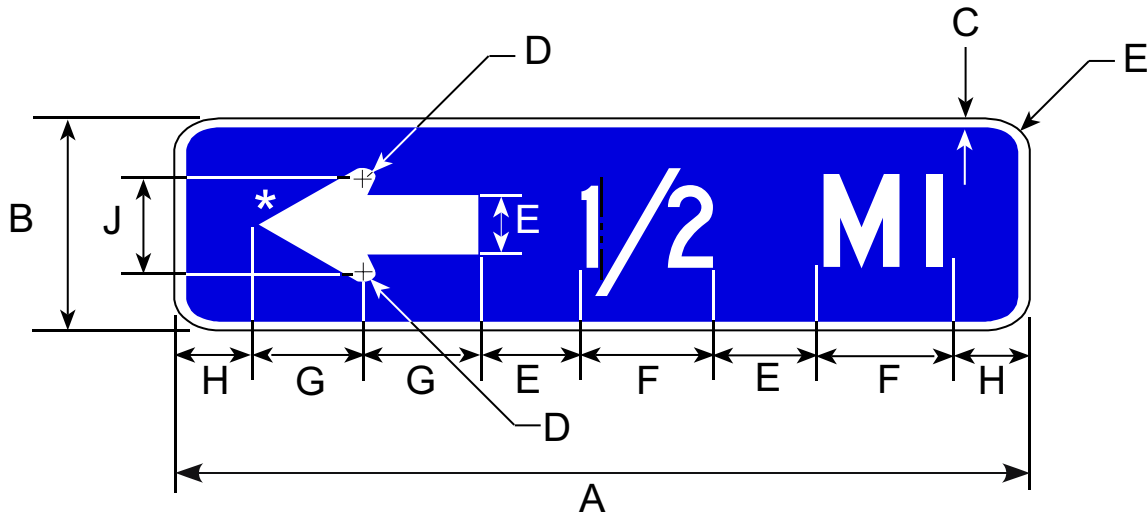

Border and Legend: White
Background: Blue or Brown

Note: Use 4" Series C for cap, 4" Series C numerals or 3" Series C fraction (shown).

* See Appendix B-1 for Standard Arrow Details.

Road Class	Dimensions (inches)								
	A	B	C	D	E	F	G	H	J
Conventional	24	6.0	0.5	0.25	2±	5.0	3.0	2.0	3.5

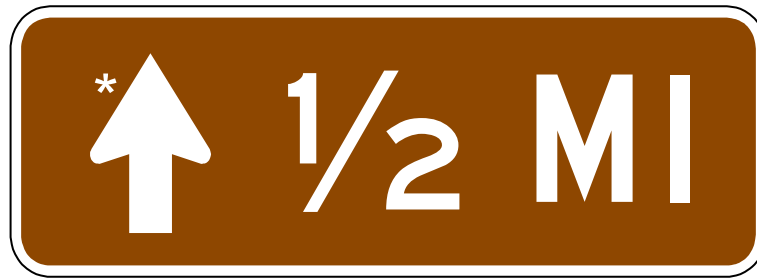
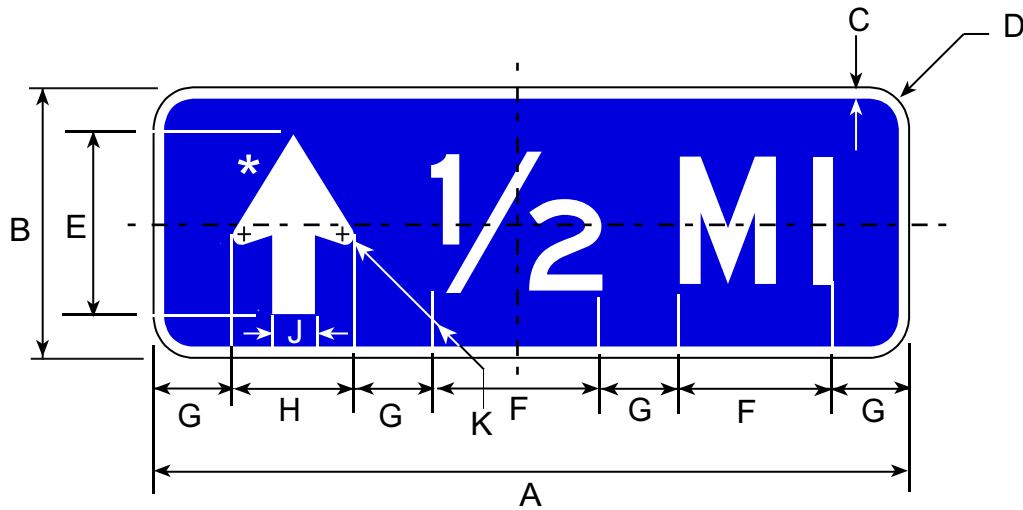

Border and Legend: White
Background: Blue or Brown

Note: Use 4" Series C for Caps, 4" Series C Numerals, or 3" Series C Fraction (shown).

* See Appendix B-1 for Standard Arrow Details.

Road Class	Dimensions (inches)									
	A	B	C	D	E	F	G	H	J	K
Conventional	24	9	0.38	1.5	6.0	5.0	2.5	4.0	1.5	0.25

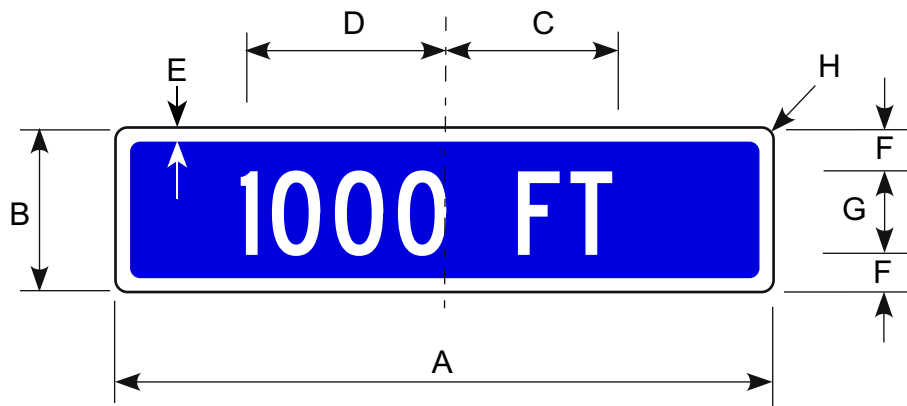

Border and Legend: White
 Background: Blue or Brown

Prior to the 2002 publication of this manual,
 this sign was numbered D9-B.

Road Class	Dimensions (inches)							
	A	B	C	D	E	F	G	H
Conv & Min	24	6	9.5	10	0.5	1	4C	1.5

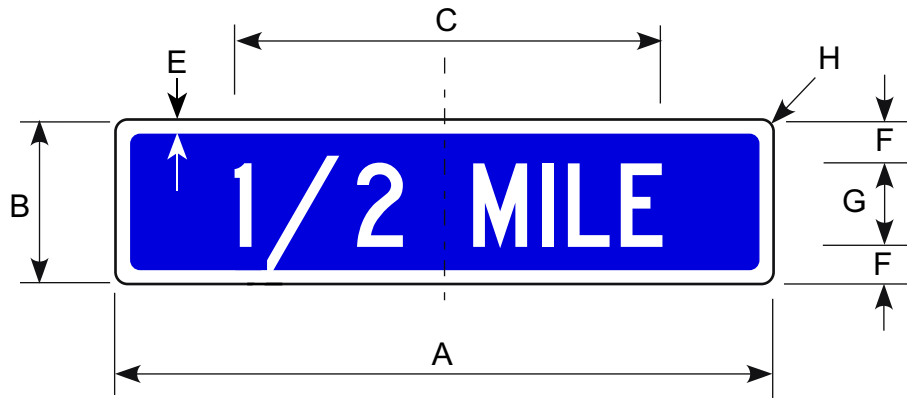

Border and Legend: White
 Background: Blue or Brown

Prior to the 2002 publication of this manual,
 this sign was numbered D9-D.

Road Class	Dimensions (inches)						
	A	B	C	E	F	G	H
Conv & Min	24	6	19.50	0.5	1	4C	1.5



Border and Legend: White
 Background: Blue or Brown

Prior to the 2002 publication of this manual,
 this sign was numbered D9-C.

Road Class	Dimensions (inches)						
	A	B	C	E	F	G	H
Conv & min	24	6.00	13.13	0.50	1.00	4C	1.50

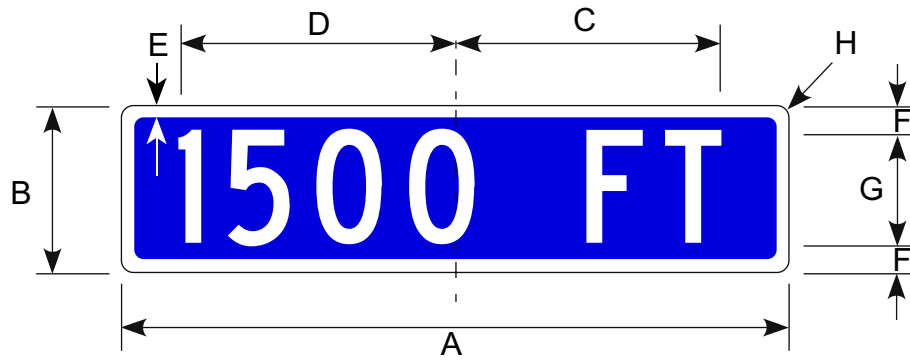

Border and Legend: White
 Background: Blue or Brown

Prior to the 2002 publication of this manual,
 this sign was numbered D9-E.

Road Class	Dimensions (inches)							
	A	B	C	D	E	F	G	H
Conv & Min	24	6	9.50	9.88	0.5	1	4C	1.5

DESTINATION SIGNS - MILE POSTS

D10-1 to D10-104A

Message on one side of sign

D10-1
D10-2
D10-3
D10-400

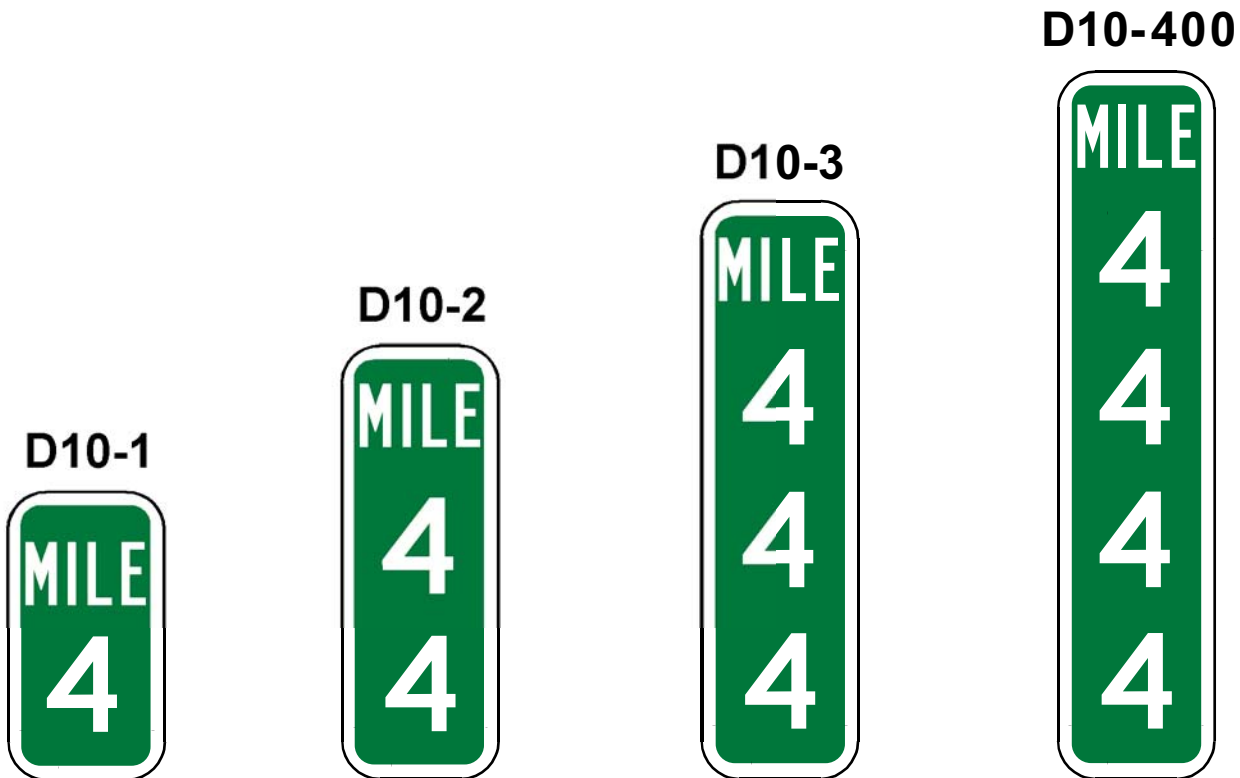

Border and Legend: White
Background: Green

Sign Number	Sign Size	Dimensions (inches)			
		Letter Size and Series	Num. Size and Series	Border Width	Corner Radius
D10-1	10 x 18	4B	6D	0.50	1.00
	12 x 24	4C	10D	0.75	1.50
D10-2	10 x 27	4B	6D	0.50	1.00
	12 x 36	4C	10D	0.75	1.50
D10-3	10 x 36	4B	6D	0.50	1.00
	12 x 48	4C	10D	0.75	1.50
D10-400	10 x 42	4B	6D	0.50	1.00
	12 x 66	4C	10D	0.75	1.50

D10-1A
D10-2A
D10-3A

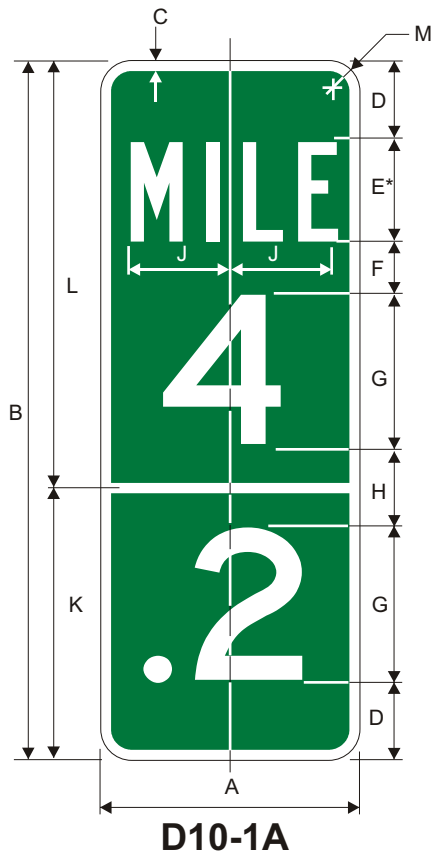

D10-1A

Road Class	Dimensions (inches)					
	A	B	C	D	E	F
Mn/Conv	10	27	0.5	3.0	4B	2.0
Expy/Fwy	12	36	0.5	3.0	4B	3.0
	G	H	J	K	L	M
6D	3.0	3.92	10.5	16.5	1.5	
10D	3.0	3.92	14.5	21.5	1.5	

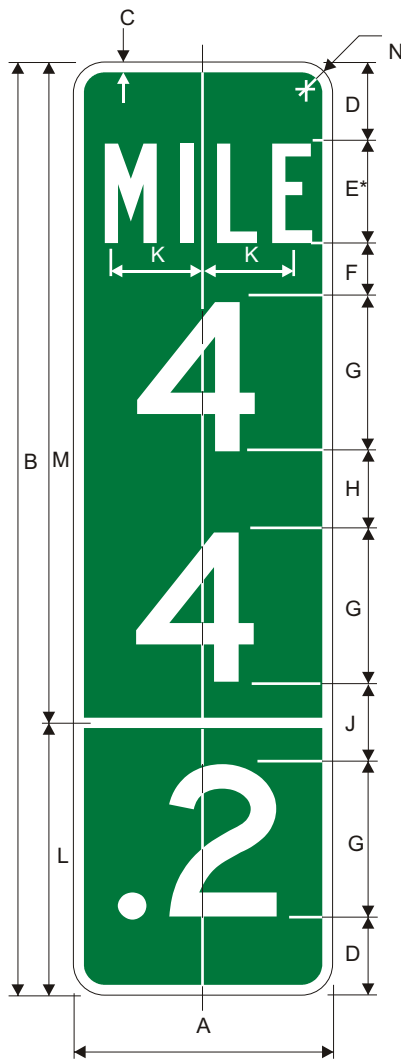

D10-2A

Road Class	Dimensions (inches)						
	A	B	C	D	E	F	
Mn/Conv	10	36	0.5	3.0	4B	2.0	
Expy/Fwy	12	48	0.5	2.0	4B	3.0	
	G	H	J	K	L	M	N
6D	3.0	3.0	3.92	10.5	25.5	1.5	
10D	3.0	4.0	3.92	14.0	34	1.5	

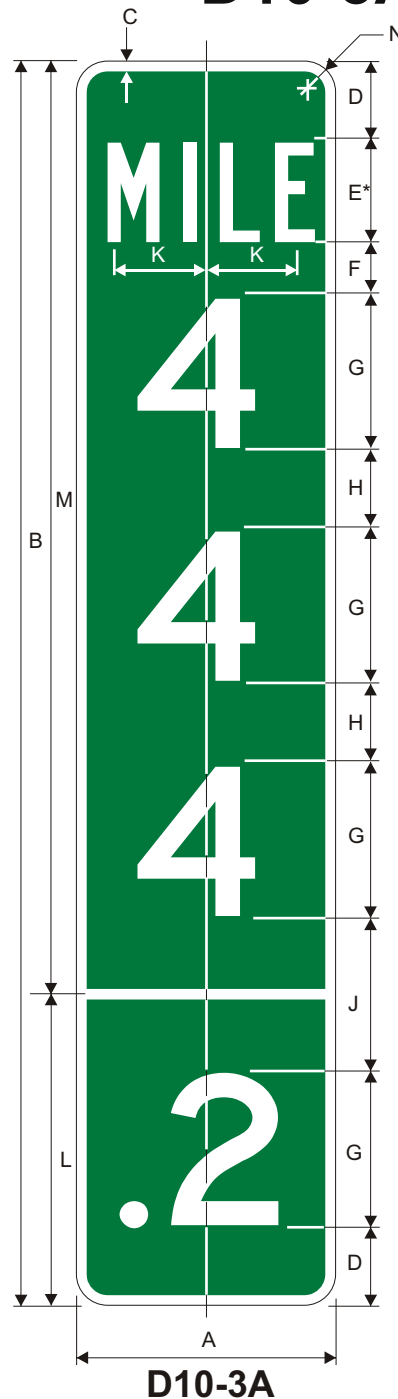

D10-3A

Road Class	Dimensions (inches)						
	A	B	C	D	E	F	
Mn/Conv	10	48	0.5	3.0	4B	2.0	
Expy/Fwy	12	60	0.5	2.0	4B	3.0	
	G	H	J	K	L	M	N
6D	3.0	6.0	3.92	12	36	1.5	
10D	2.0	5.0	3.92	14.5	45.5	1.5	

Optically locate numerals about centerline.

Border and Legend: White
 Background: Green

D10-101
 D10-102
 D10-103
 D10-104

Message on both
 sides of sign

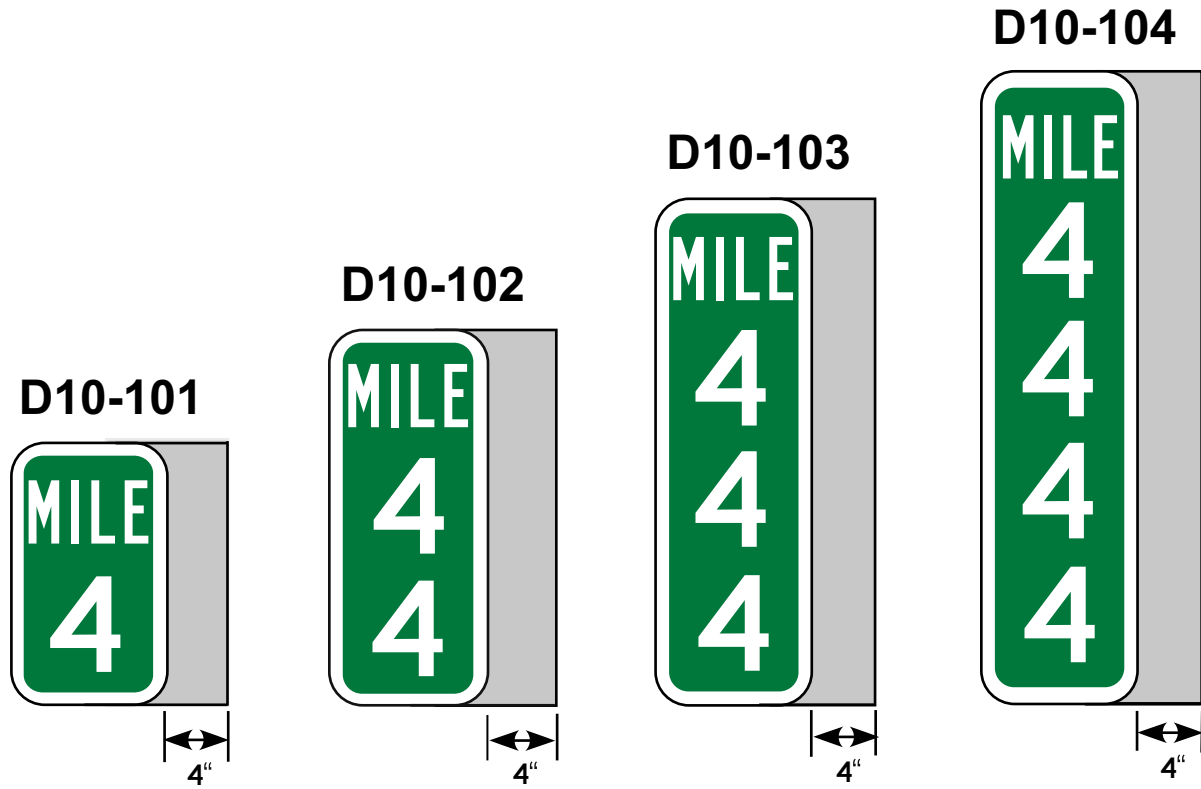

Note: 4" mounting area may be bare aluminum or green reflective material.

Border and Legend: White
 Background: Green

Sign Number	Sign Size	Dimensions (inches)			
		Letter Size and Series	Num. Size and Series	Border Width	Corner Radius
D10-101	14 x 18	4B	6D	0.5	1
	16 x 24	4C	10D	0.75	1.5
D10-102	14 x 27	4B	6D	0.5	1
	16 x 36	4C	10D	0.75	1.5
D10-103	14 x 36	4B	6D	0.5	1
	16 x 48	4C	10D	0.75	1.5
D10-104	14 x 42	4B	6D	0.5	1
	16 x 66	4C	10D	0.75	1.5

D10-101A
 D10-102A
 D10-103A
 D10-104A

Message on both
 sides of sign

D10-101



D10-102



D10-103



D10-104



Note: 4" mounting area may be bare aluminum or green reflective material.

Border and Legend: White
 Background: Green

Dimensions (inches)

Sign Number	Sign Size	Letter Size and Series	Num. Size and Series	Border Width	Corner Radius
D10-101	14 x 18	4B	6D	0.5	1
	16 x 24	4C	10D	0.75	1.5
D10-102	14 x 27	4B	6D	0.5	1
	16 x 36	4C	10D	0.75	1.5
D10-103	14 x 36	4B	6D	0.5	1
	16 x 48	4C	10D	0.75	1.5
D10-104	14 x 42	4B	6D	0.5	1
	16 x 66	4C	10D	0.75	1.5

DESTINATION SIGNS - BIKE ROUTE, WEATHER, CAR POOL INFO

D11-1 to D11-102



*Make symbol proportional to graphic shown.

Border and Legend: White
Background: Green

Road Class	Dimensions (inches)									
	A	B	C	D	E	F	G	H	J	K
Minimum	24	18	0.50	1.50	7.00	3.50	3C	5.50	1.50	1.50
Conventional	30	24	0.63	1.88	8.75	4.38	4C	6.88	3.11	1.75

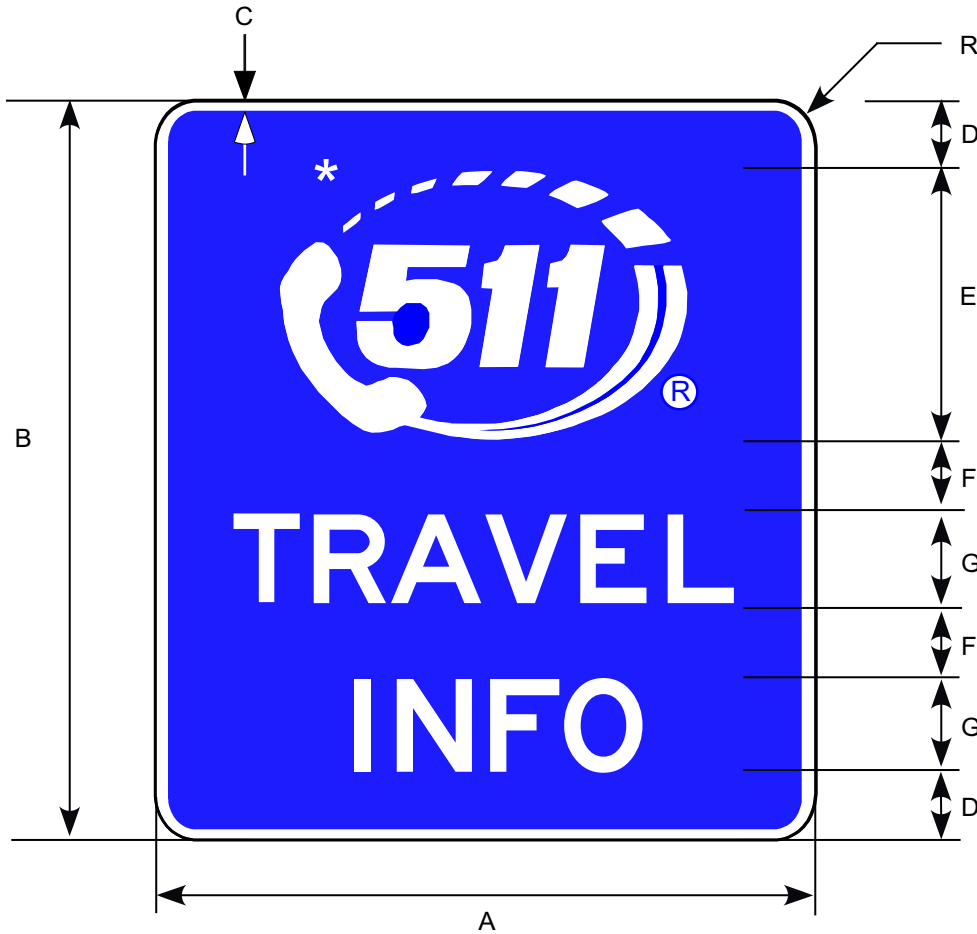

Border, Symbol and Legend: White
Background: Blue

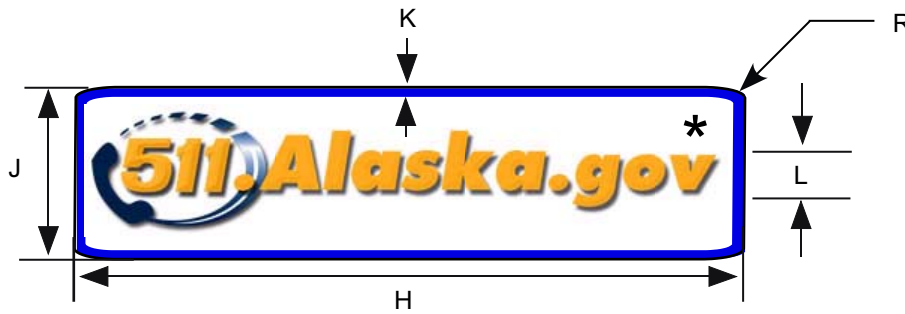

Only use plate with above sign off roads, for example at Ferry & Airport Terminals and Road Side Rest Areas.

* Make symbol and lettering proportional to graphic shown.

Border and Symbol: Blue
Legend: Orange
Background: White

Road Class	Dimensions (inches)											
	A	B	C	D	E	F	G	H	J	K	L	R
Off Roads (Terminals)	24	30	0.38	3.0	10	3.0	4D	30	6.0	0.38	2.0	1.5
Conventional	36	48	0.63	5.0	16	5.0	6D	N/A	N/A	N/A	N/A	2.25
Expressway	48	60	0.75	7.0	18	6.0	8D	N/A	N/A	N/A	N/A	3.0

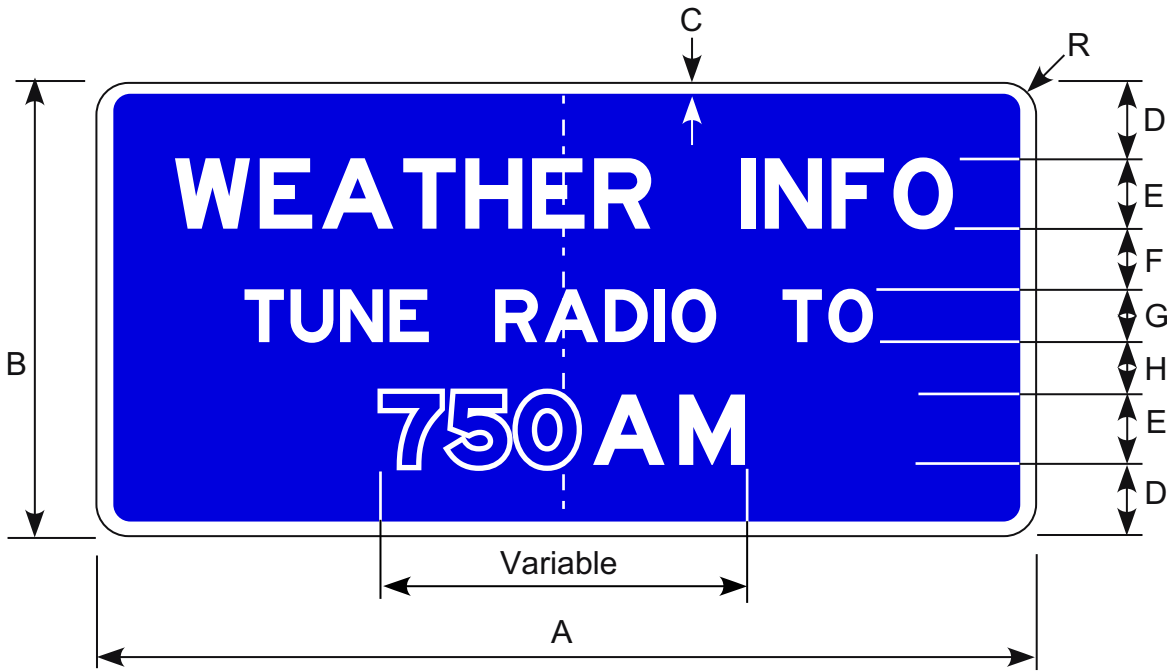

Border and Legend: White
Background: Blue

Note: Radio frequency as noted on the plans.

Prior to the 2002 publication of this manual,
this sign was numbered D12-1.

Road Class	Dimensions (inches)									
	A	B	C	D	E	F	G	H	R	
Minimum	84	42	1.5	8.5	6E	5	4E	4	2.60	
Conventional	108	54	2.0	9.5	8E	7	6E	6	3.38	
Expwy/Fwy	132	72	2.0	13.5	10E	9	8E	8	4.50	

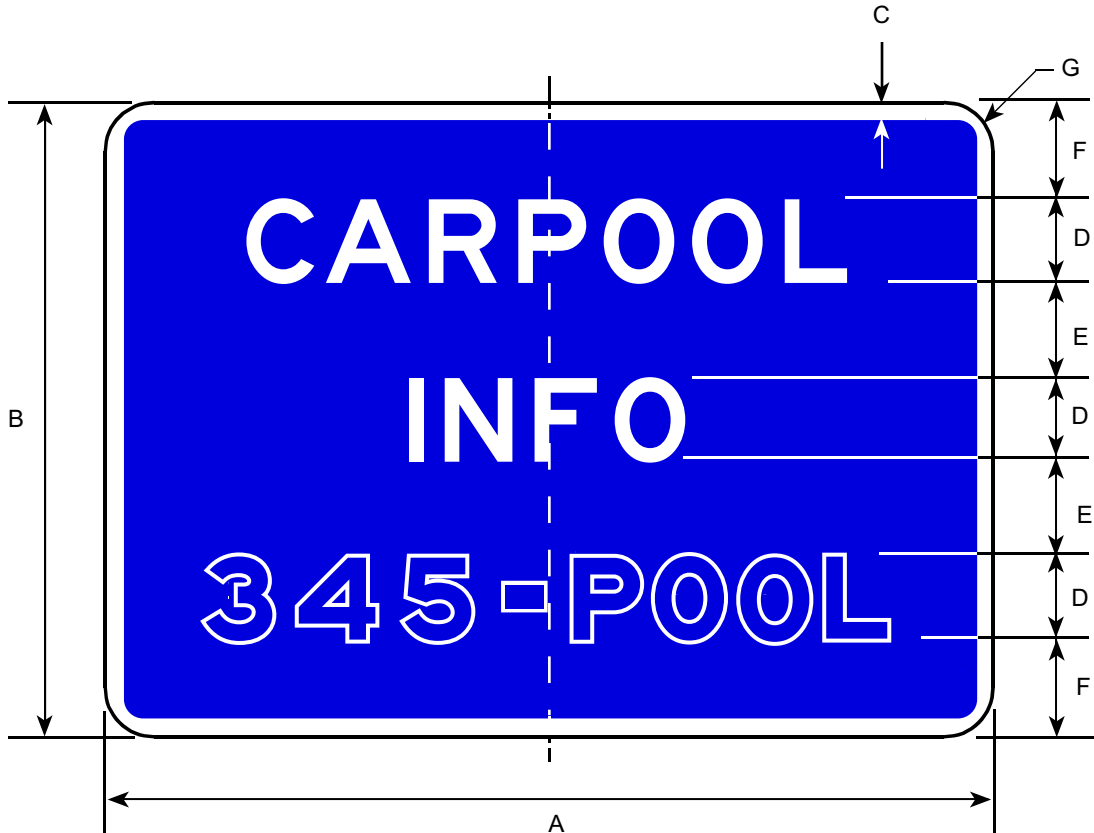

Note: Telephone number as noted on the plans.

Border and Legend: White Background: Blue

Prior to the 2002 publication of this manual, this sign was numbered D12-2.

Road Class	Dimensions (inches)						
	A	B	C	D	E	F	G
Minimum	48	30	0.75	4E	4.25	4.75	2.25
Conventional	60	48	1.0	6E	6.0	9.0	3.0
Expressway	72	54	1.5	8E	7.0	8.0	4.0

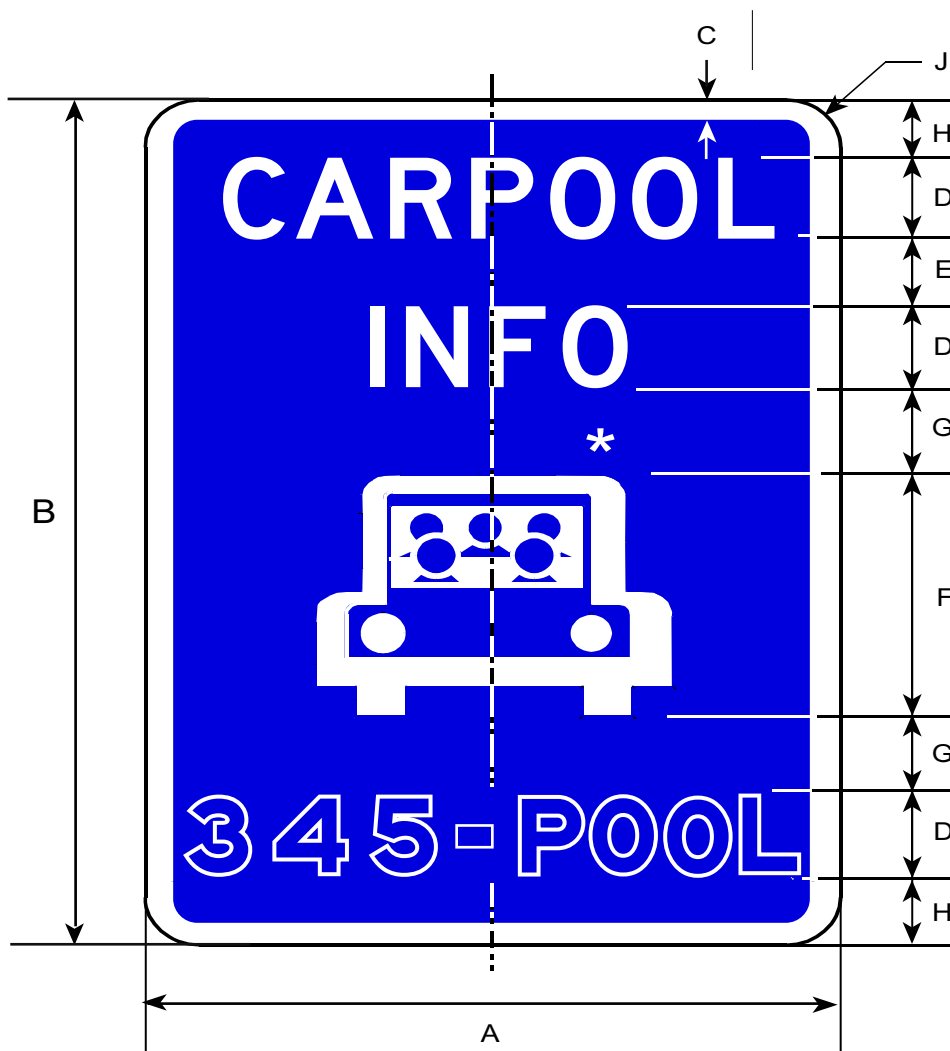

*Make symbol proportional to graphic shown.

Border and Legend: White
Background: Blue

Note: Telephone number as noted on the plans.

Road Class	Dimensions (inches)								
	A	B	C	D	E	F	G	H	J
Conv & Min	30	48	0.75	4D	3	12	4	6.5	4.5

DESTINATION SIGNS - FREEWAY ENTRANCE

D13-3 to D13-3A

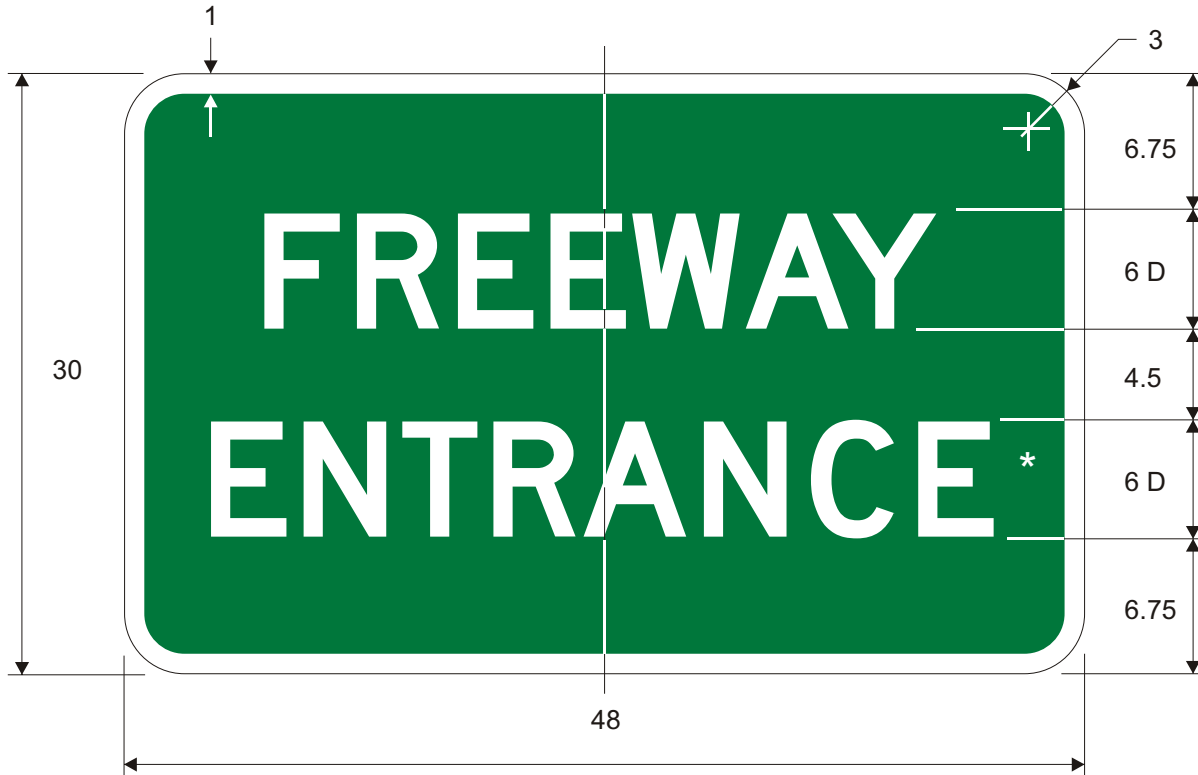

*Reduce spacing to fit.

Border and Legend: White
Background: Green

D13-3A

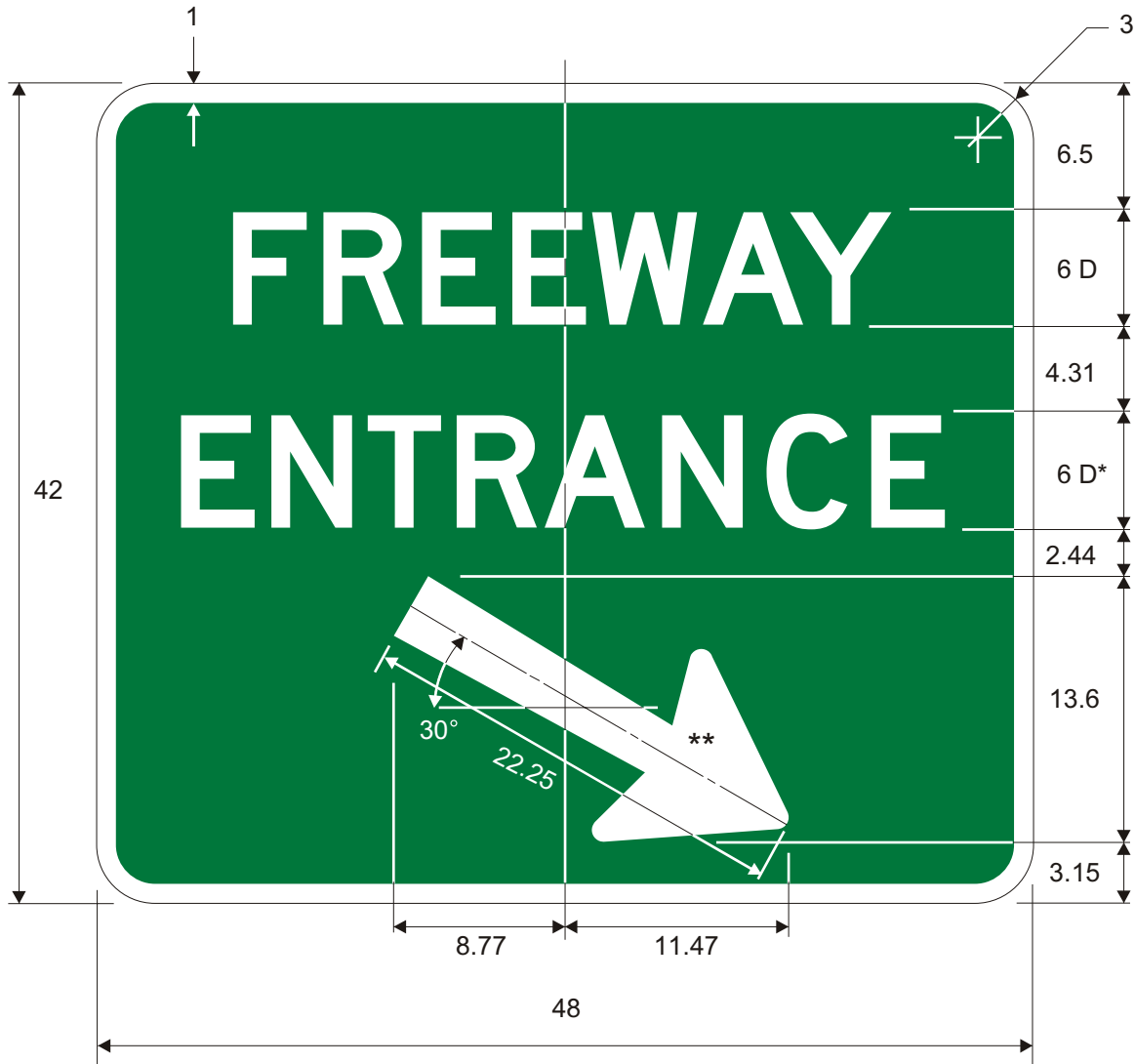

D13-3AL

D13-3AR

*Reduce spacing to fit.

**See Appendix B-4 for Arrow Details.

Border and Legend: White
Background: Green

DESTINATION SIGNS - EXPWYS & FWYS

E1-5 to E11-1

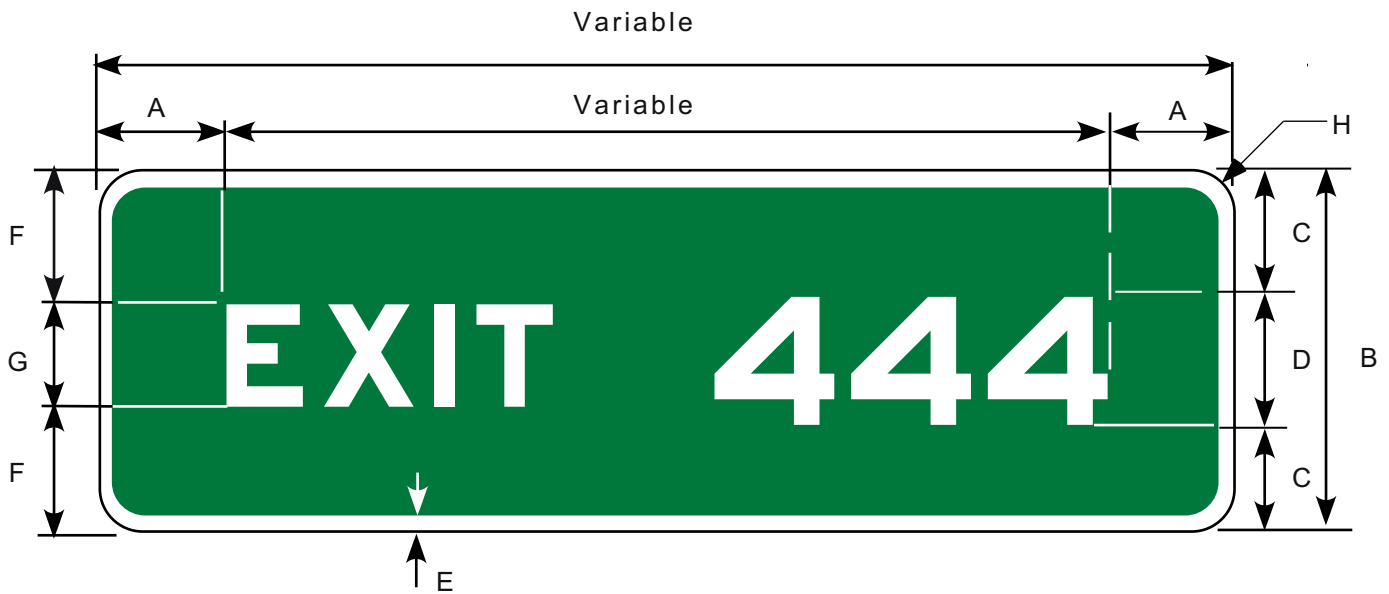

Border and Legend: White
 Background: Green

Letter Size (inches)	Dimensions (inches)							
	A	B	C	D	E	F	G	H
16 / 12	12±	42	13	16	2	15	12	2.25

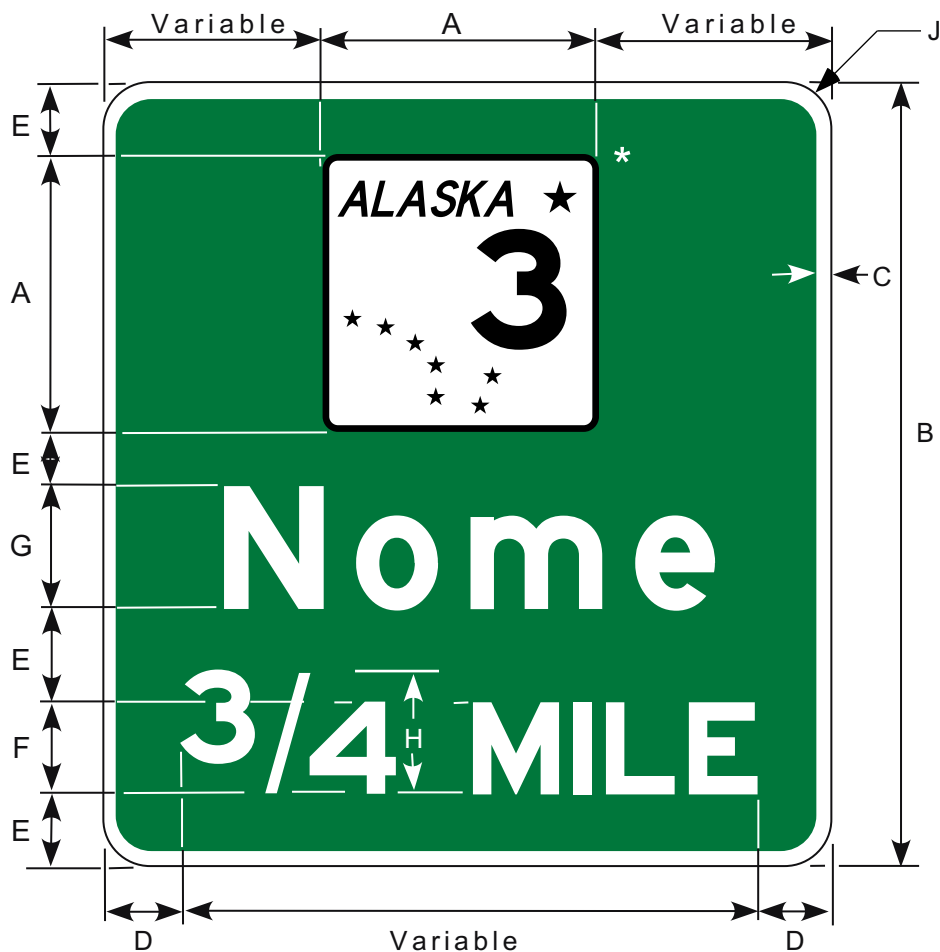

Border and Legend: White
 Background: Green
 Marker: Black on White

*Make symbol proportional to graphic shown

Letter Size (inches)	Dimensions (inches)								
	A	B	C	D	E	F	G	H	J
16 / 12	36	110	2	10±	12	10	16/12	15	4

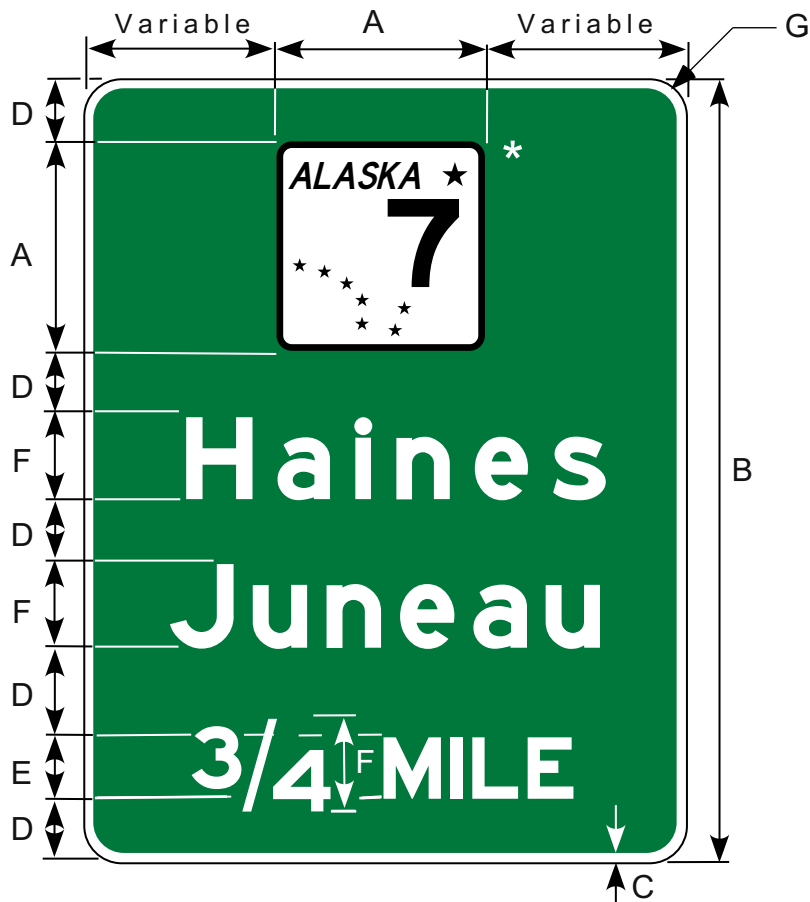

Border and Legend: White
 Background: Green
 Marker: Black on White

* Make symbol proportional to graphic shown

Letter Size (inches)	Dimensions (inches)						
	A	B	C	D	E	F	G
16 / 12	36	138	2	12	10	16/12	4

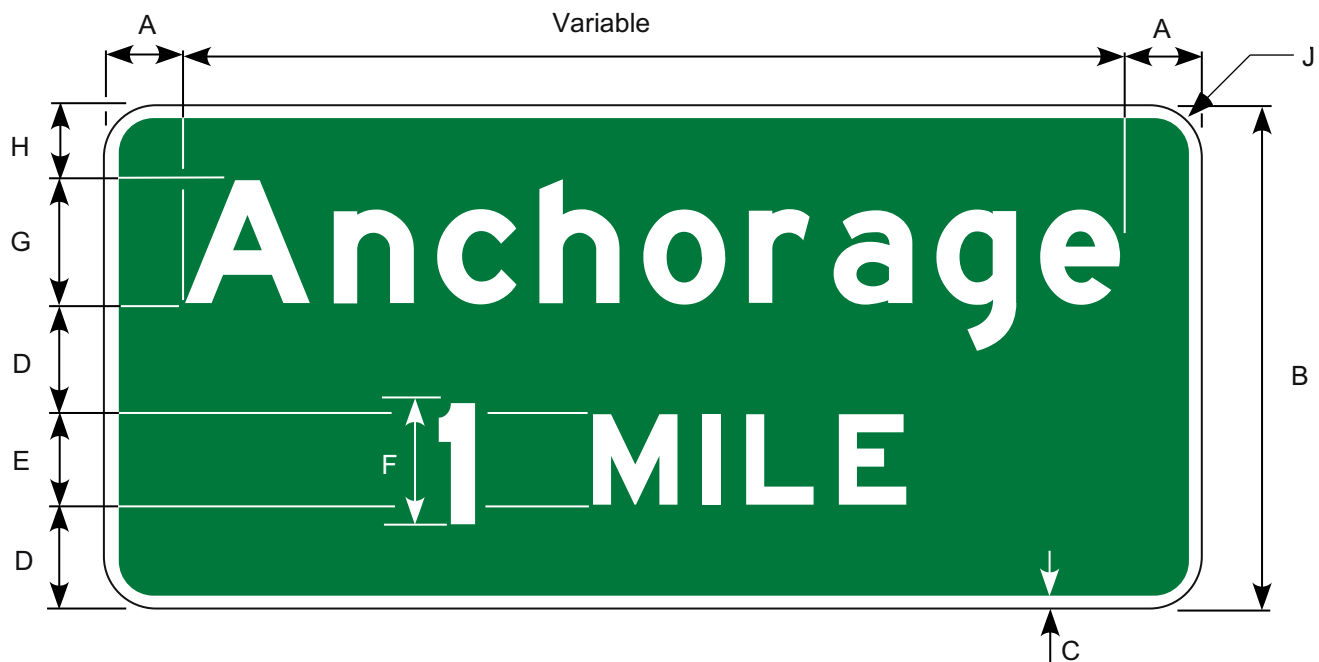

Border and Legend: White
 Background: Green

Letter Size (inches)	Dimensions (inches)								
	A	B	C	D	E	F	G	H	J
16 / 12	16±	60	2	12	10	16	16/12	10	3.75

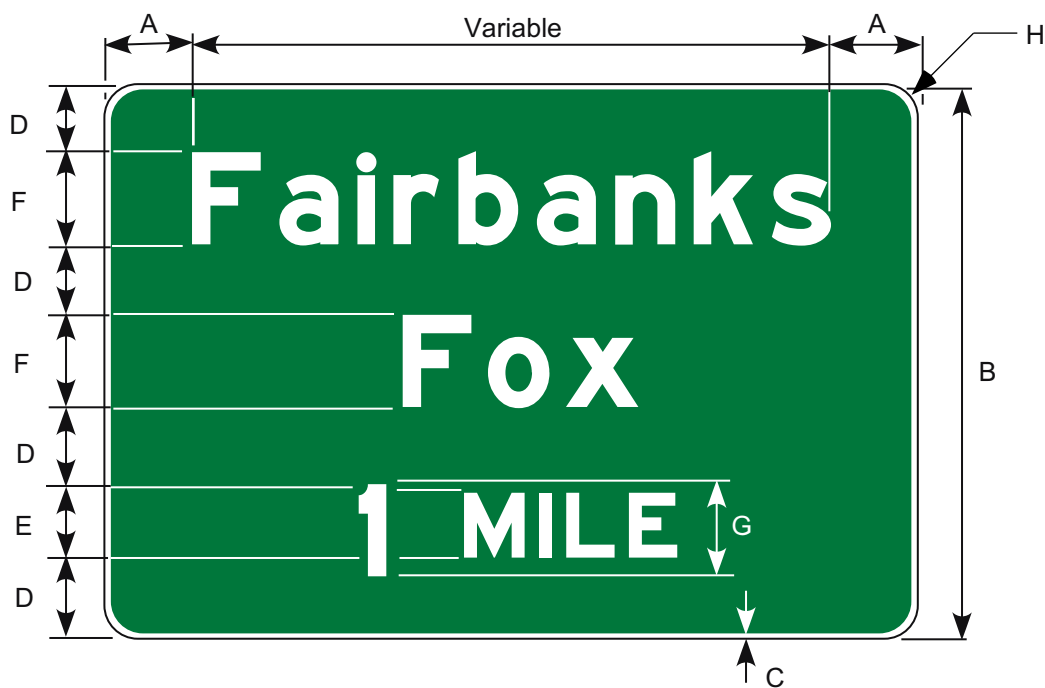

Border and Legend: White
 Background: Green

Letter Size (inches)	Dimensions (inches)							
	A	B	C	D	E	F	G	H
16 / 12	16±	90	2	12	10	16/12	15	4

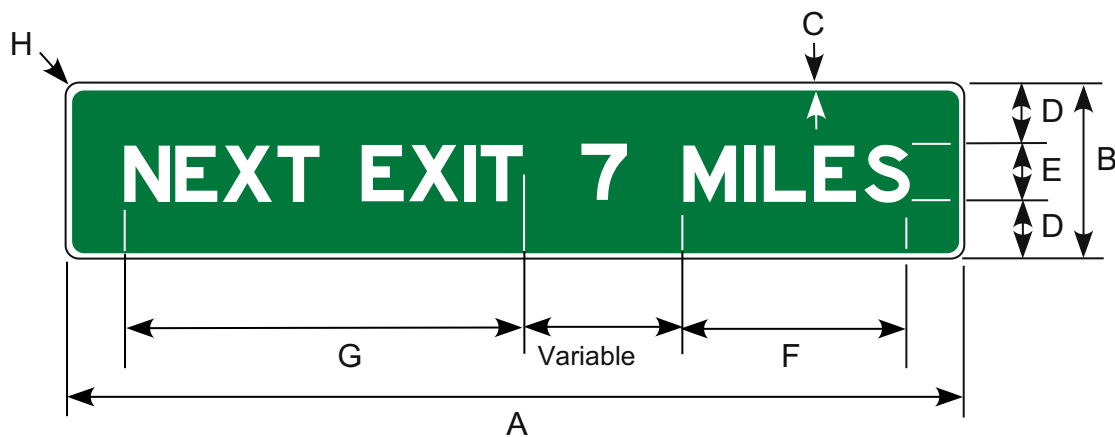

Border and Legend: White
 Background: Green

Letter Size (inches)	Dimensions (inches)							
	A	B	C	D	E	F	G	H
10	156	30	0.75	10	10	38.25	69.81	1.88

E2-1A

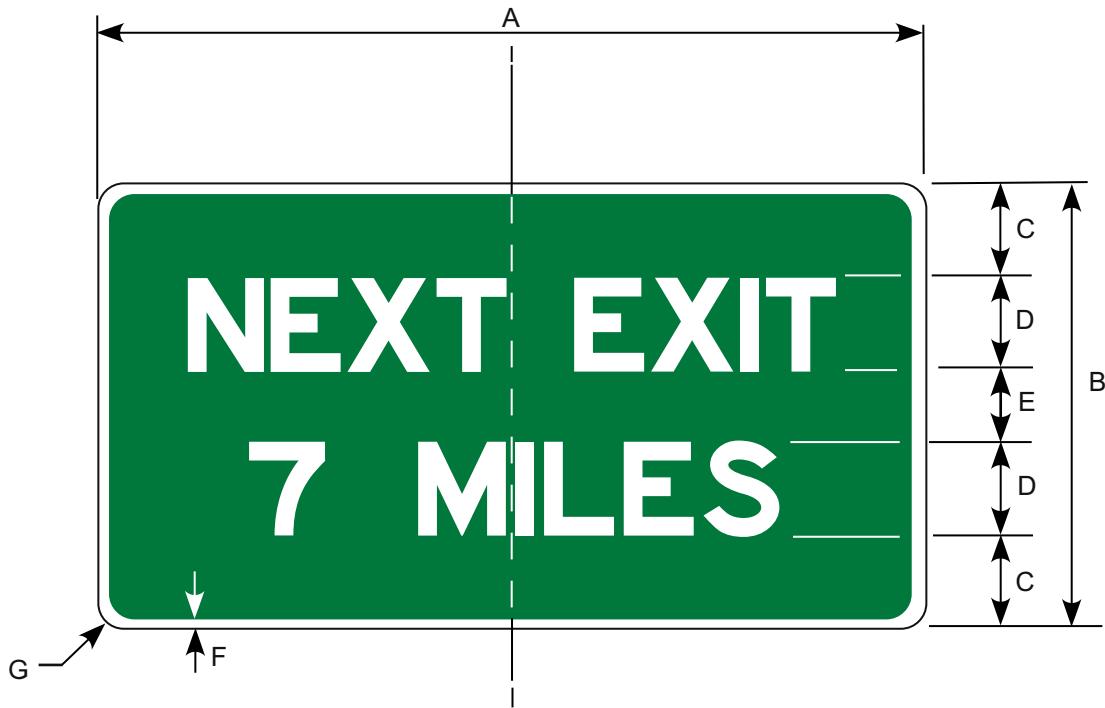

Border and Legend: White
Background: Green

Letter Size (inches)	Dimensions (inches)						
	A	B	C	D	E	F	G
10	90	48	10	10	8	1.25	3



Border and Legend: White
 Background: Green

Letter Size (inches)	Dimensions (inches)							
	A	B	C	D	E	F	G	H
16 / 12	12±	66	2.0	12	12	14	16/12	4.0

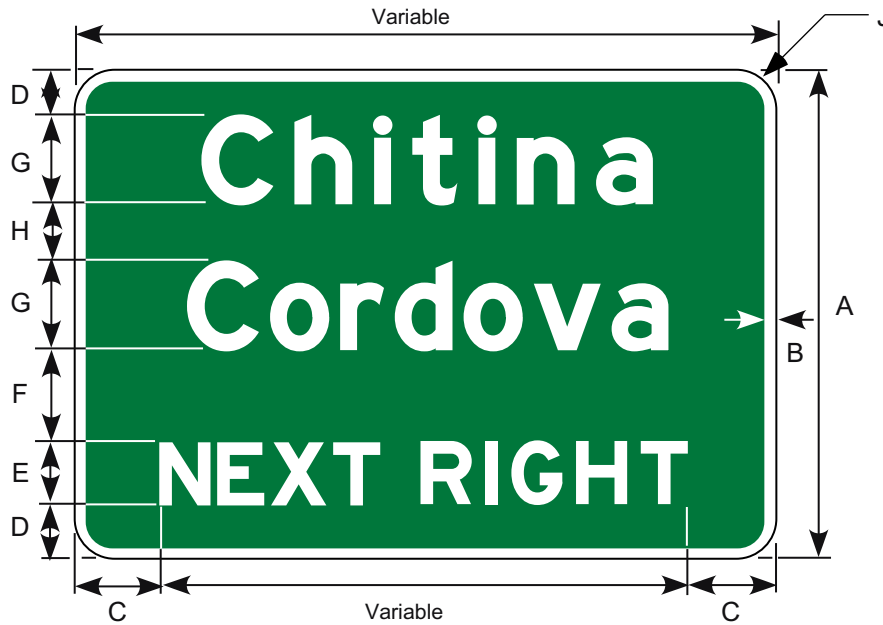

Border and Legend: White
 Background: Green

Letter Size (inches)	Dimensions (inches)								
	A	B	C	D	E	F	G	H	J
16 / 12	90	2.0	12±	10	12	14	16/12	12	4.0

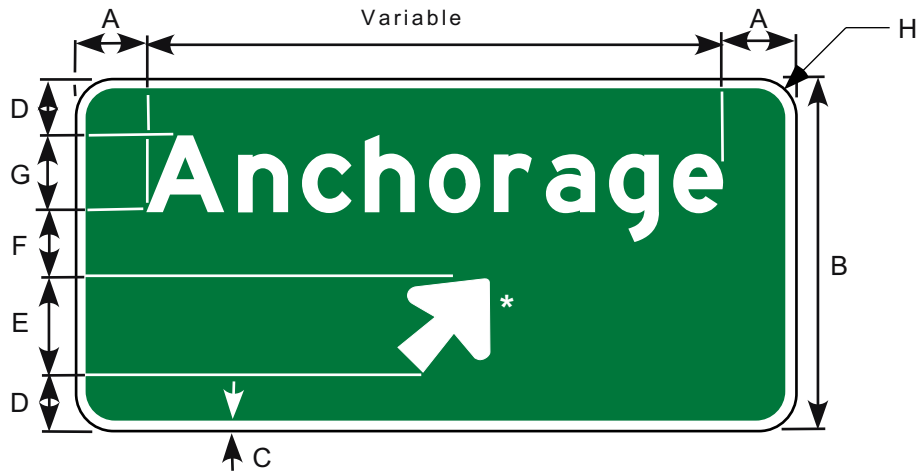

Border and Legend: White
Background: Green

* See Appendix B-4 for Arrow Details.

Letter Size (inches)	Dimensions (inches)							
	A	B	C	D	E	F	G	H
16 / 12	16±	72	2.0	10	24	12	16/12	4.0

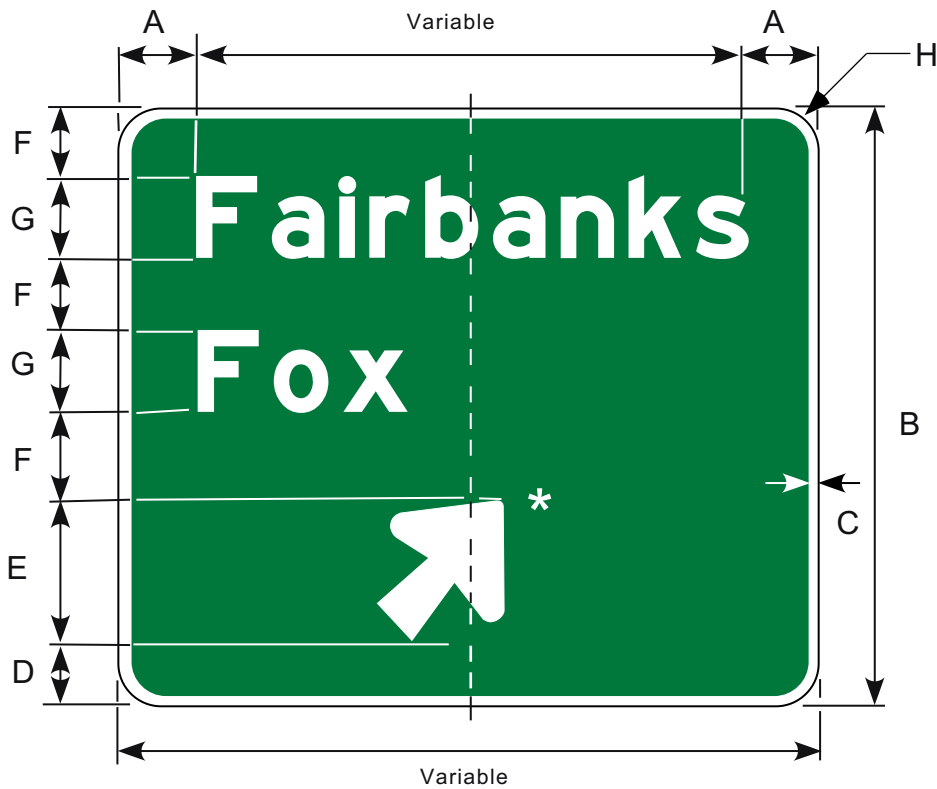

Border and Legend: White
Background: Green

* See Appendix B-4 for Arrow Details.

Letter Size (inches)	Dimensions (inches)							
	A	B	C	D	E	F	G	H
16 / 12	16±	102	2.0	10	24	12	16/12	4.0

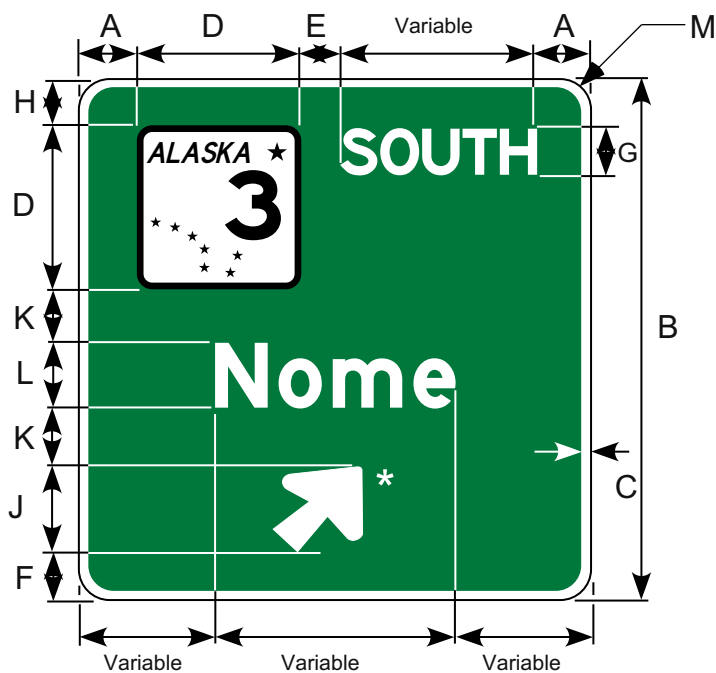

Border and Legend: White
 Background: Green
 Marker: Black on White

* See Appendix B-4 for Arrow Details.

Make symbol proportional to graphic shown

Letter Size (inches)	Dimensions (inches)											
	A	B	C	D	E	F	G	H	J	K	L	M
16 / 12	10±	120	2.0	36	3.0	10	12D	10	24	12	16/12	4.0

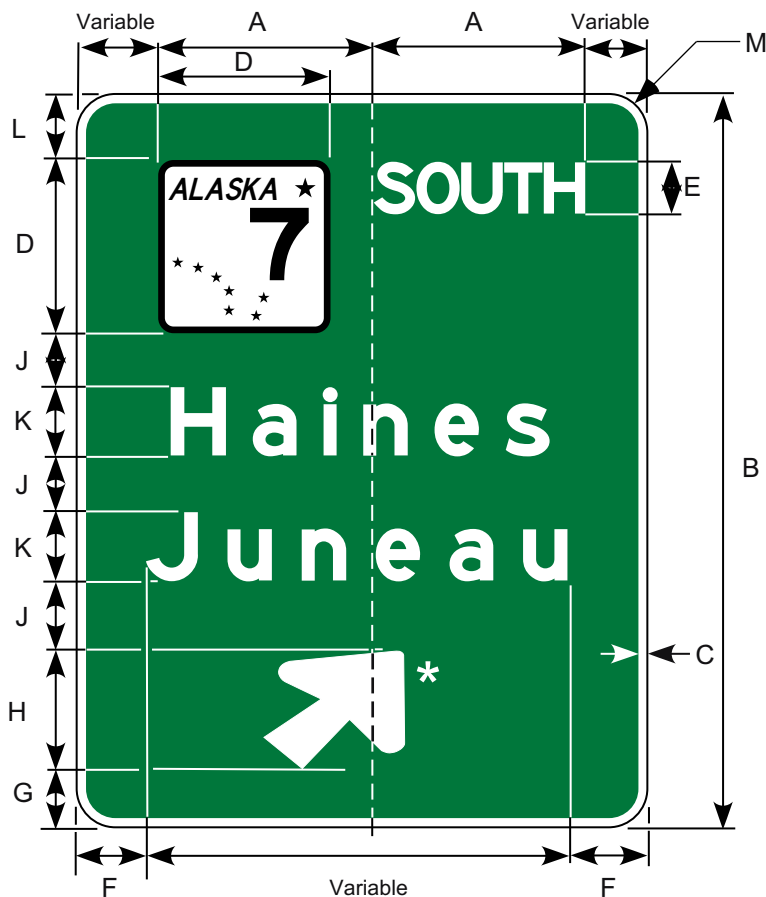

Border and Legend: White
 Background: Green
 Marker: Black on White

* See Appendix B-4 for
 Standard Arrow Details.

Make symbol proportional to graphic shown

Letter Size (inches)	Dimensions (inches)											
	A	B	C	D	E	F	G	H	J	K	L	M
16 / 12	50	150	2.0	36	12D	16	10	24	12	16/12	12	4.0

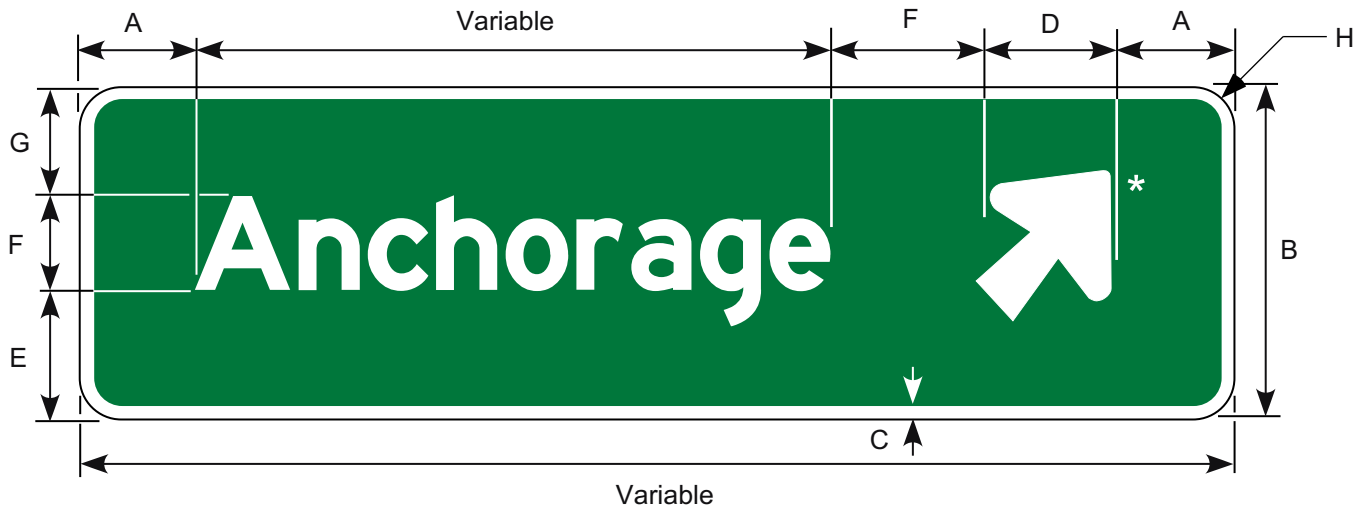

Border and Legend: White
Background: Green

* See Appendix B-4 for Arrow Details.

Letter Size (inches)	Dimensions (inches)							
	A	B	C	D	E	F	G	H
16 / 12	16	42	2.0	20.25	14	16/12	12	2.63



Border and Legend: White
Background: Green

* See Appendix B-4 for Arrow Details.

Letter Size (inches)	Dimensions (inches)							
	A	B	C	D	E	F	G	H
16 / 12	16	72	2.0	23.63	14	16/12	12	4.0

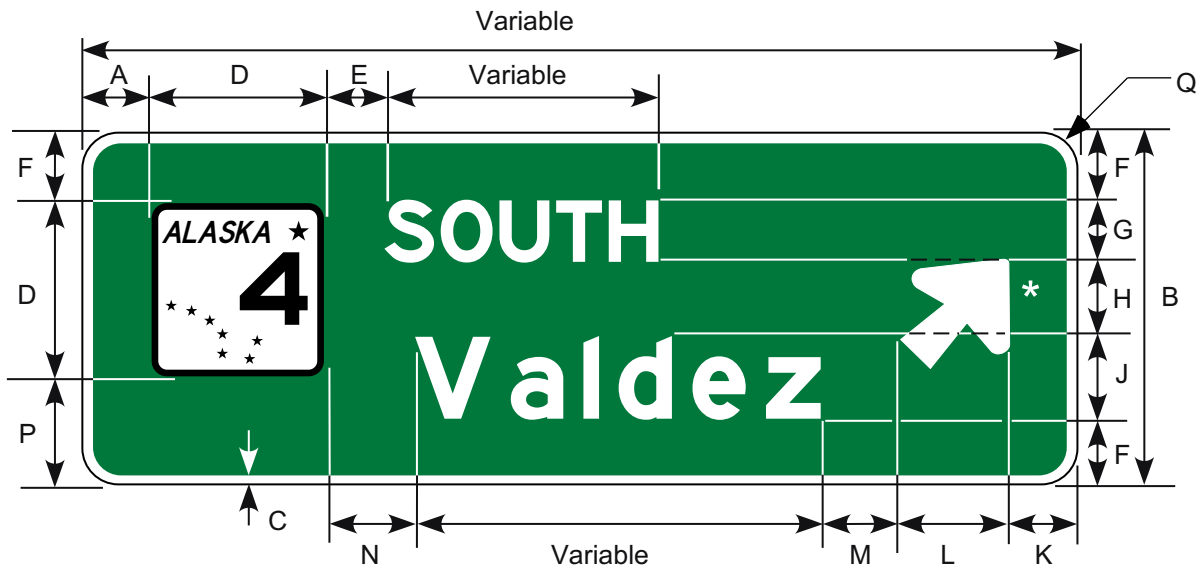

Border and Legend: White
 Background: Green
 Marker: Black on White

* See Appendix B-4 for Arrow Details.

Make symbol proportional to graphic shown

Letter Size (inches)	Dimensions (inches)														
	A	B	C	D	E	F	G	H	J	K	L	M	N	P	Q
16 / 12	14	72	2.0	36	12	14	12	16	16/12	14±	23.63	16±	18	22	4.0

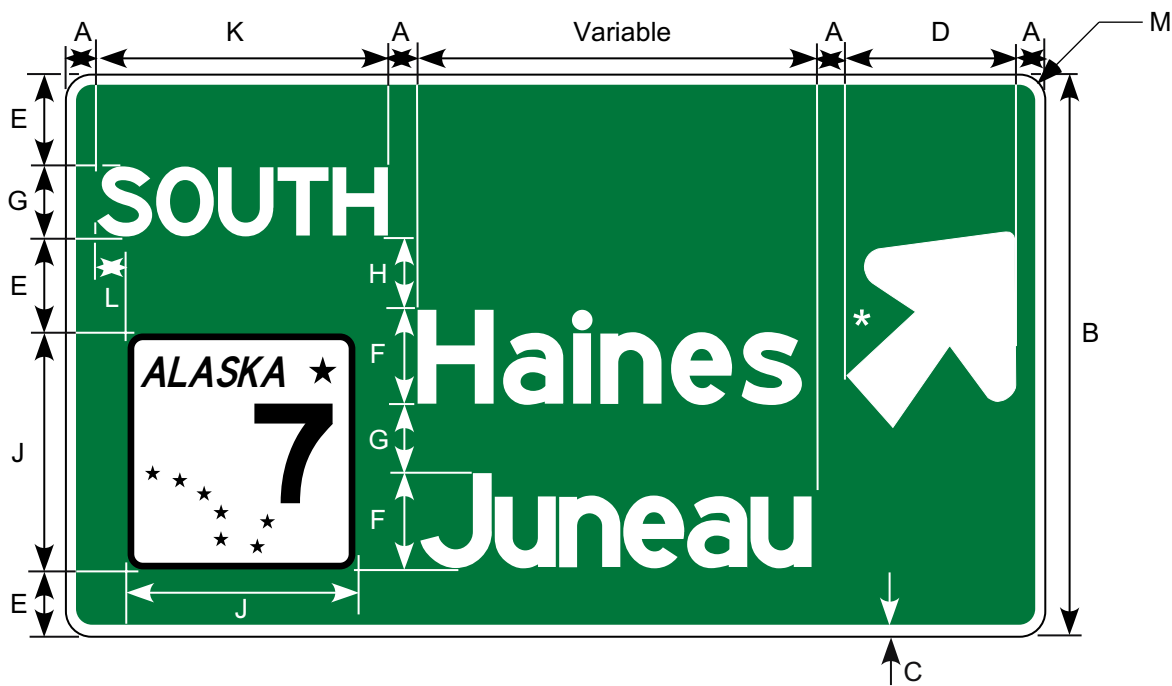

Border and Legend: White
 Background: Green
 Marker: Black on White

* See Appendix B-4 for Arrow Details.

Make symbol proportional to graphic shown

Letter Size (inches)	Dimensions (inches)											
	A	B	C	D	E	F	G	H	J	K	L	M
16 / 12	16	90	2.0	23.63	14	16/12	12	6.0	36	VAR	(K-36)/2	4.0

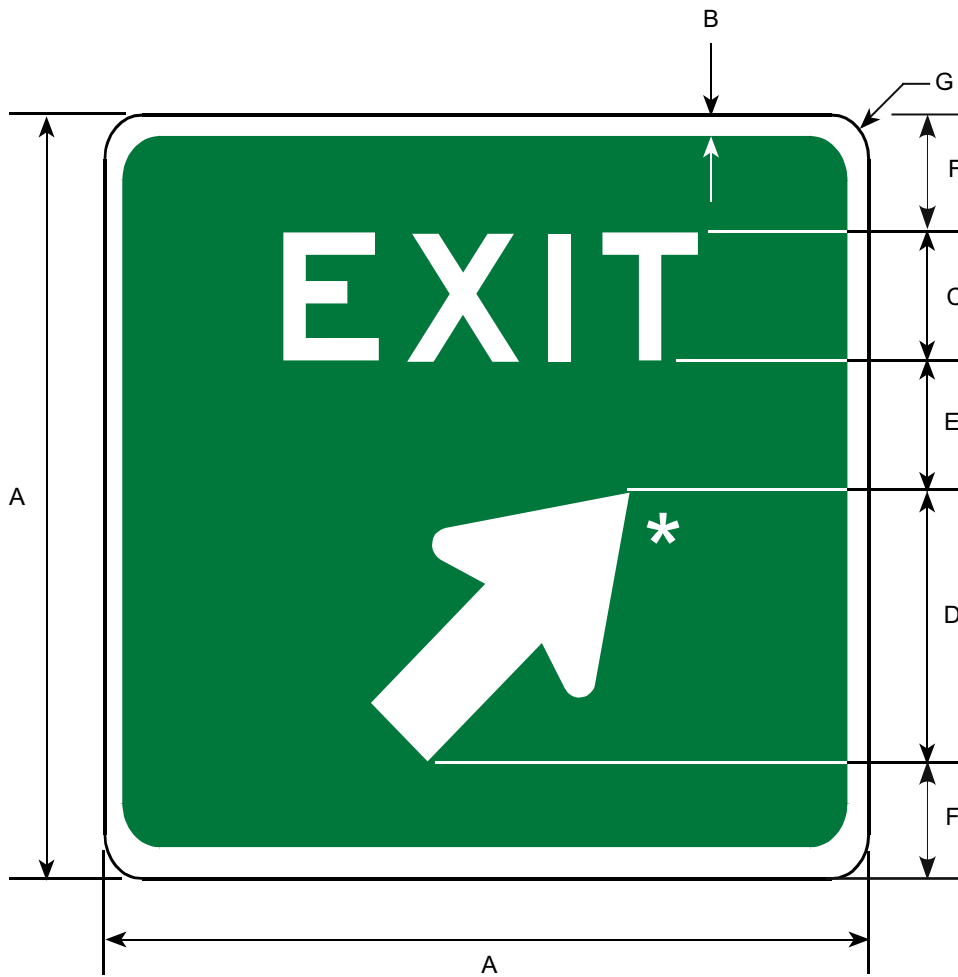

Border and Legend: White
Background: Green

* See Appendix B-4 for Arrow Details.

Road Class	Dimensions (inches)						
	A	B	C	D	E	F	G
Minimum	48	1.5	8.0	16.38	8.0	7.81	3.0
Conventional	60	2.0	10	23.62	10	8.19	3.75

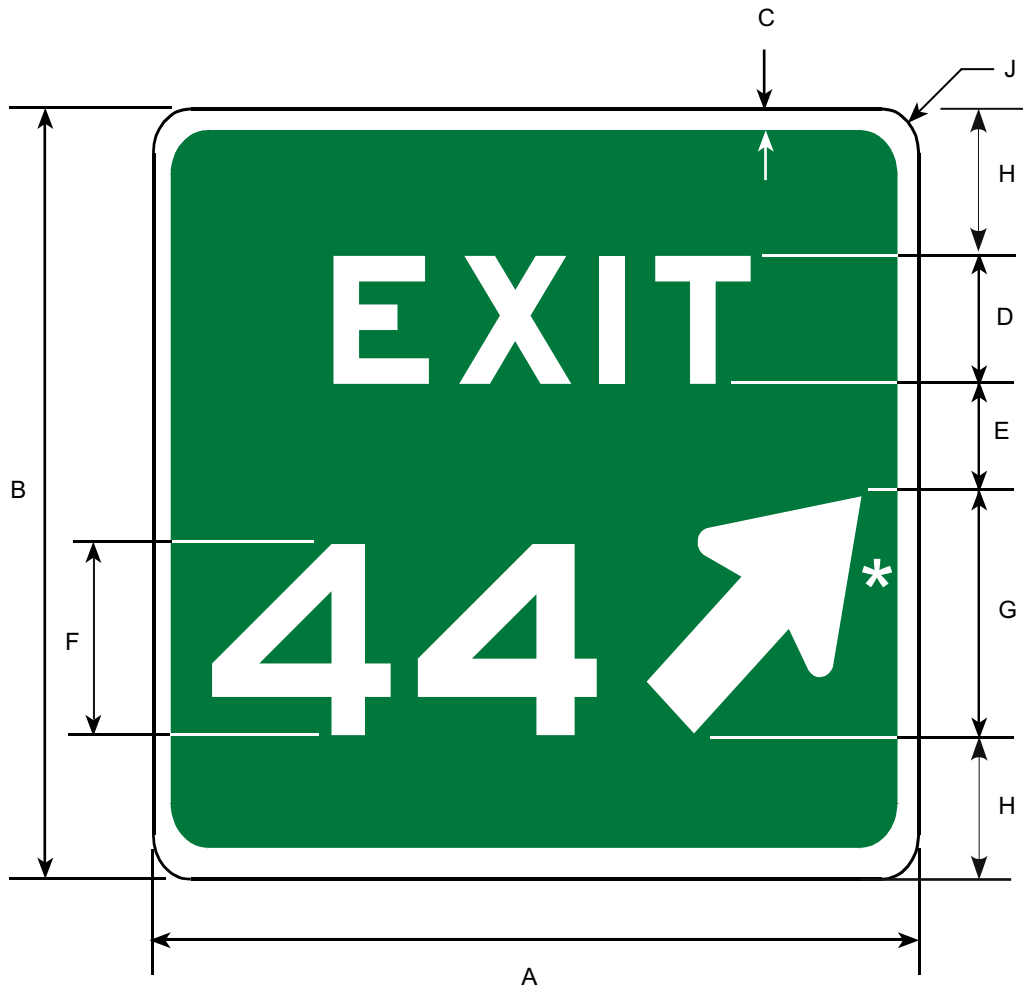

Border and Legend: White
Background: Green

* See Appendix B-4 for Arrow Details.

Road Class	Dimensions (inches)								
	A	B	C	D	E	F	G	H	J
Minimum	VAR	48	1.5	8E	8.0	12	16.38	7.81	3.0
Conventional	VAR	60	2.0	10E	10	15	23.62	8.19	3.75

E5-2
E5-2A
E5-3

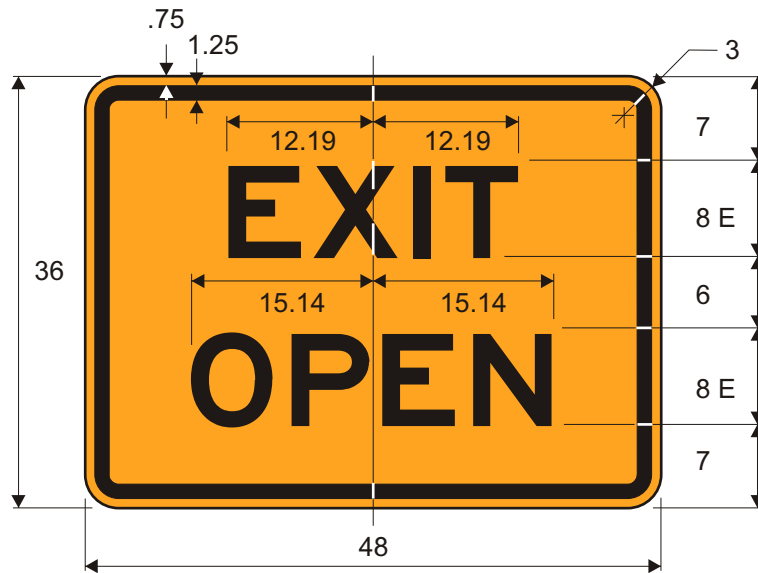

E5-2

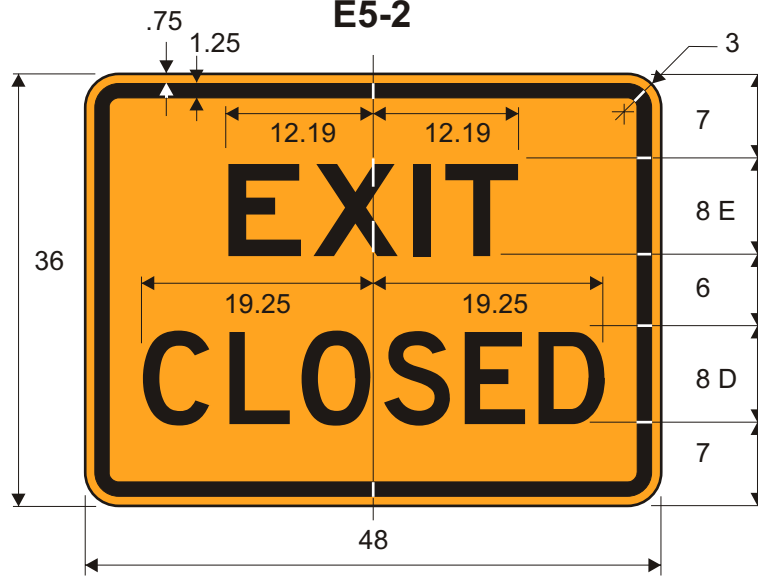

E5-2a



E5-3

Border and Legend: Black
 Background: Orange

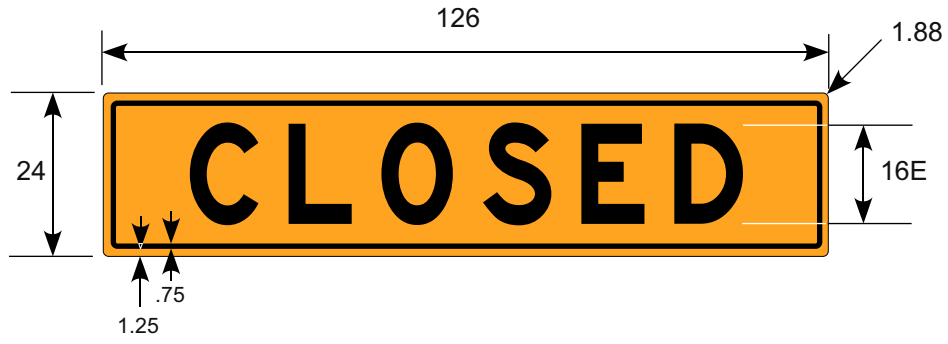

Border and Legend: Black
Background: Orange

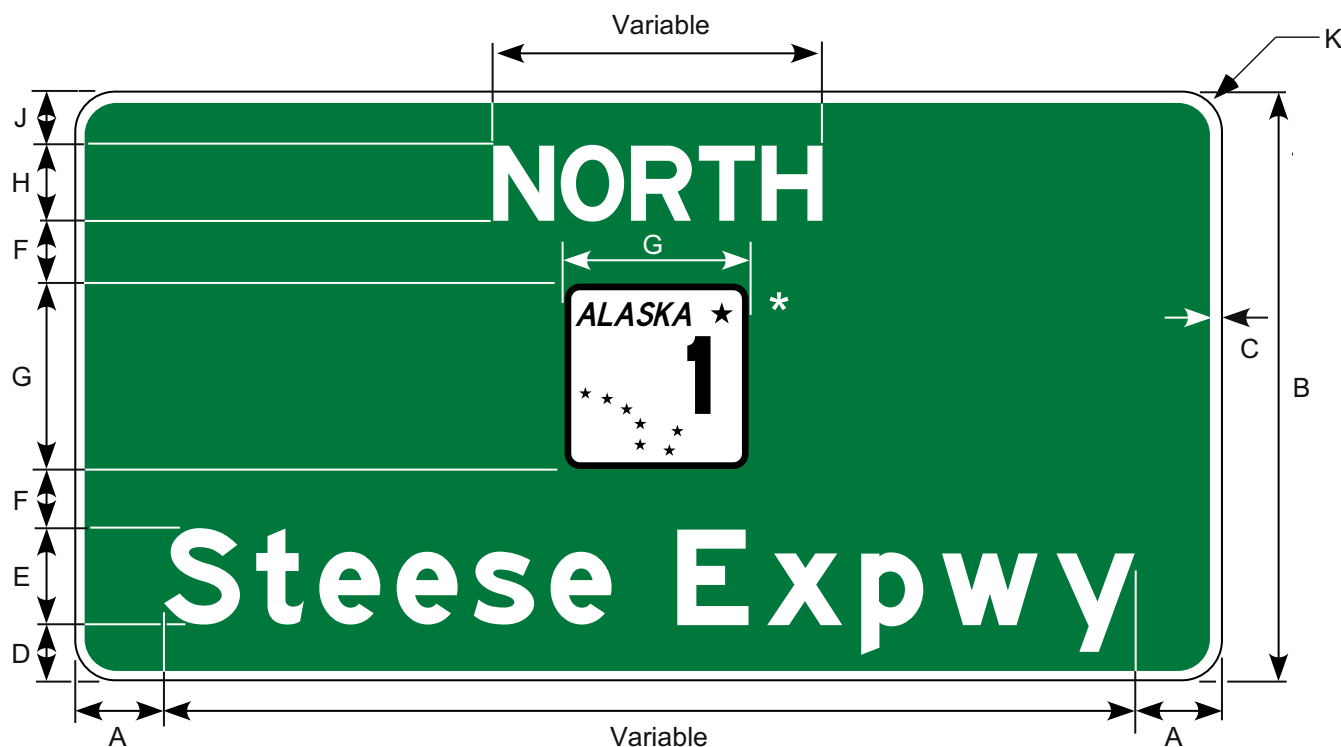

Border and Legend: White
 Background: Green
 Marker: Black on White

* Make symbol proportional to graphic shown

Letter Size (inches)	Dimensions (inches)									
	A	B	C	D	E	F	G	H	J	K
16 / 12	16±	108	2	10	16/12	12	36	12	10	4

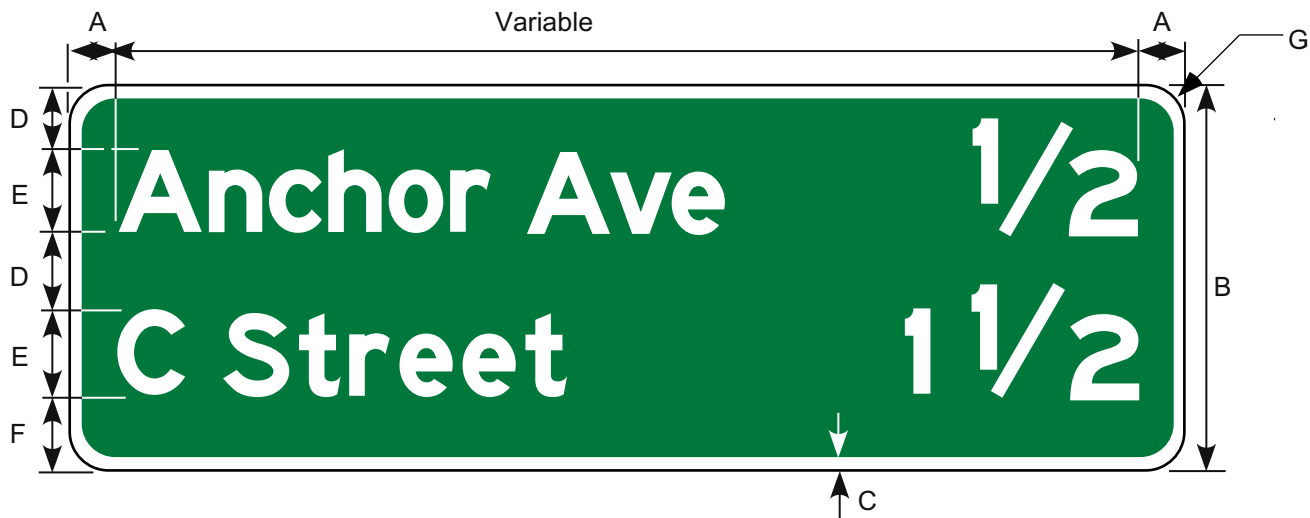

Border and Legend: White
 Background: Green

Letter Size (inches)	Dimensions (inches)						
	A	B	C	D	E	F	G
16 / 12	16±	66	0.50	12	16/12	10	4.0



Border and Legend: White
 Background: Green

Letter Size (inches)	Dimensions (inches)					
	A	B	C	D	E	F
16 / 12	16±	96	2	12	16/12	4



Border and Legend: White
 Background: Green

Letter Size (inches)	Dimensions (inches)								
	A	B	C	D	E	F	G	H	J
16 / 12	16±	60	2.0	16	11	10	16/12	12	3.75



Border and Legend: White
 Background: Green

Letter Size (inches)	Dimensions (inches)							
	A	B	C	D	E	F	G	H
16 / 12	16±	90	2.0	16	12	10	16/12	4.0

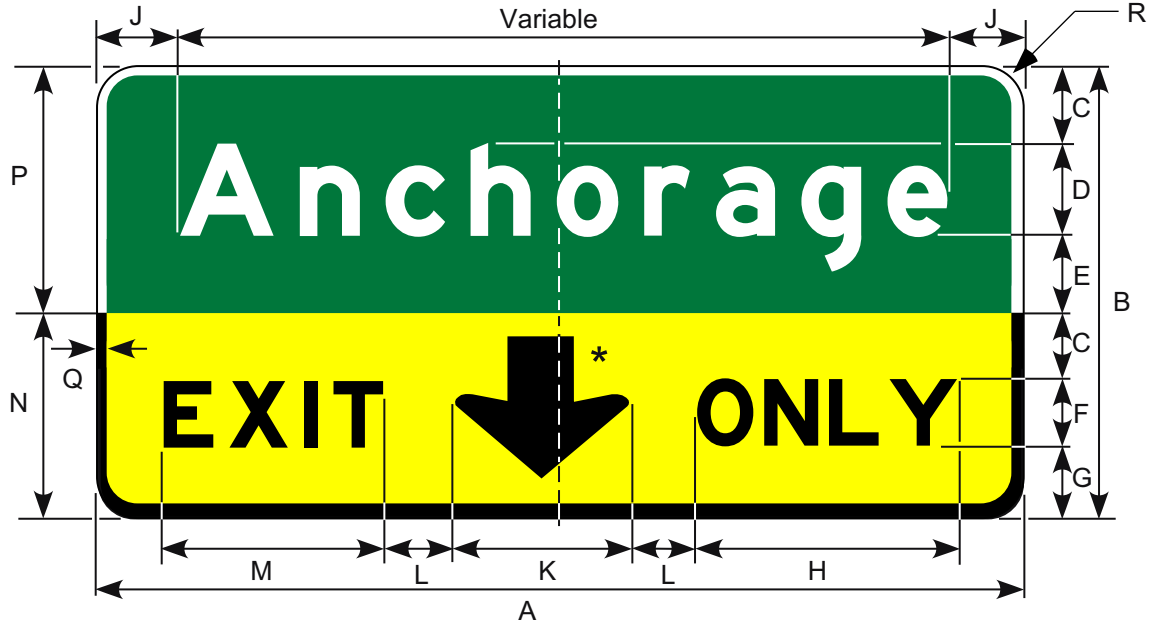

Upper Border and Legend: White
 Lower Border and Legend: Black
 Upper Background: Green
 Lower Background: Yellow

* See Appendix B-3 for Arrow Details.

For Overhead Mounting Only

Letter Size (inches)	Dimensions (inches)															
	A	B	C	D	E	F	G	H	J	K	L	M	N	P	Q	R
16 / 12	138 min	70	10	16/12	8.0	10	16	41	16±	32	8.0	33	36	34	2.0	4.0

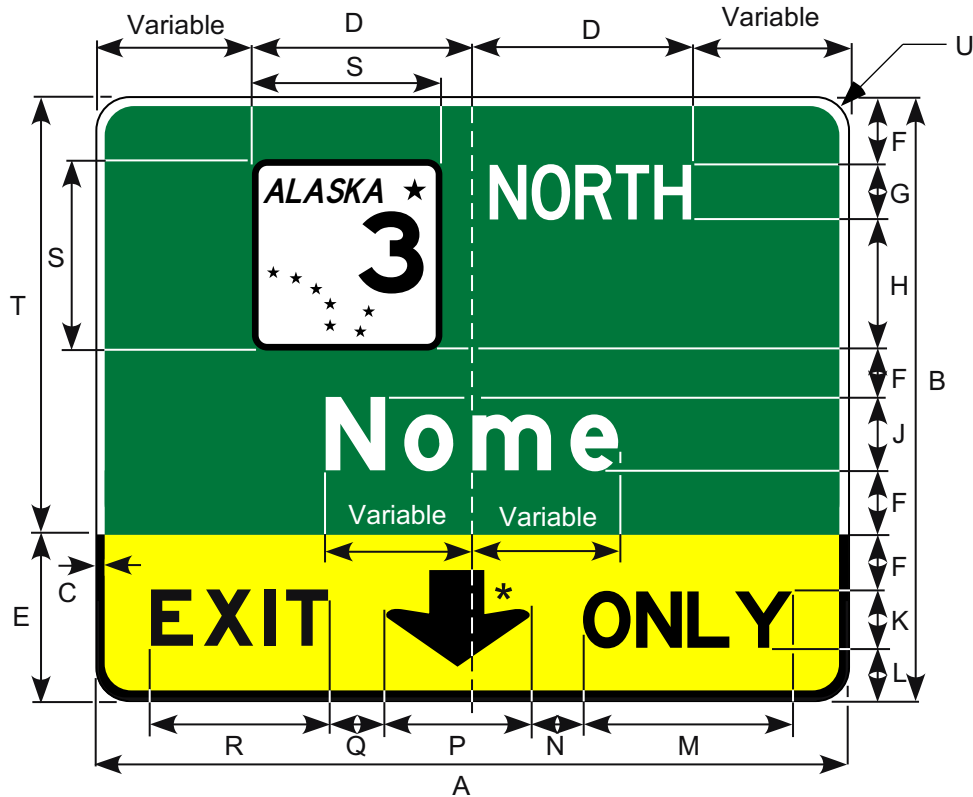

Upper Border and Legend: White
 Lower Border and Legend: Black
 Upper Background: Green
 Lower Background: Yellow
 Marker: Black on White

* See Appendix B-3 for
 Arrow Details.

Make symbol proportional
 to graphic shown

For Overhead Mounting Only

Letter Size (inches)	Dimensions (inches)										
	A	B	C	D	E	F	G	H	J	K	L
16 / 12	138 min.	118	2.0	50	36	10	12D	24	16/12	10D	16
	M	N	P	Q	R	S	T	U			
	41	8.0	32	8.0	33	36	82	4.0			

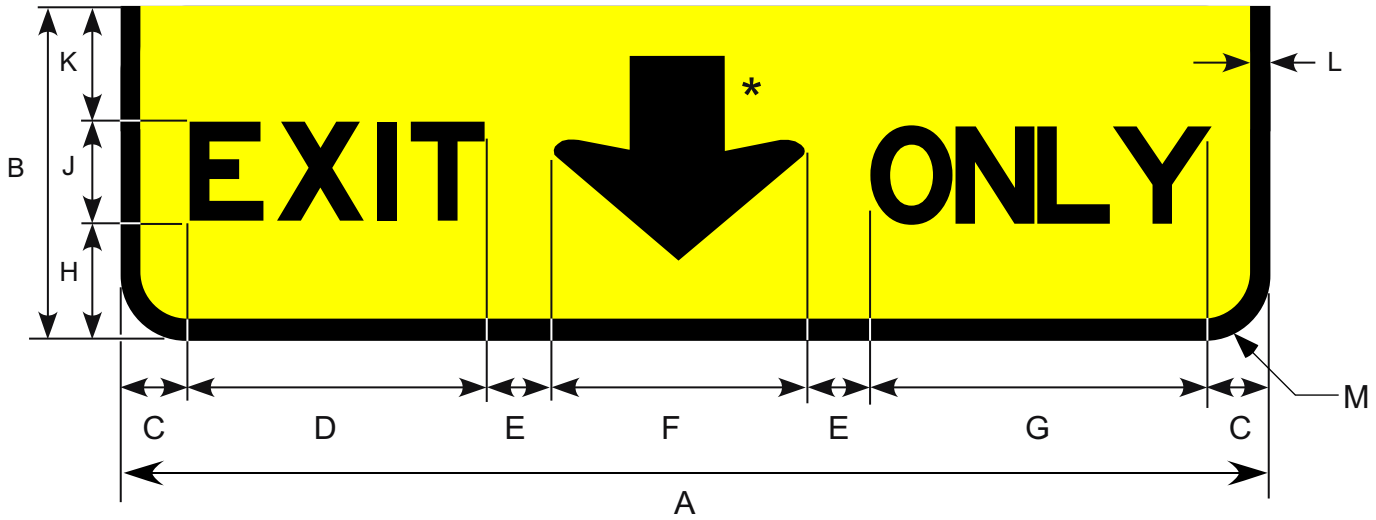

Border and Legend: Black
Background: Yellow

*See Appendix B-3 for Arrow Details.

For Overhead Mounting Only

Letter Size (inches)	Dimensions (inches)											
	A	B	C	D	E	F	G	H	J	K	L	M
10	138	36	8±	33	8.0	32	41	16	10D	10	2.0	4.0
12	168	36	12±	39	12	32	49	14	12D	10	2.0	4.0

EMERGENCY MANAGEMENT SIGNS

EM-2 to EM1-100

EM-2 EM-3

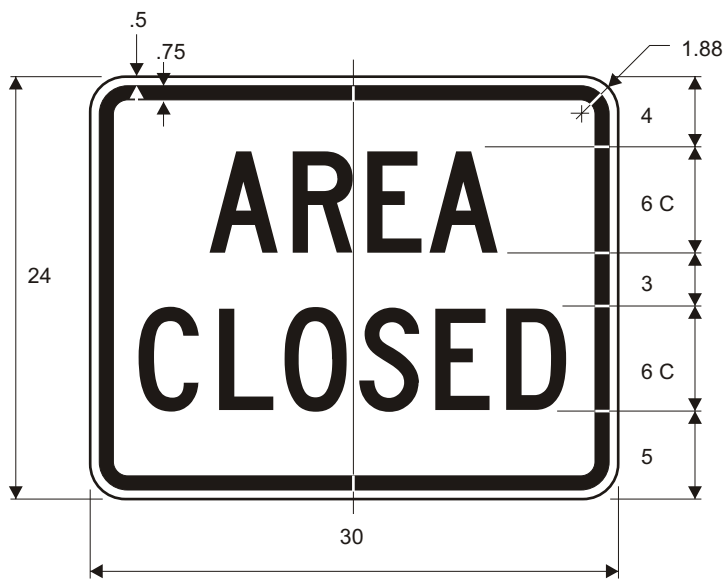

EM-2

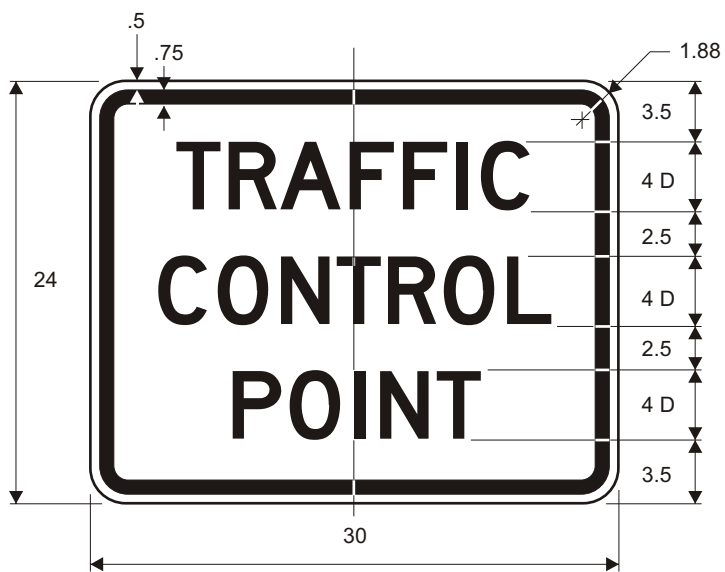

EM-3

Border and Legend: Black
Background: White

EM-4
EM-5



EM-4

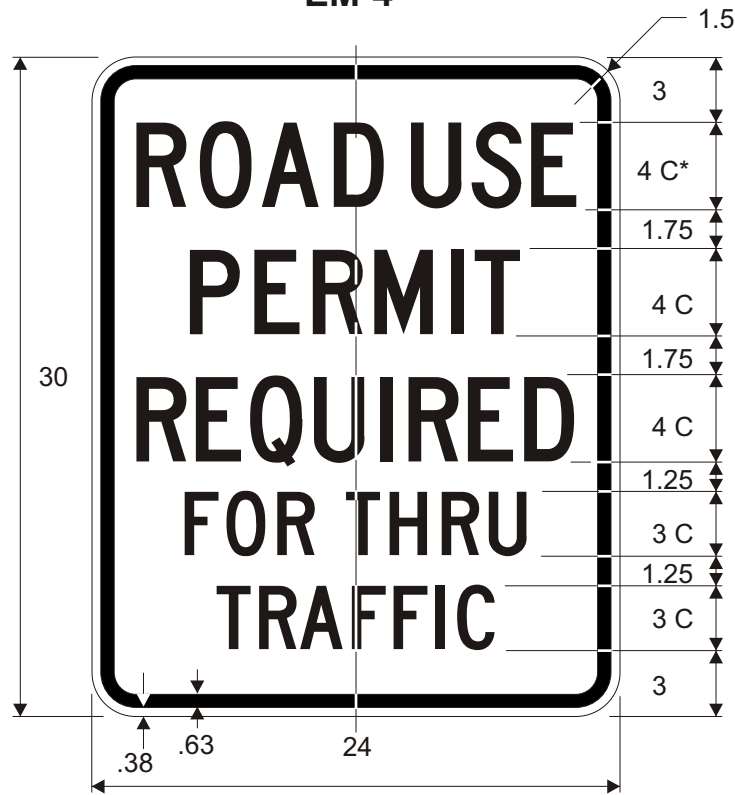

EM-5

*Reduce spacing to fit.

Border and Legend: Black
Background: White

EM-6A EM-6B

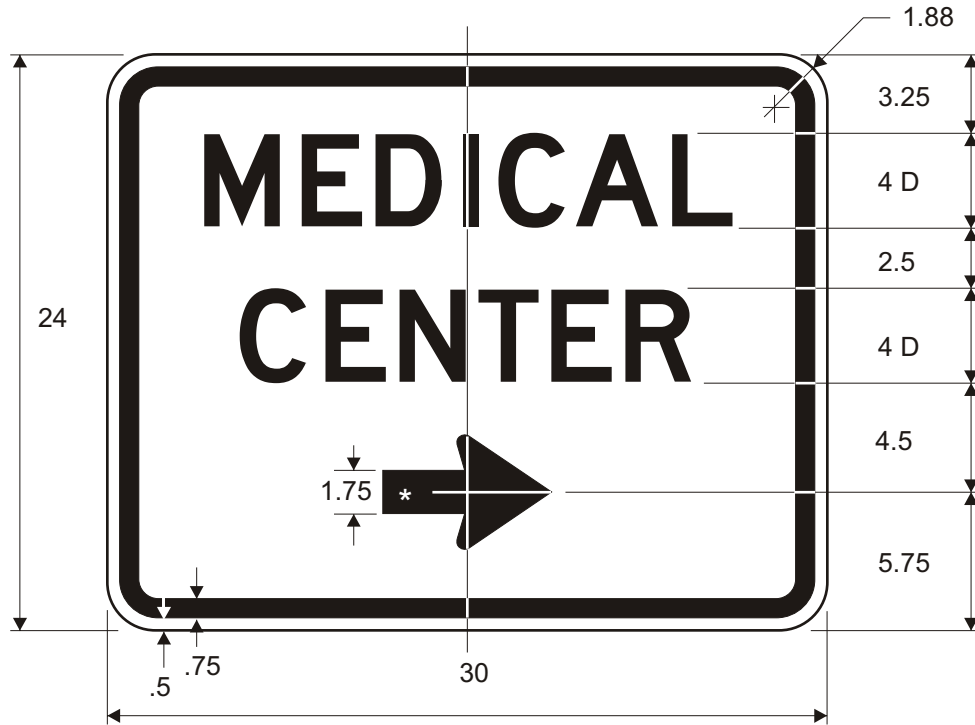

EM-6A

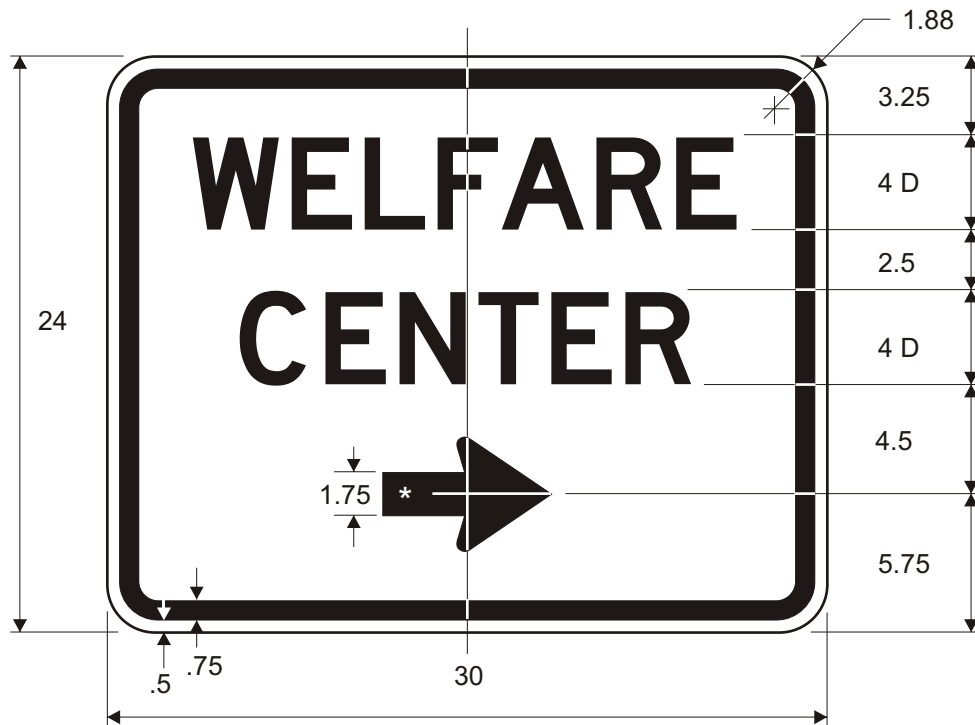

EM-6B

Border and Legend: Black
Background: White

*See Appendix B-1 for Standard Arrow Details.

EM-6C
EM-6D

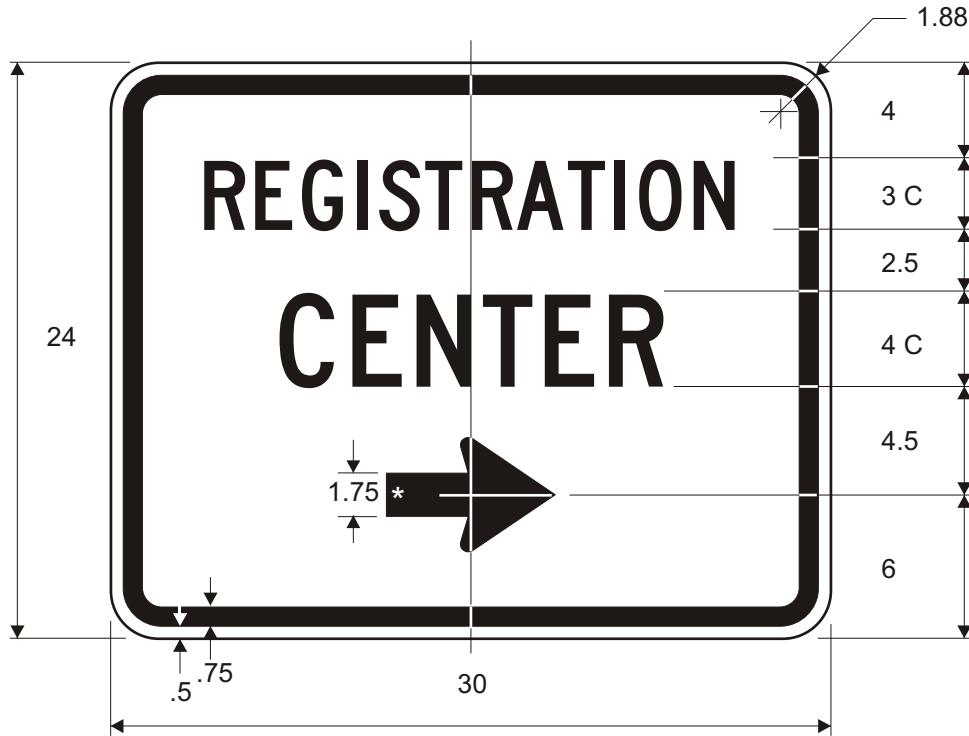

EM-6C

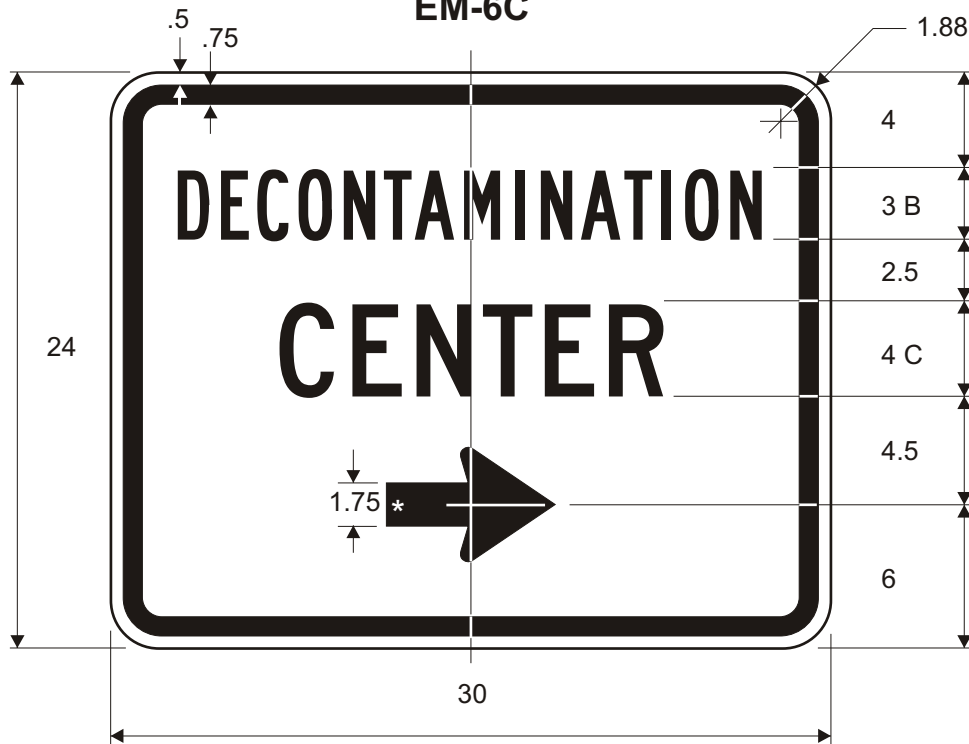

EM-6D

*See Appendix B-1 for Standard Arrow Details.

Border and Legend: Black
Background: White

EM-7A

EM-7B



EM-7A



EM-7B

*See Appendix B-1 for Standard Arrow Details.

Border and Legend: Black
Background: White

EM-7C
EM-7D



EM-7C



EM-7D

Border and Legend: Black
Background: White
CD Emblem: Yellow Triangles Inscribed in
a Black Circle Placed on a Yellow Square

*Reduce spacing to fit
**Optically locate arrow and mileage
characters about vertical centerline.
***See Appendix B-1 for Standard Arrow Details.

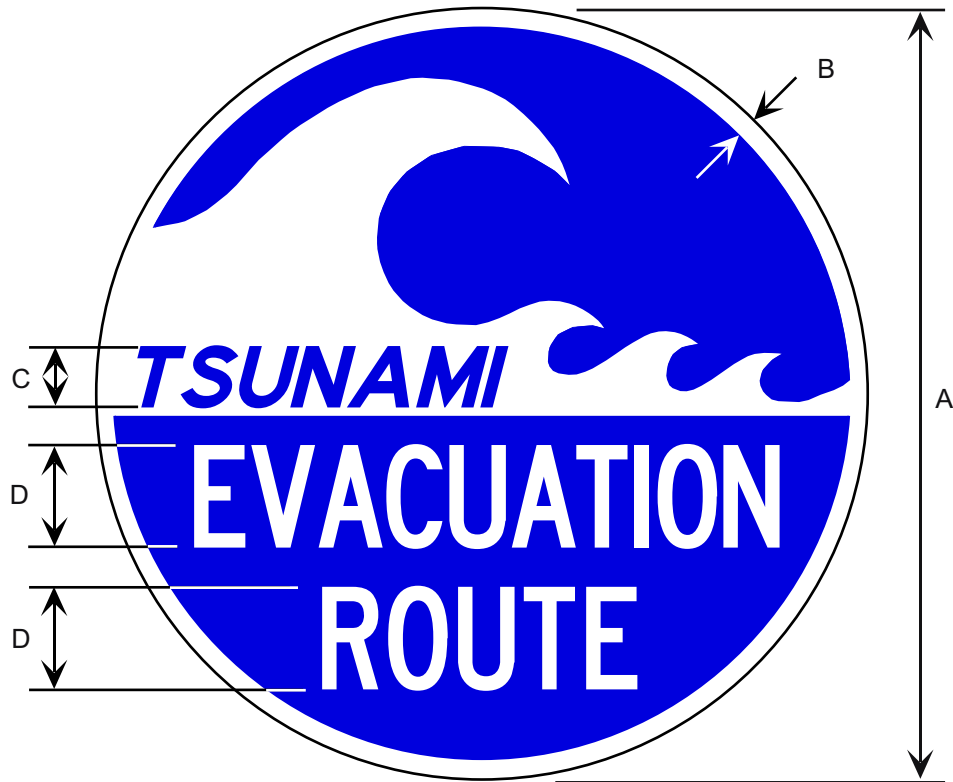

Border and Wave: White
 Background: Blue
 Legend: Blue/White

Make the symbol proportional
 to the one shown

Prior to the 2003 revision of this manual this sign was
 numbered CD-100 and previous to that AK-CD-1A.

Road Class	Dimensions (inches)			
	A	B	C	D
Conv & Min	24	0.63	2.0E Slant	3.0C
Special	36	0.88	2.5E Slant	4.0C

CONSTRUCTION GUIDE SIGNS

G20-1 to G20-4

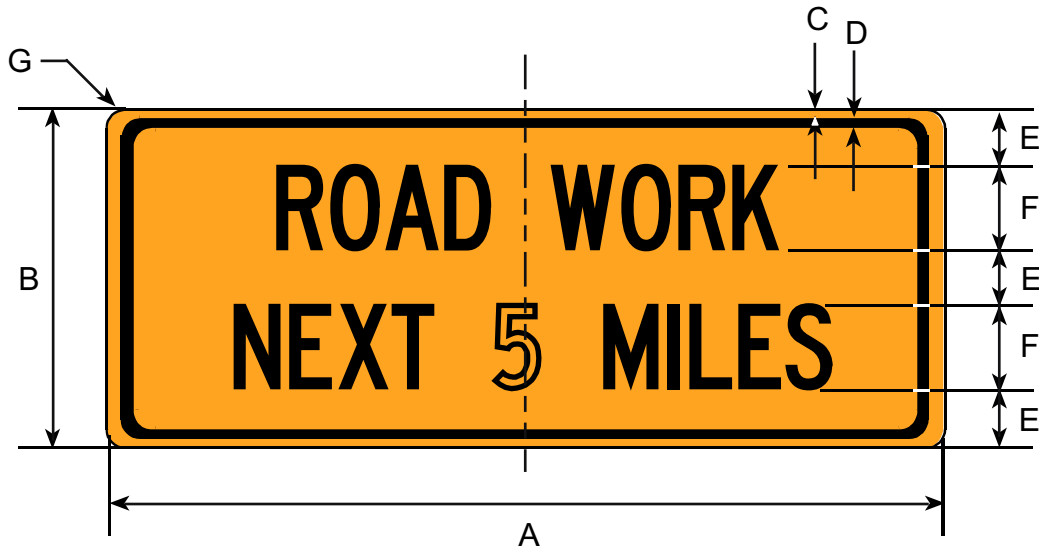

Border and Legend: Black
 Background: Orange

Road Class	Dimensions (inches)						
	A	B	C	D	E	F	G
Conven/ExpwyFwy	60	24	0.63	0.88	4	6C	3

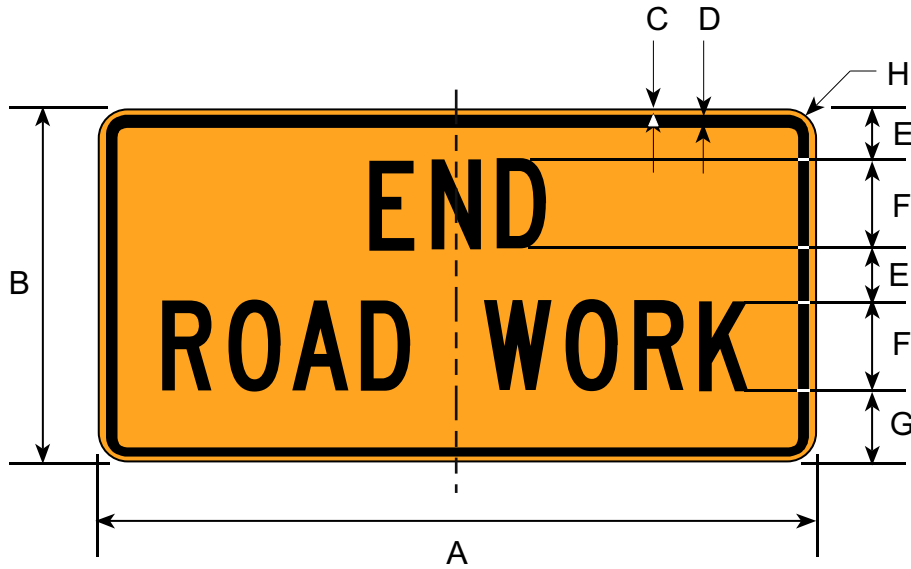

Border and Legend: Black
 Background: Orange

Prior to the 2003 revision of this manual
 this sign was numbered G20-2A.

Road Class	Dimensions (inches)							
	A	B	C	D	E	F	G	H
Conven/ExpwyFwy	48	24	0.38	0.63	3.75	6C	4.5	1.5

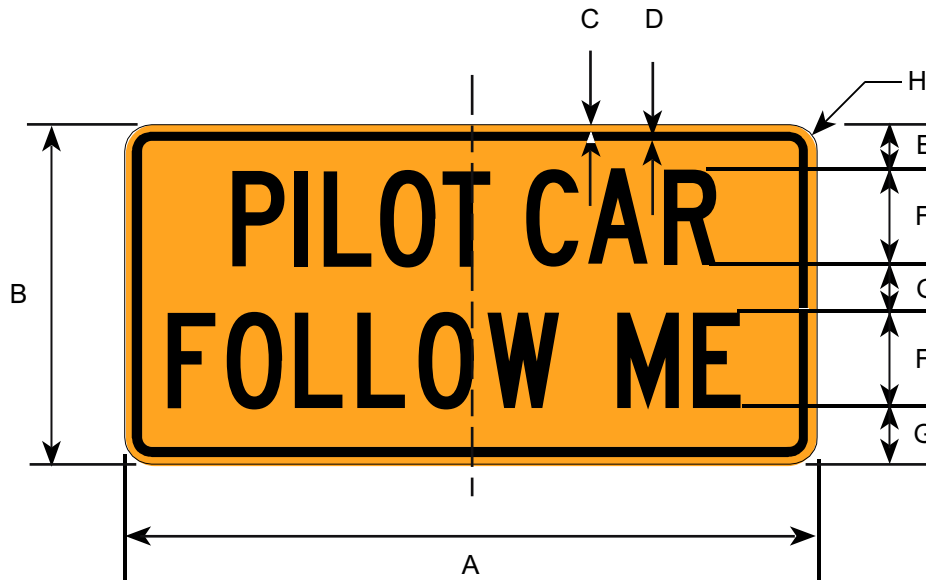

Border and Legend: Black
Background: Orange

Road Class	Dimensions (inches)							
	A	B	C	D	E	F	G	H
Conv & Min	36	18	0.38	0.63	2.5	5C	2.75	1.5

GENERAL INFORMATION SIGNS

I-1 to I-201

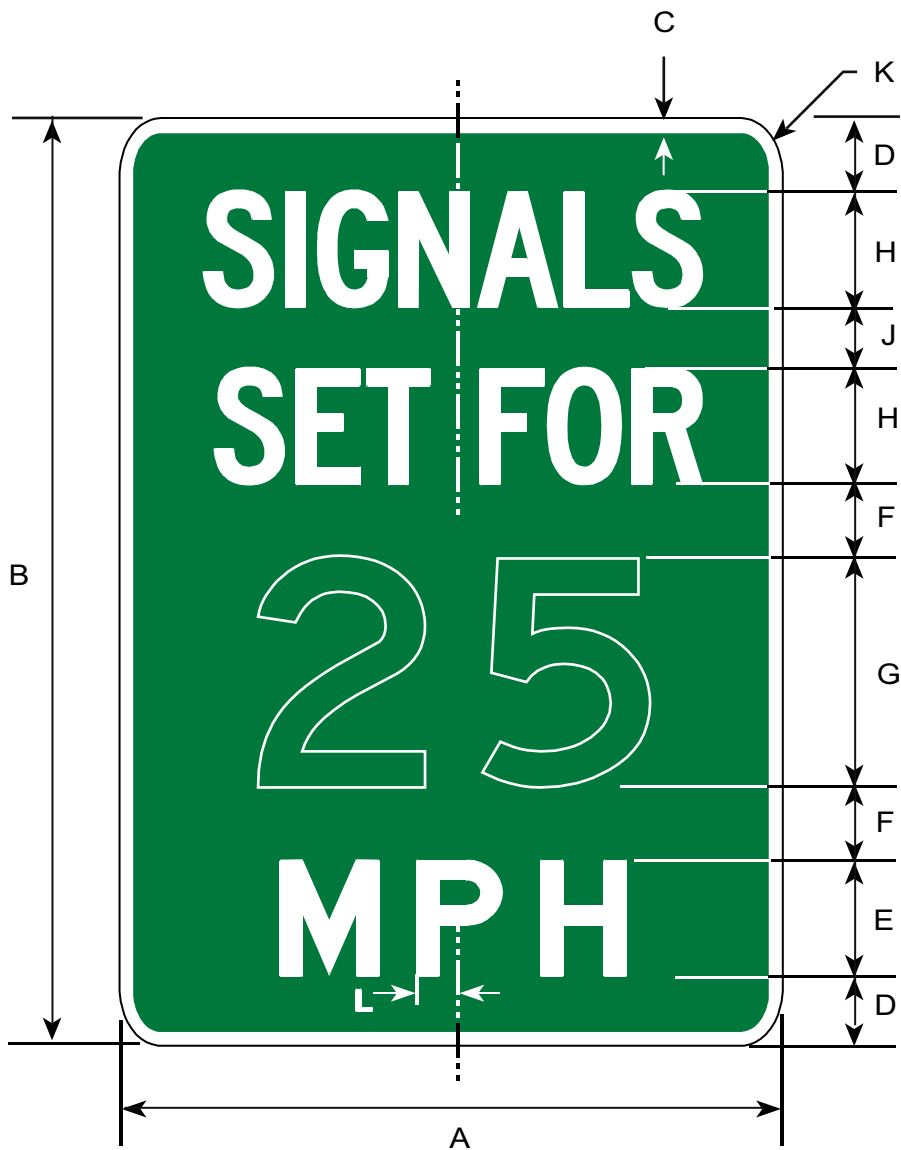

Border and Legend: White
Background: Green

Road Class	Dimensions (inches)										
	A	B	C	D	E	F	G	H	J	K	L
Conv & Min	12	18	0.5	2	2D	1	4D	2C	2	1.5	0.5

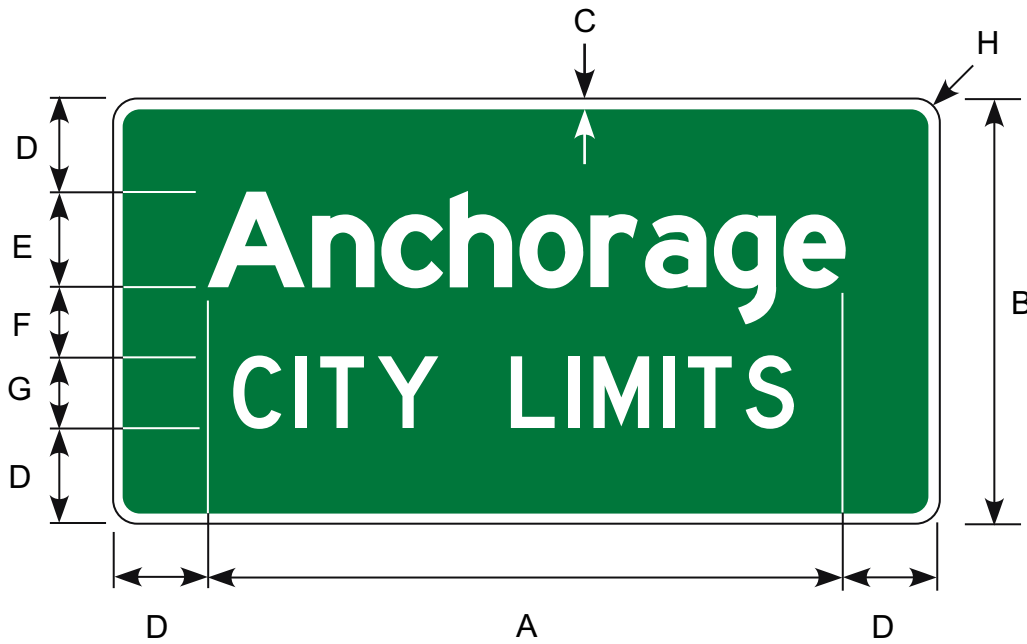

Border and Legend: White
 Background: Green

Road Class	Dimensions (inches)								
	A	B	C	D	E	F	G	H	
Conventional	VAR	36	2.0	8±	8/6	6.0	6D	2.25	

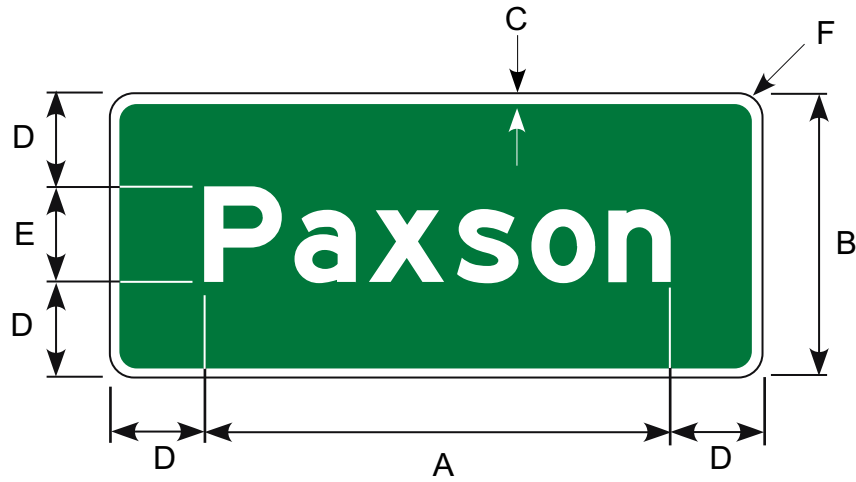

Border and Legend: White
Background: Green

Road Class	Dimensions (inches)					
	A	B	C	D	E	F
Conventional	VAR	24	0.75	8±	8/6	1.5

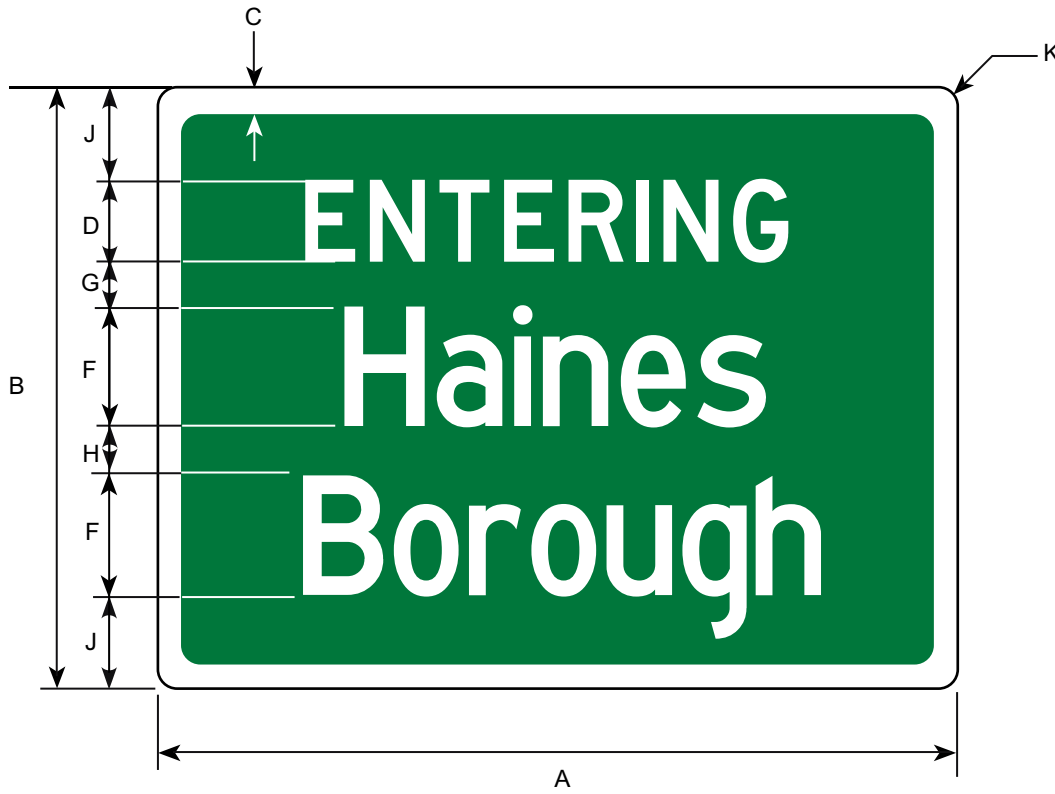

Border and Legend: White
 Background: Green

Road Class	Dimensions (inches)								
	A	B	C	D	F	G	H	J	K
Minimum	VAR	30	1.0	4D	6/4.5	3	3	4	1.88
Conventional	VAR	48	1.3	6D	8/6	6	6	7	3.00

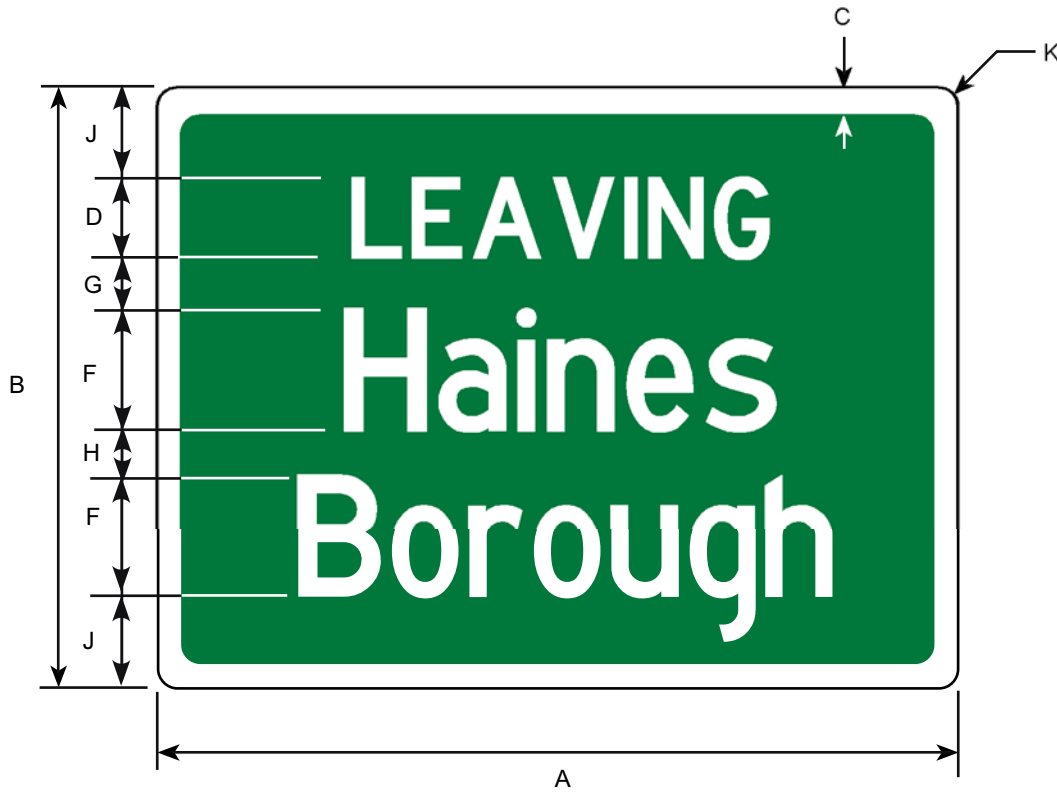

Border and Legend: White
Background: Green

Road Class	Dimensions (inches)								
	A	B	C	D	F	G	H	J	K
Minimum	VAR	30	1.00	4D	6/4.5	3	3	4	1.88
Conventional	VAR	48	1.25	6D	8/6	6	6	7	3.00

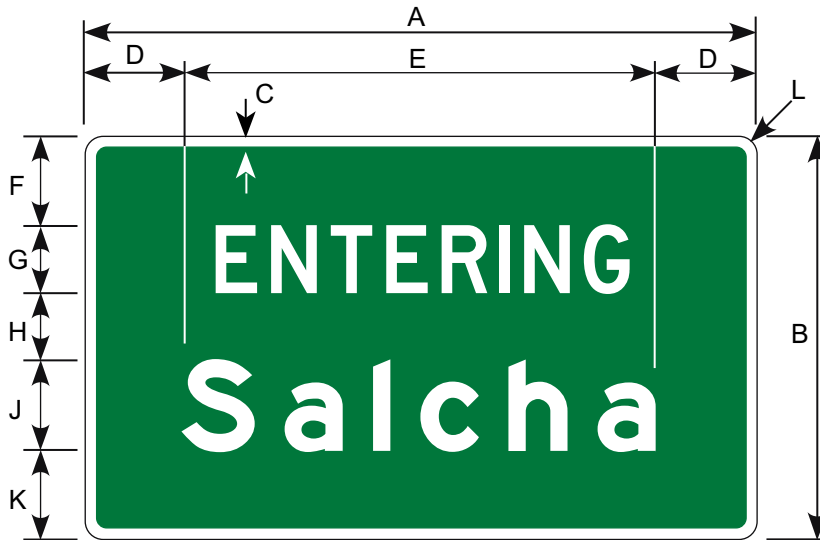

Border and Legend: White
 Background: Green

Road Class	Dimensions (inches)										
	A	B	C	D	E	F	G	H	J	K	L
Conventional	VAR	36	1.0	9±	VAR	8.0	6D	6.0	8/6	8.0	2.5

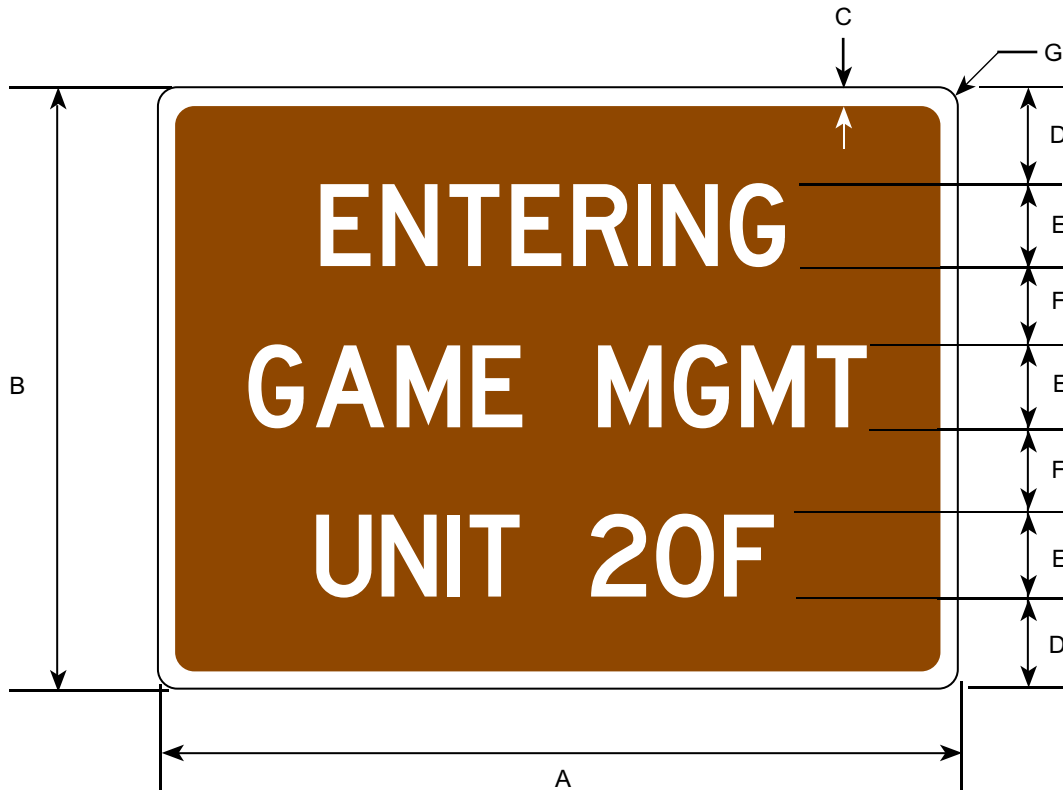

Border and Legend: White
Background: Brown

Road Class	Dimensions (inches)						
	A	B	C	D	E	F	G
Conv & Min	40	36	0.75	6	5D	4.5	2.25



Border and Legend: White
Background: Brown

Road Class	Dimensions (inches)						
	A	B	C	D	E	F	G
Conv & min	40	36	0.75	6	5D	4.5	2.25



Border and Legend: White
 Background: Green

Road Class	Dimensions (inches)						
	A	B	C	D	F	G	H
Minimum	VAR	24	0.75	6/4.5	4.00	4	1.50
Conventional	VAR	36	1.50	8/6	6.00	7	2.25
Expwy/Fwy	VAR	48	1.50	10.67/8	8.66	9	3.00

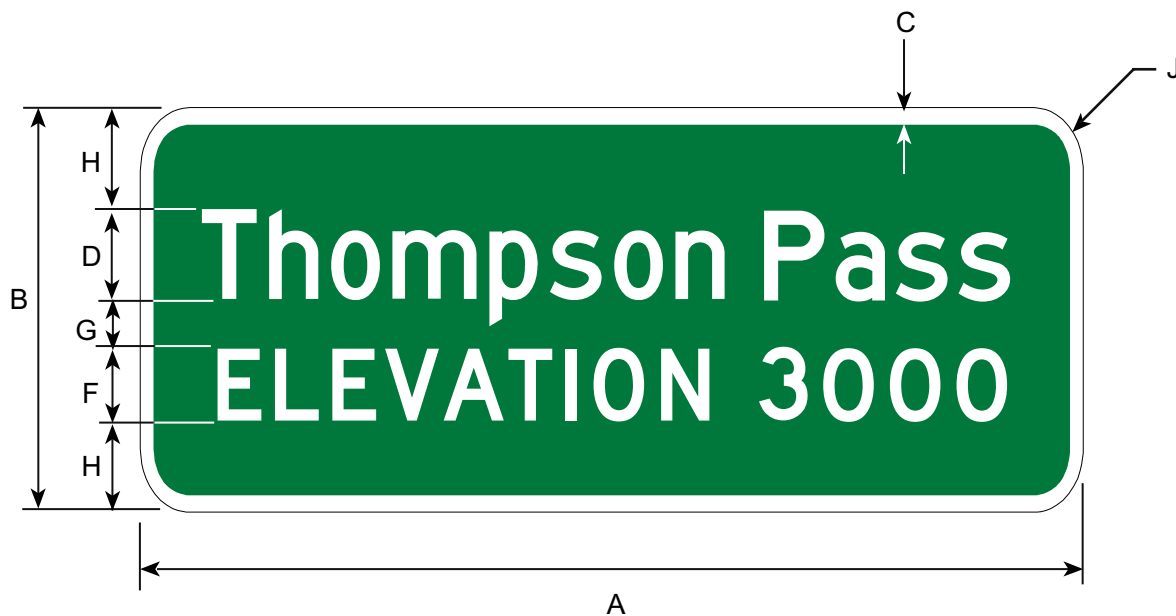

Border and Legend: White
 Background: Green

Road Class	Dimensions (inches)							
	A	B	C	D	F	G	H	J
Minimum	VAR	24	0.75	6/4.5	5D	5	4	1.50
Conventional	VAR	36	1.50	8/6	6D	6	8	2.25



Border and Legend: White
Background: Green

* See Appendix B-1 for Standard Arrow Details.

Name of Trail is variable.

Road Class	Dimensions (inches)															
	A	B	C	D	E	F	G	H	J	K	L	M	N	O	P	
Conv & Min	42	54	13.5	14	10.5	8.0	6.0	4.5	7.5	13	4C	5.0	5.0	6.0	7.0	
Expwy/Fwy	54	72	18.0	18	14.0	10.63	8.0	6.0	10	18	6C	6.0	6.0	9.0	9.0	
	Q	R	S	T	U	V	W									
	0.88	0.63	2.25	14	14	2.0	12									
	1.25	0.75	3.0	21	21	3.0	18									

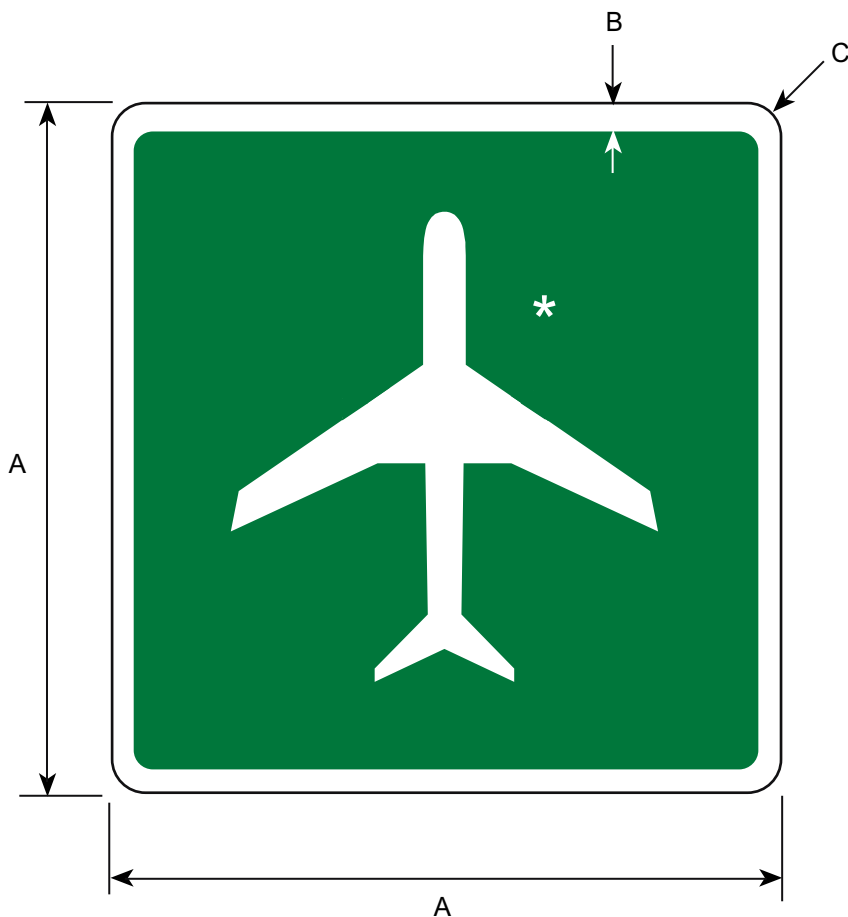

*Make the symbol proportional to the graphic shown.

Border and Legend: White
Background: Green

Rotate as appropriate to indicate direction to airport.

Road Class	Dimensions (inches)		
	A	B	C
Minimum	24	0.50	1.50
Conventional	30	0.75	1.88

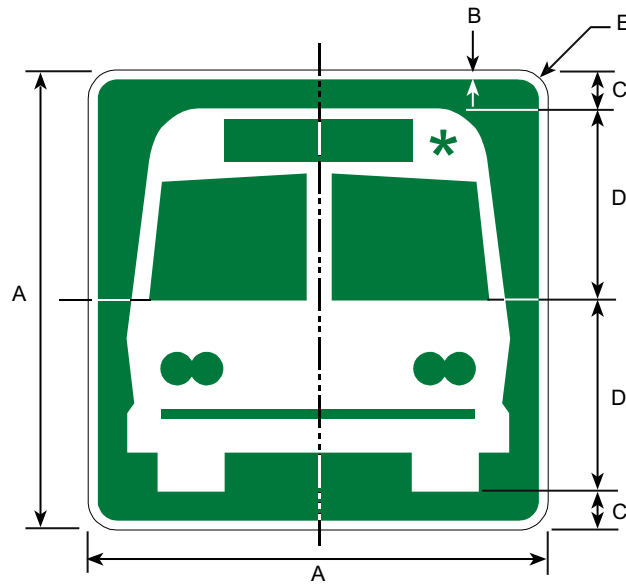

*Make the symbol proportional to the graphic shown.

Border and Legend: White
Background: Green

Road Class	Dimensions (inches)				
	A	B	C	D	E
Minimum	24	0.50	3.00	9.00	1.50
Conventional	30	0.75	3.75	11.25	1.88

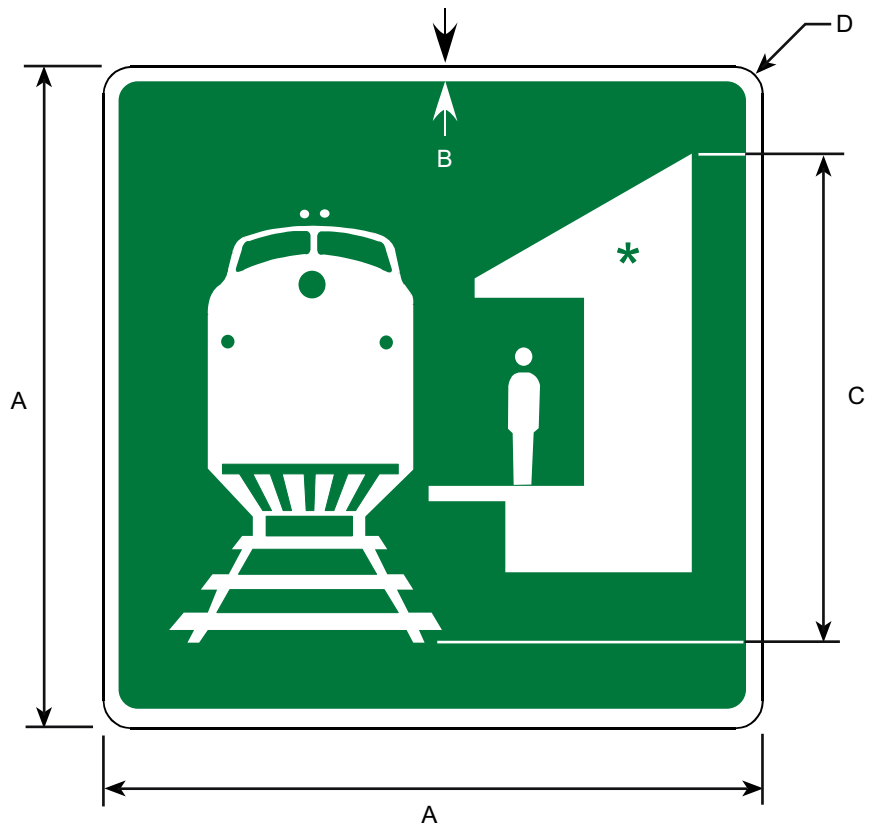

*Make symbol proportional to the graphic shown.

Border and Legend: White
Background: Green

Road Class	Dimensions (inches)			
	A	B	C	D
Minimum	24	0.5	18.0	1.5
Conventional	30	0.75	22.5	1.88

**I-8
I-8P**

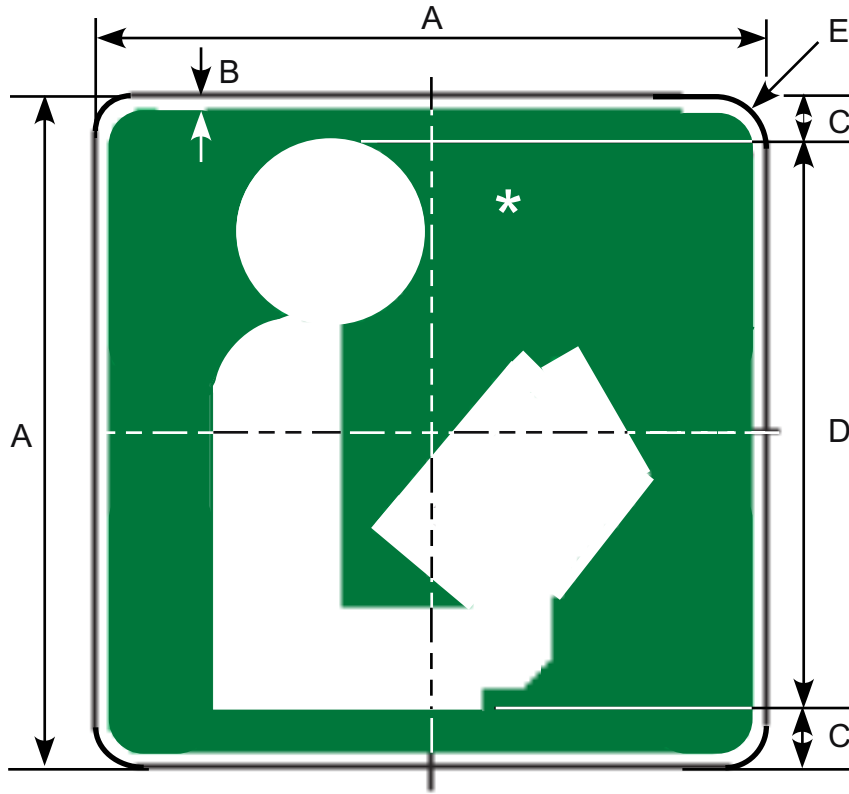

I-8

Road Dimensions (inches)

Class	A	B	C	D	E
Minimum	18	0.50	1.5	15	1.50
Conventional	24	0.50	2.0	20	1.50
Expressway	30	0.75	2.5	25	1.88

Border and Legend: White * Make symbol proportional to the one shown.
Background: Green

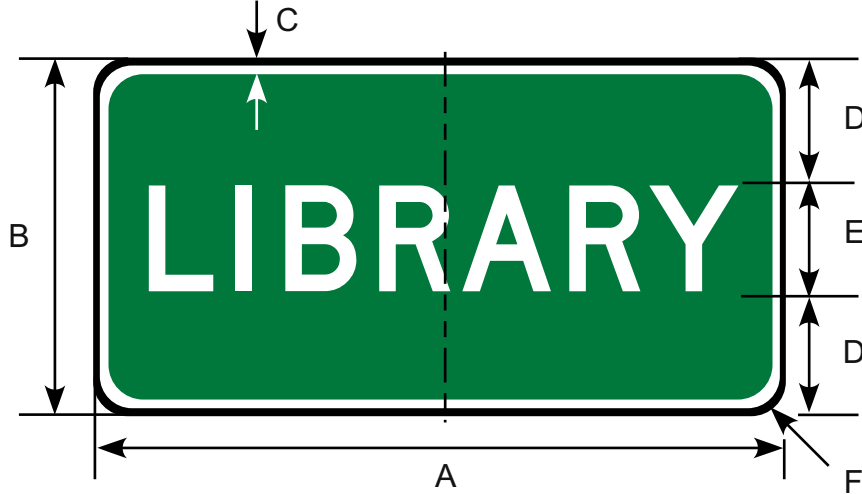

I-8P

Road Dimensions (inches)

Class	A	B	C	D	E	F
Minimum	18	9	0.5	3	3D	1.5
Conventional	24	12	0.5	4	4C	1.5
Expressway	30	15	0.75	5	5C	1.88



Border and Legend: White
Background: Green

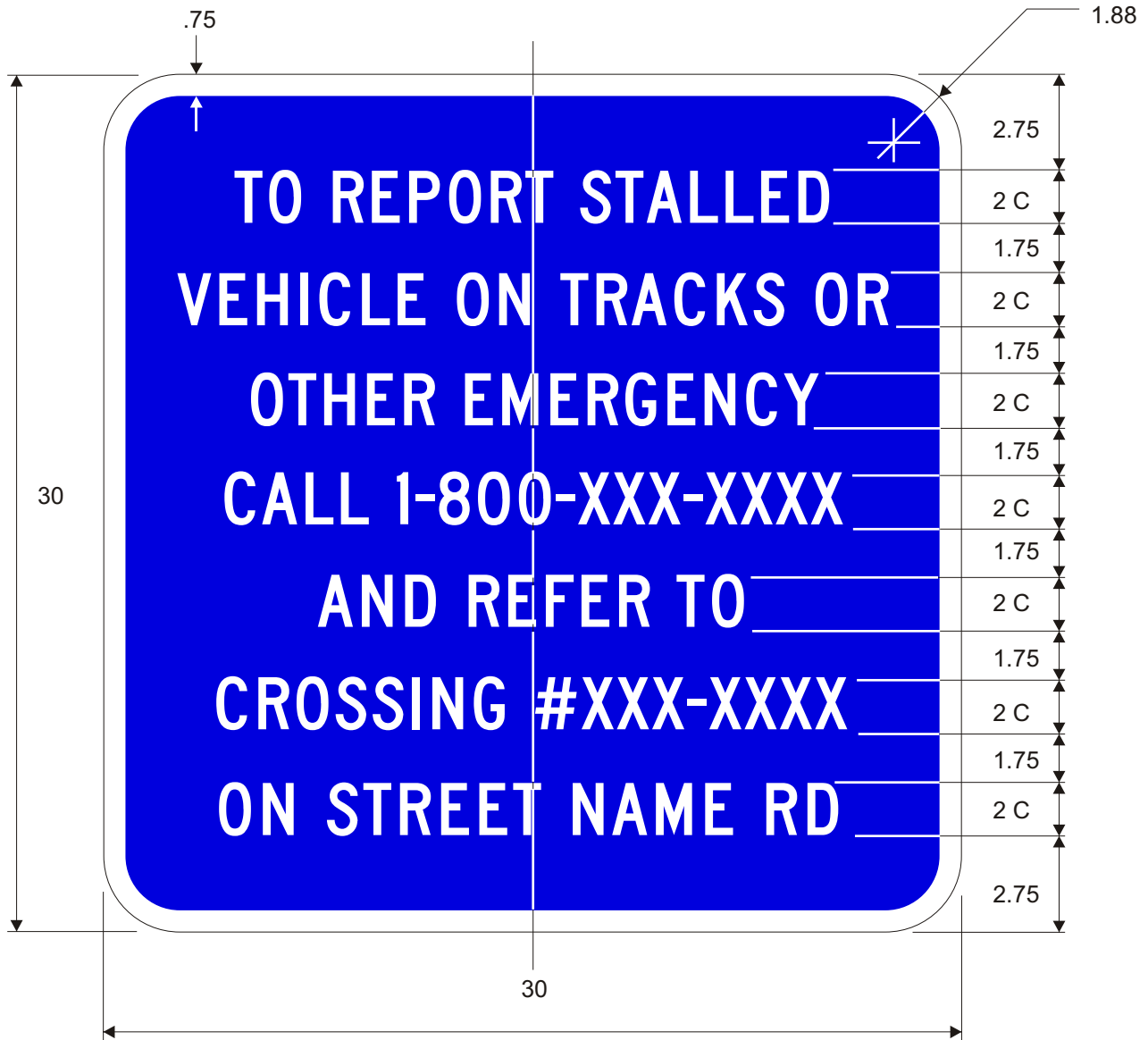

Border and Legend: White
Background: Blue

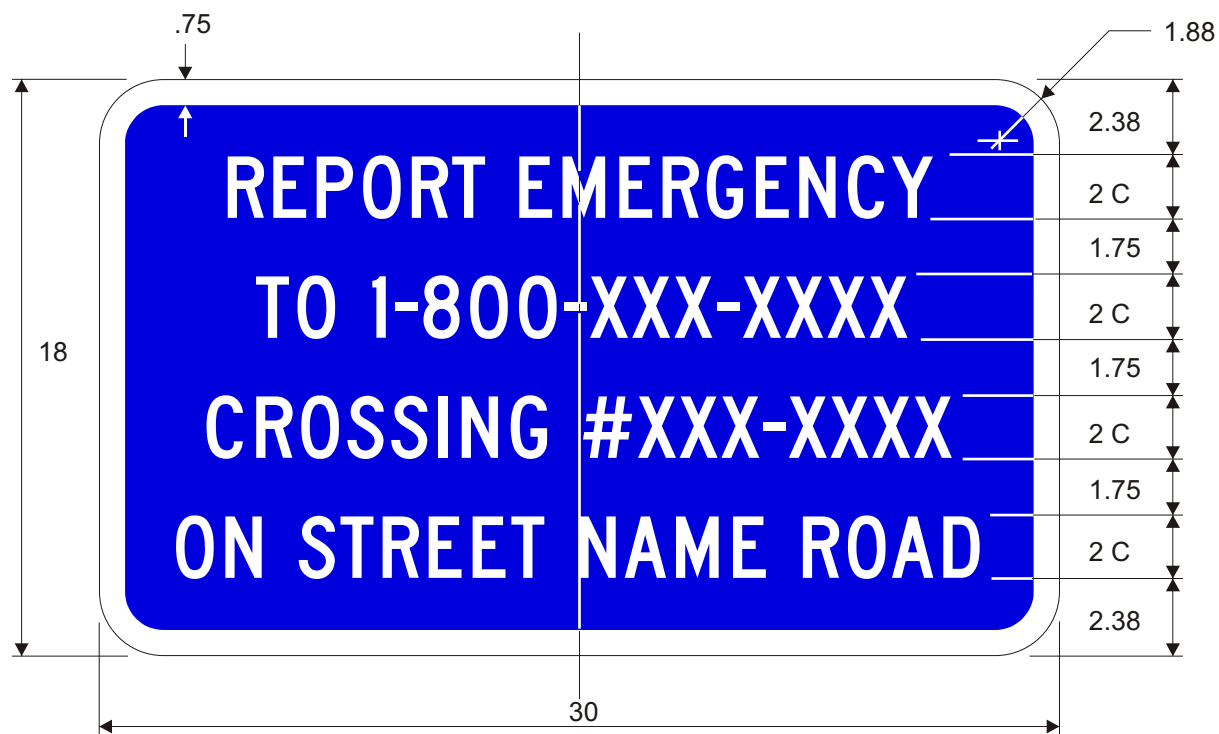

Border and Legend: White
 Background: Blue

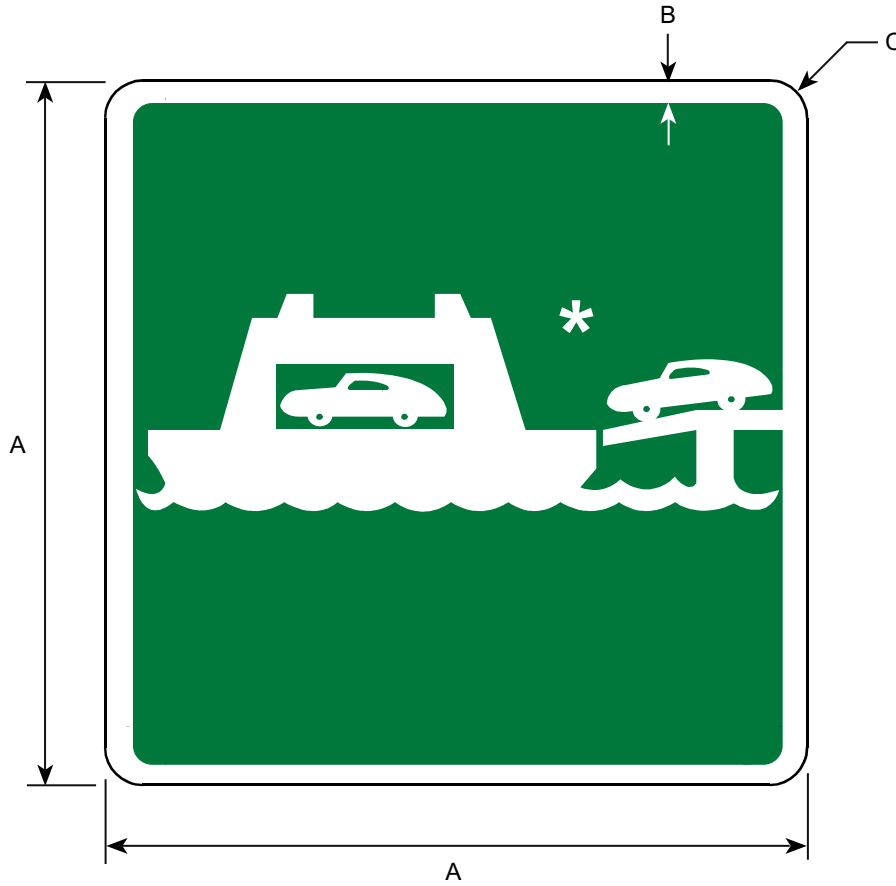

*Make symbol proportional to graphic shown.

Border and Legend: White
Background: Green

Prior to 2002 publication of this manual, this sign was numbered I-08.

Dimensions (inches)			
Road Class	A	B	C
Minimum	24	0.50	1.50
Conventional	30	0.75	1.88



Border and Legend: White
Background: Green

Road Class	Dimensions (inches)								
	A	B	C	D	E	F	G	H	J
Conventional	VAR	36	2.0	8±	6D	6.0	8/6	51.5	2.25

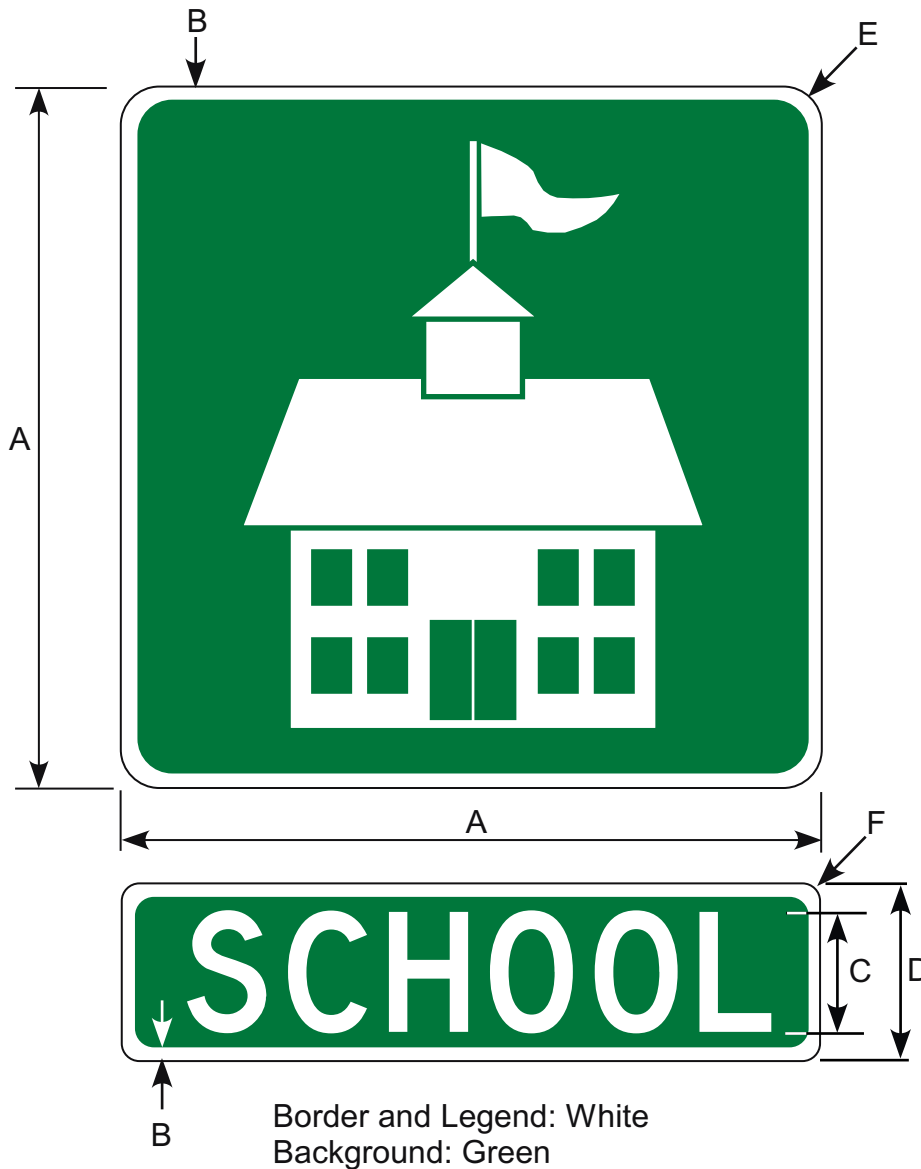

Make symbol proportional to graphic shown

If school names are shown instead of "SCHOOL" on the plate, use 4" Series C letters until the plate exceeds the width of the symbol sign. At greater widths, use 4" Series B. One, two, and three line signs should be 12", 18", and 24" high, respectively for both minimum and conventional road classes.

Road Class	Dimensions (inches)					
	A	B	C	D	E	F
Min	24	0.50	5C	12	1.5	0.50
Conv	30	0.75	6C	12	1.88	0.75

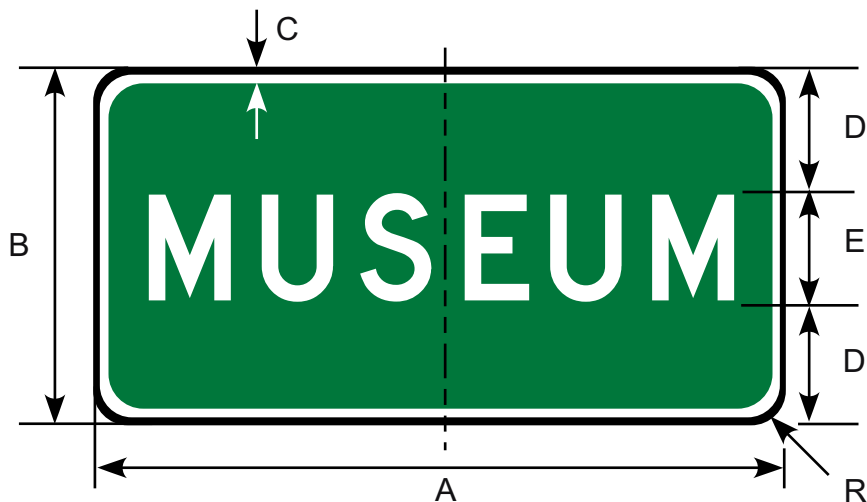

Border and Legend: White
 Background: Green or Brown

Road Class	Dimensions (inches)					
	A	B	C	D	E	R
Conv & Min	24	12	0.50	4.0	4C	1.5

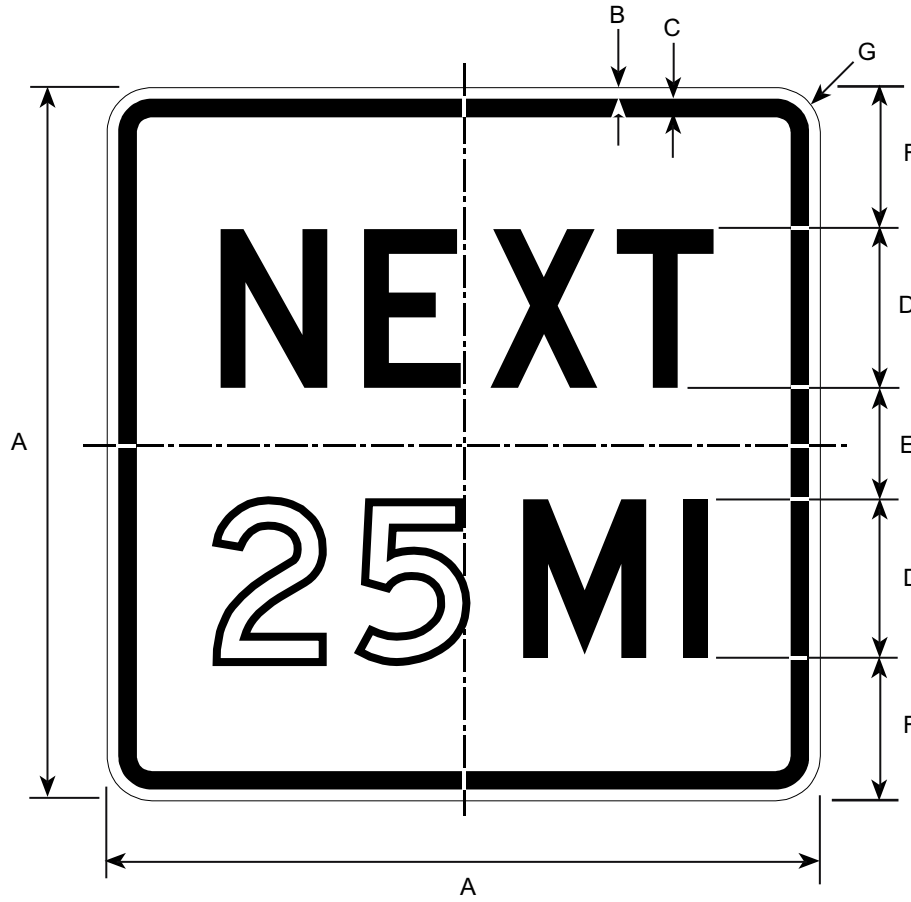

Border and Legend: Black
Background: White

Road Class	Dimensions (inches)						
	A	B	C	D	E	F	G
Min & Conv	18	0.38	0.5	4D	3	3.5	1.5

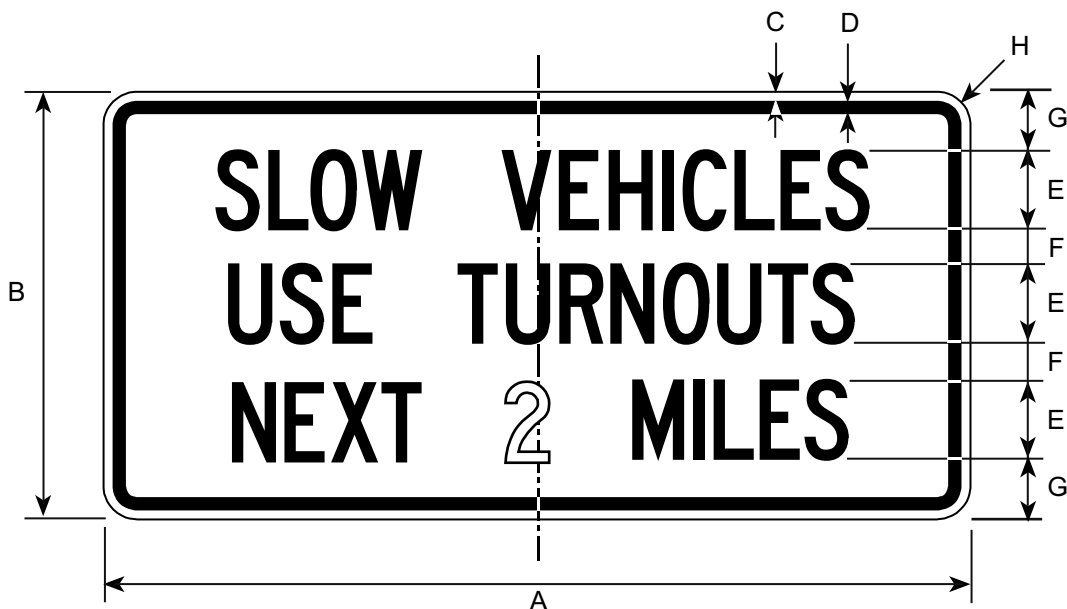

Border and Legend: Black
Background: White

Prior to 2002 publication of this manual,
this sign was numbered D9-22B.

Road Class	Dimensions (inches)							
	A	B	C	D	E	F	G	H
Min & Conv	72	36	0.75	1.25	6C	4	5	2.25

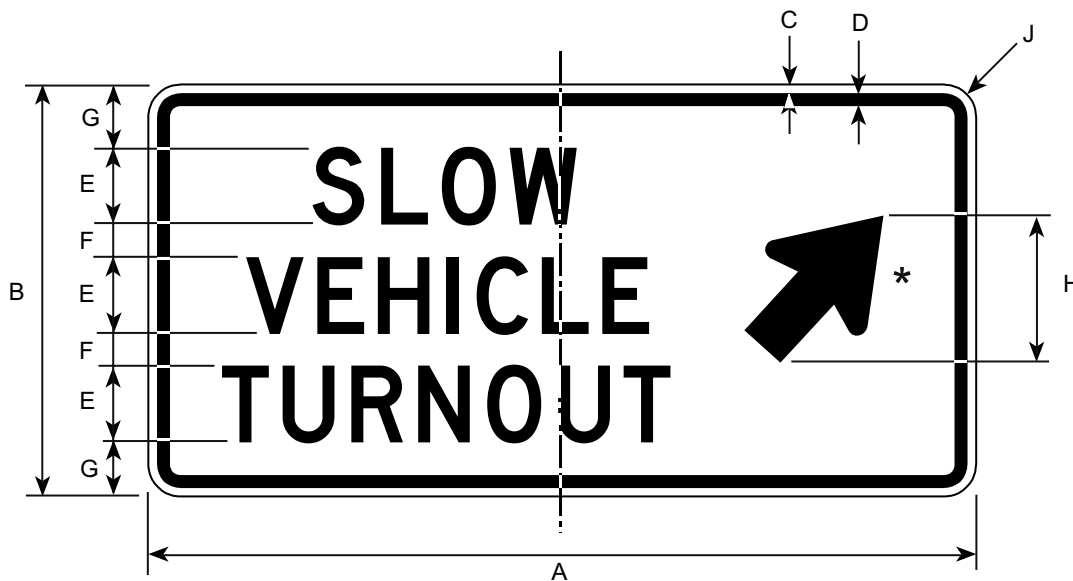

Border and Legend: Black
Background: White

* See Appendix B-4 for Arrow Details.

Prior to 2002 publication of this manual,
this sign was numbered D9-22A.

Road Class	Dimensions (inches)									
	A	B	C	D	E	F	G	H	J	
Min & Conv	72	36	0.75	1.25	6D	4.0	5.0	10.31	2.25	

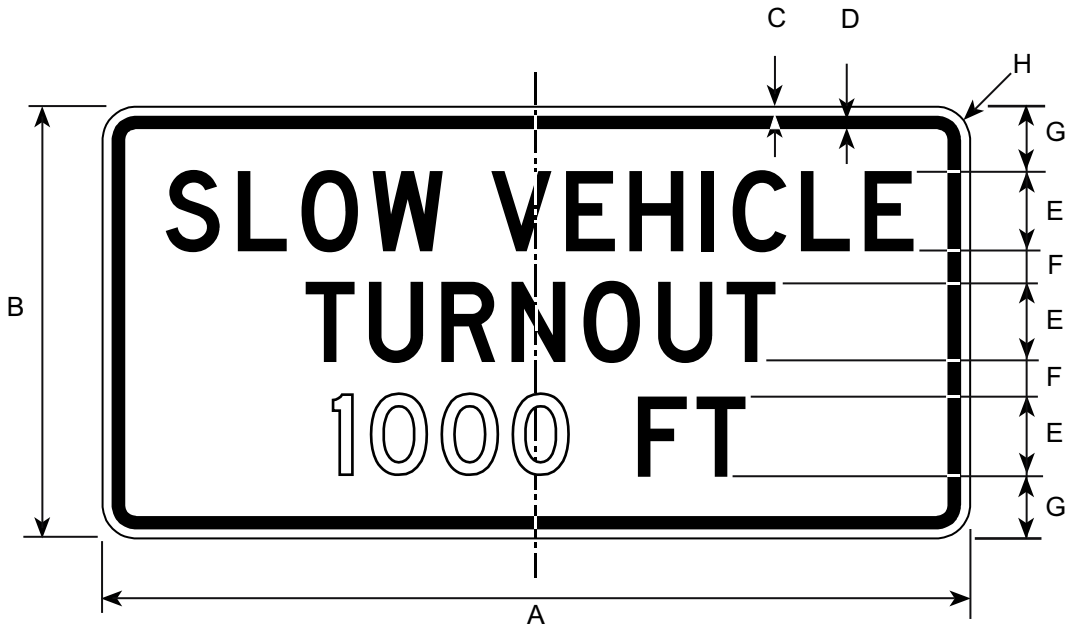

Border and Legend: Black
Background: White

Prior to 2002 publication of this manual,
this sign was numbered D9-22.

Road Class	Dimensions (inches)							
	A	B	C	D	E	F	G	H
Min & Conv	72	36	0.75	1.25	6D	4	5	2.25

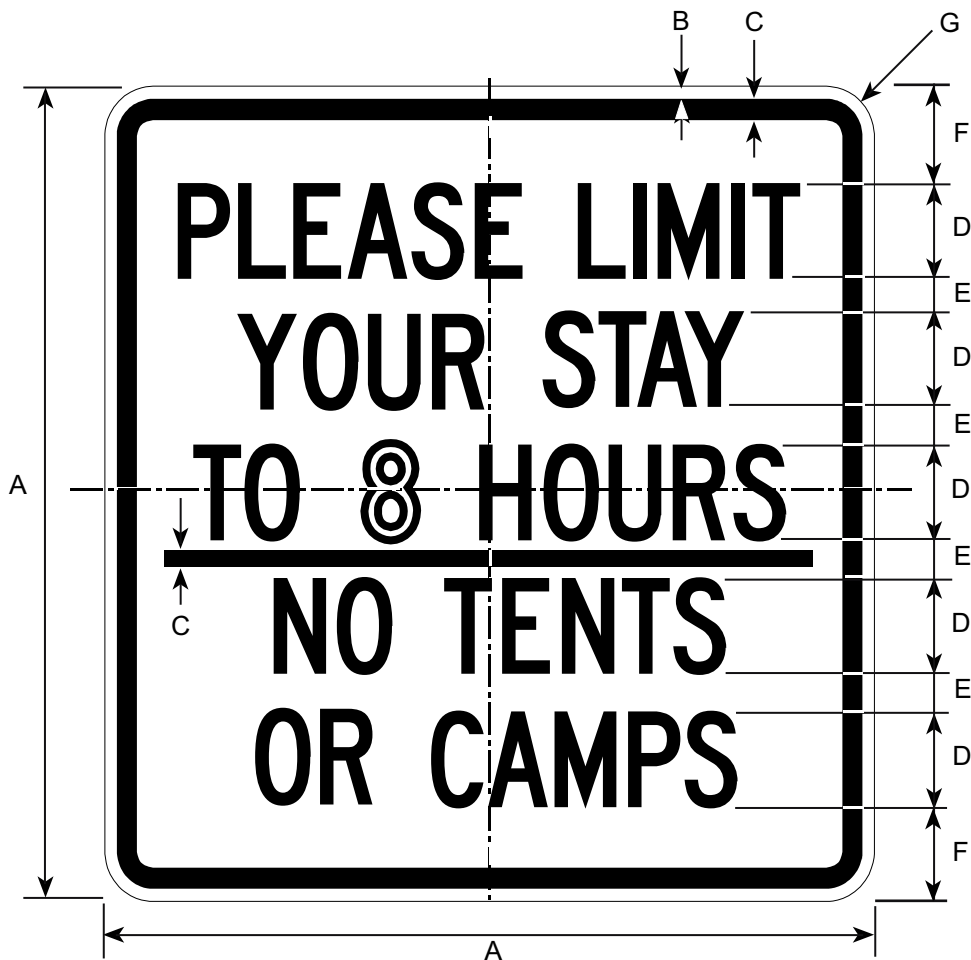

Border and Legend: Black
 Background: White

Road Class	Dimensions (inches)						
	A	B	C	D	E	F	G
Min & Conv	36	0.38	0.63	4C	2	4	2.25

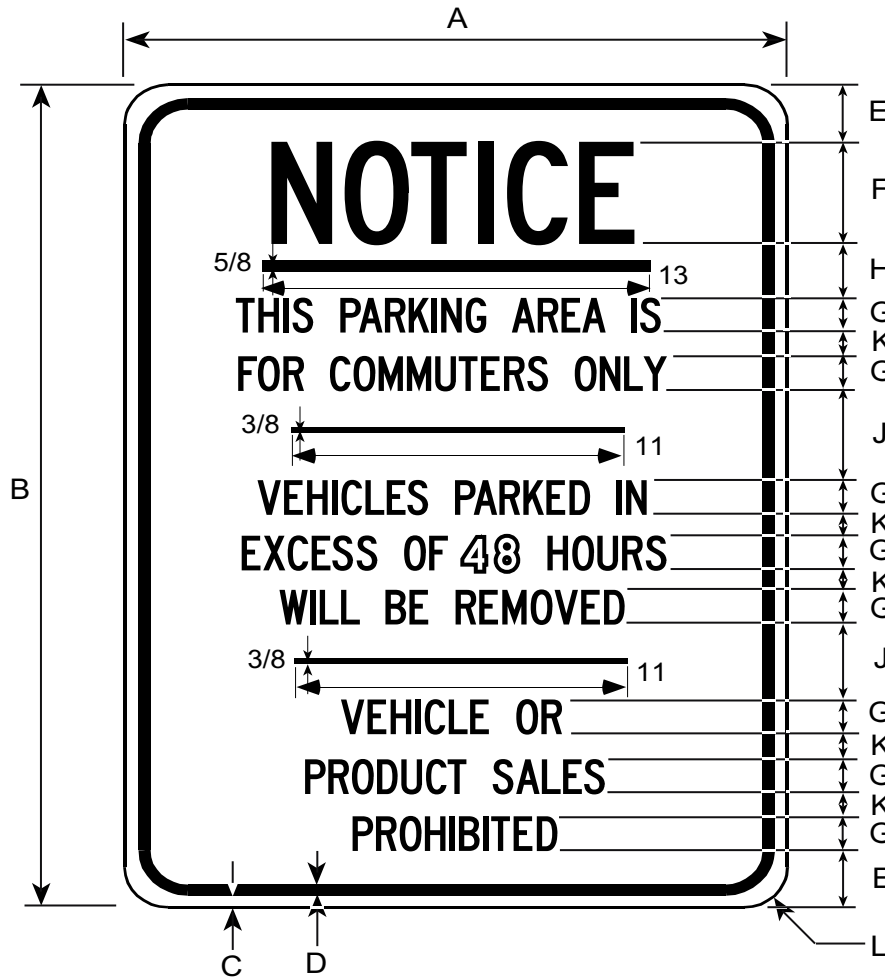

Border and Legend: Black
Background: White

Road Class	Dimensions (inches)										
	A	B	C	D	E	F	G	H	J	K	L
Min & Con	18	24	0.38	0.63	2.0	3C	1C	2.0	1.5	0.8	1.5

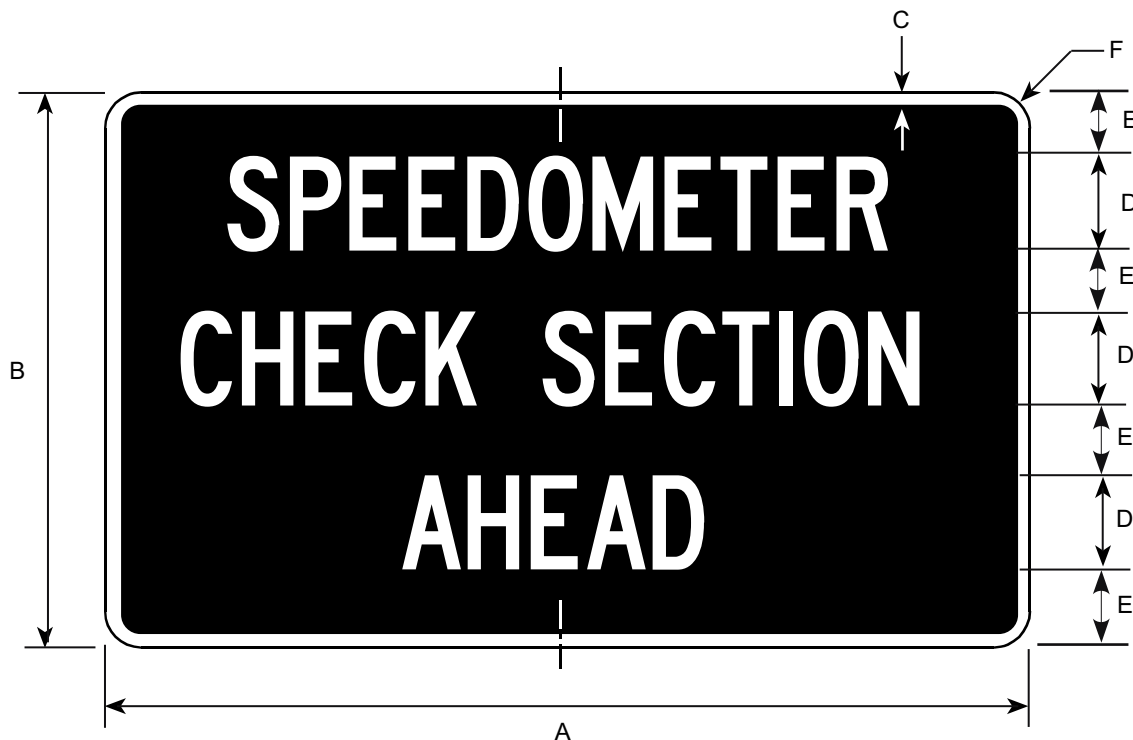

Border and Legend: White
 Background: Black

Road Class	Dimensions (inches)					
	A	B	C	D	E	F
Min & Conv	60	36	2	6C	4.5	2.25

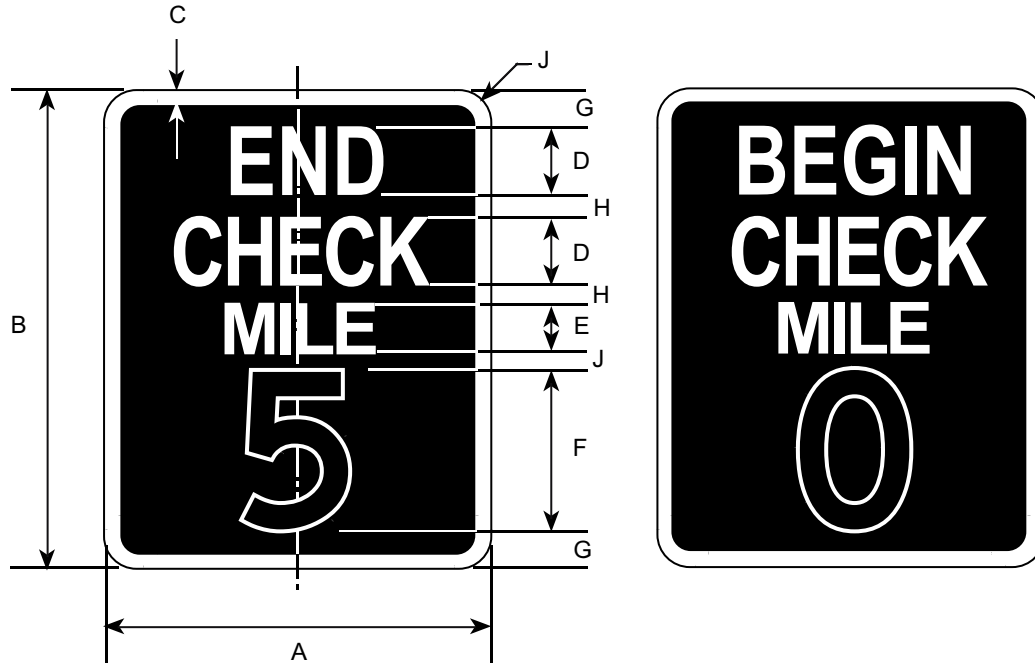

I-141E

I-141B

Border and Legend: White
Background: Black

Prior to the 2002 publication of this manual,
I-141E was M9-3 and I-141B was M9-1.

Miles are variable

Road Class	Dimensions (inches)									
	A	B	C	D	E	F	G	H	J	
Min & Conv	24	30	0.50	4D	3D	10D	2.0	1.75	1.5	

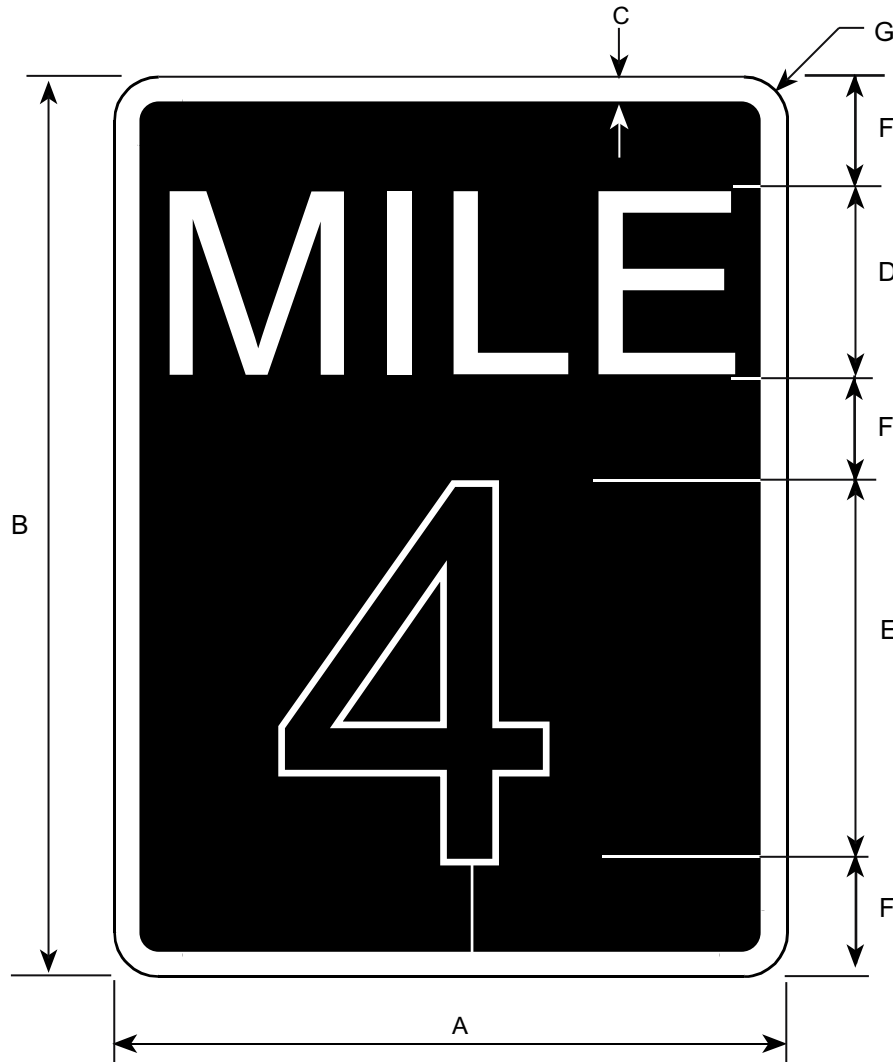

Border and Legend: White
Background: Black

Prior to the 2002 publication of this manual,
this sign was numbered M9-2.

Road Class	Dimensions (inches)						
	A	B	C	D	E	F	G
Min & Conv	18	24	0.5	5D	10D	3	1.5



This drawing has been replaced with:
 I-150
 ADOPT A HIGHWAY
 (08/04/09).

Click on the drawing number in the
 upper right corner to go to the Interim
 Addenda web page.

Border and Legend: White
 Background: Blue

Road Class	Dimensions (inches)									
	A	B	C	D	E	F	G	H	J	
Minimum	24	18	12	0.75	3C	3.0	2	3C	1.5	
Conventional	30	24	12	0.75	4C	4	2	3C	2	

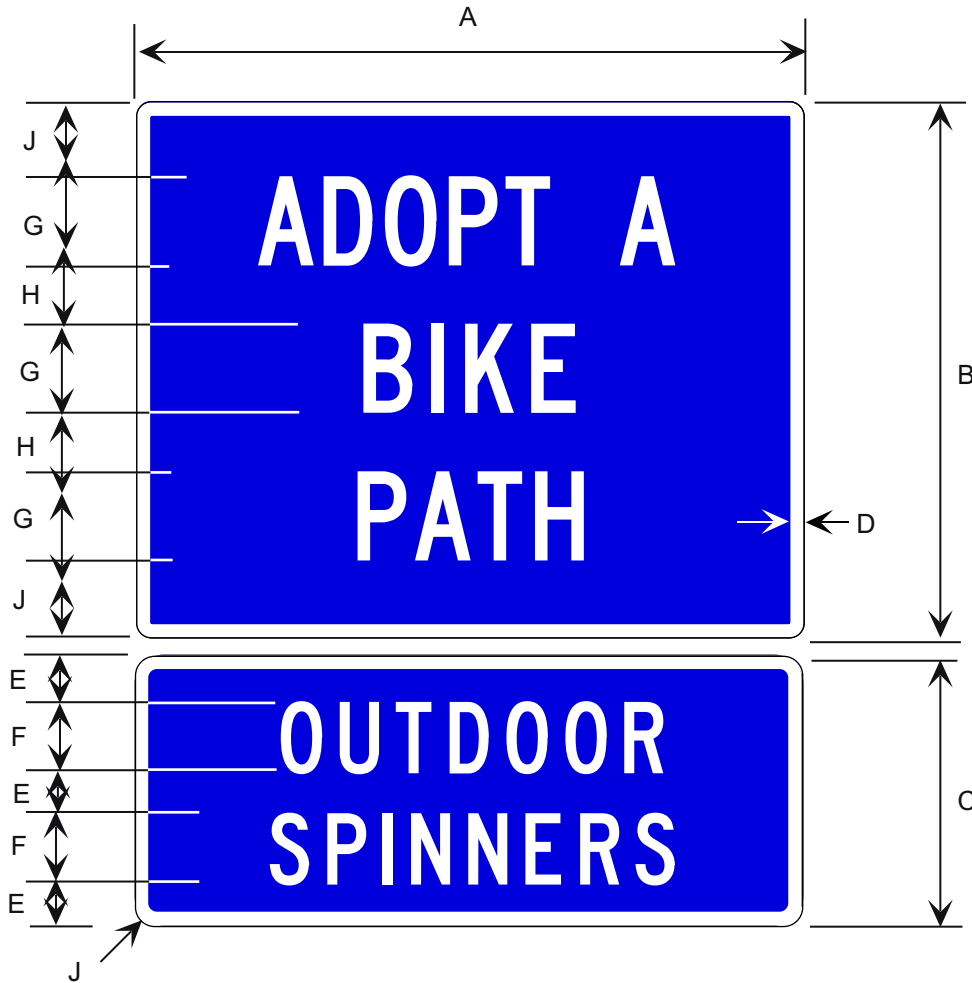

Border and Legend: White
Background: Blue

Road Class	Dimensions (inches)								
	A	B	C	D	E	F	G	H	J
Minimum	24	18	12	0.75	2	3C	3C	3.0	1.5
Conventional	30	24	12	0.75	2	3C	4C	3.5	2

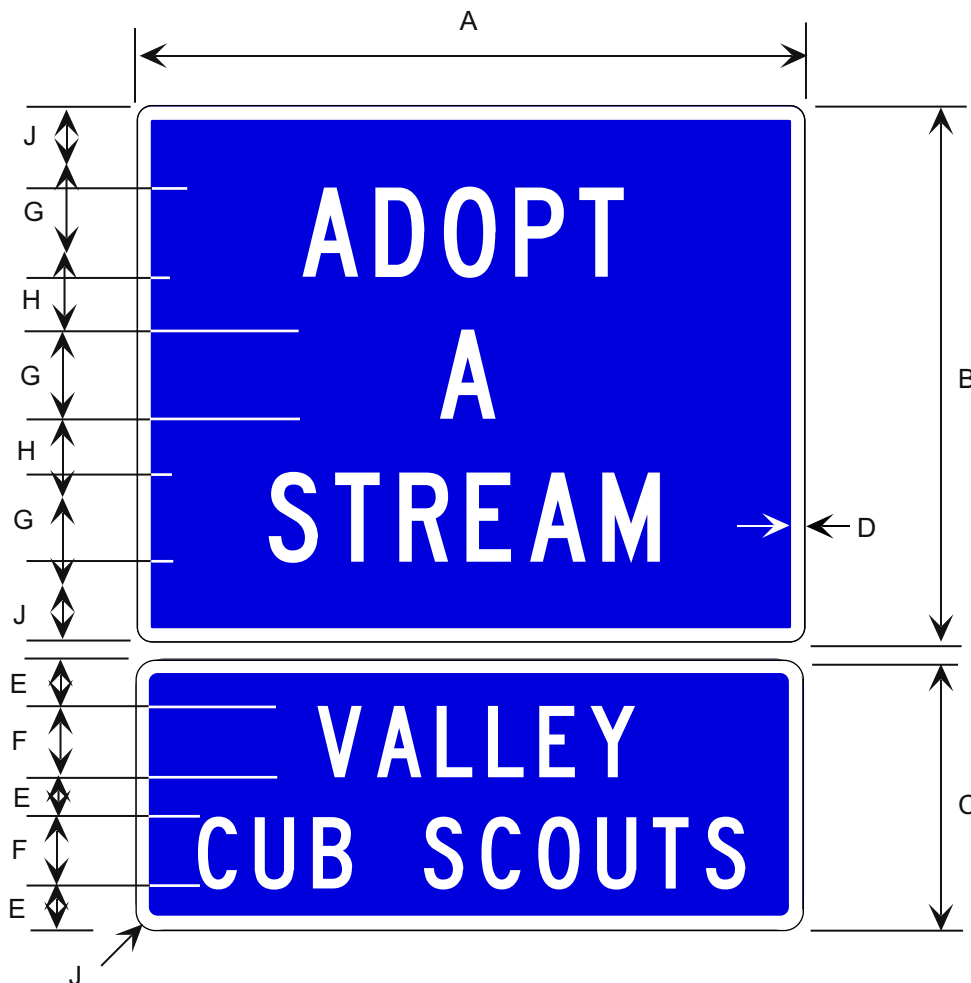

Border and Legend: White
 Background: Blue

Road Class	Dimensions (inches)								
	A	B	C	D	E	F	G	H	J
Min	24	18	12	0.75	2	3C	3C	3.0	1.5
Conv	30	24	12	0.75	2	3C	4C	3.5	2



Border and Legend: White
Background: Blue

Prior to the 2002 publication of this manual,
this sign was numbered AK-SP1-1.

Road Class	Dimensions (inches)							
	A	B	C	D	E	F	G	H
Conv & Min	30	36	1	3.5	5C	2	4E	1.88

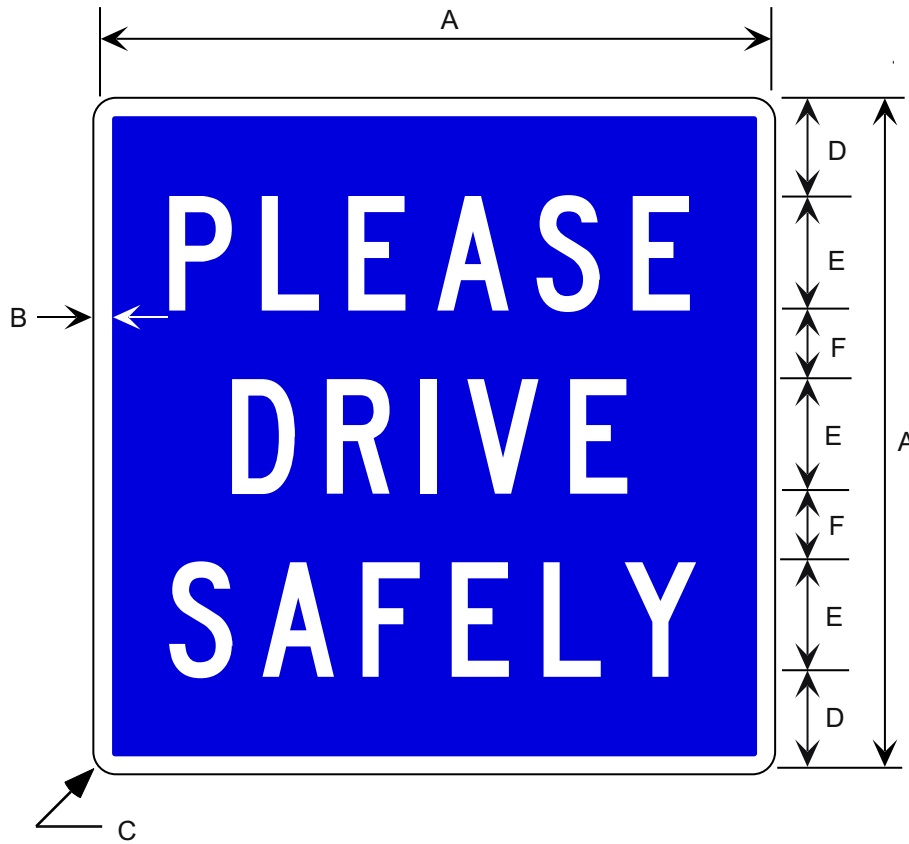

Border and Legend: White
Background: Blue

Prior to the 2002 publication of this manual,
this sign was numbered AK-SP1-2.

Road Class	Dimensions (inches)					
	A	B	C	D	E	F
Conv & Min	30	0.75	1.88	4.5	5C	3

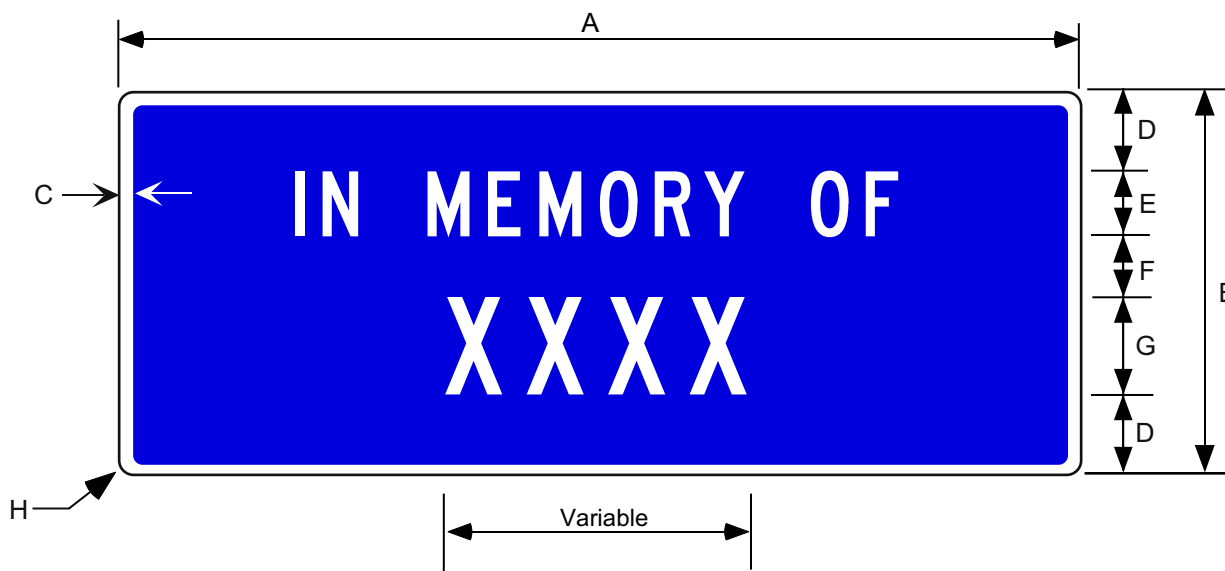

Border and Legend: White
 Background: Blue

This plaque may be used in conjunction with a "PLEASE DON'T DRINK AND DRIVE" or a "PLEASE DRIVE SAFELY" sign.

Prior to the 2002 publication of this manual, this sign was numbered AK-SP1-3.

Road Class	Dimensions (inches)							
	A	B	C	D	E	F	G	H
Conv & Min	30	12	0.75	2.5	2C	2.0	3C*	1.5

* If the name is too long to fit, letter size may be reduced to 2" Series C. A 2.5" margin shall be maintained on either side of the name.

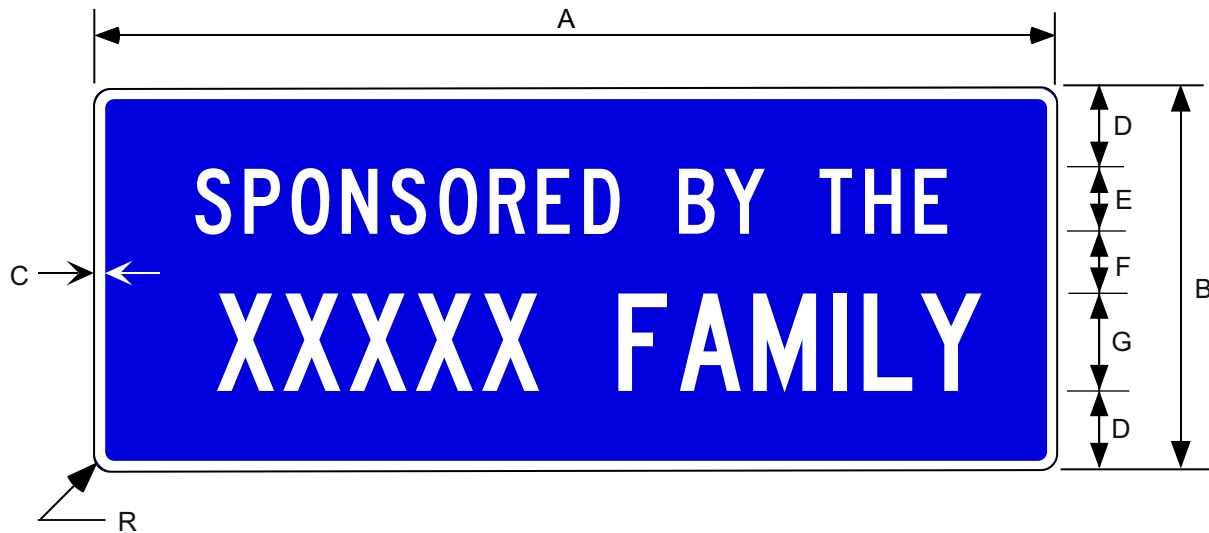

Border and Legend: White
Background: Blue

This plaque may be used in conjunction with
"PLEASE DON'T DRINK AND DRIVE" (I-160).

Prior to the 2002 publication of this manual,
this sign was numbered AK-SP1-4.

Road Class	Dimensions (inches)							
	A	B	C	D	E	F	G	R
Conv & Min	30	12	0.75	2.5	2C	2.0	3C*	1.5

* If the name is too long to fit, letter size may be reduced to 2" Series C. A 2.5" margin shall be maintained on either side of the name.

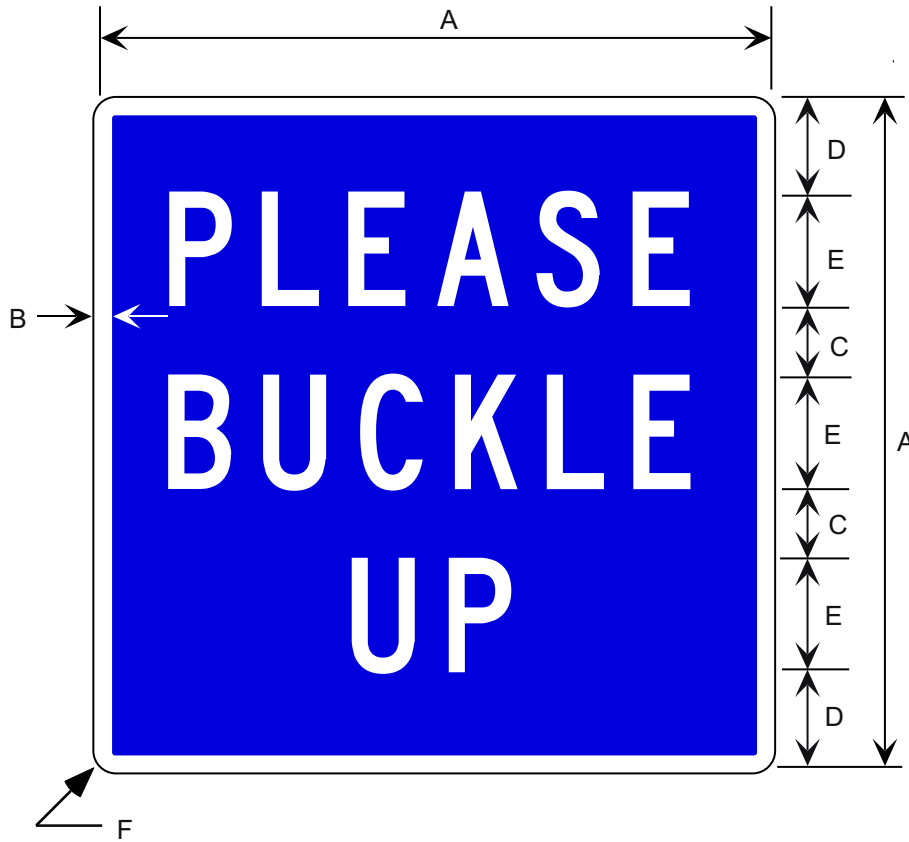

Border and Legend: White
 Background: Blue

Road Class	Dimensions (inches)					
	A	B	C	D	E	F
Conv & Min	30	0.75	3	4.5	5C	1.88



Sign graphics may be obtained in electronic form from the ADOT&PF State Traffic Engineer.

Use the following 3M Series 700 Colors or approved equivalents:
 708 Green (Two shades -100% and 50%)
 710 Blue
 722 Lemon Yellow (100% to 0% gradient)
 723 Magenta

Prior to the 2002 publication of this manual, this sign was numbered I-15B.

Make graphic and lettering proportional to those shown. Adjust as necessary to fit 24"x 30" sign size.

Road Class	Dimensions (inches)			
	A	B	C	D
Minimum	24	30	0.38	0.63
Standard	36	48	0.63	0.88

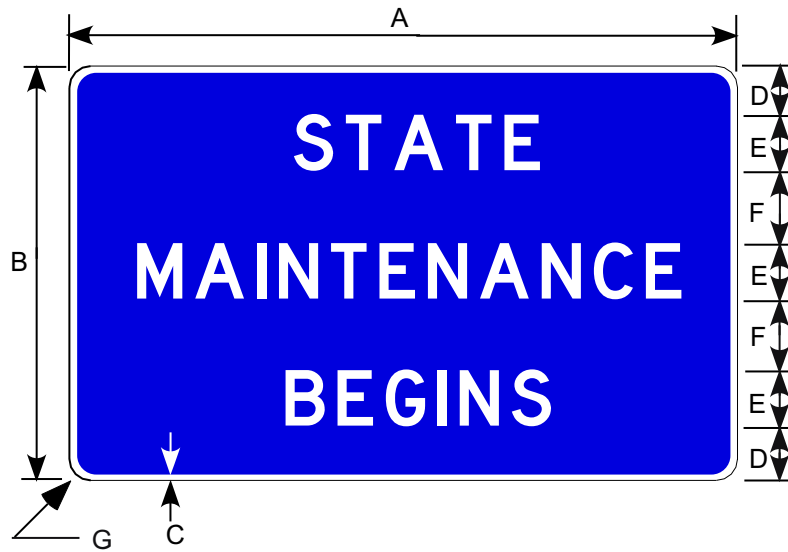

Border and Legend: White
Background: Blue

Prior to the 2002 publication of this manual,
this sign was numbered M8-1.

Road Class	Dimensions (inches)						
	A	B	C	D	E	F	G
Conv & min	30	18	0.5	2.5	3D	2	1.13

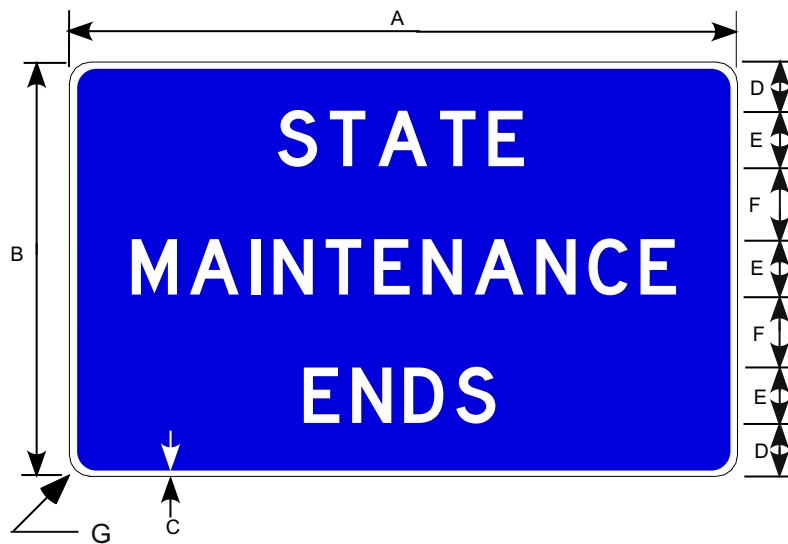

Border and Legend: White
Background: Blue

Prior to the 2002 publication of this manual,
this sign was numbered M8-2.

Road Class	Dimensions (inches)						
	A	B	C	D	E	F	G
Conv & Min	30	18	0.5	2.5	3D	2	1.13

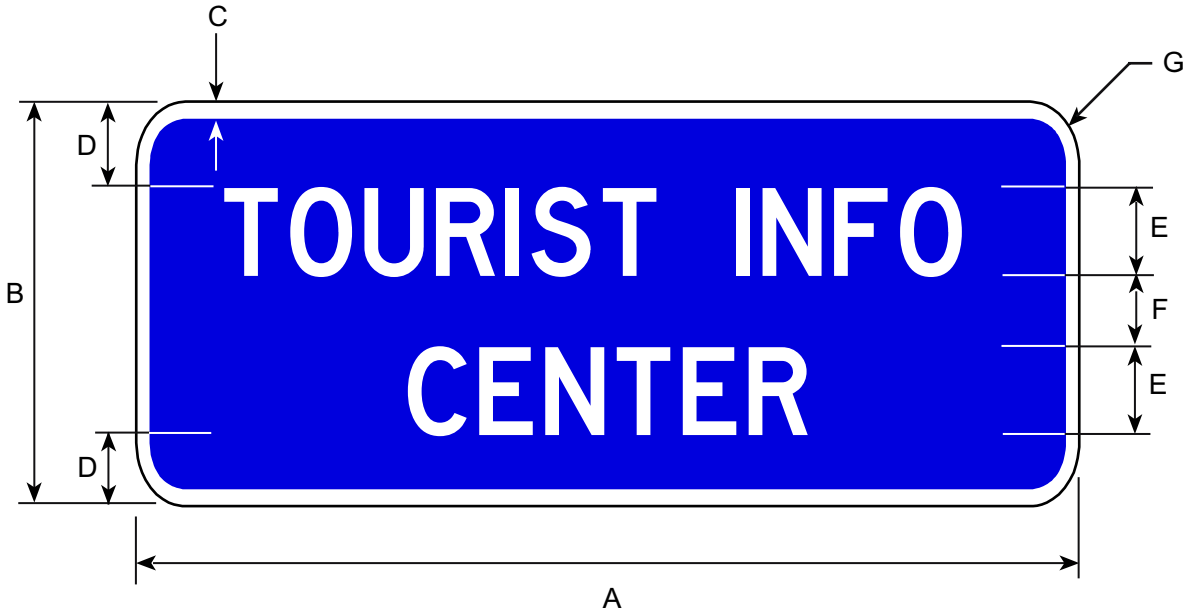

Border and Legend: White
Background: Blue

Road Class	Dimensions (inches)						
	A	B	C	D	E	F	G
Conv & Min	72	30	0.75	6	6D	6	1.88
Expressway	90	36	1.00	6	8D	8	2.25
Freeway	120	54	1.25	10	12D	10	3.25



Border and Legend: White
Background: Blue

Road	Dimensions (inches)						
Class	A	B	C	D	E	F	G
Conv & Min	72	30	0.75	6	6D	6	1.88
Expressway	90	36	1.00	6	8D	8	2.25
Freeway	120	54	1.25	10	12D	10	3.25

BUSINESS LOGO SIGNS

LG-F1x2 to LG-R1x3

LG-F1x2

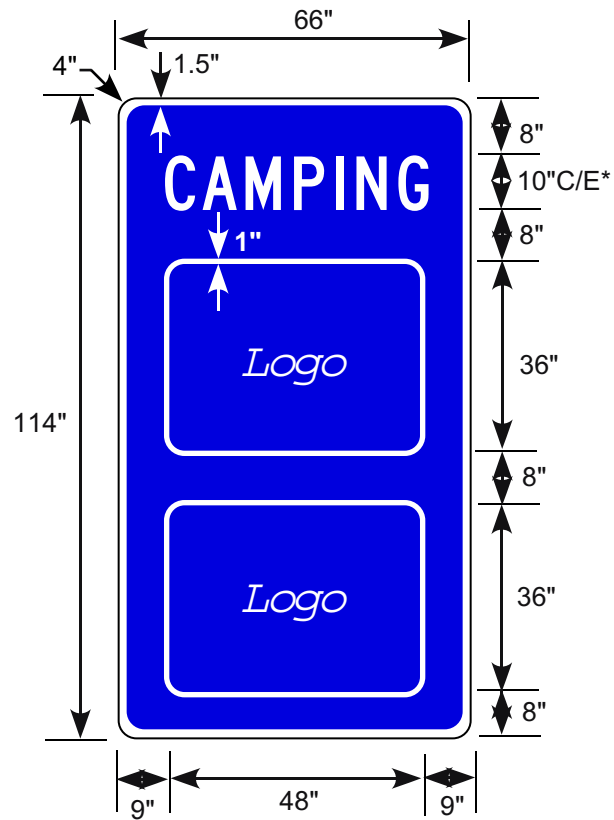

Border and Legend: White
Background: Blue

Alternative Headings:
CAMPING
FOOD
GAS
LODGING

* Use series E characters for "FOOD" and "GAS"
Use series C for "CAMPING" OR "LODGING".

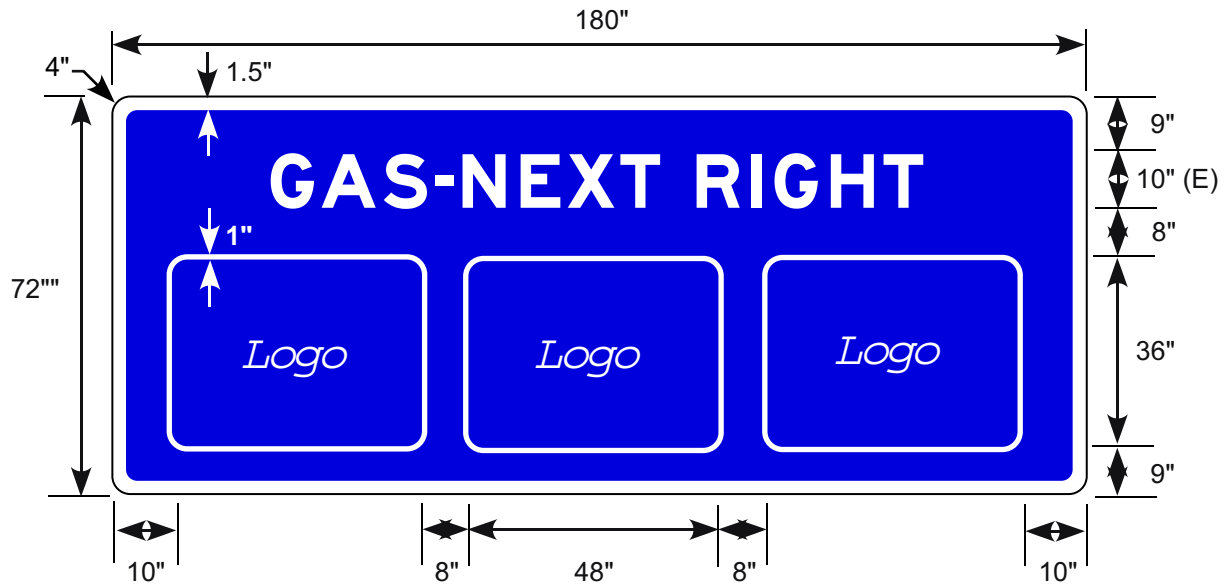

Border and Legend: White
Background: Blue

Alternative Service Types:
CAMPING
FOOD
GAS
LODGING

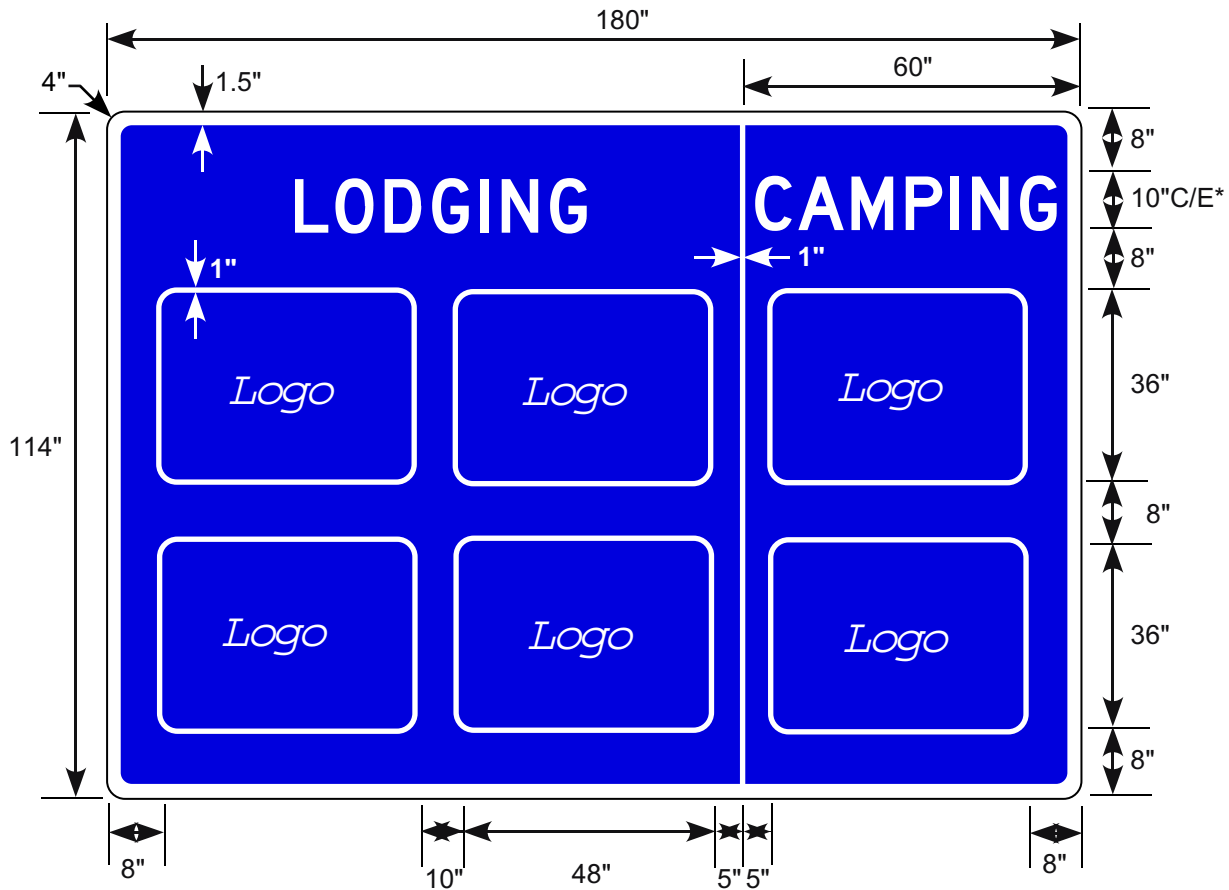

Border and Legend: White
Background: Blue

Alternative Headings:
CAMPING
FOOD
GAS
LODGING

* Use series E characters except for "CAMPING" OR "LODGING" when those words need to fit within a single column. In those cases, use series C.

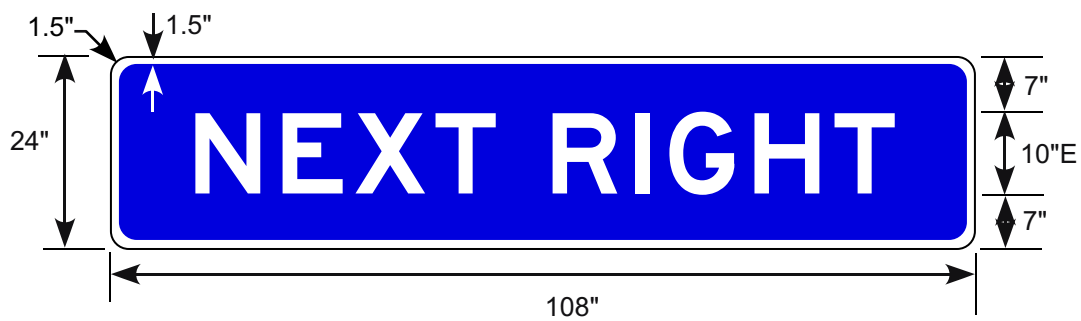

Border and Legend: White
Background: Blue

Intended to be used with 2 or 3 LG-F1x2 signs.

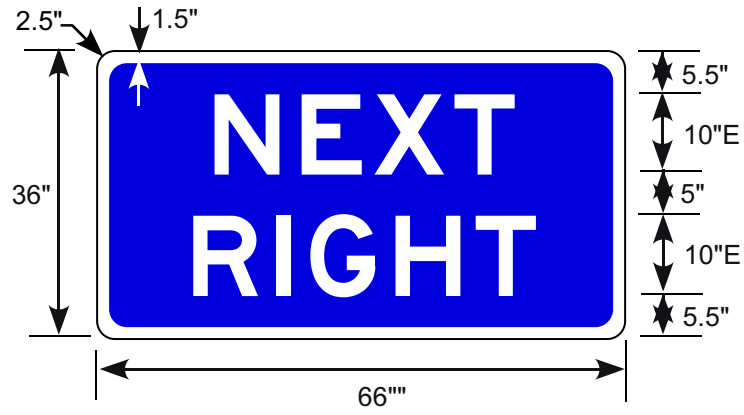

Border and Legend: White
Background: Blue

Intended to be used with one LG-F1x2 sign.

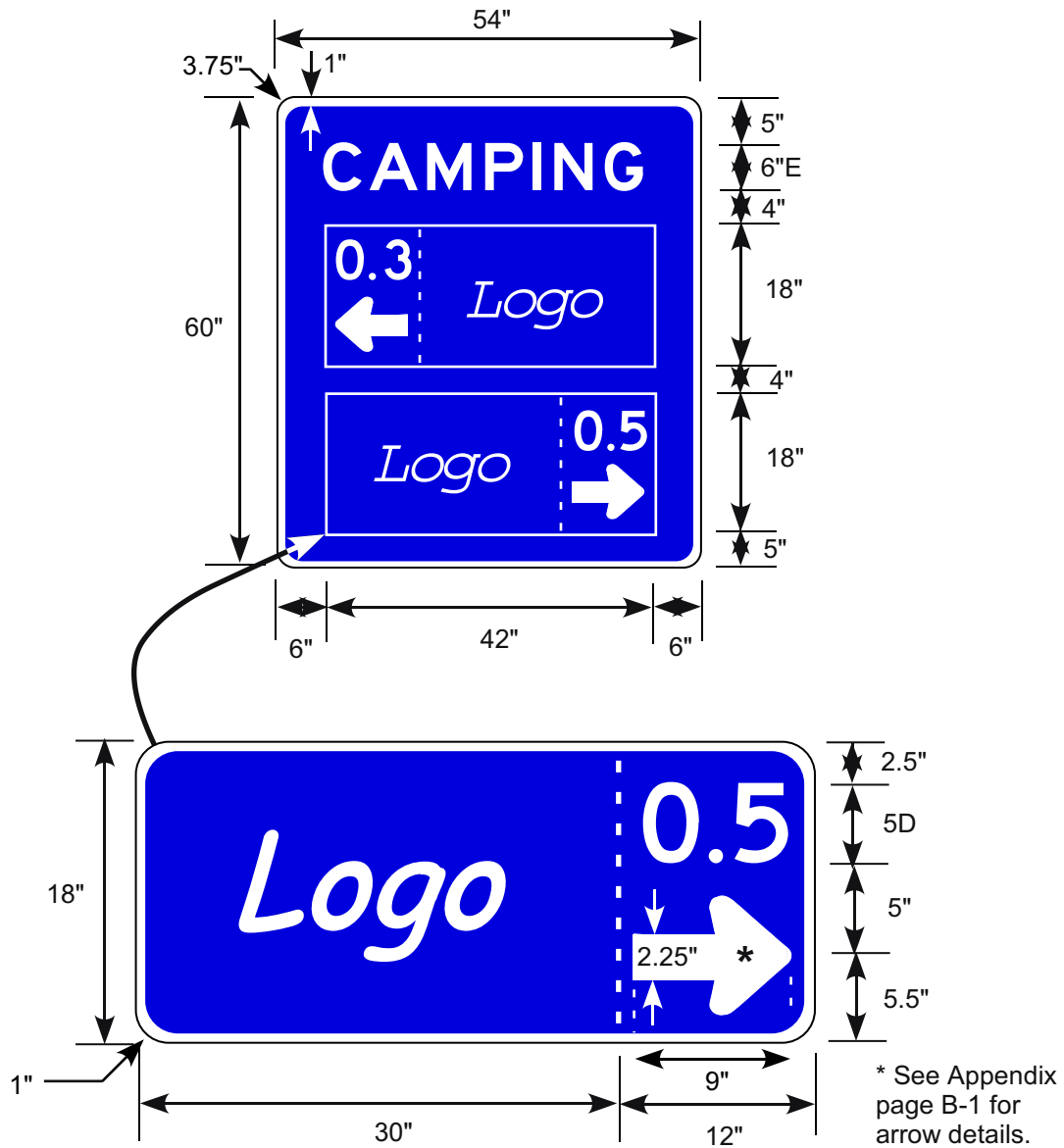

Border and Legend: White
Background: Blue

Alternative Headings:
CAMPING
FOOD
GAS
LODGING

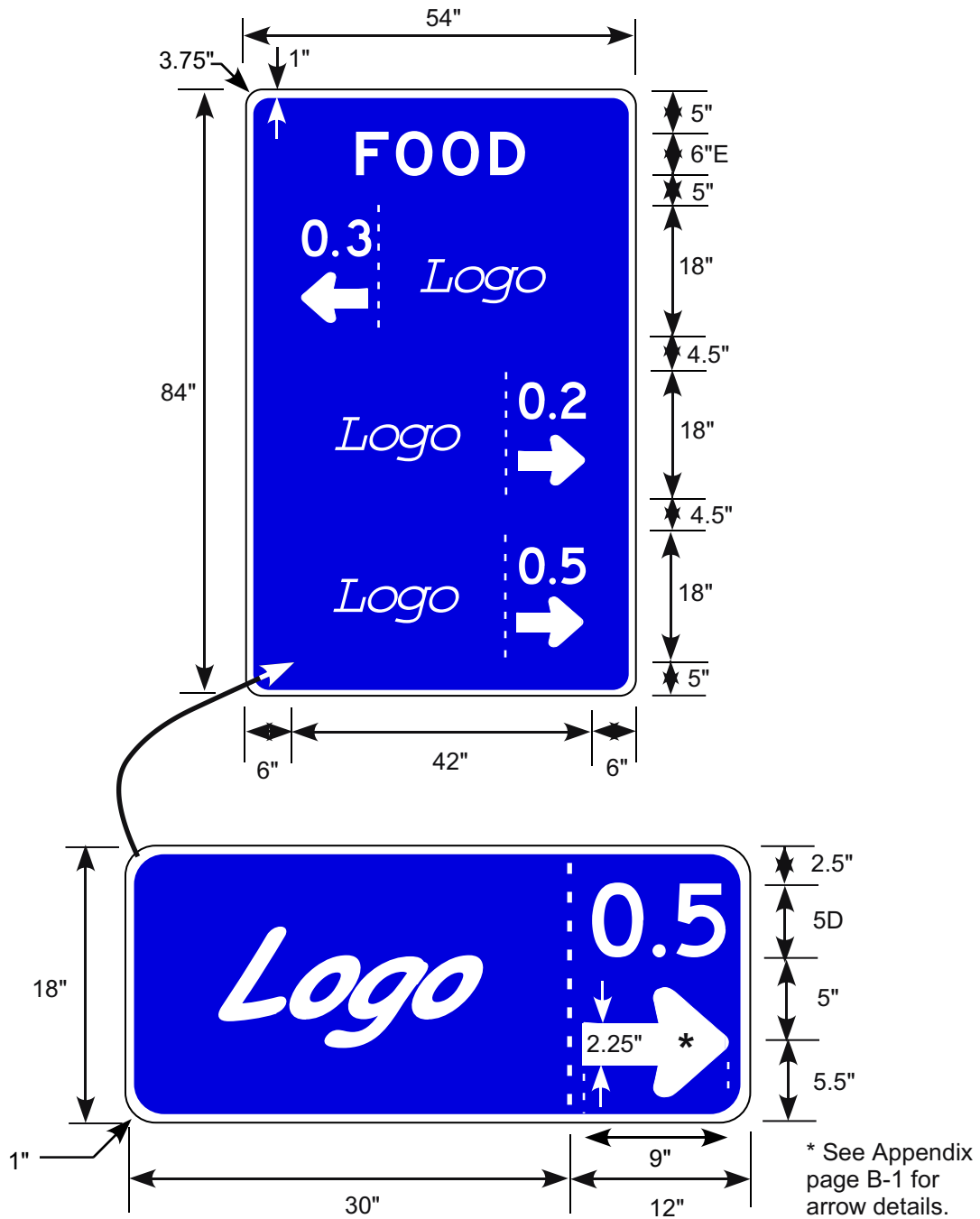

Border and Legend: White
 Background: Blue

Alternative Headings:
 CAMPING
 FOOD
 GAS
 LODGING

MARKERS

M1-2 to M12-1

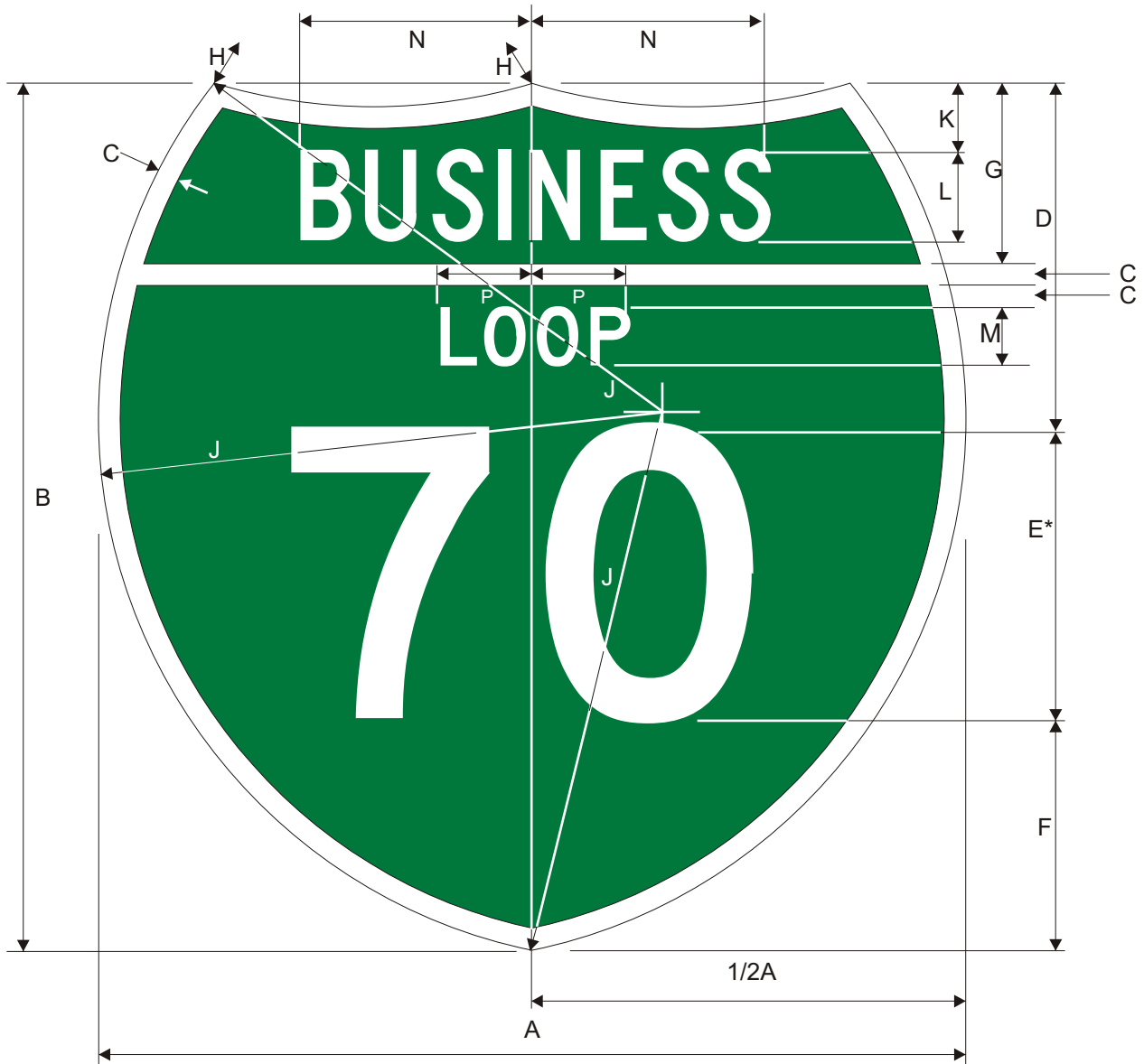

*Optically space numerals about vertical centerline.

Border and Legend: White
Background: Green

Road Class	Dimensions (inches)													
	A	B	C	D	E	F	G	H	J	K	L	M	N	P
1,2 digits	24	24	0.50	8.0	10D	6.0	5.0	15	15	2.0	2.5C	1.5D	6.63	2.5
1,2 digits	36	36	0.75	12	15D	9.0	7.5	22.5	22.5	3.0	3.75C	2.25D	9.94	3.75
1,2 digits	48	48	1.0	16	20D	12	10	30	30	4.0	5C	3D	13.25	5.0
3 digits	30	24	5.0	8.0	10D	6.0	5.0	24	17	2.0	2.5C	1.5D	6.63	2.5
3 digits	45	36	0.75	12	15D	9.0	7.5	36	25.5	3.0	3.75C	2.25D	9.94	3.8
3 digits	60	48	1.0	16	20D	12	10	48	34	4.0	5C	3D	13.25	5.0

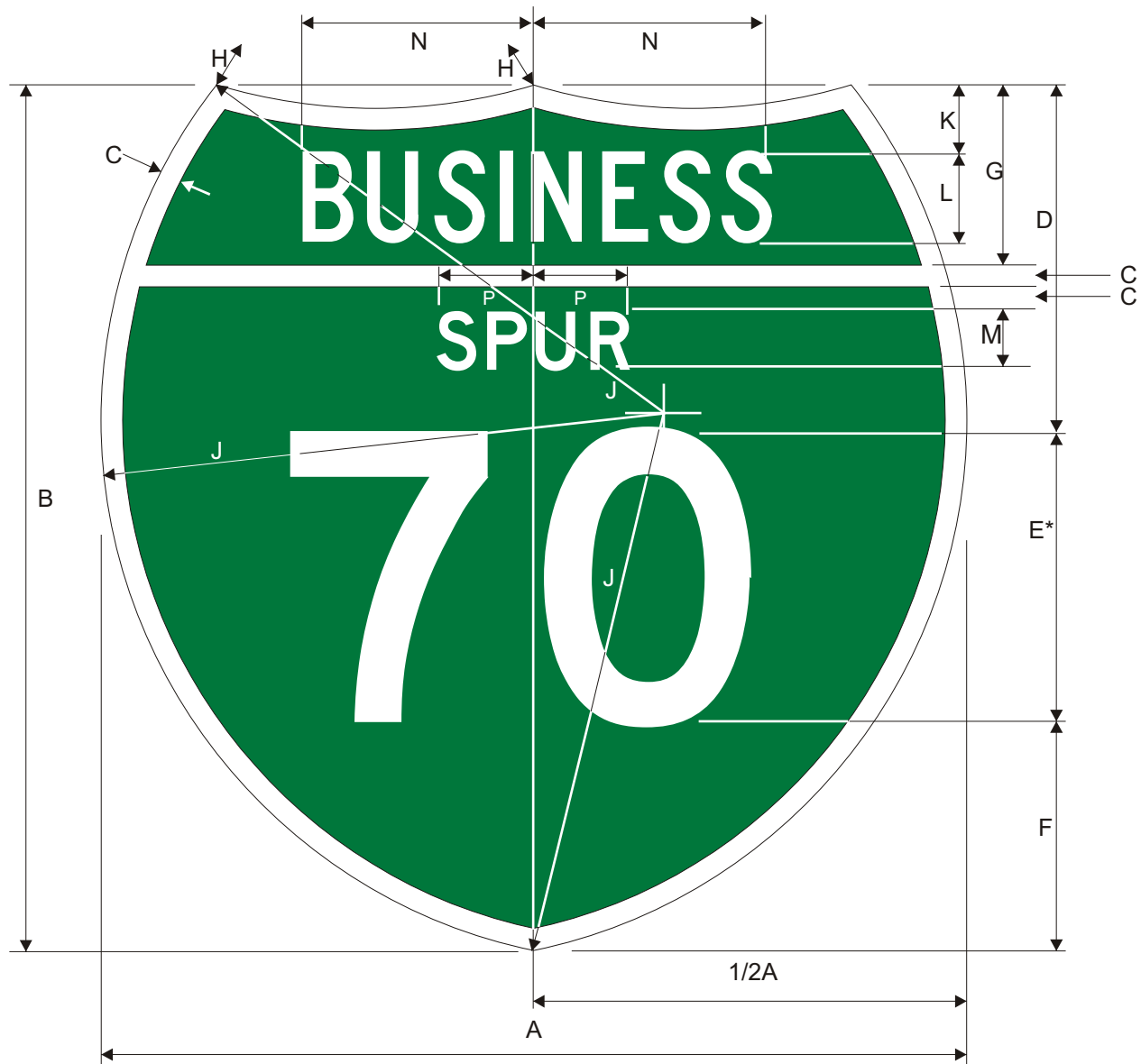

*Optically space numerals about vertical centerline.

Border and Legend: White
Background: Green

Road Class	Dimensions (inches)													
	A	B	C	D	E	F	G	H	J	K	L	M	N	P
1,2 digits	24	24	0.50	8	10D	6	5.0	15.0	15.0	2.0	2.5C	1.5D	6.63	2.56
1,2 digits	36	36	0.75	12	15D	9	7.5	22.5	22.5	3.0	3.75C	2.25D	9.94	3.84
1,2 digits	48	48	1	16	20D	12	10	30	30	4.0	5C	3D	13.25	5.13
3 digits	30	24	5	8	10D	6	5.0	24.0	17.0	2.0	2.5C	1.5D	6.63	2.56
3 digits	45	36	0.75	12	15D	9	7.5	36.0	25.5	3.0	3.75C	2.25D	9.94	3.84
3 digits	60	48	1	16	20D	12	10.0	48.0	34.0	4.0	5C	3D	13.25	5.13

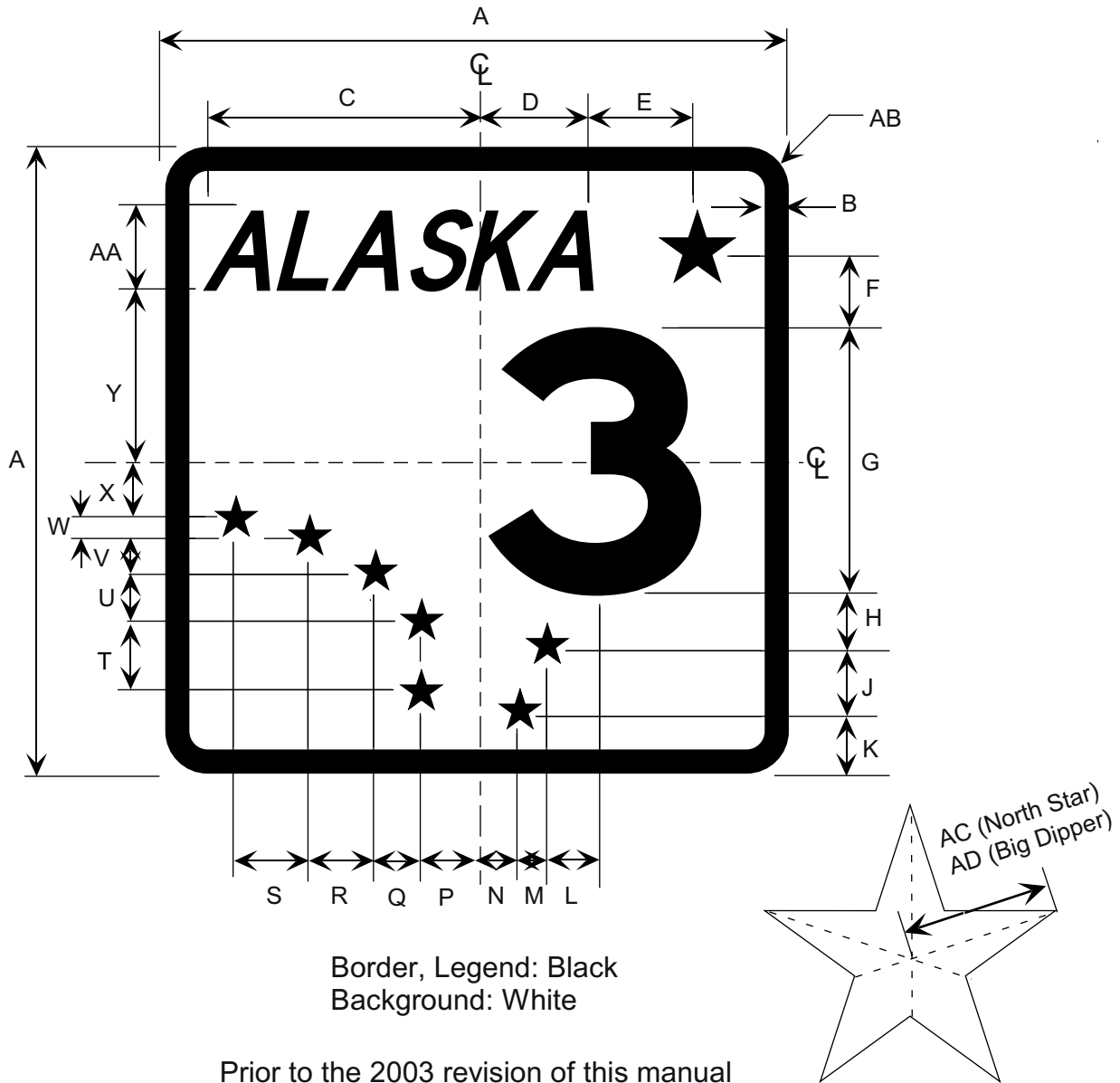

Border, Legend: Black
Background: White

Prior to the 2003 revision of this manual
this sign was numbered M1-6.

Note: When used as an inset in a larger sign, this plate may be reduced to 18"x18" when design considerations necessitate minimizing sign size.

Road Class	Dimensions (inches)													
	A	B	C	D	E	F	G	H	J	K	L	M	N	P
Minimum	24	0.75	10.13	4.13	4.31	3	10E	1.5	2.50	3.0	1.50	1.0	1.88	1.88
Conventional	36	1.00	16.00	6.25	6.50	4	16E	1.75	3.75	4.5	2.25	1.5	2.81	2.81
	Q	R	S	T	U	V	W	X	Y	AA	AB	AC	AD	
	1.75	2.56	2.88	2.69	1.63	1.31	0.69	2.13	6.50	3.0	1.5	1.50	0.94	
	2.63	3.88	4.31	4.00	2.44	1.94	1.06	3.06	9.75	4.5	1.5	2.25	1.38	



*Optically space numerals about vertical centerline.

Border and Legend: White
Background: Brown

Road Class	Dimensions (inches)								
	A	B	C	D	E	F	G	H	J
Minimum	12.75	18	0.5	2.63	6D	1.13	4	1.61	2.0
Conventional	17.00	24	0.5	3.50	8D	1.75	5	2.25	2.5

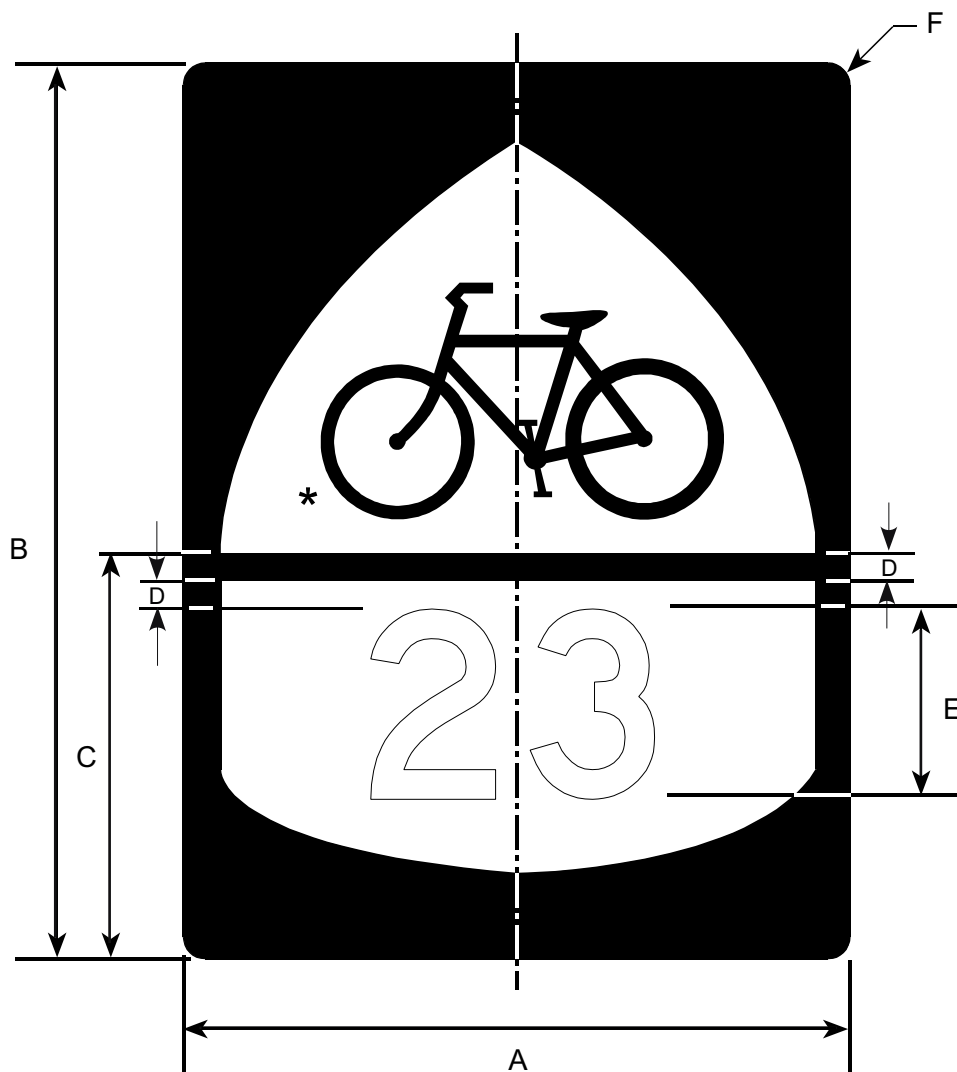

*Make symbol proportional to the graphic shown.

Legend: Black
 Inner Background: White
 Outer Background: Black

Route number is variable.

Road Class	Dimensions (inches)					
	A	B	C	D	E	F
Min & Conv	18	24	10.75	0.5	5D	1.5

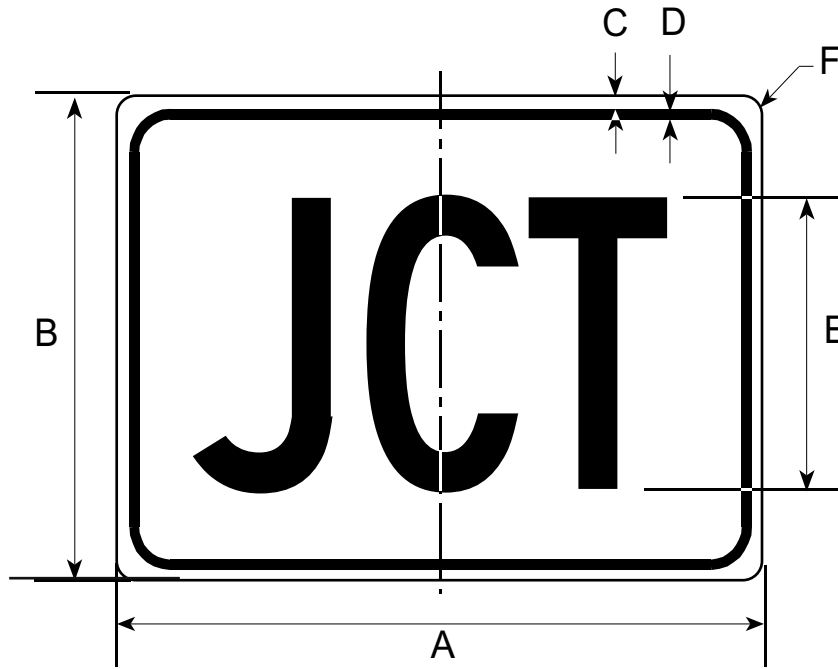

Border and Legend: Black
Background: White

Road Class	Dimensions (inches)					
	A	B	C	D	E	F
Minimum	21	15	0.38	0.63	9C	1.5

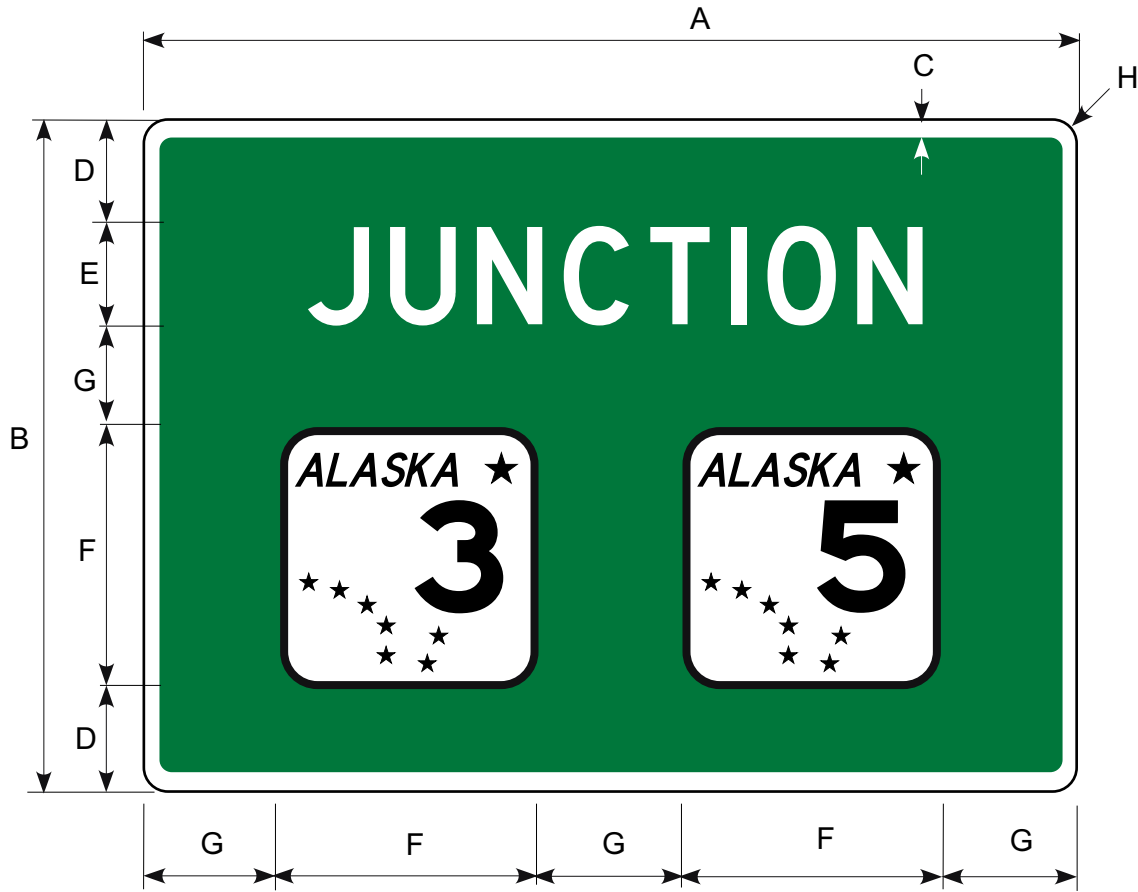

Legend: White
 Background: Green
 Route Plaque: Black on White

Make symbol proportional to the graphic shown.

Road Class	Dimensions (inches)							
	A	B	C	D	E	F	G	H
Expwy/Fwy	72	60	1.5	9.0	10C	24	8.0	3.75

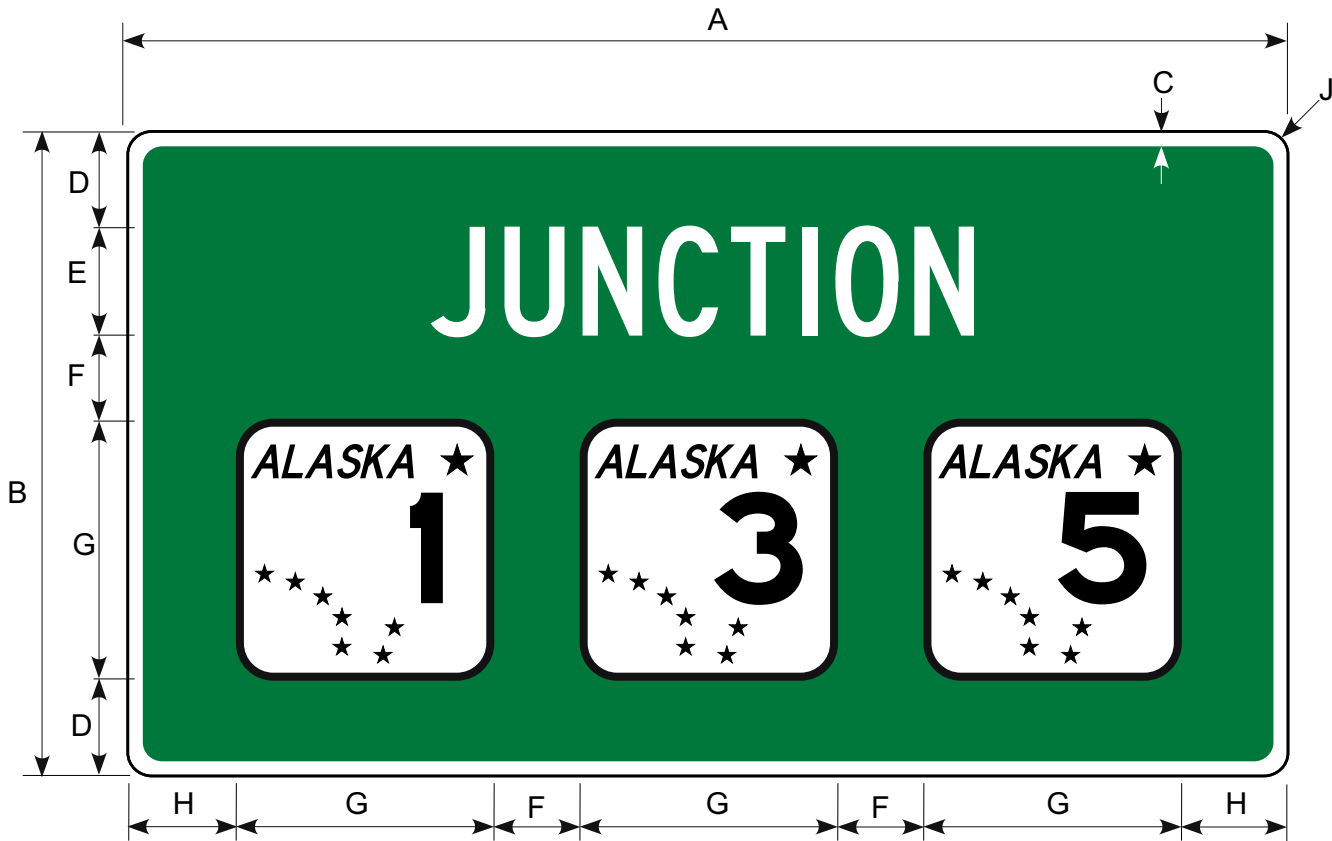

Legend: White
 Background: Green
 Route Plaque: Black on White

Make symbol proportional
 to graphic shown.

Road Class	Dimensions (inches)								
	A	B	C	D	E	F	G	H	J
Expwy/Fwy	108	60	1.50	9	10C	8	24	10	3.75

M3-1

M3-2

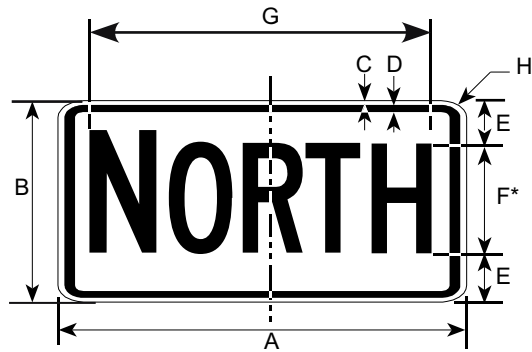

M3-1

* Make first letter 10% larger.

Road Class	Dimensions (inches)							
	A	B	C	D	E	F	G	H
Minimum	24	12	0.38	0.63	3.0	6C	19.38	1.5
Conventional	30	15	0.50	0.75	3.5	8C	24.80	1.88

Border and Legend: Black
Background: White

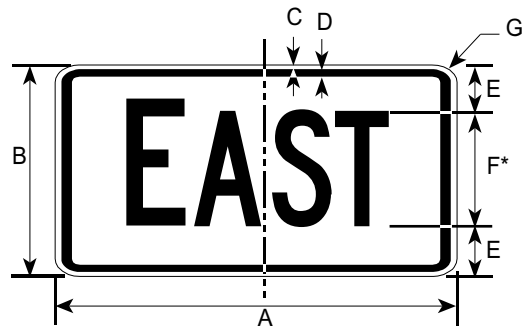

M3-2

* Make first letter 10% larger.

Road Class	Dimensions (inches)						
	A	B	C	D	E	F	G
Minimum	24	12	0.38	0.63	3.0	6C	1.5
Conventional	30	15	0.50	0.75	3.5	8C	1.88

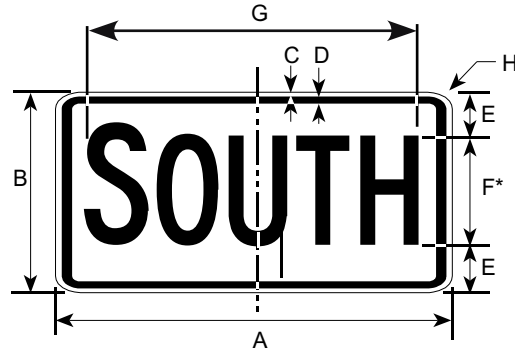

M3-3

*Make first letter 10% larger.

Road Class	Dimensions (inches)							
	A	B	C	D	E	F	G	H
Minimum	24	12	0.38	0.63	3.0	6C	19.19	1.5
Conventional	30	15	0.50	0.75	3.5	8C	24.59	1.88

Border and Legend: Black
Background: White

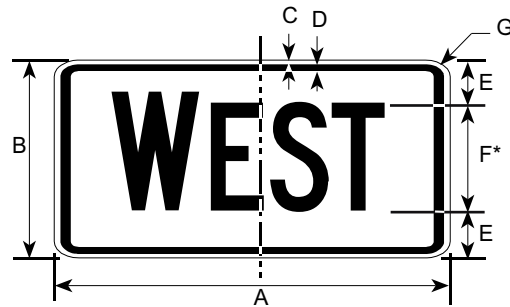

M3-4

*Make first letter 10% larger.

Road Class	Dimensions (inches)						
	A	B	C	D	E	F	G
Minimum	24	12	0.38	0.63	3.0	6C	1.5
Conventional	30	15	0.50	0.75	3.5	8C	1.88

M4-1
M4-1A
M4-2
M4-3

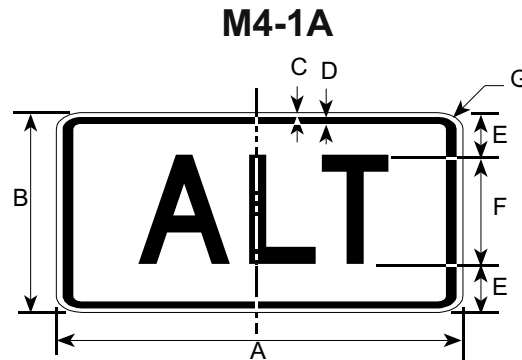
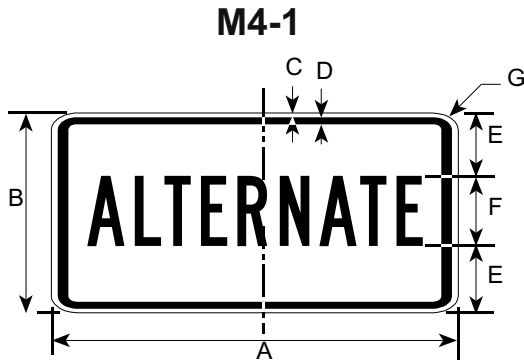

Road Class	Dimensions (inches)						
	A	B	C	D	E	F	G
Minimum	24	12	0.38	0.63	4.0	4B	1.5
Conventional	30	15	0.38	0.63	4.5	6B	1.5

Dimensions (inches)							
A	B	C	D	E	F	G	
24	12	0.38	0.63	3.0	6C	1.5	
30	15	0.38	0.63	3.5	8C	1.5	

Border and Legend: Black
 Background: White

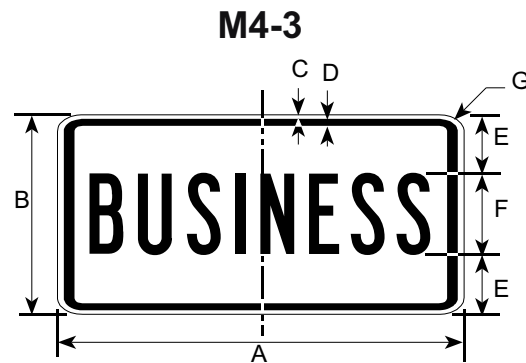
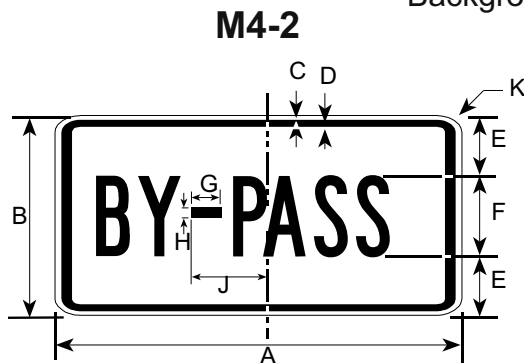

Road Class	Dimensions (inches)									
	A	B	C	D	E	F	G	H	J	K
Minimum	24	12	0.38	0.63	3.5	5B	0.75	0.63	3.38	1.5
Conventional	30	15	0.38	0.63	4.0	7B	1.0	0.88	3.88	1.5

Dimensions (inches)							
A	B	C	D	E	F	G	
24	12	0.38	0.63	3.5	5B	1.5	
30	15	0.38	0.63	4.0	7B	1.5	

M4-4
M4-5
M4-6

M4-4

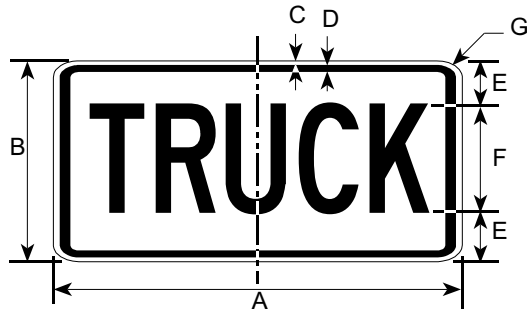

M4-6

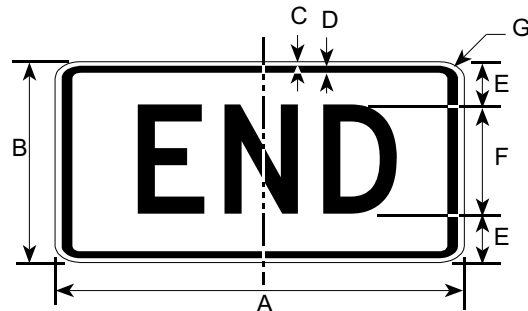

Road Class	Dimensions (inches)						
	A	B	C	D	E	F	G
Minimum	24	12	0.38	0.63	3.0	6C	1.5
Conventional	30	15	0.38	0.63	3.5	8C	1.5

Road Class	Dimensions (inches)						
	A	B	C	D	E	F	G
Minimum	24	12	0.38	0.63	3.0	6D	1.5
Conventional	30	15	0.38	0.63	3.5	8D	1.5

Border and Legend: Black
 Background: White

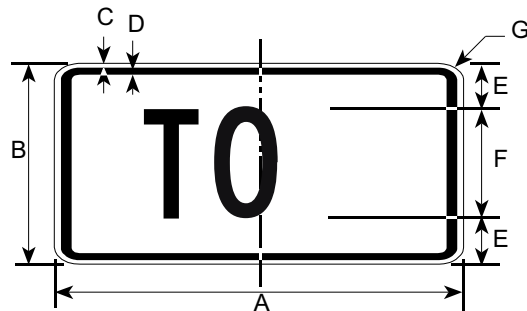

M4-5

Road Class	Dimensions (inches)						
	A	B	C	D	E	F	G
Minimum	24	12	0.38	0.63	3.0	6E	1.5
Conventional	30	15	0.38	0.63	3.5	8E	1.5

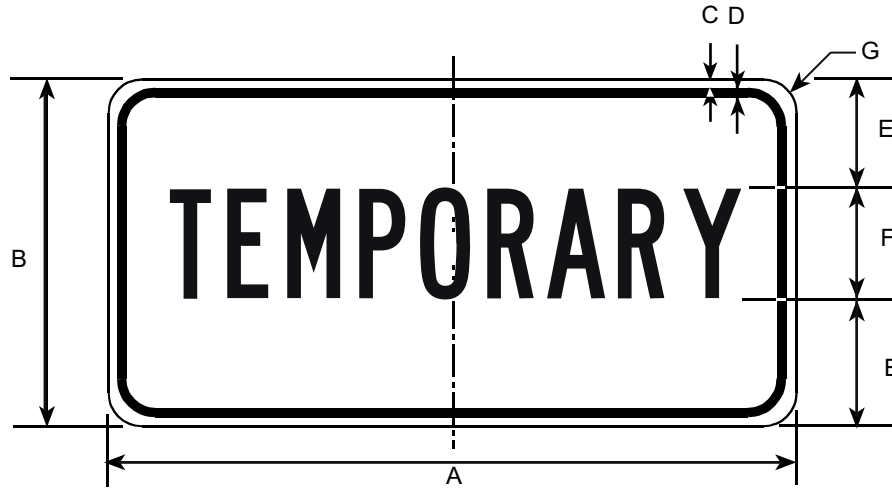

Border and Legend: Black
Background: White

Road Class	Dimensions (inches)						
	A	B	C	D	E	F	G
Minimum	24	12	0.38	0.63	4	4B	1.5
Conventional	30	15	0.38	0.63	5	5B	1.5

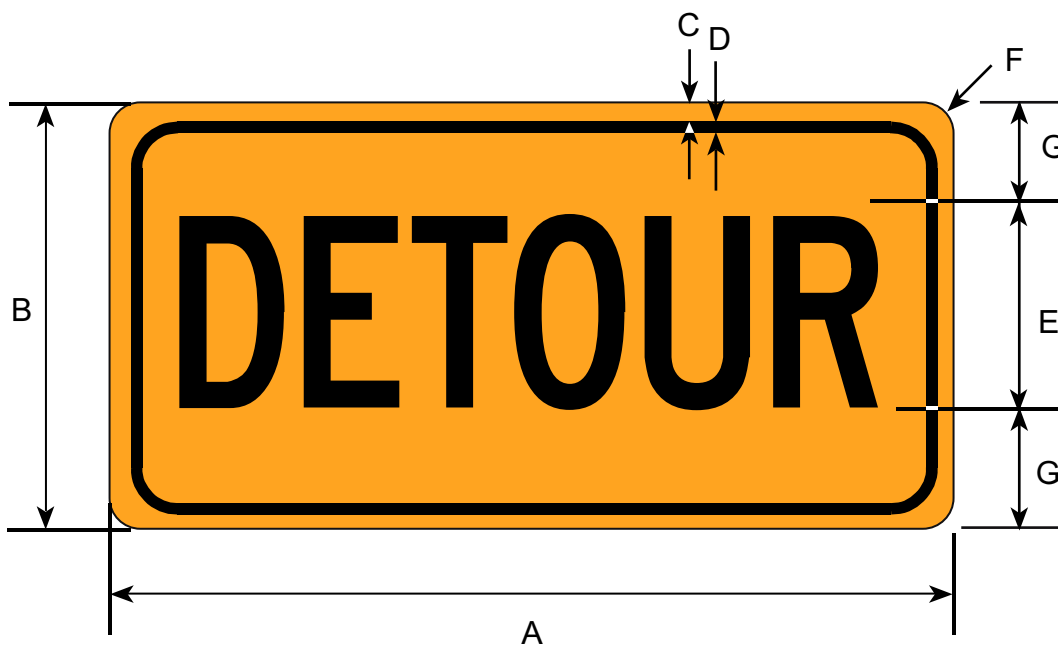

Border and Legend: Black
 Background: Orange

Road Class	Dimensions (inches)						
	A	B	C	D	E	F	G
Conv & Min	24	12	0.38	0.63	6B	1.5	3.0
Expwy/Fwy	30	15	0.38	0.63	8B	1.5	3.5

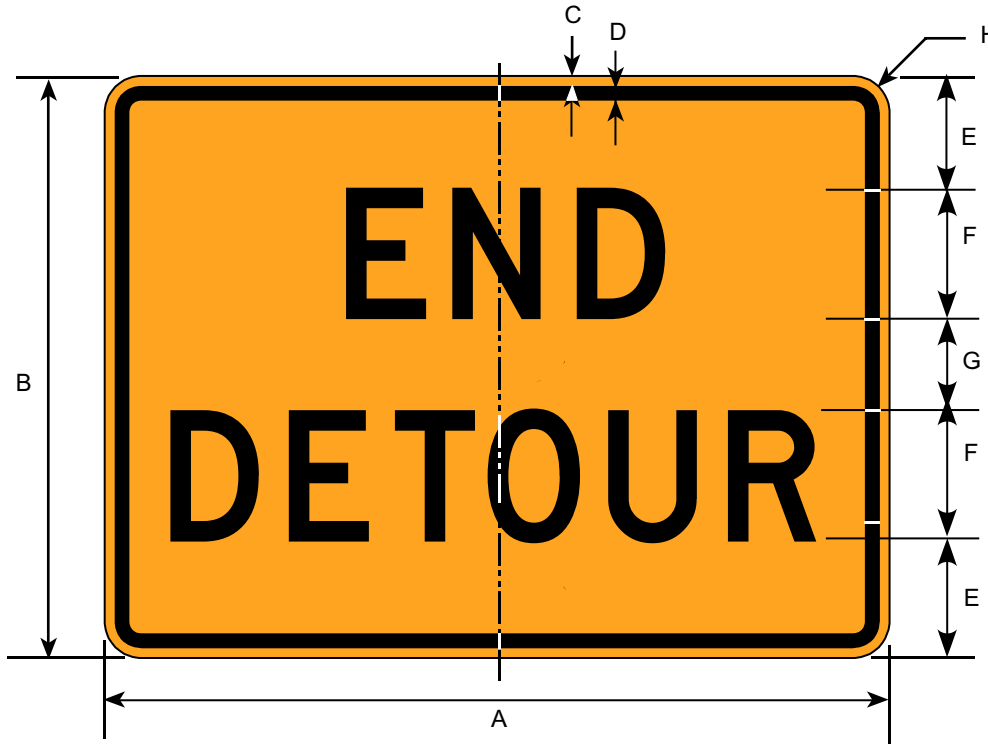

Border and Legend: Black
Background: Orange

Road Class	Dimensions (inches)							
	A	B	C	D	E	F	G	H
Conv & Min	24	18	0.38	0.63	3.5	4D	3	1.5
Expwy/Fwy	30	24	0.63	0.88	4.5	6D	3	1.5

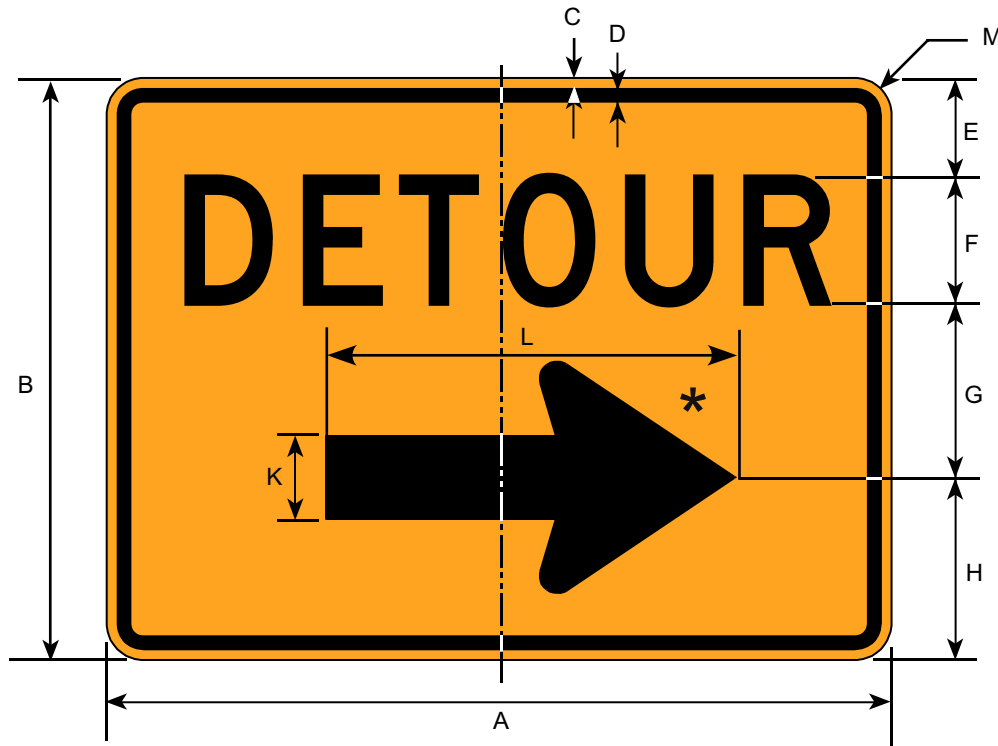

Border and Legend: Black
Background: Orange

* See Appendix B-1 for Standard Arrow Details.

Road Class	Dimensions (inches)										
	A	B	C	D	E	F	G	H	K	L	M
Minimum	30	24	0.38	0.63	4.0	5D	7.0	8.0	4.5	18	1.5
Conventional	48	36	0.63	0.88	6.0	8D	10	12	7.0	27	2.25
Expressway	60	48	0.75	1.25	8.0	10D	14	16	9.0	36	3.0

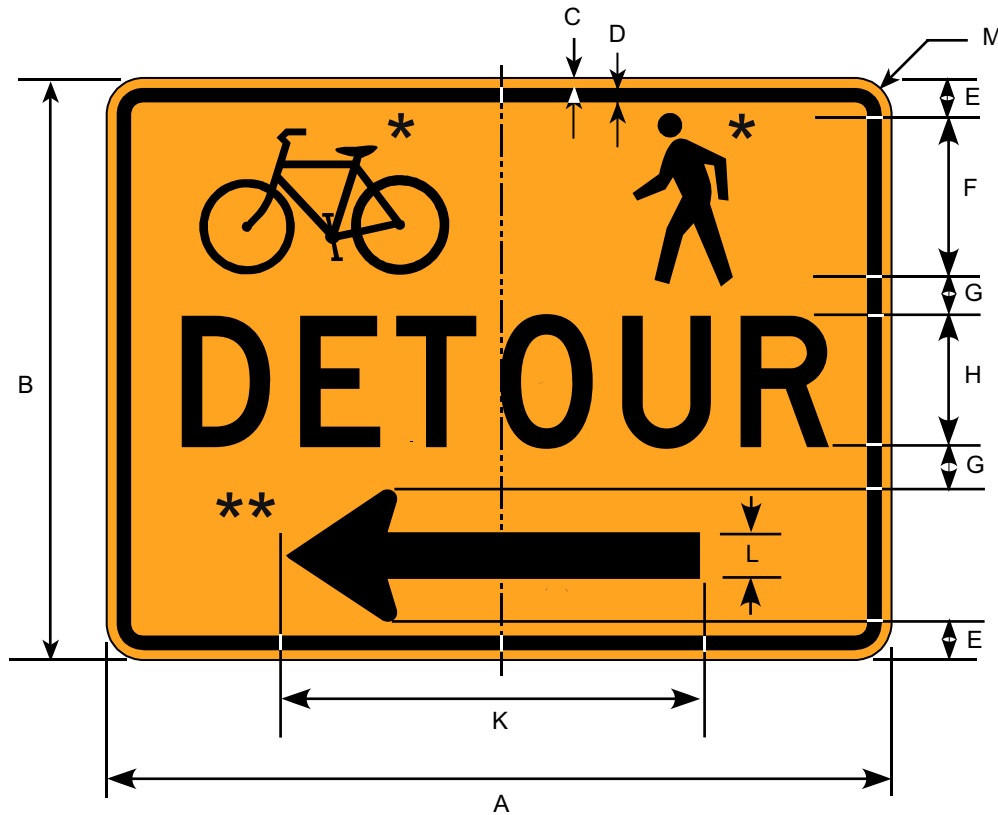

Border and Legend: Black
Background: Orange

*Make symbols proportional to the graphic shown.

** See Appendix B-1 for Standard Arrow Details.

Road Class	Dimensions (inches)										
	A	B	C	D	E	F	G	H	K	L	M
Bike (Ped)	30	24	0.38	0.63	2.0	5.0	2.5	5D	16	1.25	1.5

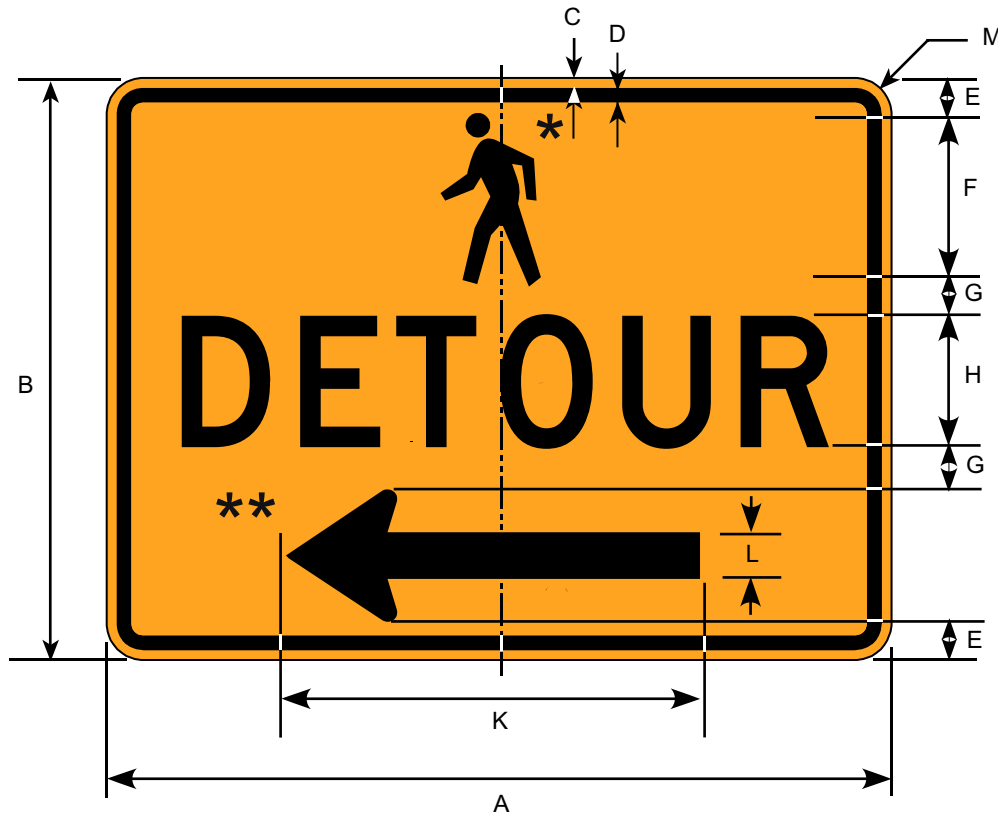

Border and Legend: Black
Background: Orange

*Make symbol proportional
to the graphic shown.

** See Appendix B-1 for Standard Arrow Details.

Road Class	Dimensions (inches)										
	A	B	C	D	E	F	G	H	K	L	M
Pedestrian Only	30	24	0.38	0.63	2.0	5.0	2.5	5D	16	1.25	1.5

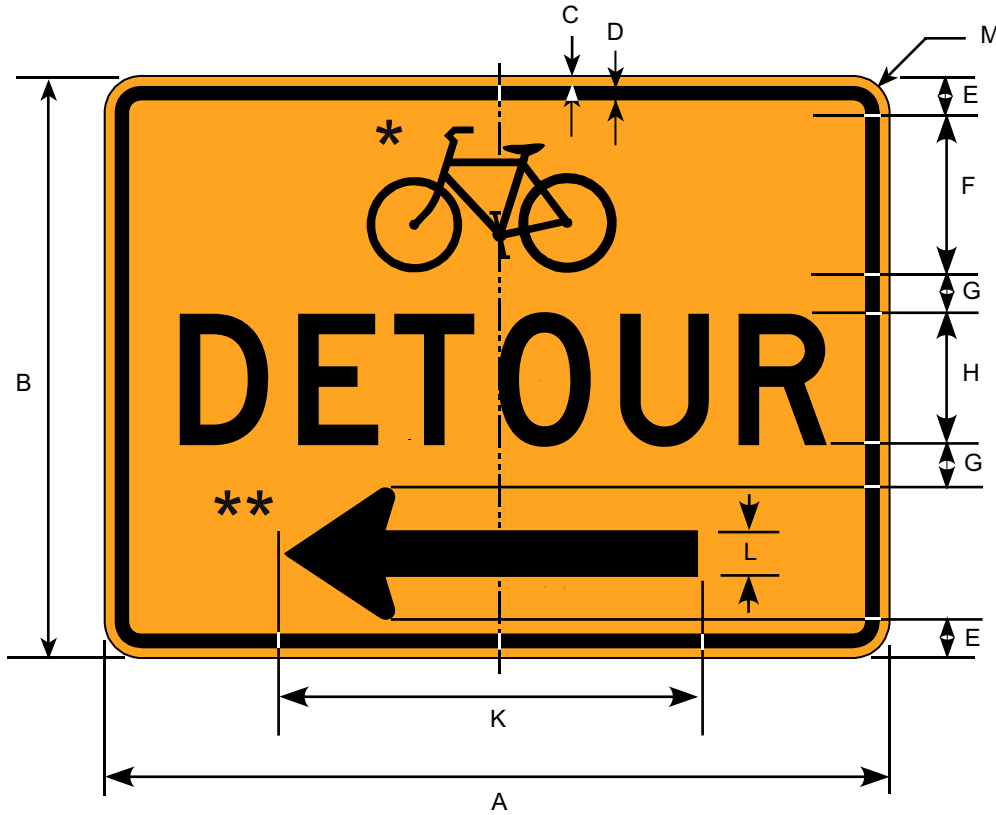

Border and Legend: Black
Background: Orange

*Make symbol proportional
to the graphic shown.

** See Appendix B-1 for Standard Arrow Details.

Road Class	Dimensions (inches)										
	A	B	C	D	E	F	G	H	K	L	M
Bike	30	24	0.38	0.63	2.0	5.0	2.5	5D	16	1.25	1.5

M4-10

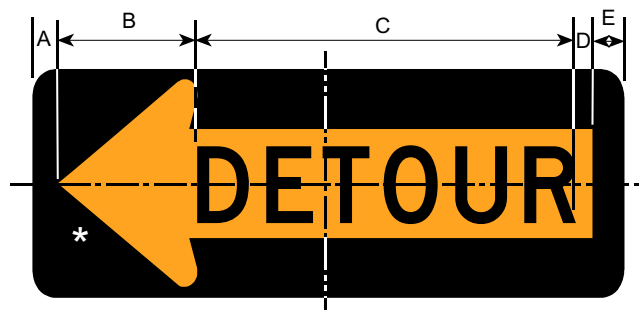

M4-10L

Road Class	Dimensions (inches)				
	A	B	C	D	E
Conv & Min	2.75	12.5	27.75	2.0	3.0

Legend and Background: Black
Arrow: Orange

* See Appendix B-1 for Standard Arrow Details.

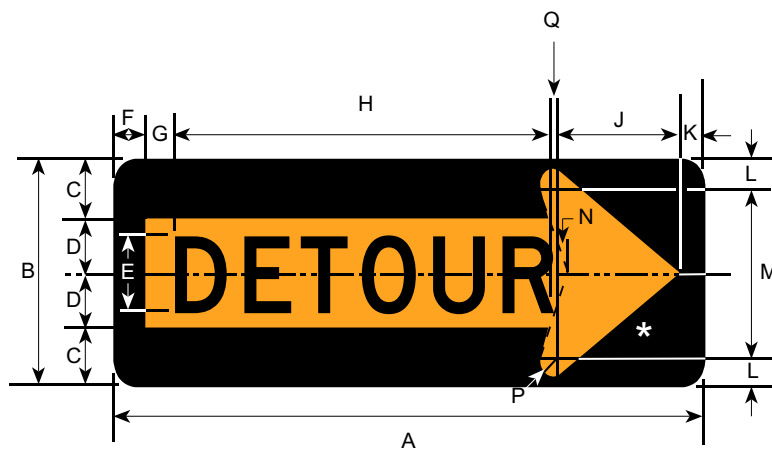

M4-10R

Road Class	Dimensions (inches)															
	A	B	C	D	E	F	G	H	J	K	L	M	N	P	Q	
Conv & Min	48	18	4.88	4.12	6D	3.0	2.0	27.75	12	2.75	2.25	13.5	0.75	1.25	0.50	

M4-100
M4-101
M4-102

M4-100



Road Class	Dimensions (inches)					
	A	B	C	D	E	F
Bike	12	4.0	0.25	1.0	2C	0.75
Conv & Min	24	6.0	0.50	1.0	4C	1.50

Border and Legend: White or Black
 Background: Green or White

M4-101

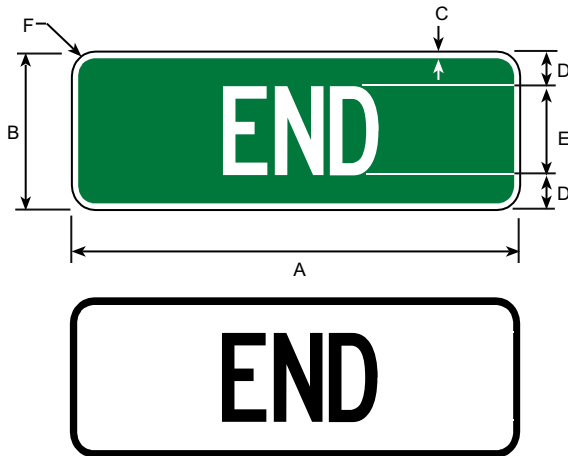

M4-102

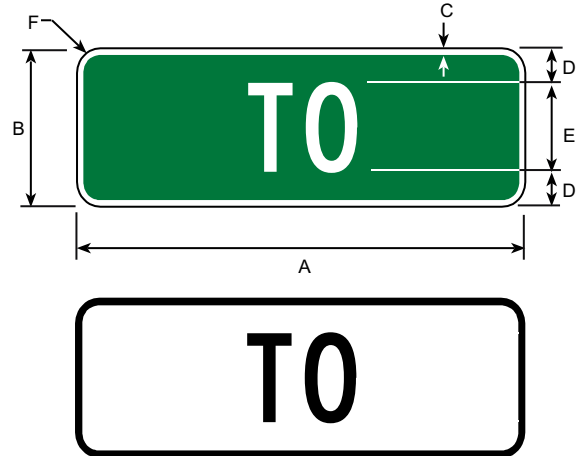

Road Class	Dimensions (inches)					
	A	B	C	D	E	F
Bike	12	4.0	0.25	1.0	2C	0.75
Conv & Min	24	6.0	0.50	1.0	4C	1.50

Road Class	Dimensions (inches)					
	A	B	C	D	E	F
Bike	12	4.0	0.25	1.0	2C	0.75
Conv & Min	24	6.0	0.50	1.0	4C	1.50

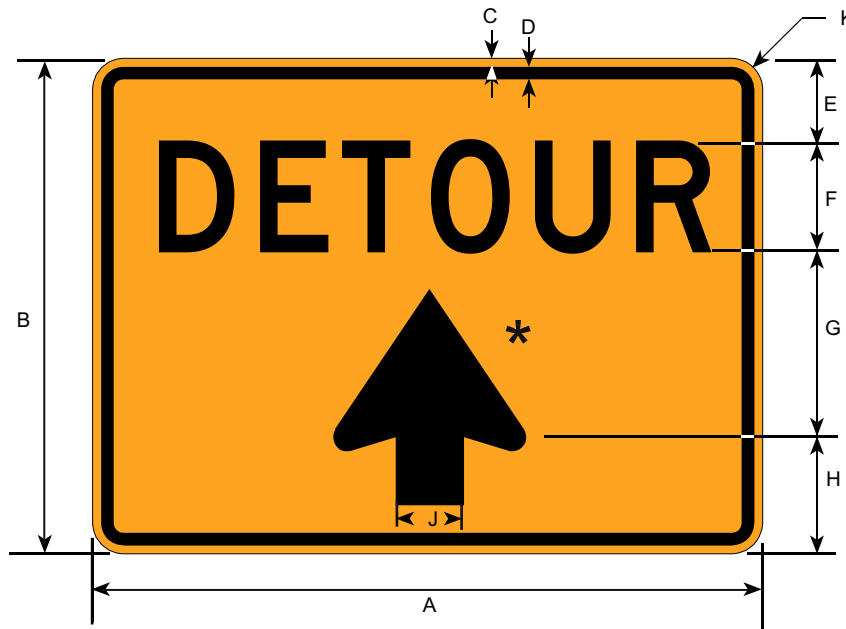

Border and Legend: Black
Background: Orange

* See Appendix B-1 for Standard Arrow Details.

Prior to the 2003 revision of this manual
this sign was numbered M4-9A.

Road Class	Dimensions (inches)									
	A	B	C	D	E	F	G	H	J	K
Minimum	30	24	0.38	0.63	4.0	5D	7.0	8.0	4.5	1.5
Conventional	48	36	0.63	0.88	6.0	8D	10	12	7.0	2.25
Expressway	60	48	0.75	1.25	8.0	10D	14	16	9.0	3.0

M5-1 M5-2

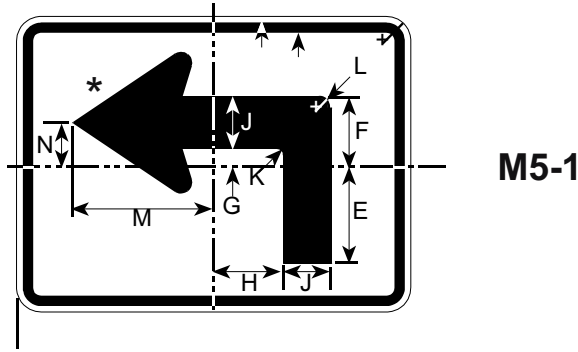

Road Class	Dimensions (inches)														
	A	B	C	D	E	F	G	H	J	K	L	M	N	P	
Minimum	21	15	0.38	0.63	5.06	3.38	0.75	3.19	2.63	0.38	0.56	7.13	2.06	1.5	

Border and Legend: Black
Background: White

Border and Legend: White
Background: Blue, Green, or Brown

* See Appendix B-1 for Standard Arrow Details.

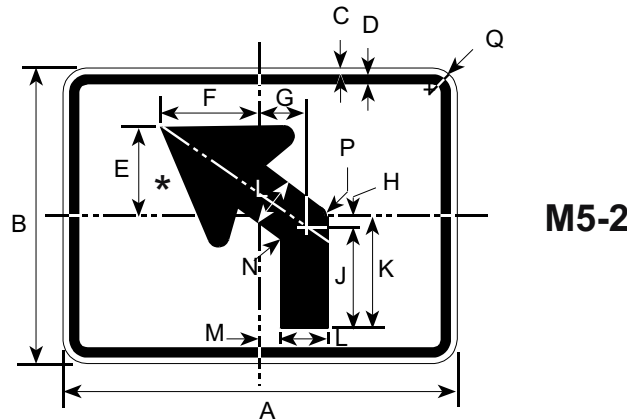

Road Class	Dimensions (inches)															
	A	B	C	D	E	F	G	H	J	K	L	M	N	P	Q	
Minimum	21	15	0.38	0.63	4.75	4.5	2.44	0.75	4.0	5.44	2.63	1.13	0.38	0.6	1.5	

M6-1 M6-2

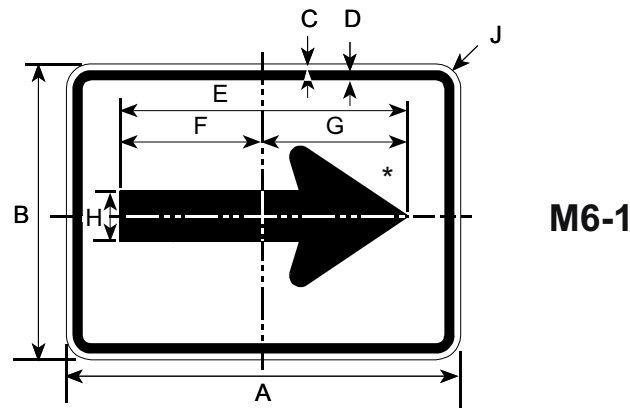

Road Class	Dimensions (inches)								
	A	B	C	D	E	F	G	H	J
Conv & Min	21	15	0.38	0.63	14.63	7.13	7.5	2.63	1.5

Border and Legend: Black, Blue, Green, or Brown
Background: White

* See Appendix B-1 for Standard Arrow Details.

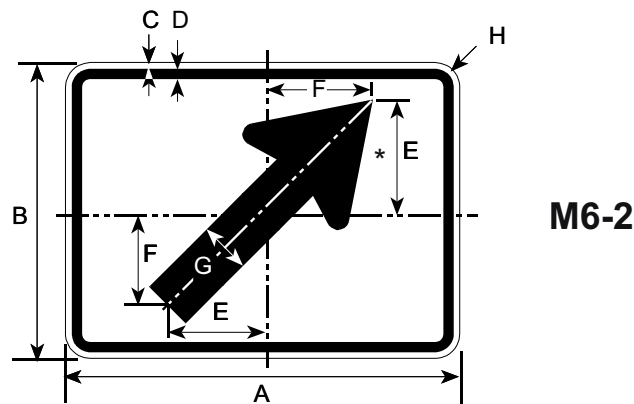

Road Class	Dimensions (inches)							
	A	B	C	D	E	F	G	H
Conv & Min	21	15	0.38	0.63	5.06	5.63	2.63	1.5

M6-3 M6-4

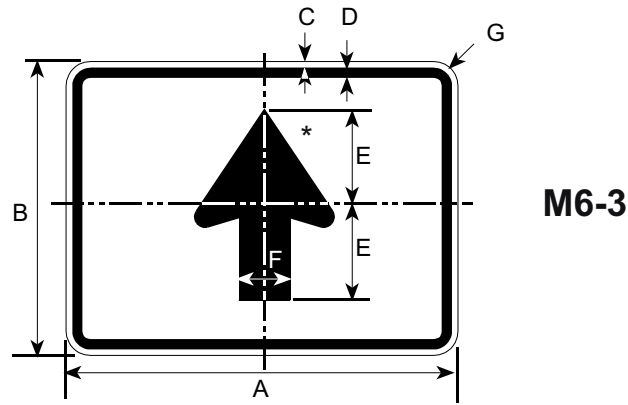

Road Class	Dimensions (inches)						
	A	B	C	D	E	F	G
Conv & Min	21	15	0.38	0.63	4.88	2.63	1.5

Border and Legend: Black, Blue, Green, or Brown
Background: White

* See Appendix B-1 for Standard Arrow Details.

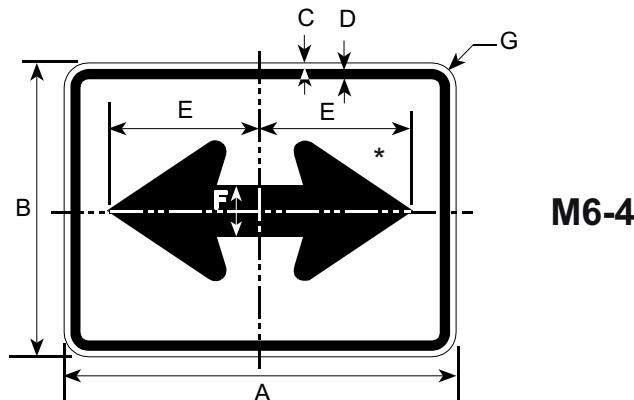

Road Class	Dimensions (inches)						
	A	B	C	D	E	F	G
Conv & Min	21	15	0.38	0.63	7.5	2.63	1.5

M6-5 M6-6

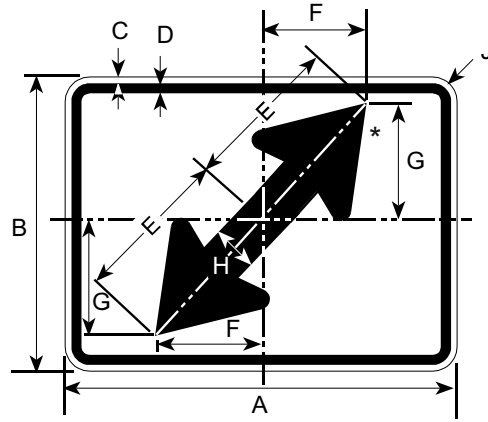

M6-5

Road Class	Dimensions (inches)									
	A	B	C	D	E	F	G	H	J	
Conv & Min	21	15	0.38	0.63	7.88	5.88	5.25	2.25	1.5	

Border and Legend: Black, Blue, Green, or Brown
Background: White

* See Appendix B-1 for Standard Arrow Details.

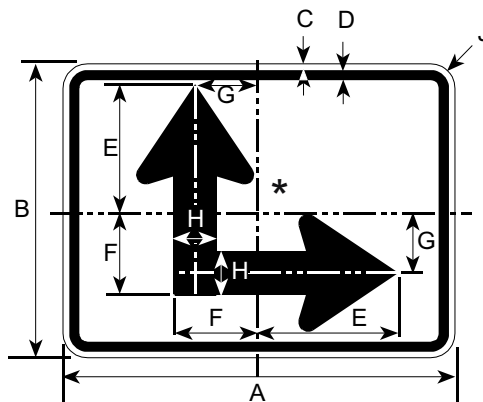

M6-6

Road Class	Dimensions (inches)									
	A	B	C	D	E	F	G	H	J	
Conv & Min	21	15	0.38	0.63	5.75	3.88	2.75	2.25	1.5	

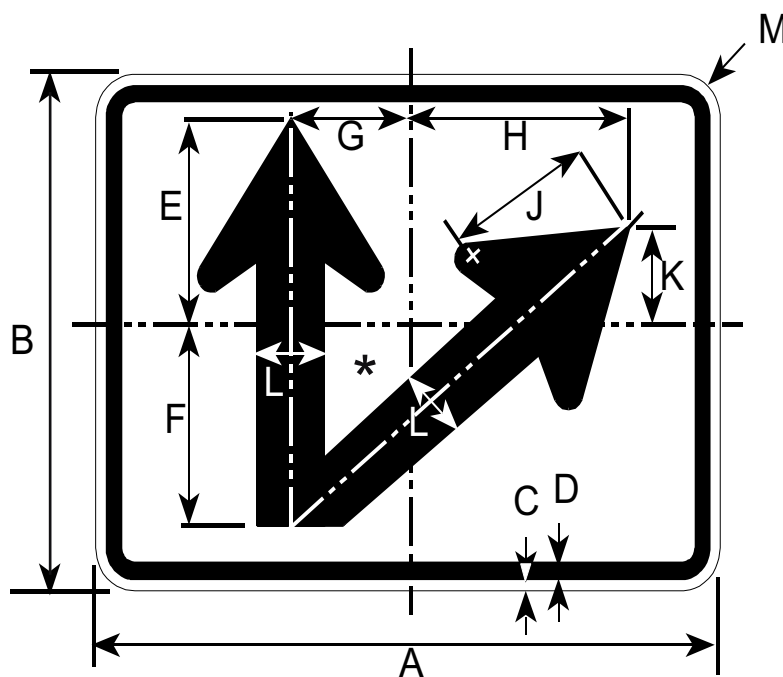

Border and Legend: Black, Blue, Green, or Brown
 Background: White

* See Appendix B-1 for Standard Arrow Details.

Road Class	Dimensions (inches)											
	A	B	C	D	E	F	G	H	J	K	L	M
Conv & Min	21	15	0.38	0.63	5.75	5.5	3.88	6.75	4.5	2.13	2.25	1.5

M6-8 M6-9

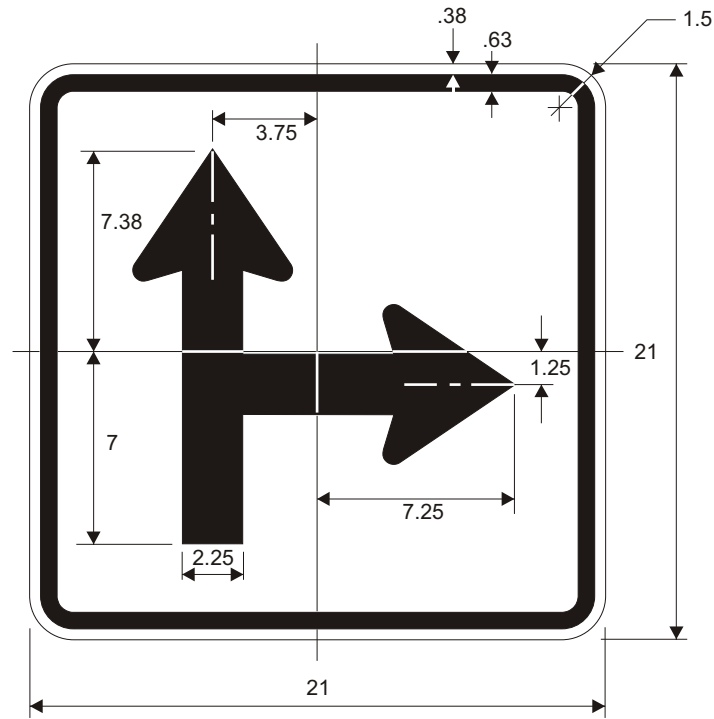

M6-8

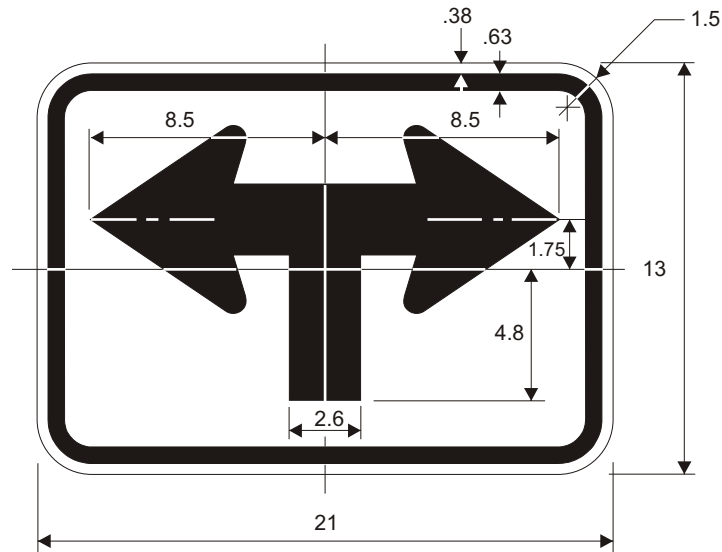

M6-9

* See Appendix B-1 for Standard Arrow Details.

Border and Legend: Black, Blue, Green, or Brown
Background: White

M7-1 M7-2 M7-3

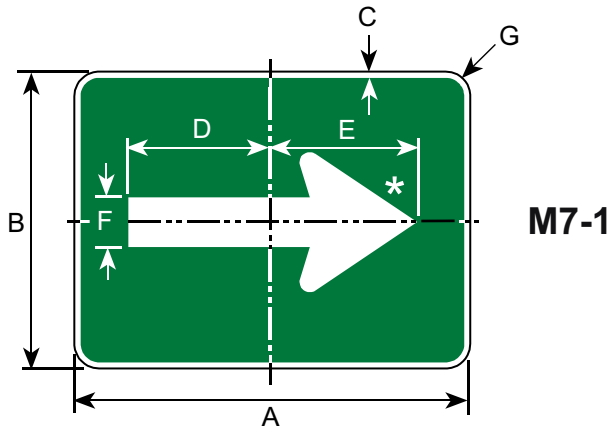

Road Class	Dimensions (inches)						
	A	B	C	D	E	F	G
Bike	12	9	0.38	4.25	4.5	1.63	1.5

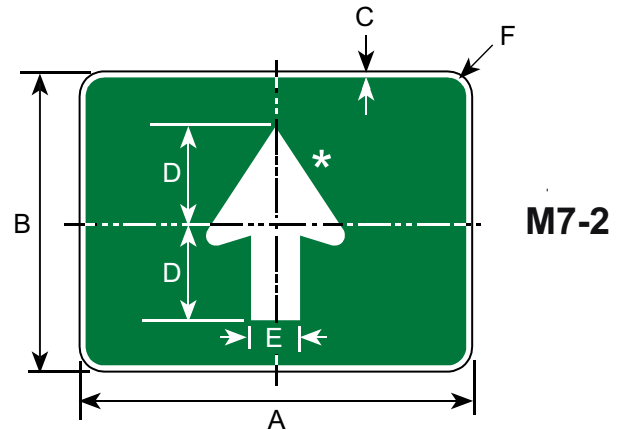

Road Class	Dimensions (inches)					
	A	B	C	D	E	F
Bike	12	9	0.38	3.0	1.63	1.5

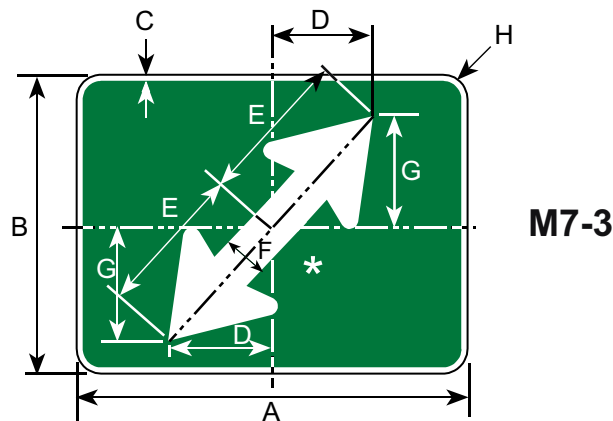

Road Class	Dimensions (inches)							
	A	B	C	D	E	F	G	H
Bike	12	9	0.38	3.63	4.5	1.38	3.0	1.5

Border and Legend: White
Background: Green

* See Appendix B-1 for Standard Arrow Details.

M7-4
M7-5
M7-6
M7-7

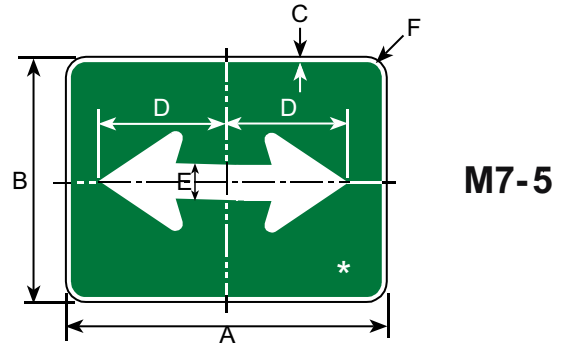
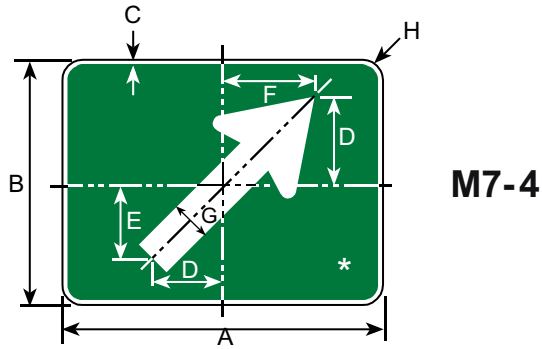

Road Class	Dimensions (inches)							
	A	B	C	D	E	F	G	H
Bike	12	9	0.38	3.0	2.63	3.38	1.63	1.5

Road Class	Dimensions (inches)					
	A	B	C	D	E	F
Bike	12	9	0.38	4.38	1.63	1.5

Border and Legend: White
 Background: Green

* See Appendix B-1 for Standard Arrow Details.

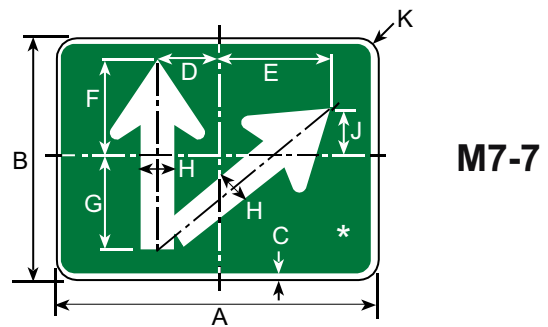
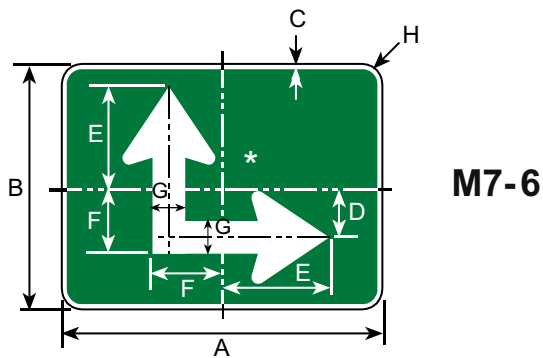

Road Class	Dimensions (inches)							
	A	B	C	D	E	F	G	H
Bike	12	9	0.38	1.63	3.38	2.25	1.38	1.5

Road Class	Dimensions (inches)									
	A	B	C	D	E	F	G	H	J	K
Bike	12	9	0.38	2.25	4.0	3.38	3.13	1.38	1.25	1.5

M11-1

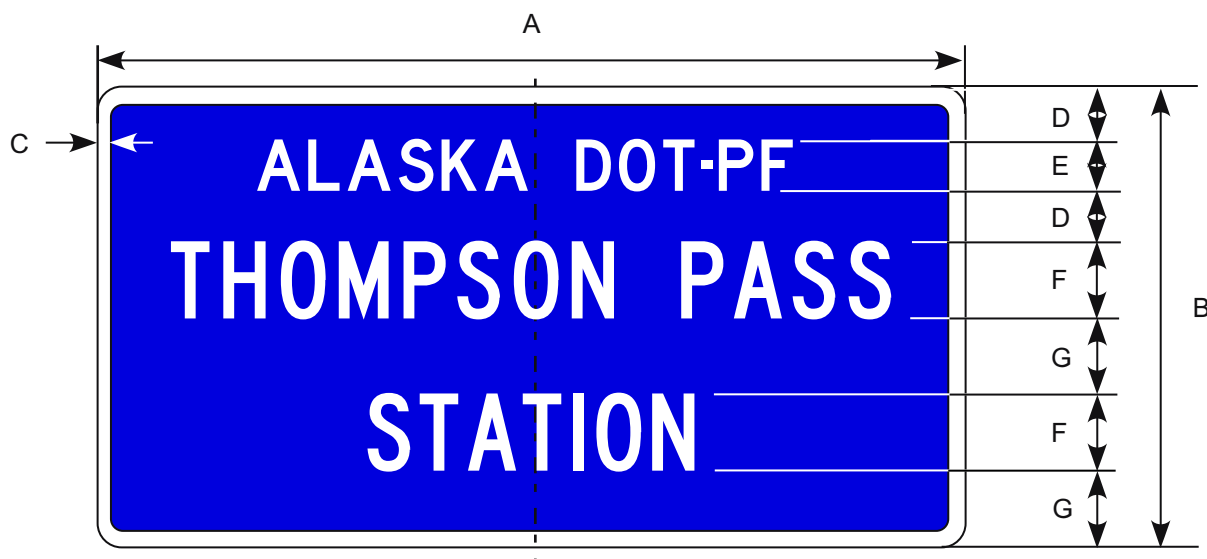

Border and Legend: White
Background: Blue

Road Class	Dimensions (inches)						
	A	B	C	D	E	F	G
Conventional	Variable	36	1	4	4D	6C	6

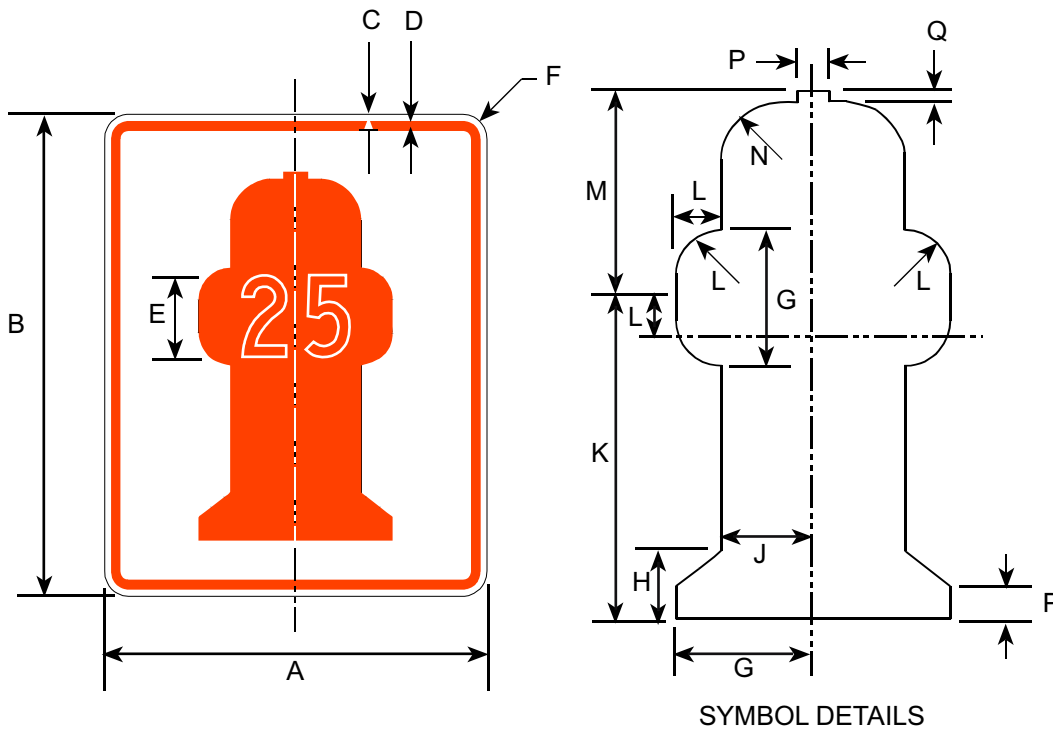

Border and Symbol: Red
Background: White

Road Class	Dimensions (inches)														
	A	B	C	D	E	F	G	H	J	K	L	M	N	P	Q
Conv & Min	24	30	0.38	0.63	5C	1.5	6	3	4	13	2	9	2.5	1.5	0.5

OBJECT MARKERS

OM1-1 to OM4-3

OM1-1
OM1-2
OM1-3

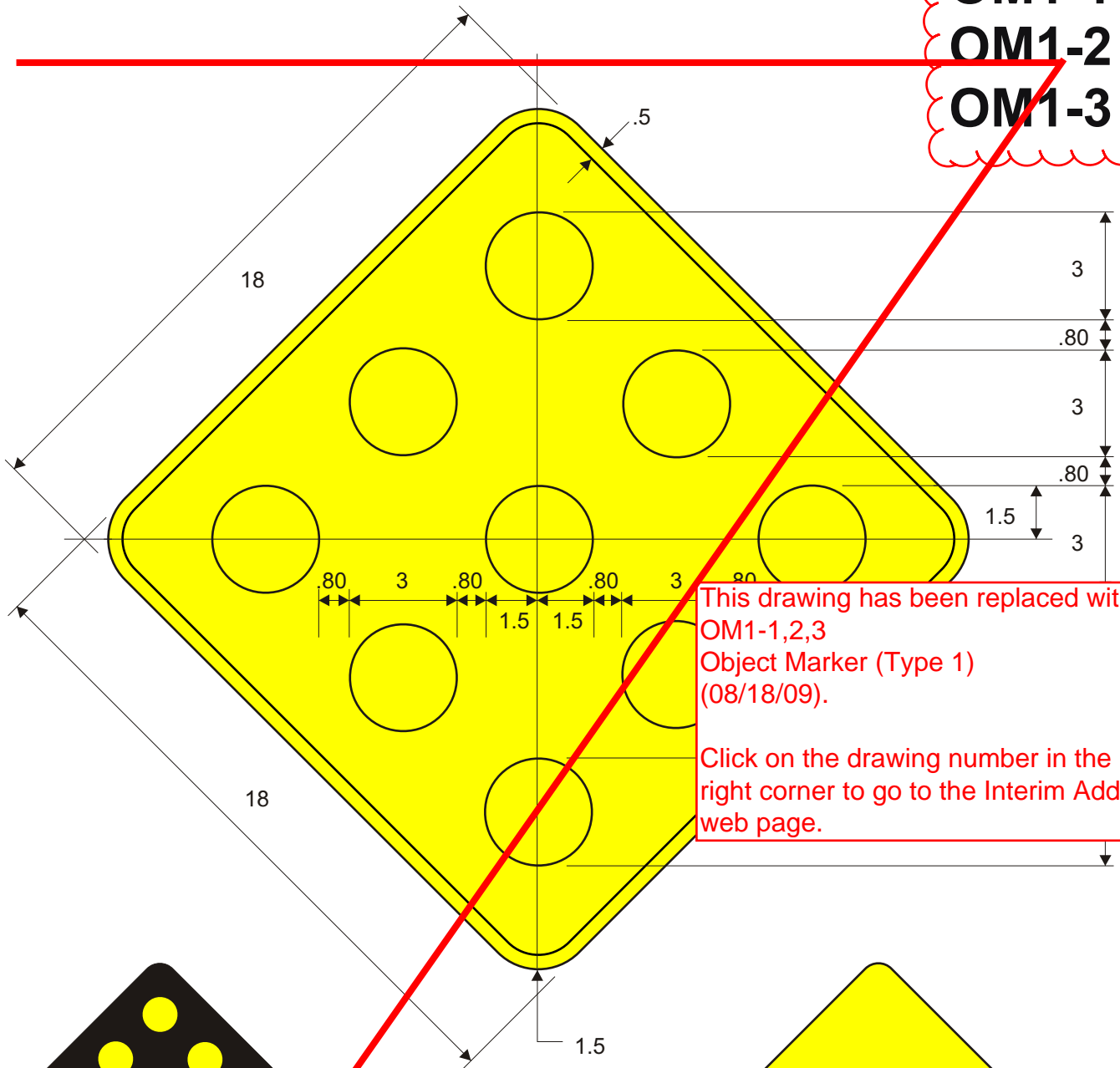

This drawing has been replaced with
OM1-1,2,3
Object Marker (Type 1)
(08/18/09).
Click on the drawing number in the upper
right corner to go to the Interim Addenda
web page.

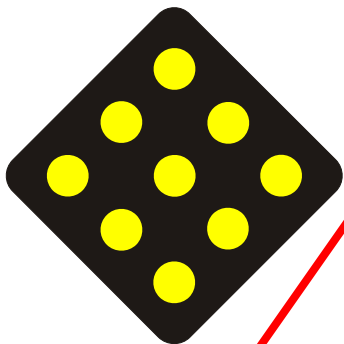

OM1-2

OM1-2 COLORS:
Reflectors: Yellow
Background: Black

OM1-1

OM1-1 COLORS:
Reflectors: Yellow
Background: Yellow
Border: Yellow

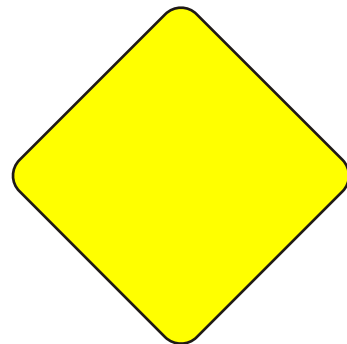

OM1-3

OM1-3 COLORS:
Sign Panel: Yellow

**OM2-1H
OM2-1V
OM2-2H
OM2-2V**

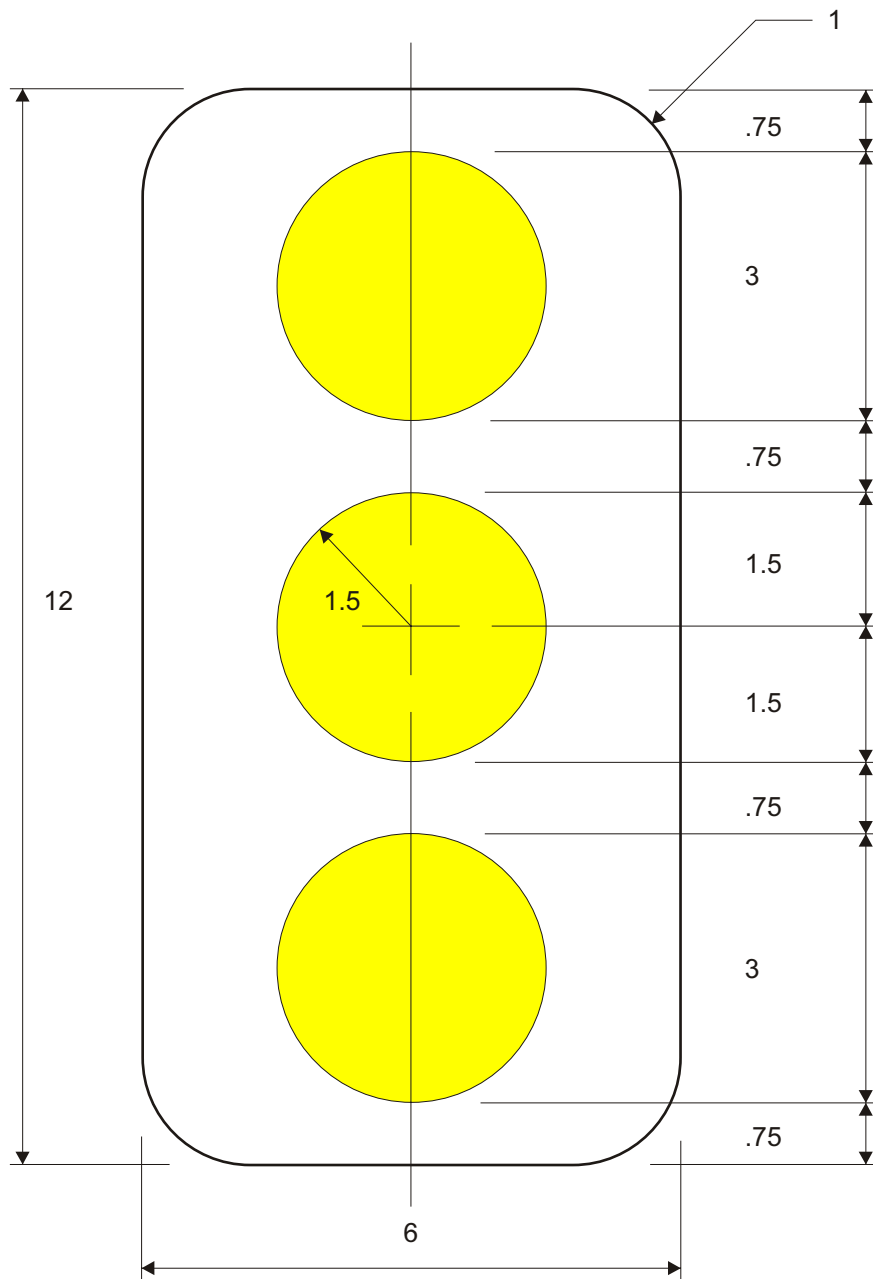

OM2-1V

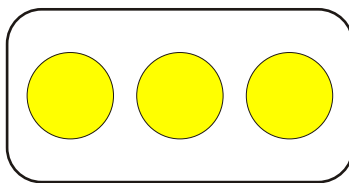

OM2-1H

OM2-1 COLORS:
Reflectors: Yellow
Background: White

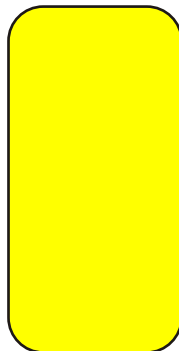

OM2-2V



OM2-2H

OM2-2 COLORS:
Sign Panel: Yellow

OM-3L
OM-3C
OM-3R

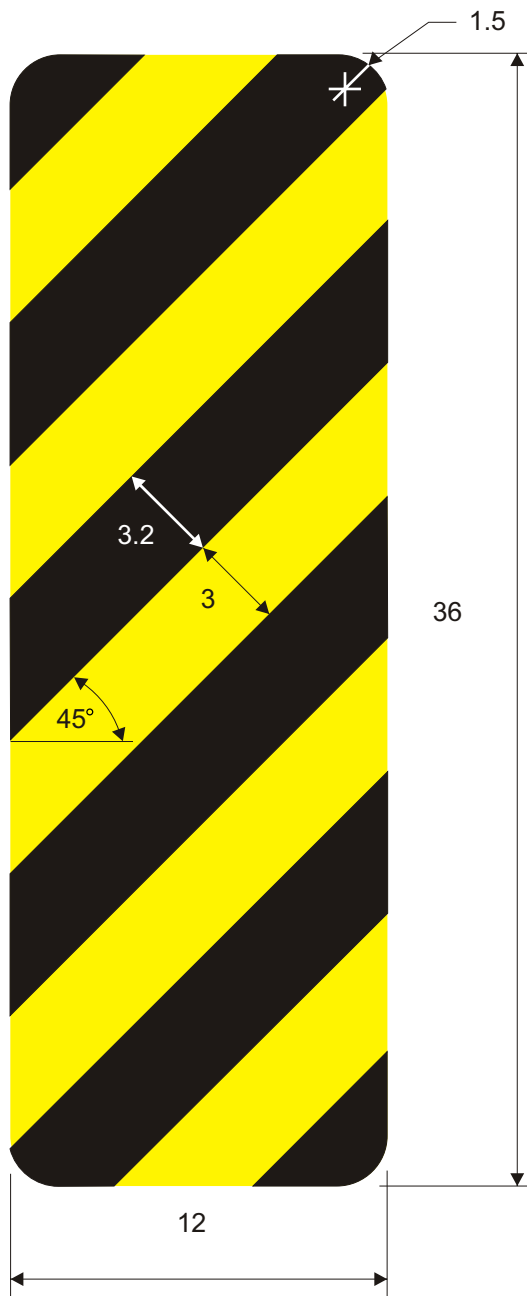

OM-3R

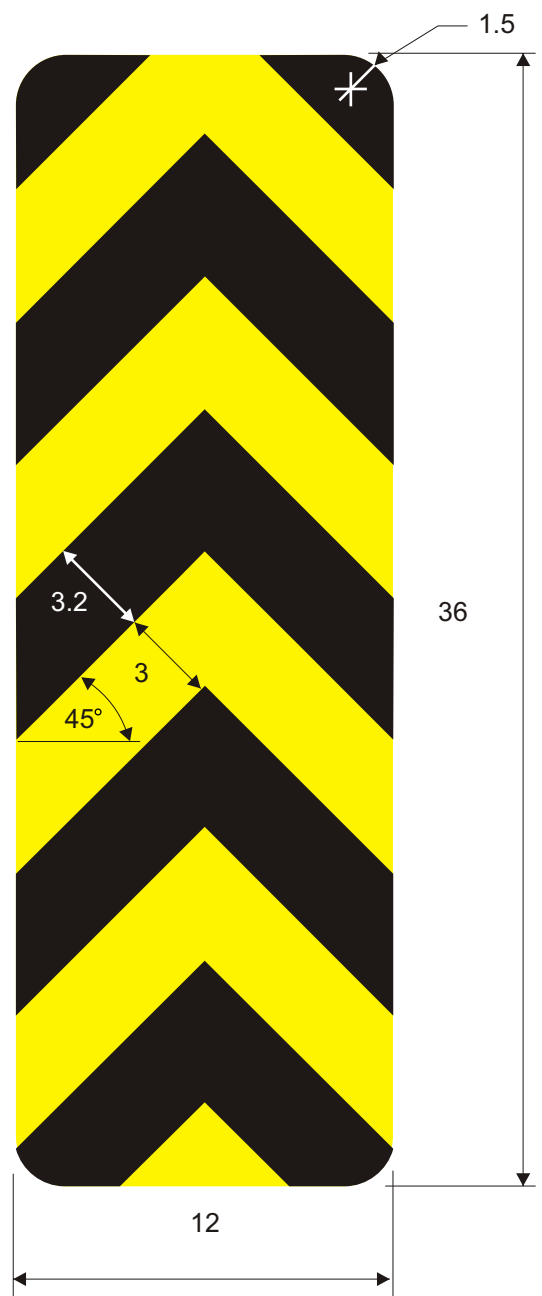

OM-3C



OM-3L

Stripes: Black
Background: Yellow

OM4-1
OM4-2
OM4-3

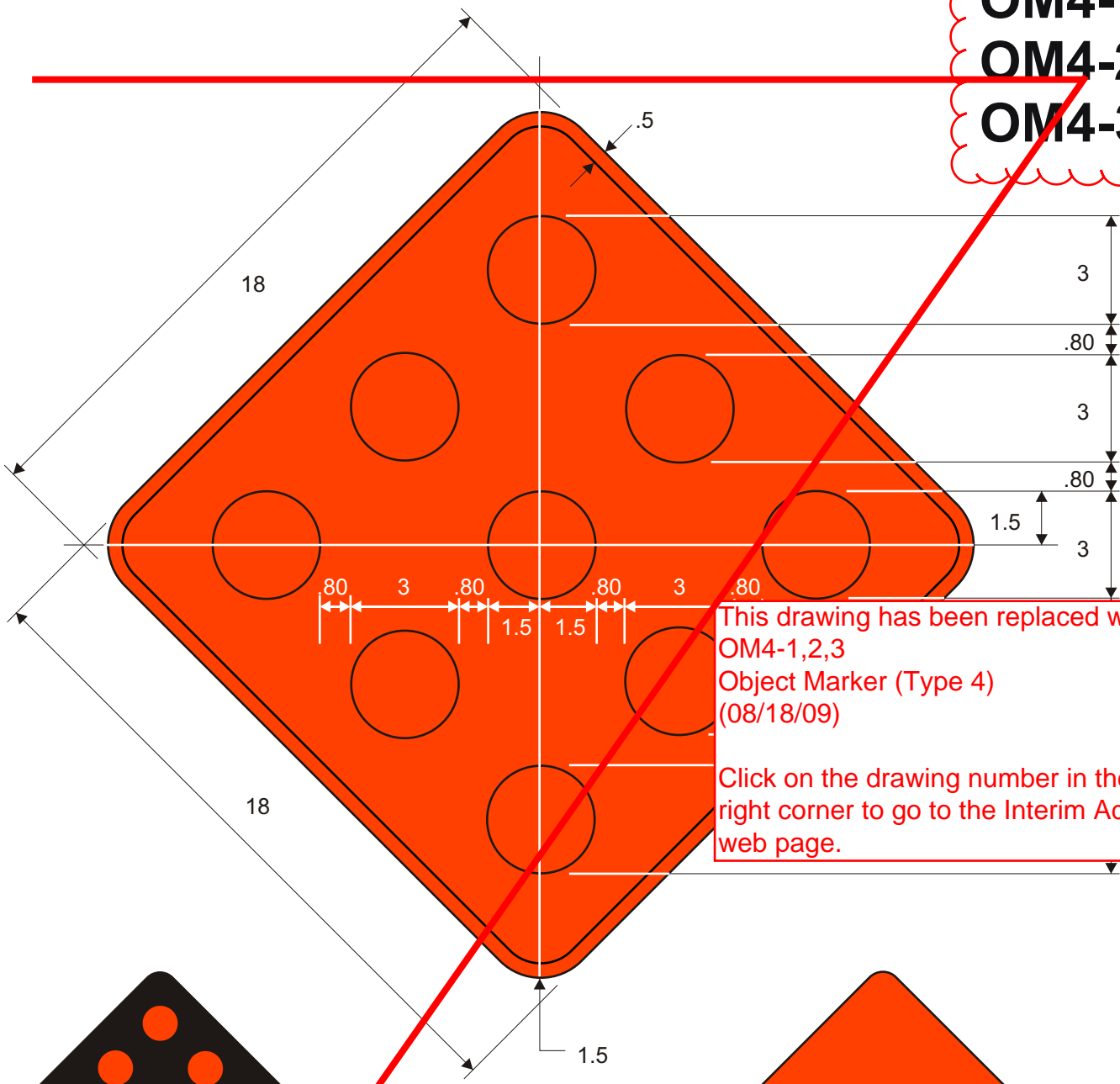

This drawing has been replaced with:
 OM4-1,2,3
 Object Marker (Type 4)
 (08/18/09)

Click on the drawing number in the upper right corner to go to the Interim Addenda web page.

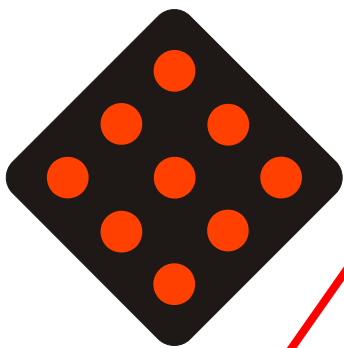

OM4-2

OM4-2 COLORS:
 Reflectors: Red
 Background: Black

OM4-1

OM4-1 COLORS:
 Reflectors: Red
 Background: Red
 Border: Red

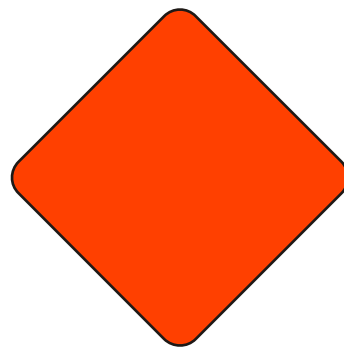

OM4-3

OM4-3 COLORS:
 Sign Panel: Red

REGULATORY SIGNS

R1-1 to R16-115

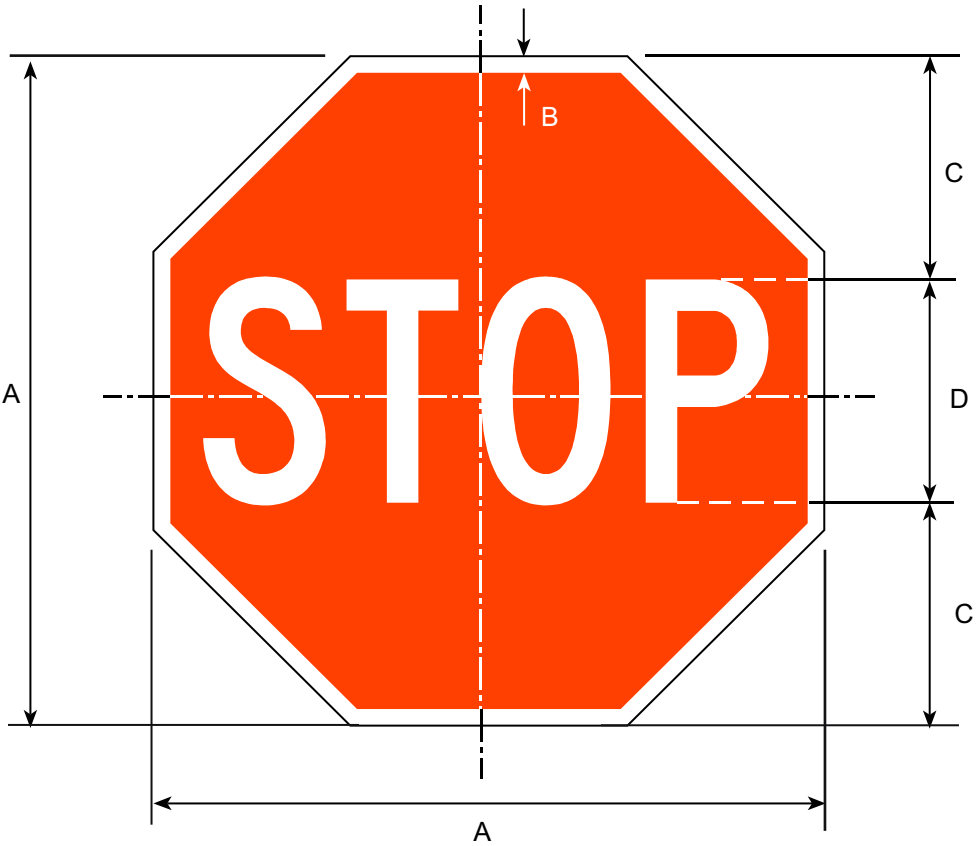

Border and Legend: White
Background: Red

Road Class	Dimensions (inches)			
	A	B	C	D
Bike	18	0.38	6	6C
Minimum	24	0.63	8	8C
Conventional	30	0.75	10	10C
Expressway	36	0.88	12	12C
Oversized	48	1.25	16	16C

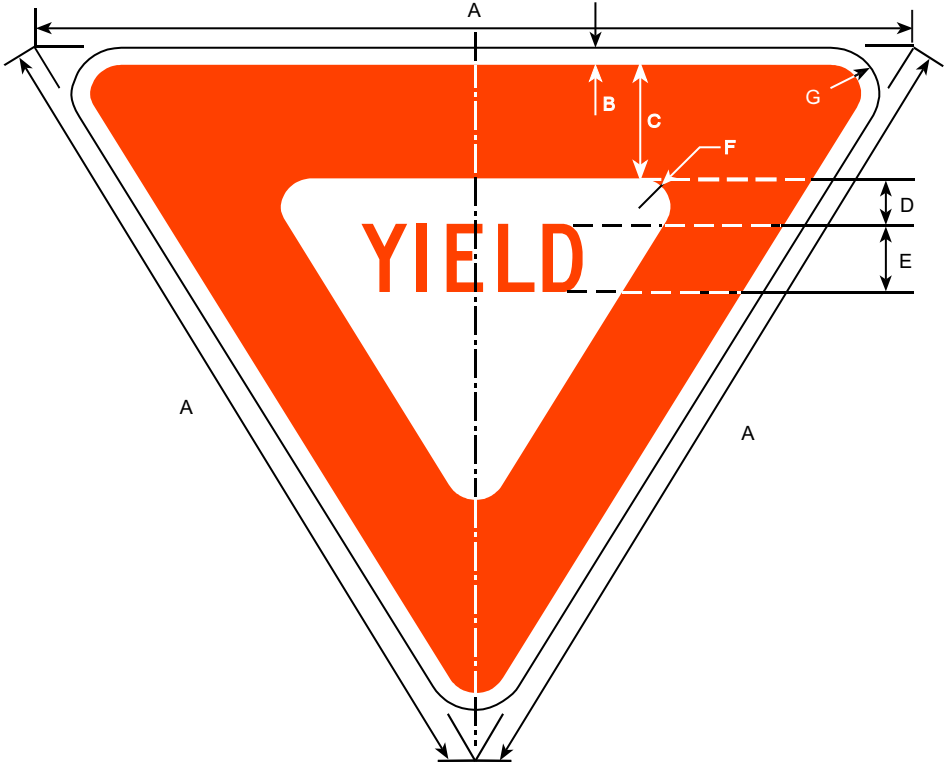

Margin and Central Background: White
 Outer Background and Legend: Red

Road Class	Dimensions (inches)						
	A	B	C	D	E	F	G
Bike	24	0.38	3	1.38	2C	0.88	1.50
Minimum	30	0.63	4	1.75	2 1/2C	0.88	1.50
Conventional	36	0.75	5	2.00	3C	1.25	2.00
Expressway	48	1.00	6	2.75	4C	2.00	3.00
Oversized	60	1.50	8	3.50	5C	2.50	4.00

R1-2A

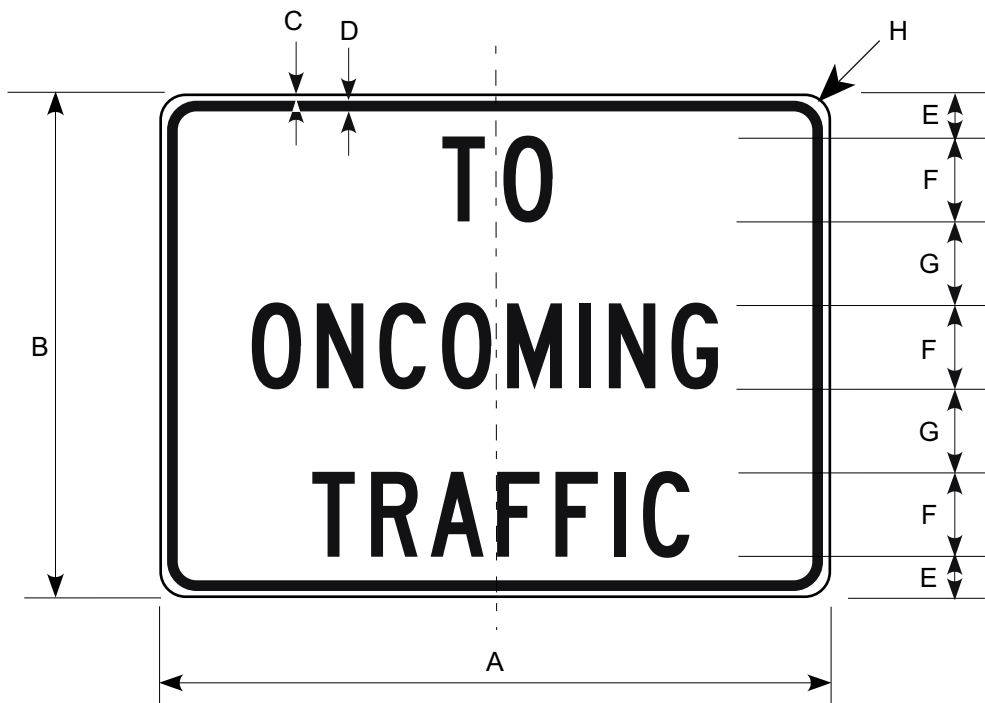

Border and Legend: Black
Background: White

Road Class	Dimensions (inches)							
	A	B	C	D	E	F	G	H
Conv & Min	24	18	0.5	0.75	1.5	3C	3	1.5

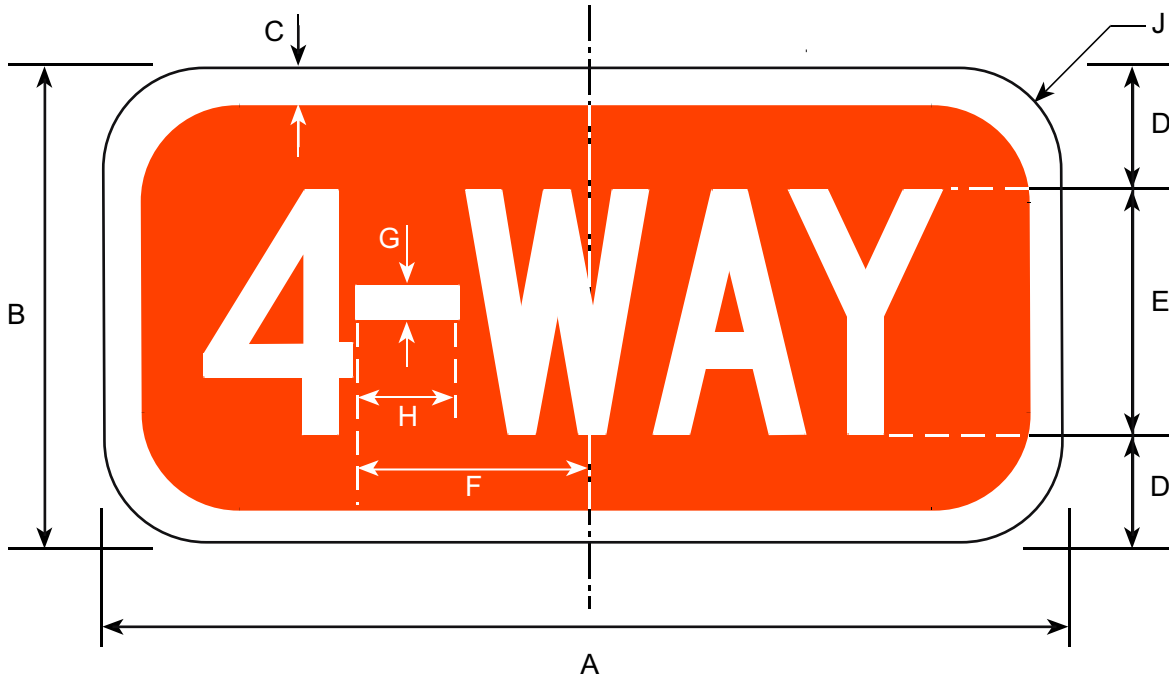

Border and Legend: White
Background: Red

Class	Dimensions (inches)								
	A	B	C	D	E	F	G	H	J
Conv & Min	12	6	0.50	1.50	3C	2.75	0.42	1.06	1.50

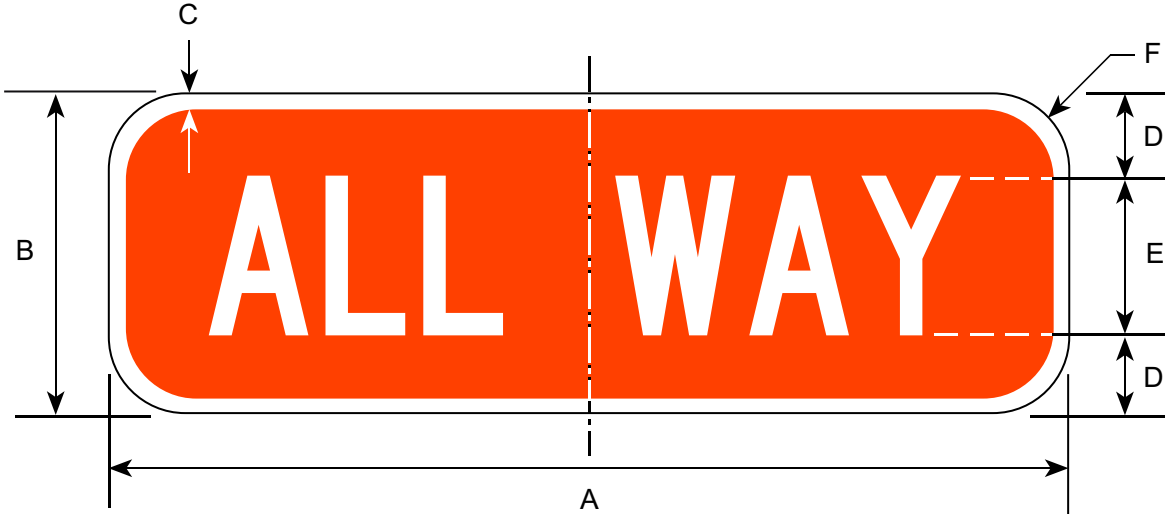

Border and Legend: White
Background: Red

Road Class	Dimensions (inches)					
	A	B	C	D	E	F
Conv & Min	18	6	0.50	1.50	3C	1.50

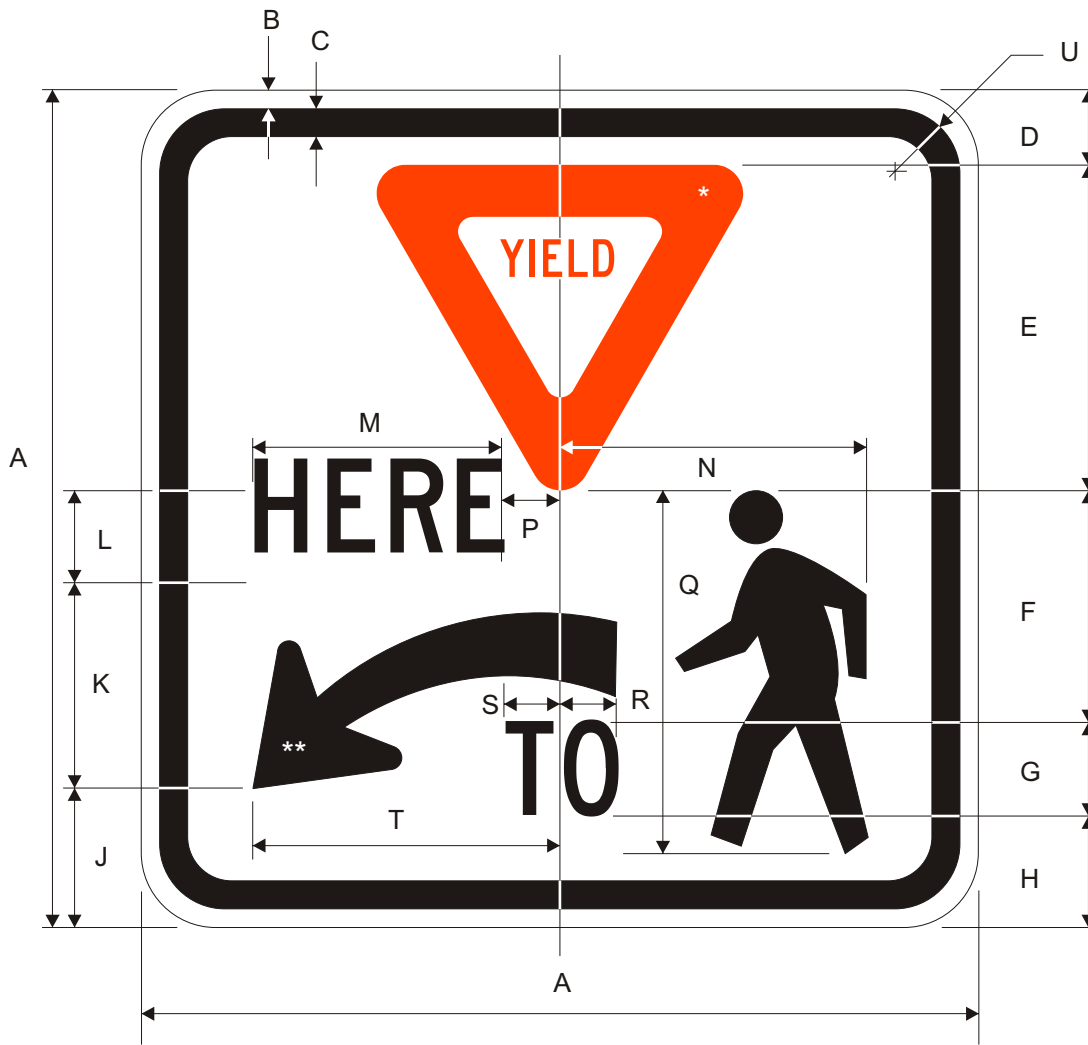

Road Class	Dimensions (inches)										
	A	B	C	D	E	F	G	H	J	K	L
Bike	18	0.38	0.63	1.62	7.0	5.0	2C	2.38	3.0	4.38	2C
Min	30	0.50	0.75	2.75	11.5	8.5	3C	4.25	5.0	7.25	3C
Conv.	36	0.63	0.88	3.25	14	10	4C	4.75	6.0	8.75	4C

M	N	P	Q	R	S	T	U
5.36	6.61	1.24	7.81	1.22	1.22	6.61	1.5
8.06	11	2.0	13	1.82	1.82	11	1.88
10.73	13.21	2.48	15.61	2.44	2.44	13.21	2.25

Legend and Arrow: Black
 Ped Symbol: Black
 Background: White
 Yield Symbol: Red

*Insert R1-2 and size to fit.
 **See Appendix B-1 for Standard Arrow Details.

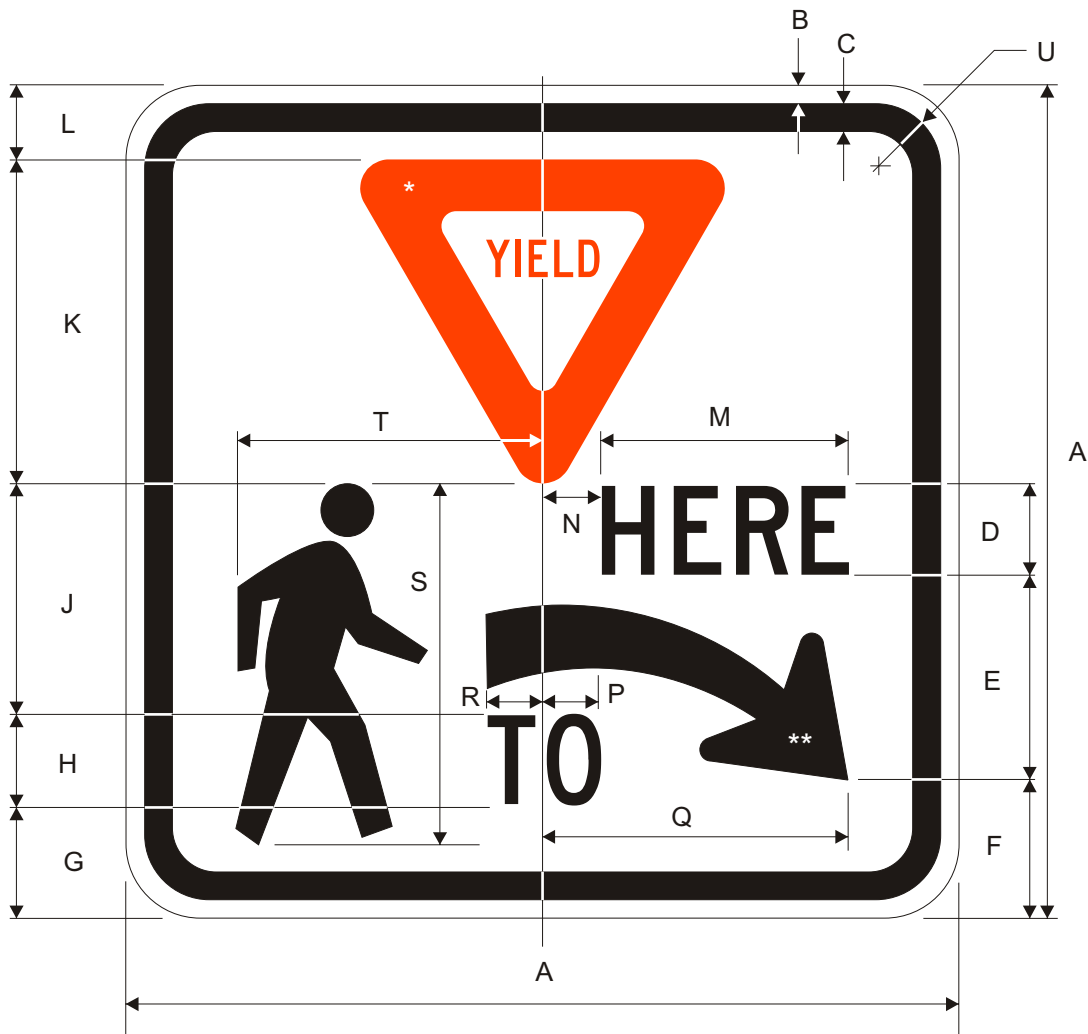

Road Class	Dimensions (inches)										
	A	B	C	D	E	F	G	H	J	K	L
Bike	18	0.38	0.63	2C	4.38	3.0	2.38	2C	5.0	7.0	1.62
Min.	30	0.50	0.75	3C	7.25	5.0	4.25	3C	8.5	11.5	2.75
Conv.	36	0.63	0.88	4C	8.75	6.0	4.75	4C	10	14	3.25

M	N	P	Q	R	S	T	U
5.36	1.24	1.22	6.61	1.22	7.81	6.61	1.5
8.06	2.0	1.82	11	1.82	13	11	1.88
10.73	2.48	2.44	13.21	2.44	15.61	13.21	2.25

*Insert R1-2 and size to fit.

**See Appendix B-1 for Standard Arrow Details.

Legend and Arrow: Black
 Ped Symbol: Black
 Background: White
 Yield Symbol: Red



Road Class	Dimensions (inches)										
	A	B	C	D	E	F	G	H	J	K	L
Bike	18	24	0.38	0.63	2.0	8.0	0.75	2C	3.62	1.25	2.38
Min.	30	42	0.50	0.75	5.0	13.5	1.25	3C	6.0	2.0	5.25
Conv.	36	48	0.63	0.88	4.0	16	1.5	4C	7.25	2.5	4.75

M	N	P	Q	R	S	T	U
5.36	1.76	5.60	2.43	2.40	7.125	6.0	1.50
8.06	2.62	9.38	3.64	4.36	10.68	10	1.88
10.74	3.52	11.2	4.85	4.85	14.24	12	2.25

Legend and Arrow: Black
 Background: White
 Yield Symbol: Red

*Insert R1-2 and size to fit.
 **See Appendix B-1 for Standard Arrow Details.

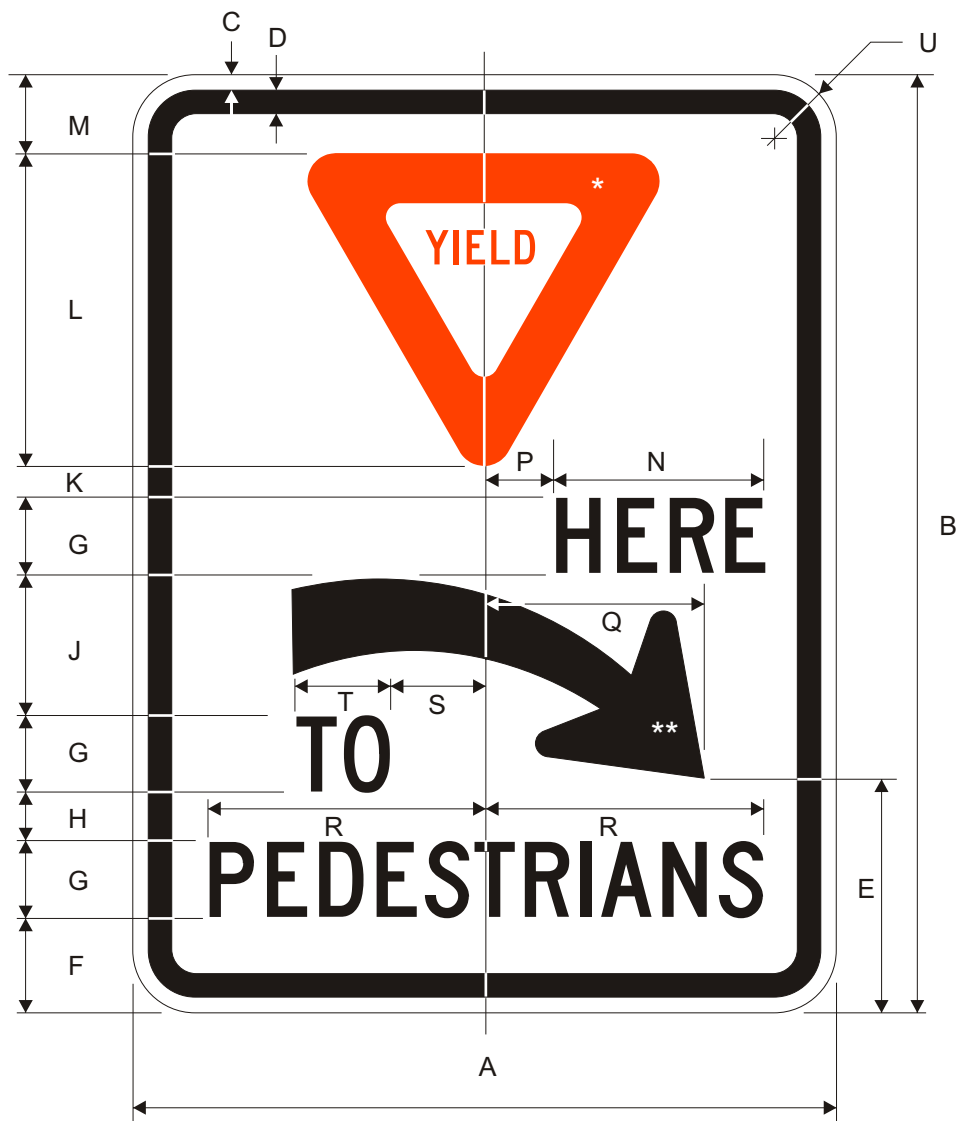

Road Class	Dimensions (inches)										
	A	B	C	D	E	F	G	H	J	K	L
Bike	18	24	0.38	0.63	6.0	2.38	2C	1.25	3.62	0.75	8.0
Min.	30	42	0.50	0.75	10	5.25	3C	2.0	6.0	1.25	13.5
Conv.	36	48	0.63	0.88	12	4.75	4C	2.5	7.25	1.5	16

M	N	P	Q	R	S	T	U
2.0	5.36	1.8	5.6	7.13	2.40	2.43	1.50
5.0	8.1	2.6	9.4	10.7	4.36	3.64	1.88
4.0	10.74	3.5	11.2	14.2	4.80	4.85	2.25

Legend and Arrow: Black
 Background: White
 Yield Symbol: Red

*Insert R1-2 and size to fit.
 **Insert R10-6a Arrow and reduce to fit.

R1-6

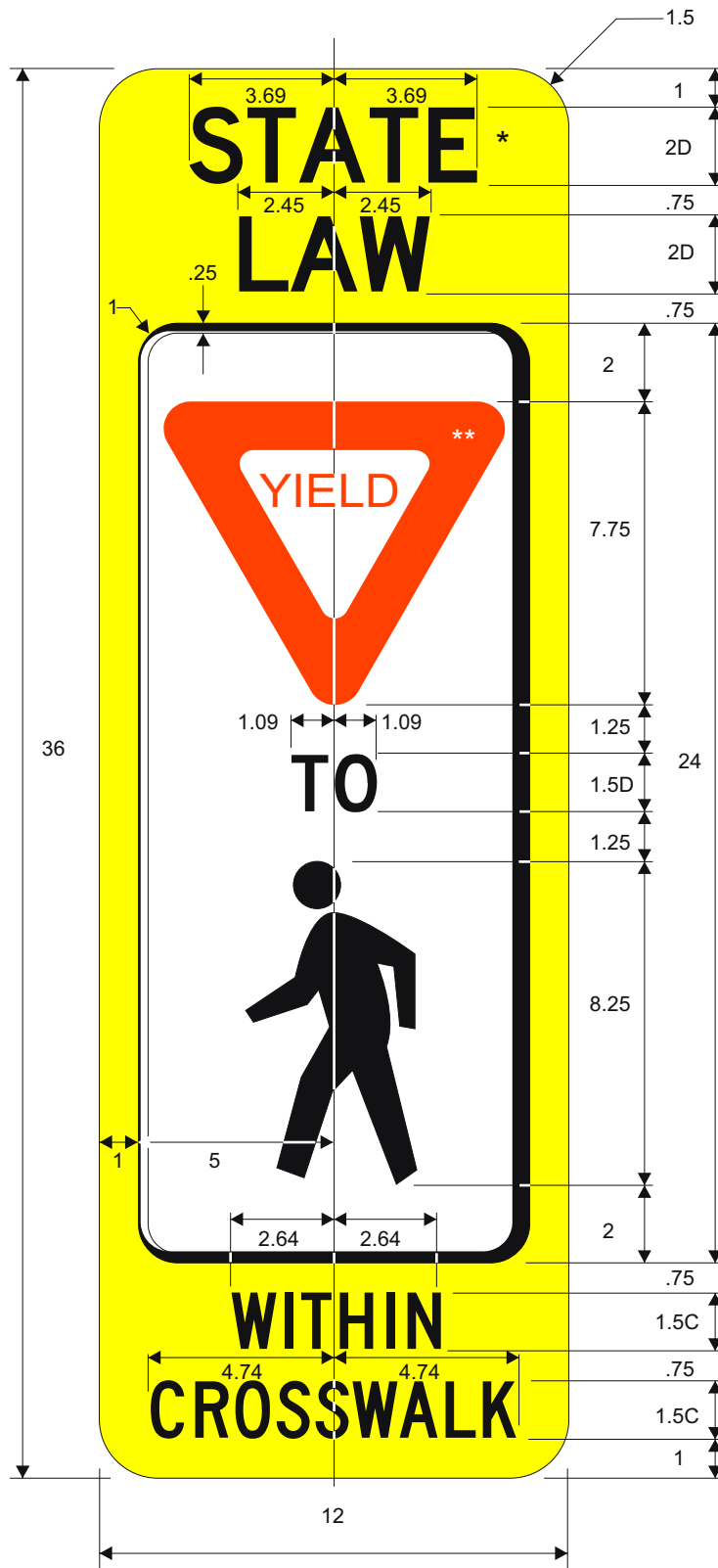

*Legend is optional.

**Insert R1-2 and size to fit.

Legend: Black
 Background: Yellow
 Yield Symbol: Red
 Ped Symbol: Black on White

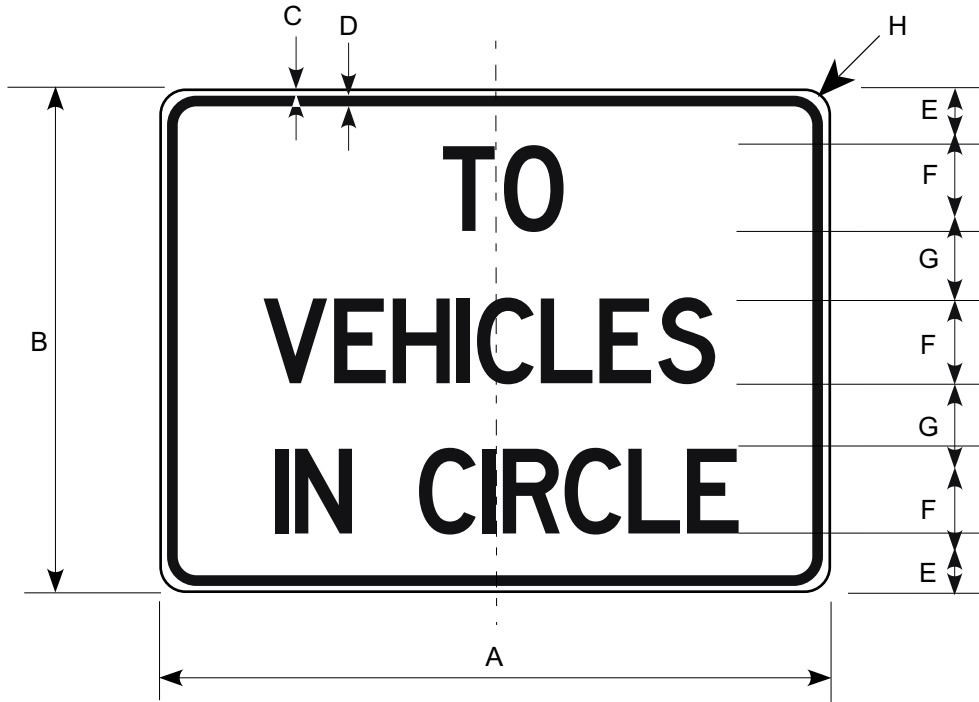

Border and Legend: Black
Background: White

Road Class	Dimensions (inches)							
	A	B	C	D	E	F	G	H
Conv & Min	24	18	0.5	0.75	1.5	3D	3	1.5



Border and Legend: Black
 Background: White

Road Class	Dimensions (inches)								
	A	B	C	D	E	F	G	H	J
Minimum	24	30	0.38	0.63	4.0	4E	2.0	10E	1.5
Conventional	30	36	0.50	0.75	4.0	5E	3.0	12E	1.88
Expressway	36	48	0.63	0.88	6.0	6E	5.0	14E	2.25
Freeway	48	60	0.75	1.25	8.0	8E	6.0	16E	3.0

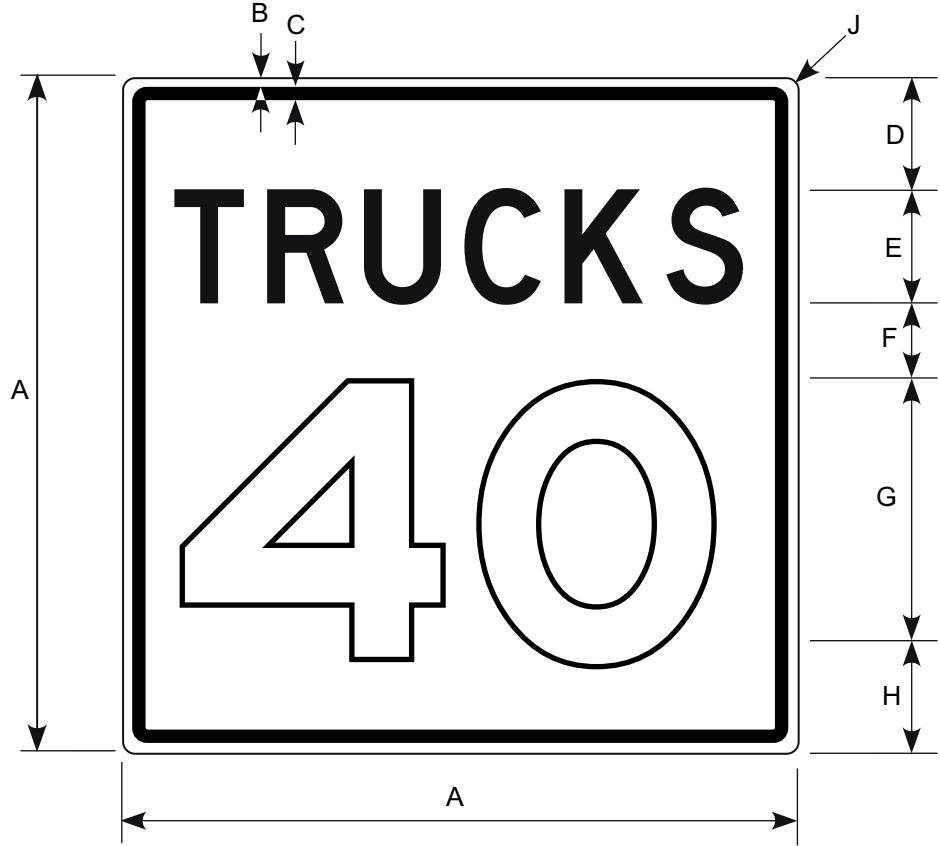

Border and Legend: Black
 Background: White

Road Class	Dimensions (inches)								
	A	B	C	D	E	F	G	H	J
Minimum	24	0.38	0.63	4.0	4D	2.5	10E	3.5	1.5
Conventional	36	0.63	0.88	6.0	6D	4.0	14E	6.0	2.25
Expwy/Fwy	48	0.75	1.25	8.0	8D	8.0	16E	8.0	3.0



Border and Legend: Black
Background: White

* Speed limit is variable.

Road Class	Dimensions (inches)								
	A	B	C	D	E	F	G	H	J
Conv & Min	24	30	0.38	0.63	4	4C	2	10D	1.50
Expressway	36	48	0.63	0.88	6	6C	5	14D	2.25
Freeway	48	60	0.75	1.25	8	8C	6	16D	3.00

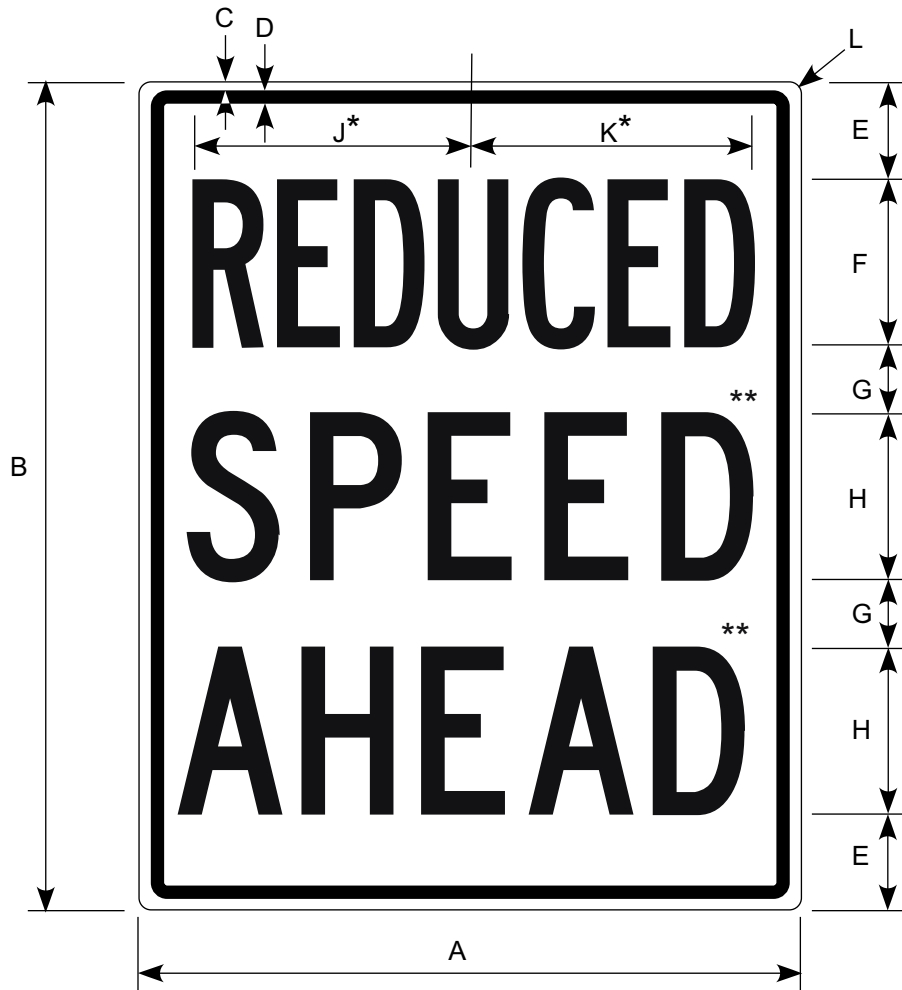

Border and Legend: Black
Background: White

* Reduce letter spacing 50% for Conventional size and 25% for other sizes.

** Reduce letter spacing 40% for Conventional size.

Road Class	Dimensions (inches)										
	A	B	C	D	E	F	G	H	J	K	L
Minimum	18	24	0.38	0.63	3.50	4B	2.5	4C	6.88	7.00	1.50
Conventional	24	30	0.38	0.63	3.50	6B	2.5	6C	10.00	10.19	1.50
Expressway	36	48	0.63	0.88	7.00	8B	5.0	8C	14.25	14.75	2.25
Freeway	48	60	0.75	1.25	9.00	10B	6.0	10C	17.75	18.44	3.00



Border and Legend: Black
Background: White

* Reduce letter spacing 40% for Conventional size

Road Class	Dimensions (inches)							
	A	B	C	D	E	F	G	H
Minimum	24	30	0.38	0.63	3.5	6C	2.5	1.5
Conventional	30	36	0.50	0.75	4.0	7C	3.0	2.0
Expressway	36	48	0.63	0.88	7.0	8C	5.0	2.25
Freeway	48	60	0.75	1.25	9.0	10C	6.0	3.0

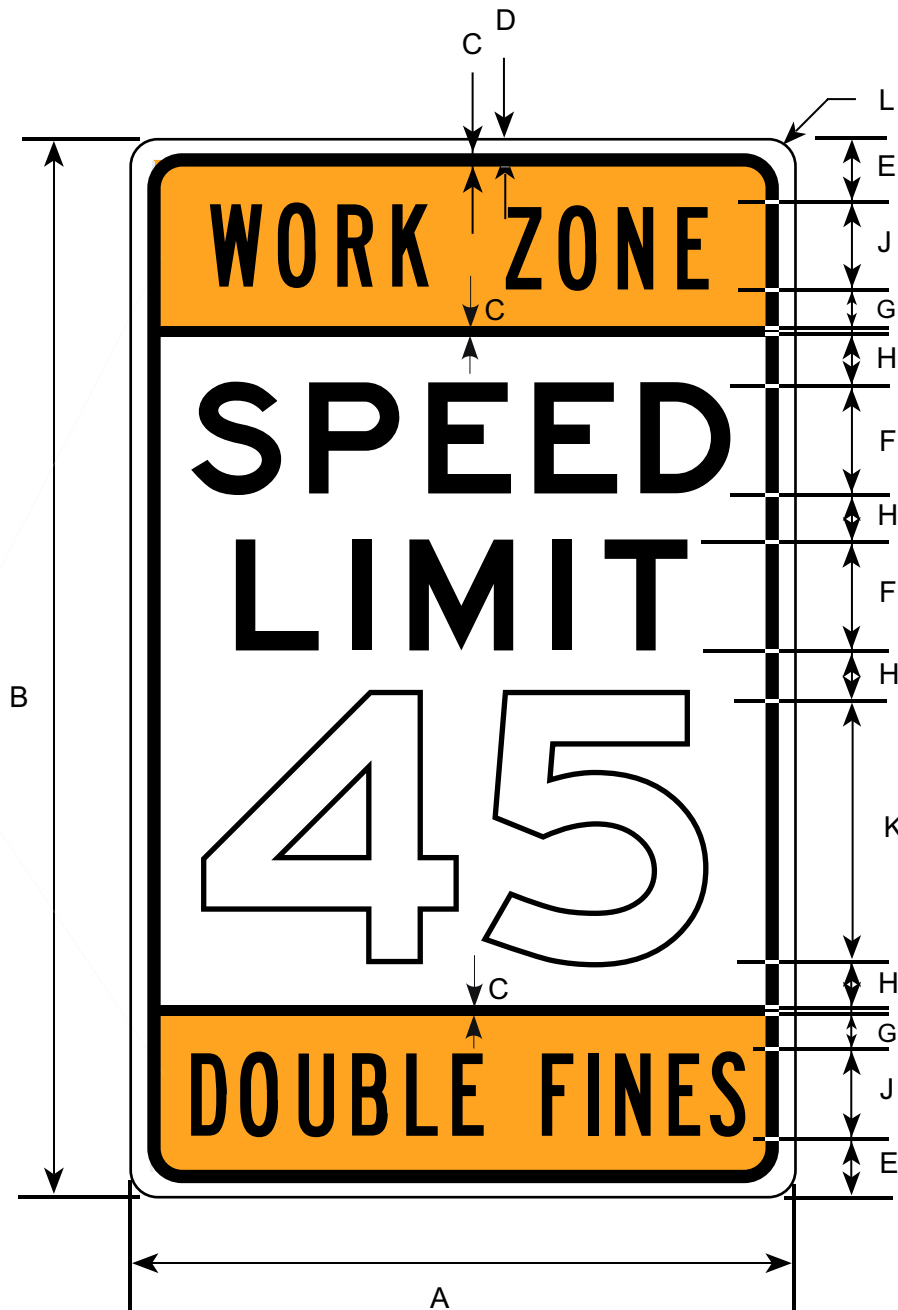

Border and Legend: Black
 Middle Background: White
 Upper & Lower Background: Orange

Prior to the 2002 publication of this manual, this sign was numbered AK-CR2-100.

Road Class	Dimensions (inches)										
	A	B	C	D	E	F	G	H	J	K	L
Conv & Min	30	48	0.88	0.63	2.50	5E	1.12	2.25	4B	12E	2.25

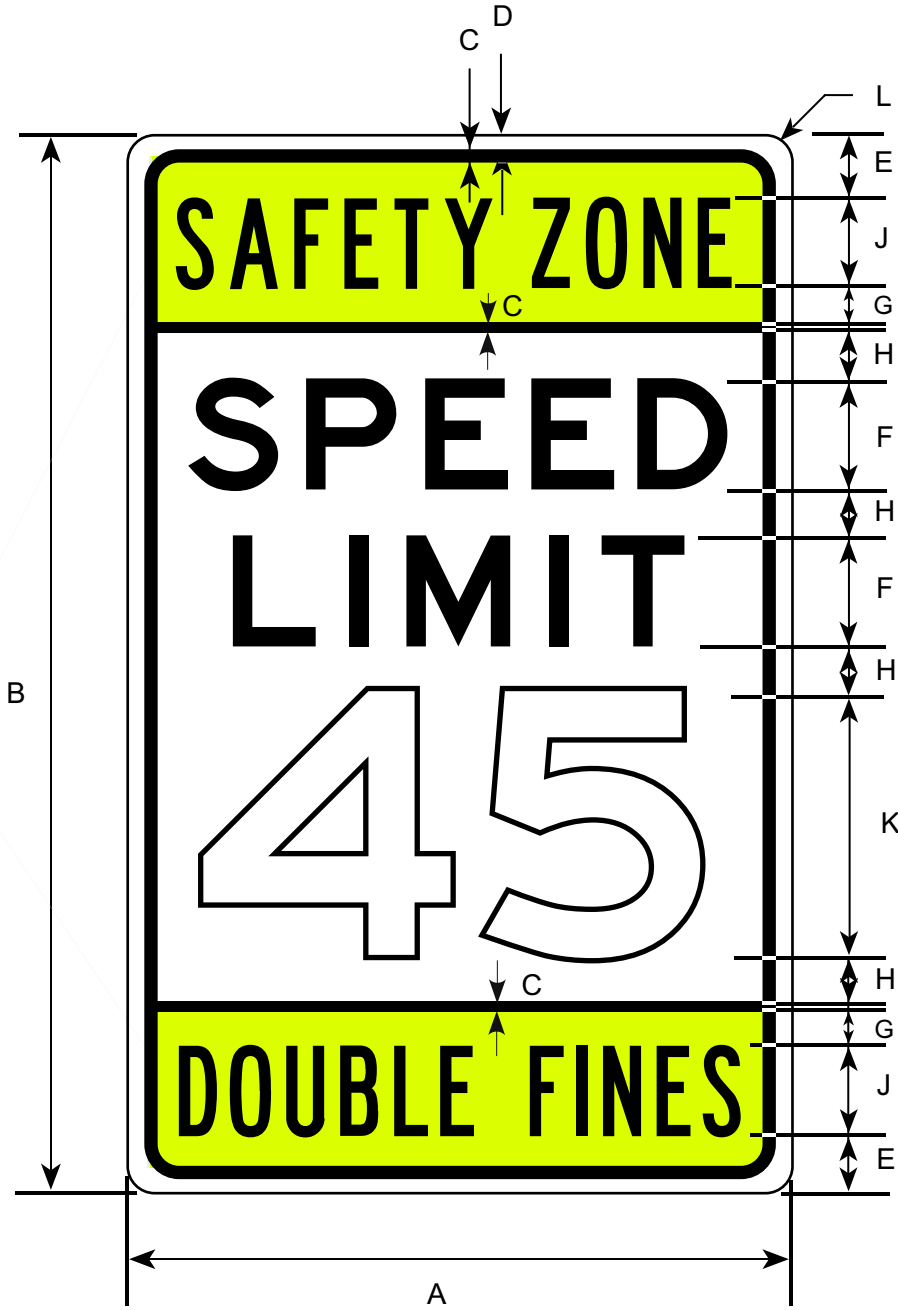

Border and Legend: Black
 Middle Background: White
 Upper & Lower Background: Fluorescent Yellow

Road Class	Dimensions (inches)										
	A	B	C	D	E	F	G	H	J	K	L
Conv & Min	30	48	0.88	0.63	2.50	5E	1.12	2.25	4B	12E	2.25

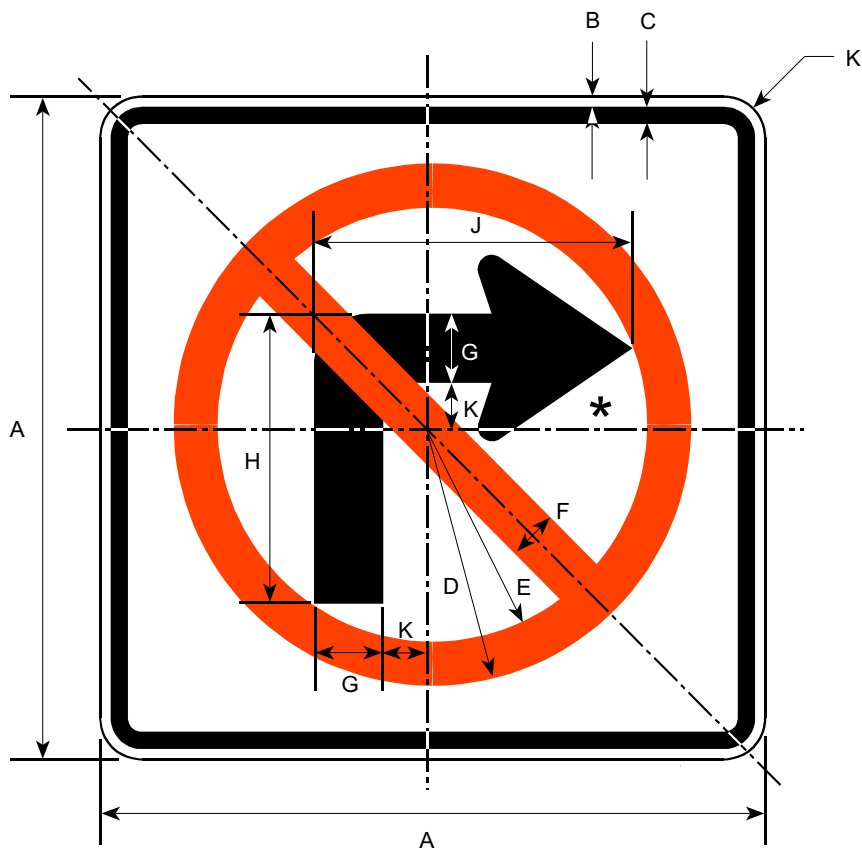

Circle, Diagonal: Red
 Symbol, Border, Legend: Black
 Background: White

*See Appendix B-1 for Standard Arrow Details.

Road Class	Dimensions (inches)									
	A	B	C	D	E	F	G	H	J	K
Minimum	24	0.38	0.63	10.5	8.50	2.0	2.5	10.5	11.5	1.5
Conventional	30	0.50	0.75	13.13	10.63	2.5	3.13	13.13	14.5	1.88
Expressway	36	0.63	0.88	15.75	12.75	3.0	3.75	15.75	17.25	2.25
Oversized	48	0.75	1.25	21	17	4.0	5.0	21	23	3.0

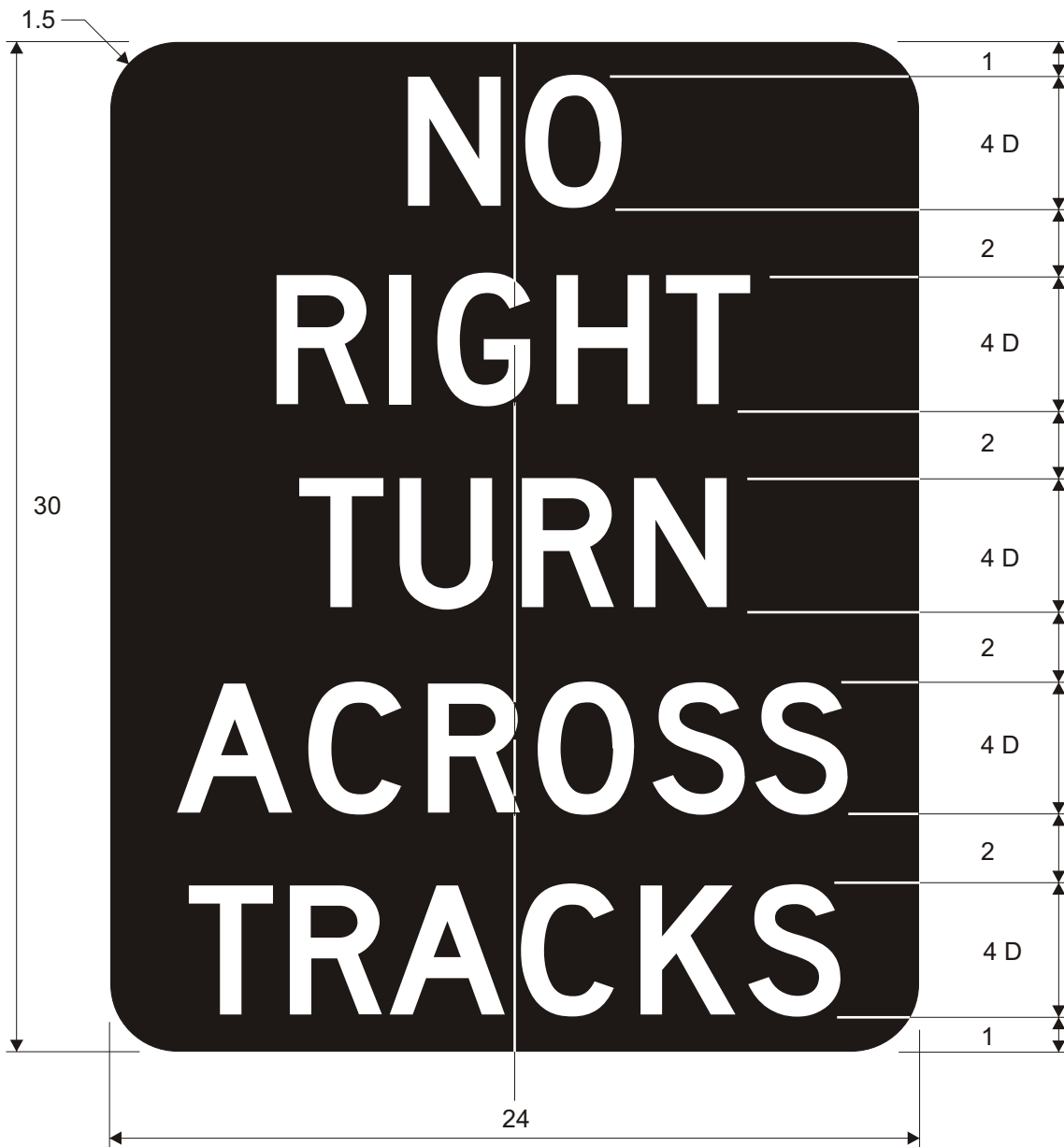

Legend: White
Background: Black

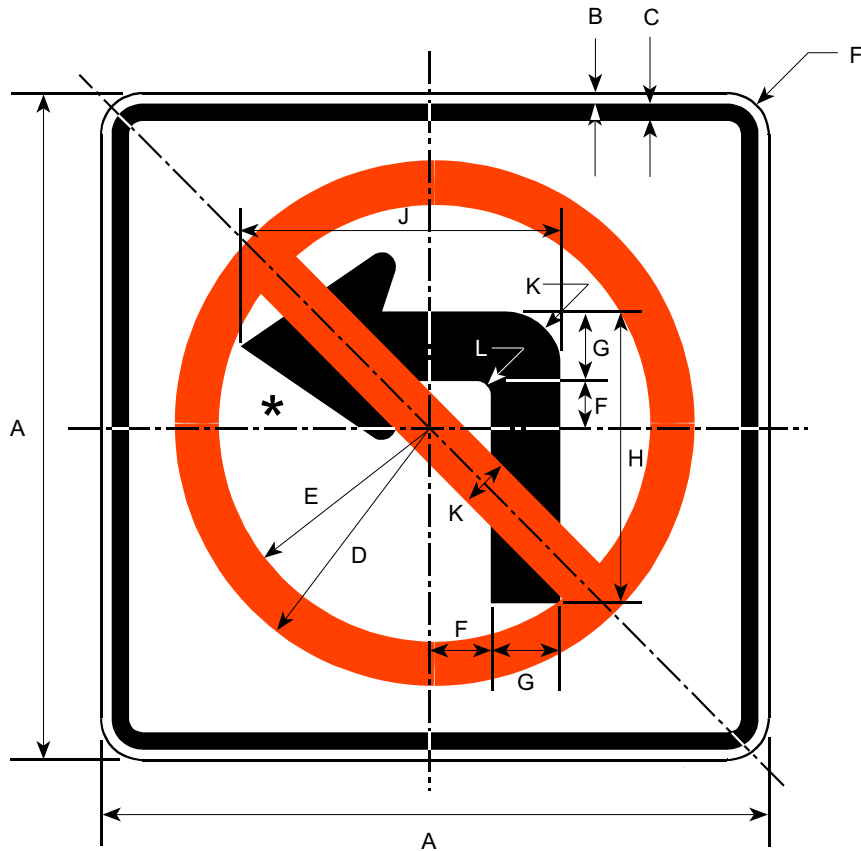

Circle, Diagonal: Red
 Arrow, Border, Legend: Black
 Background: White

*See Appendix B-1 for Standard Arrow Details.

Road Class	Dimensions (inches)										
	A	B	C	D	E	F	G	H	J	K	L
Minimum	24	0.38	0.63	10.5	8.5	1.5	2.5	10.5	11.5	2.0	0.5
Conventional	30	0.50	0.75	13.13	10.63	1.88	3.13	13.13	14.5	2.5	0.63
Expressway	36	0.63	0.88	15.75	12.75	2.25	3.75	15.75	17.25	3.0	0.75
Oversized	48	0.75	1.25	21	17	3.0	5.0	21	23	4.0	1.0

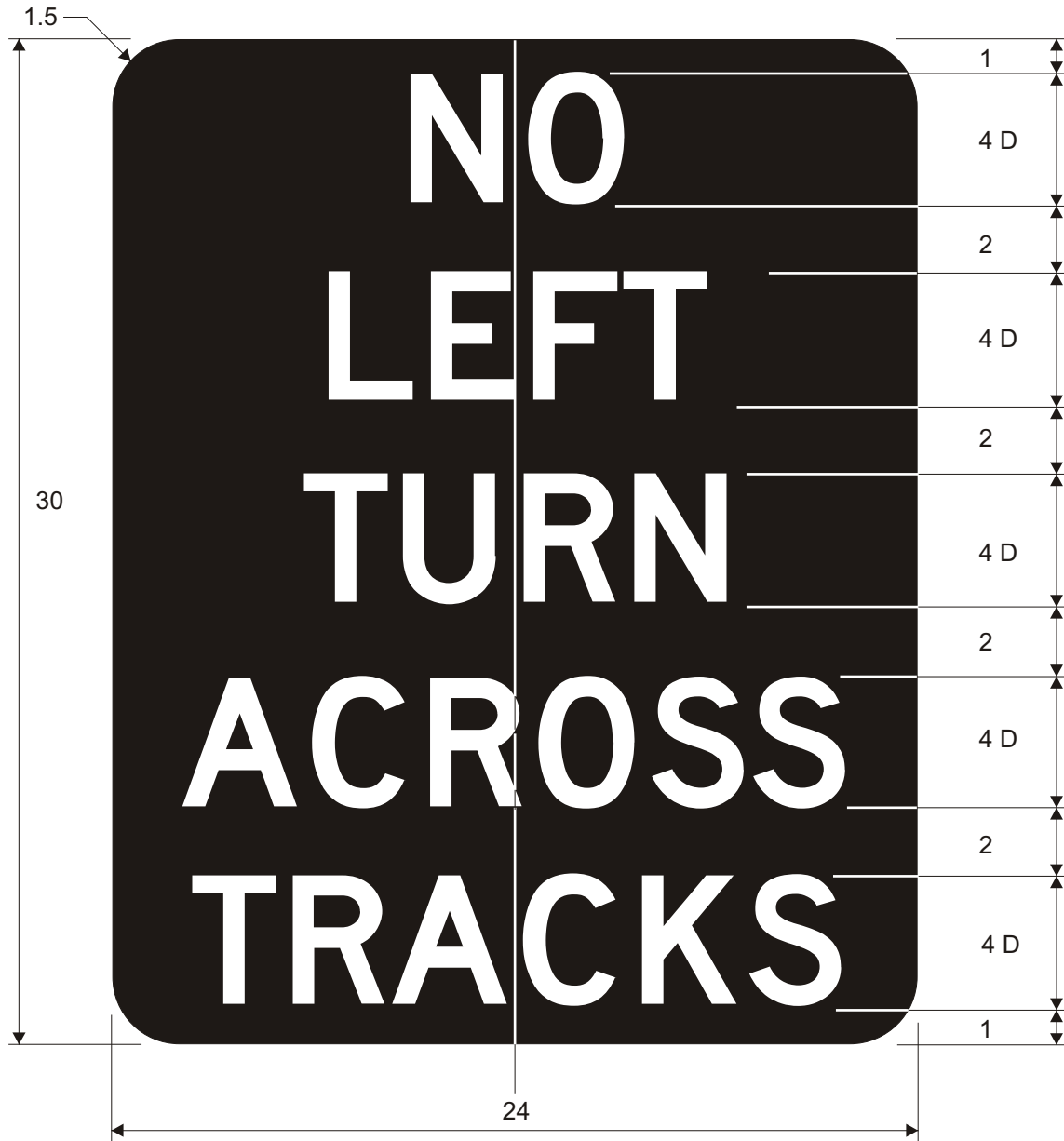

Legend: White
Background: Black

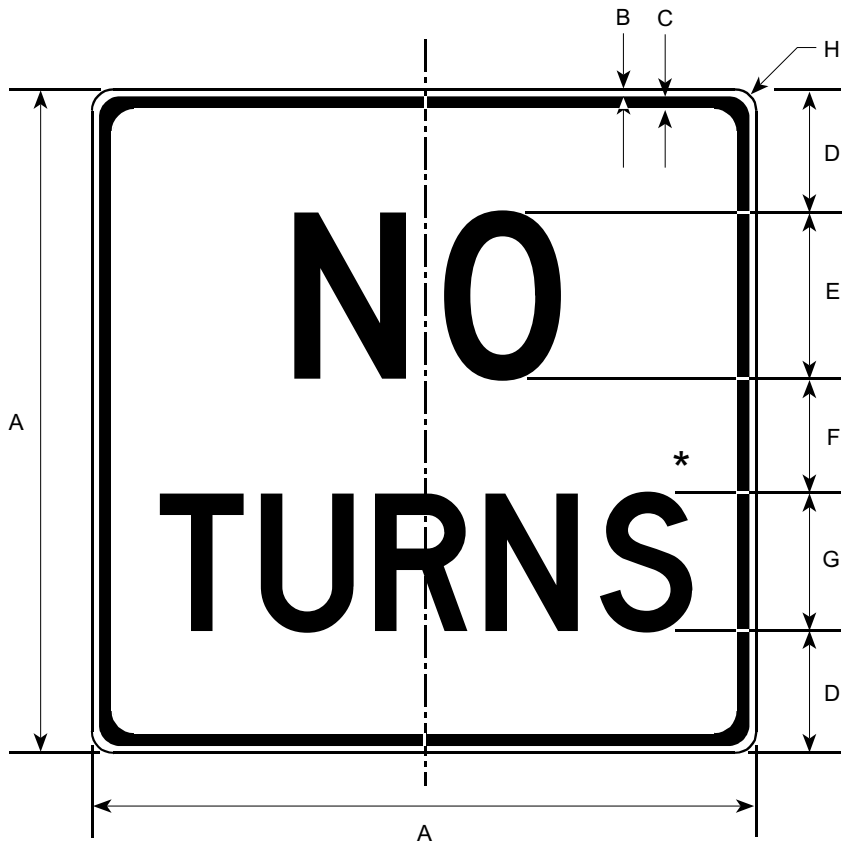

Border and Legend: Black
 Background: White

* Reduce letter spacing 35%.

Road Class	Dimensions (inches)							
	A	B	C	D	E	F	G	H
Minimum	24	0.38	0.63	4.5	6D	4.0	5D	1.5
Conventional	30	0.50	0.75	5.5	8D	5.0	6D	1.88
Expressway	36	0.63	0.88	6.0	10D	6.0	8D	2.25
Oversized	48	0.75	1.25	9.0	12D	8.0	10D	3.0

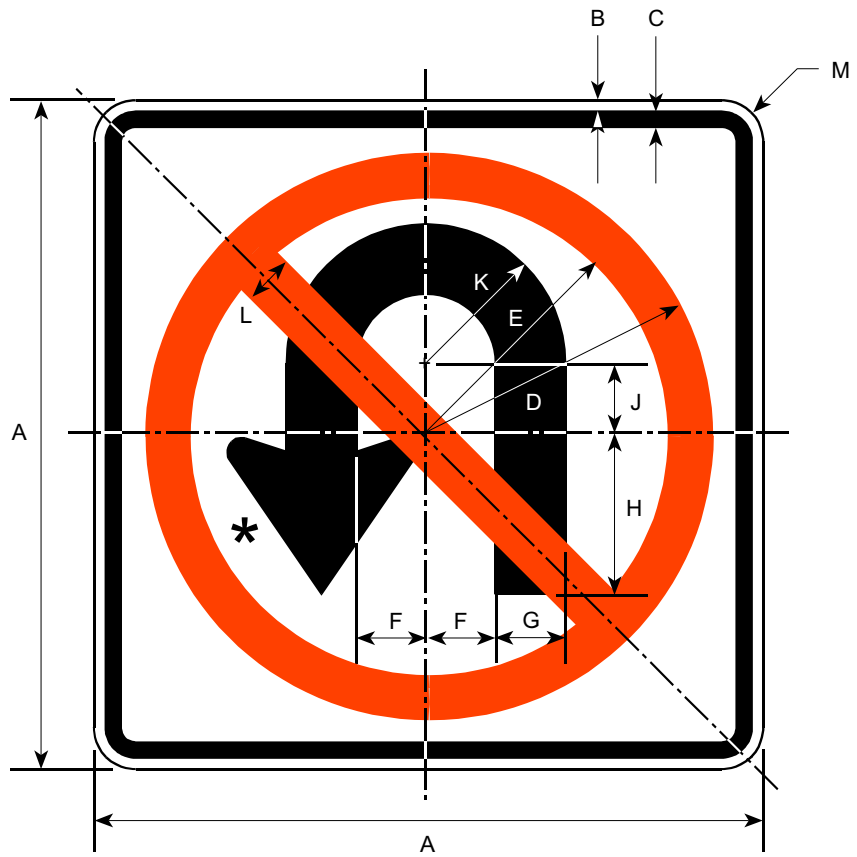

Circle, Diagonal: Red
 Arrow, Border, Legend: Black
 Background: White

*See Appendix B-1 for Standard Arrow Details.

Road Class	Dimensions (inches)											
	A	B	C	D	E	F	G	H	J	K	L	M
Minimum	24	0.38	0.63	10.5	8.5	2.5	2.5	6.0	2.25	5.0	2.0	1.5
Conventional	30	0.50	0.75	13.13	10.63	3.13	3.13	7.5	2.81	6.25	2.5	1.88
Expressway	36	0.63	0.88	15.75	12.75	3.75	3.75	9.0	3.38	7.5	3.0	2.25
Oversized	48	0.75	1.25	21	17	5.0	5.0	12	4.5	10	4.0	3.0

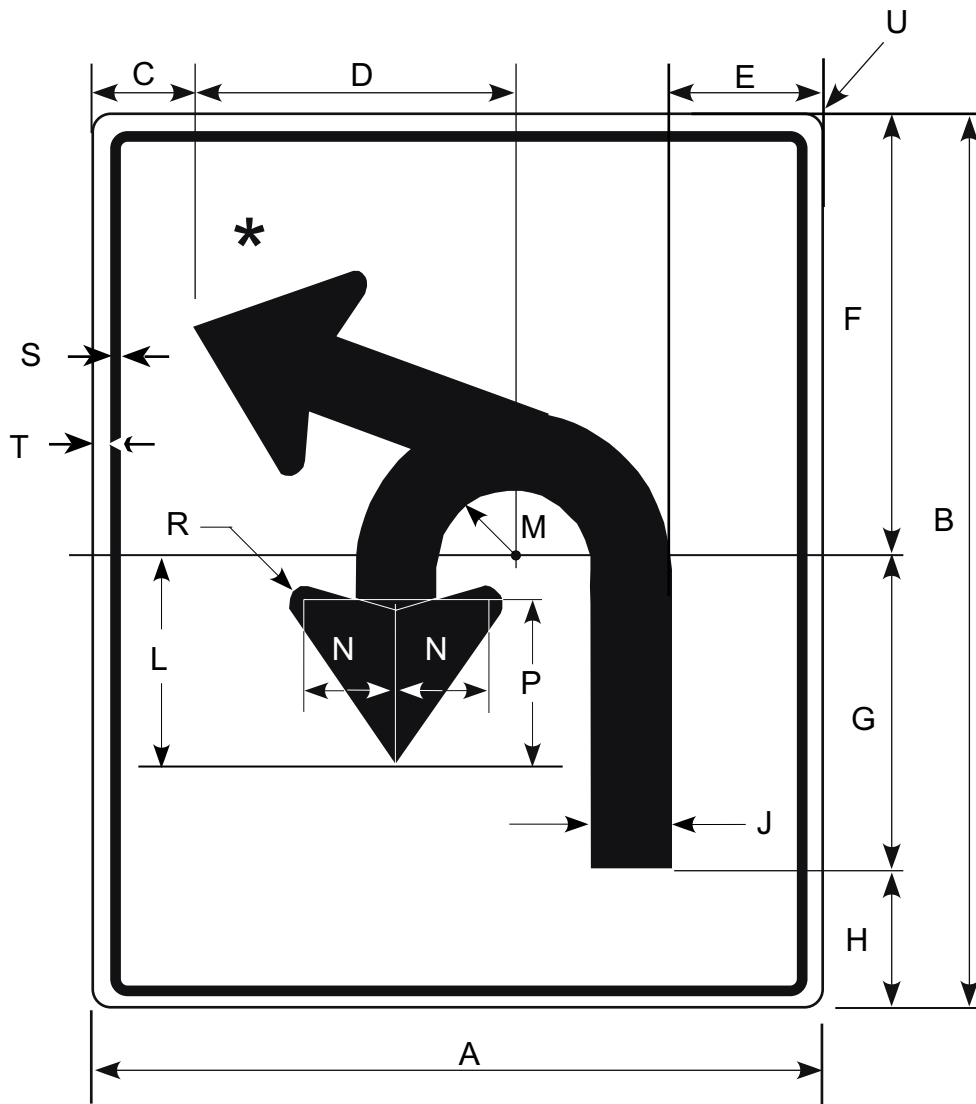

Border and Legend: Black
Background: White

*See Appendix B-1 for Standard Arrow Details.

Road Class	Dimensions (inches)									
	A	B	C	D	E	F	G	H	J	L
Std & Conv	30	36	4.0	13	6.25	18	12.5	5.5	3.75	8.0
	M	N	P	R	S	T	U			
	4	3.63	6.38	0.63	1.88	0.50	0.75			

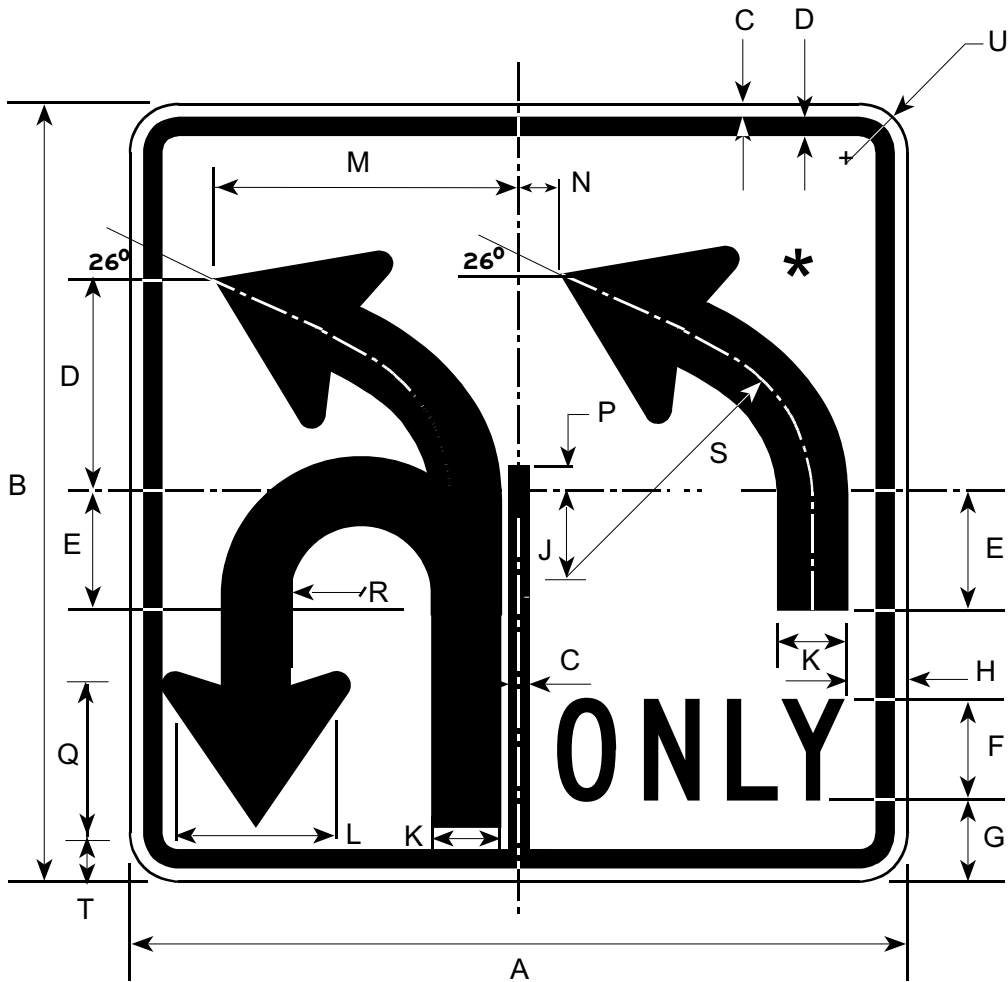

Border and Legend: Black
Background: White

*See Appendix B-1 for Standard Arrow Details.

Road Class	Dimensions (inches)										
	A	B	C	D	E	F	G	H	J	K	L
Conventional	48	36	0.8	1.3	6.4	6D	3.6	3.2	2.88	3.13	7.25
	M	N	P	Q	R	S	T	U			
	19	4.0	2.0	6.38	3.6	12	2.81	2.5			

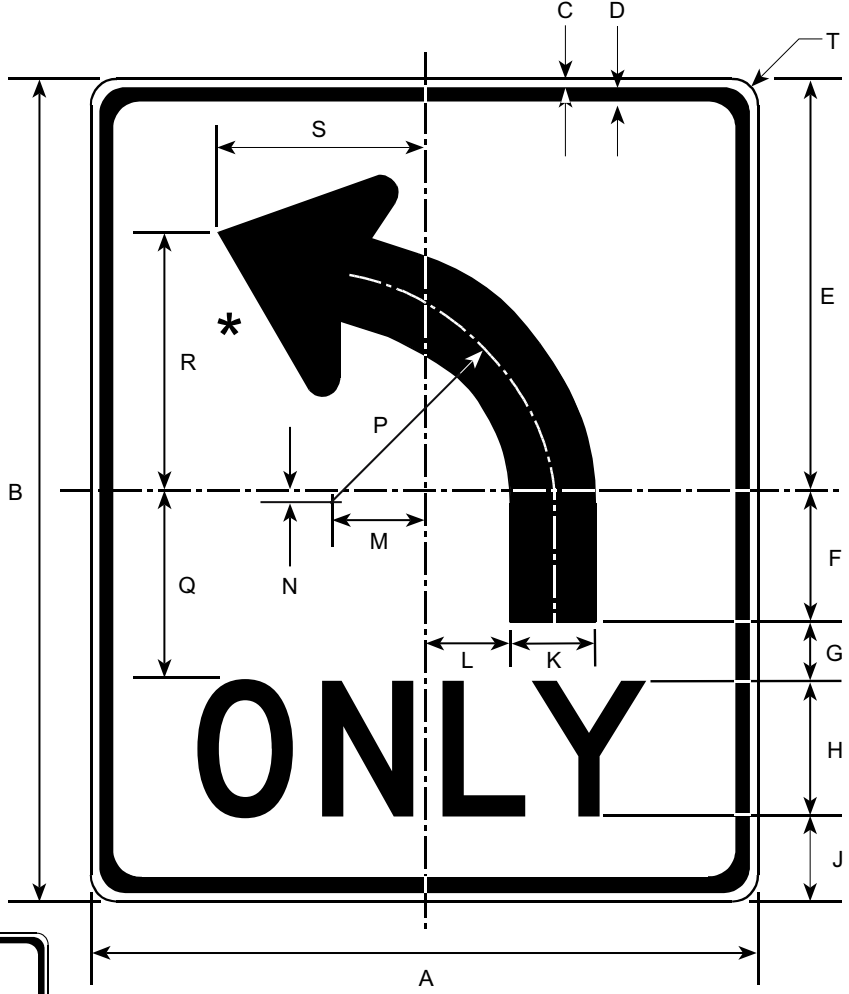

R3-5L

Border and Legend: Black
Background: White

*See Appendix B-1 for Standard Arrow Details.



R3-5R

Road Class	Dimensions (inches)										
	A	B	C	D	E	F	G	H	J	K	L
Minimum (Ground Mount Only)	24	30	0.38	0.63	15	4.75	2.0	5D	3.25	3.25	3.3
Conventional	30	36	0.50	0.75	18	5.75	2.5	6D	3.75	3.75	3.88

M	N	P	Q	R	S	T
3.25	0.4	7.88	6.85	9.35	7.5	1.5
3.75	0.5	9.5	8.25	11.25	9.25	1.88

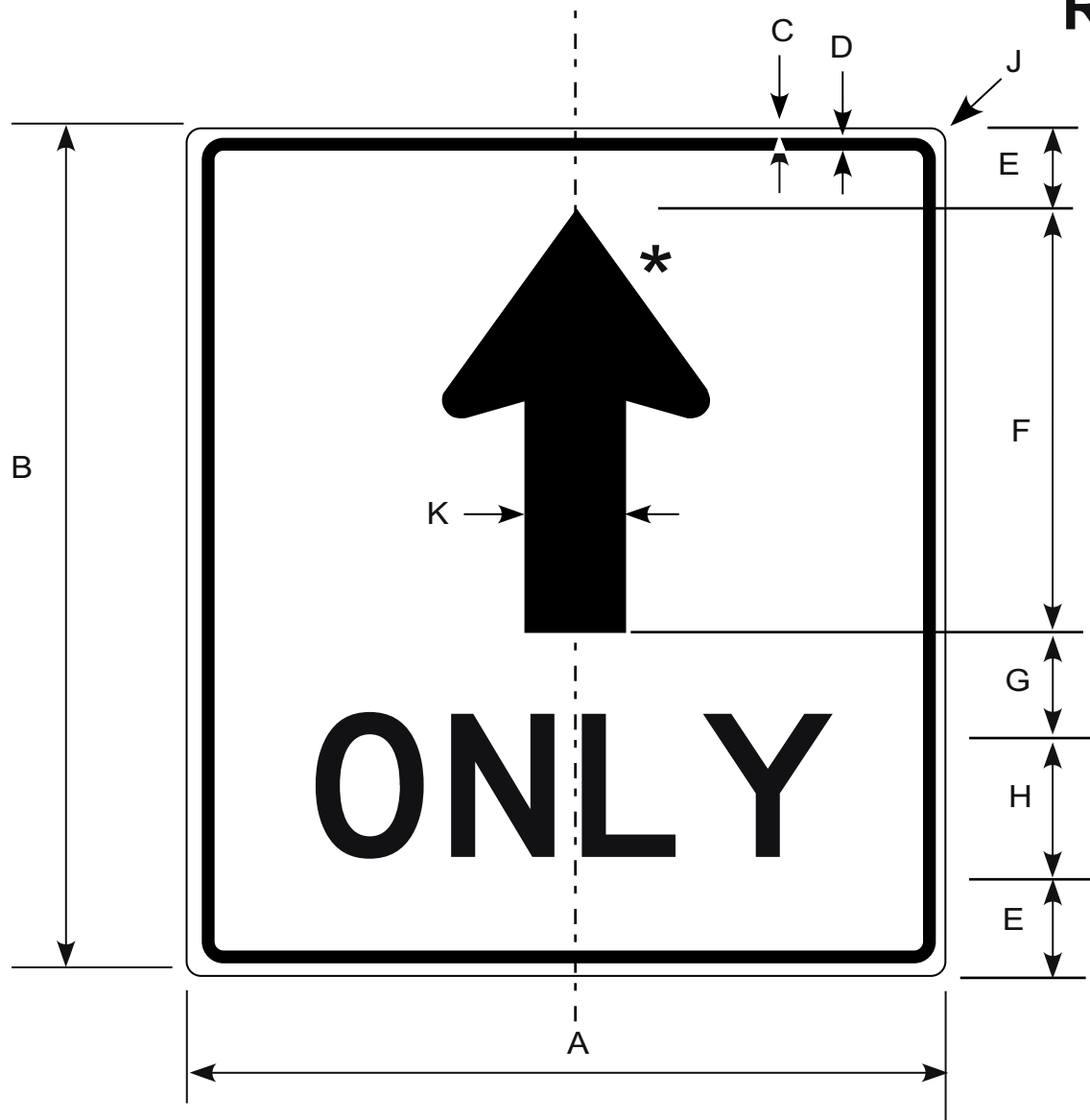

Border, Symbol, and Legend: Black
Background: White

*See Appendix B-1 for Standard Arrow Details.

Dimensions (inches)										
A	B	C	D	E	F	G	H	J	K	
30	36	0.50	0.75	3.75	18	4.50	6D	1.88	3.75	

R3-5B
 R3-5C
 R3-5D
 R3-5E
 R3-5F
 R3-5G

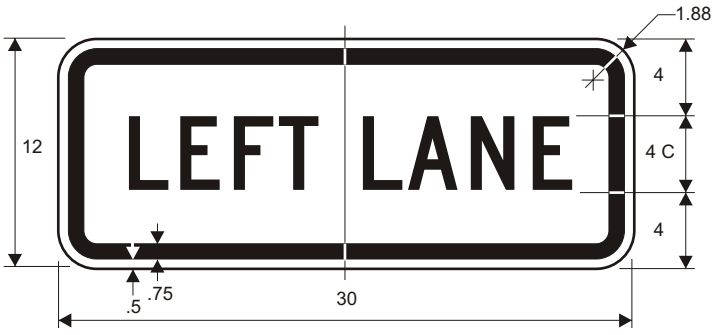

R3-5B

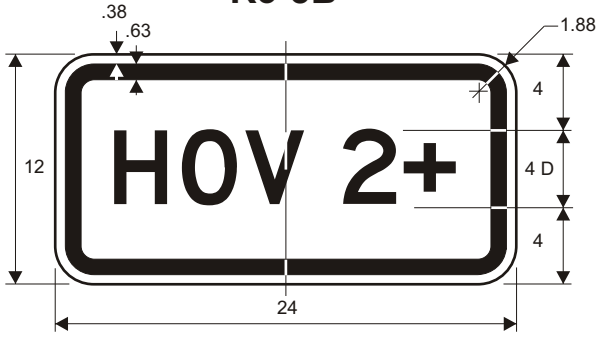

R3-5C

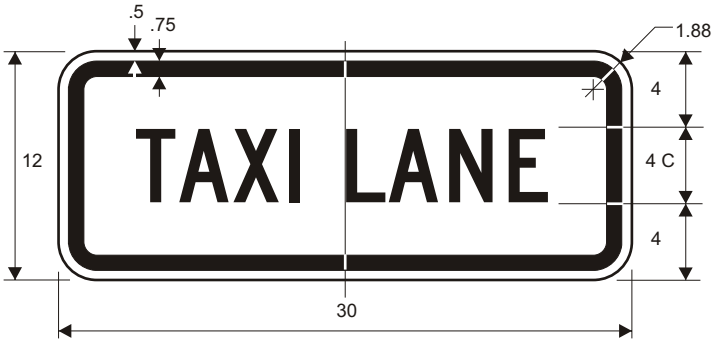

R3-5D

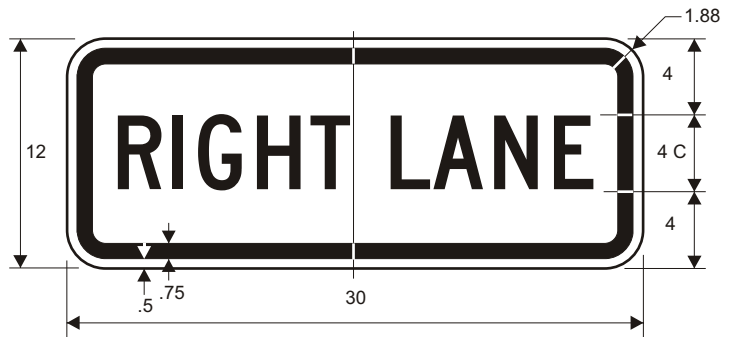

R3-5F

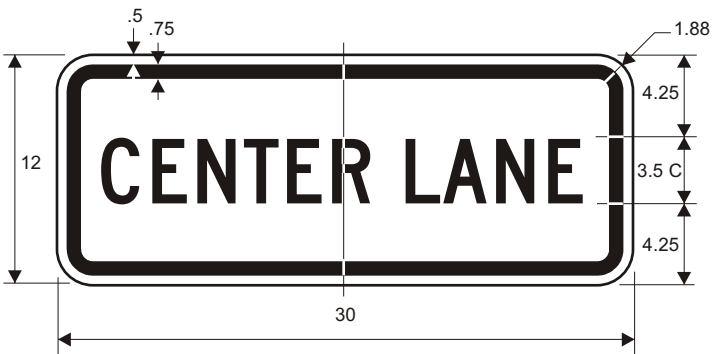

R3-5E

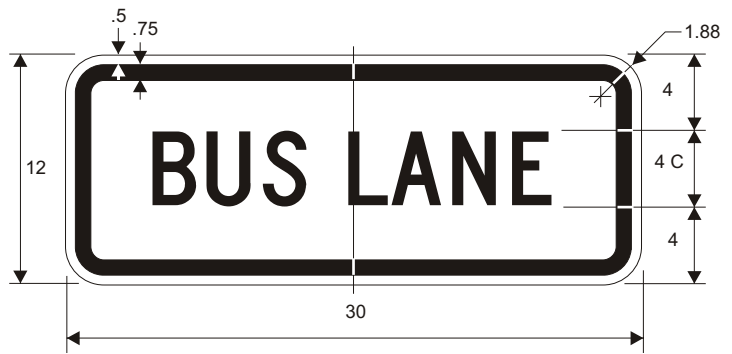

R3-5G

Legend: Black
 Background: White

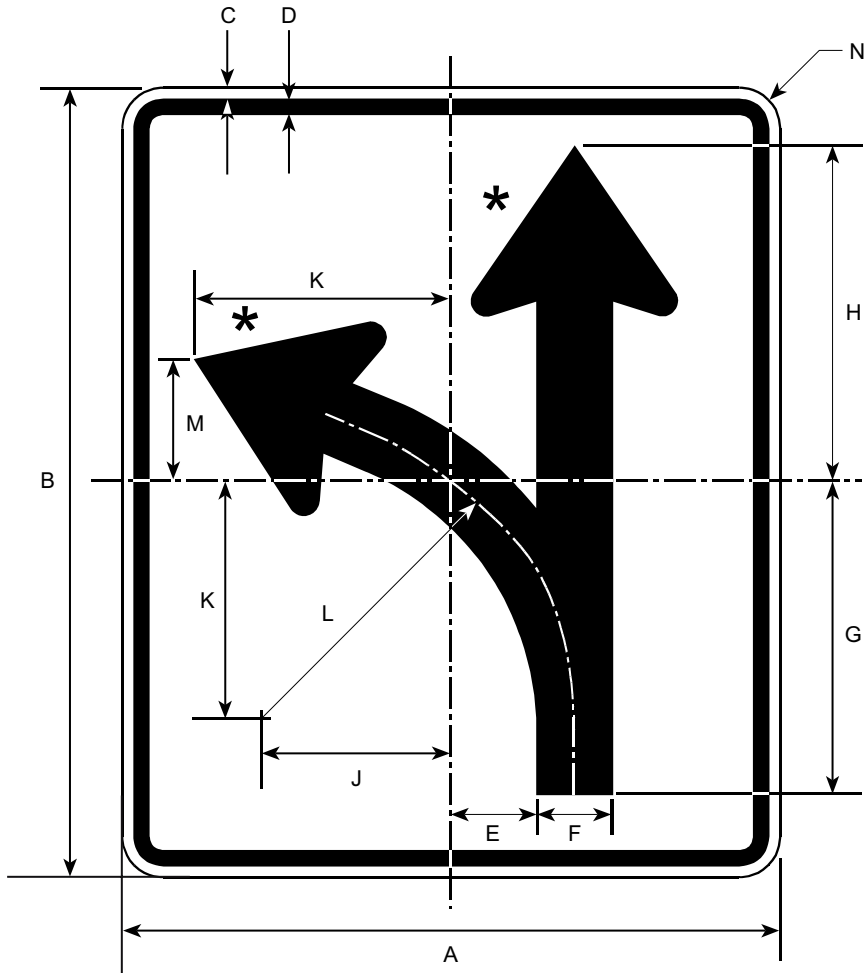

Border and Legend: Black
 Background: White

*See Appendix B-1 for Standard Arrow Details.

Prior to the 2002 publication of this manual, this sign was numbered R3-6SL.

Road Class	Dimensions (inches)												
	A	B	C	D	E	F	G	H	J	K	L	M	N
Conv & Min	30	36	0.50	0.75	3.88	3.50	14.25	15.38	8.88	11.75	14.50	5.63	1.88

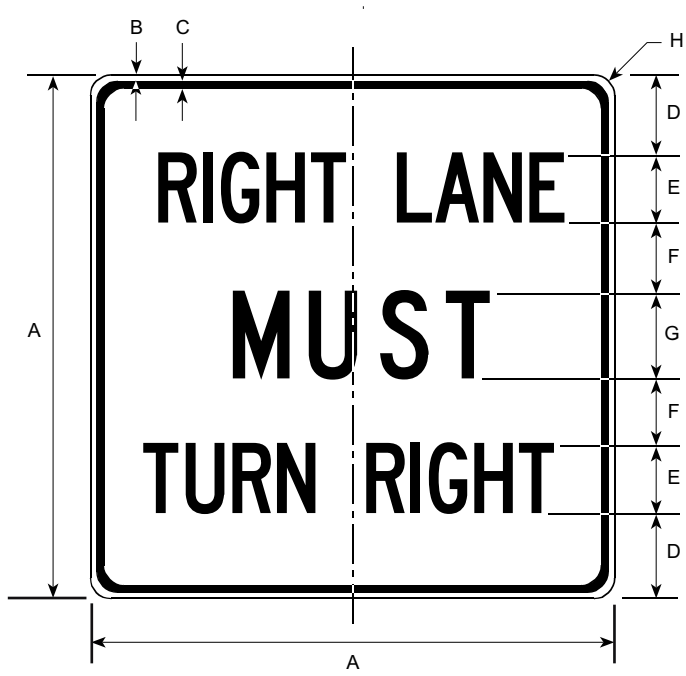

R3-7R



R3-7L

Border and Legend: Black
Background: White







Road Class	Dimensions (inches)							
	A	B	C	D	E	F	G	H
Minimum	30	0.50	0.75	4.5	4C	4.0	5C	1.88
Conventional	36	0.63	0.88	5.5	5C	4.5	6C	2.25
Expressway	48	0.75	1.25	8.0	6C	6.0	8C	3.0

R3-8 Options

Multiple lane use control signs (R3-8s) may be specified with legends other than those illustrated on the following pages.

All R3-8 signs shall have black legends on white backgrounds.

Movements may be signified with the following suffixes:

Movement:	 ONLY	 ONLY	 ONLY			
Suffix:	L	S	R	SL	SR	LR

For example, a sign indicating a restricted left turn lane, a left or through center lane, and a restricted right turn lane would appear as follows:

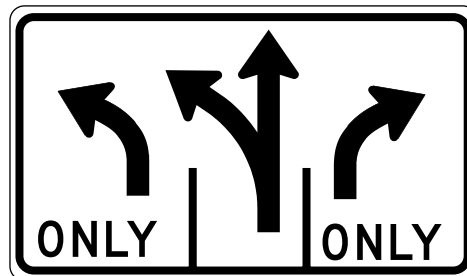

R3-8L/SL/R

R3-8 L/LR

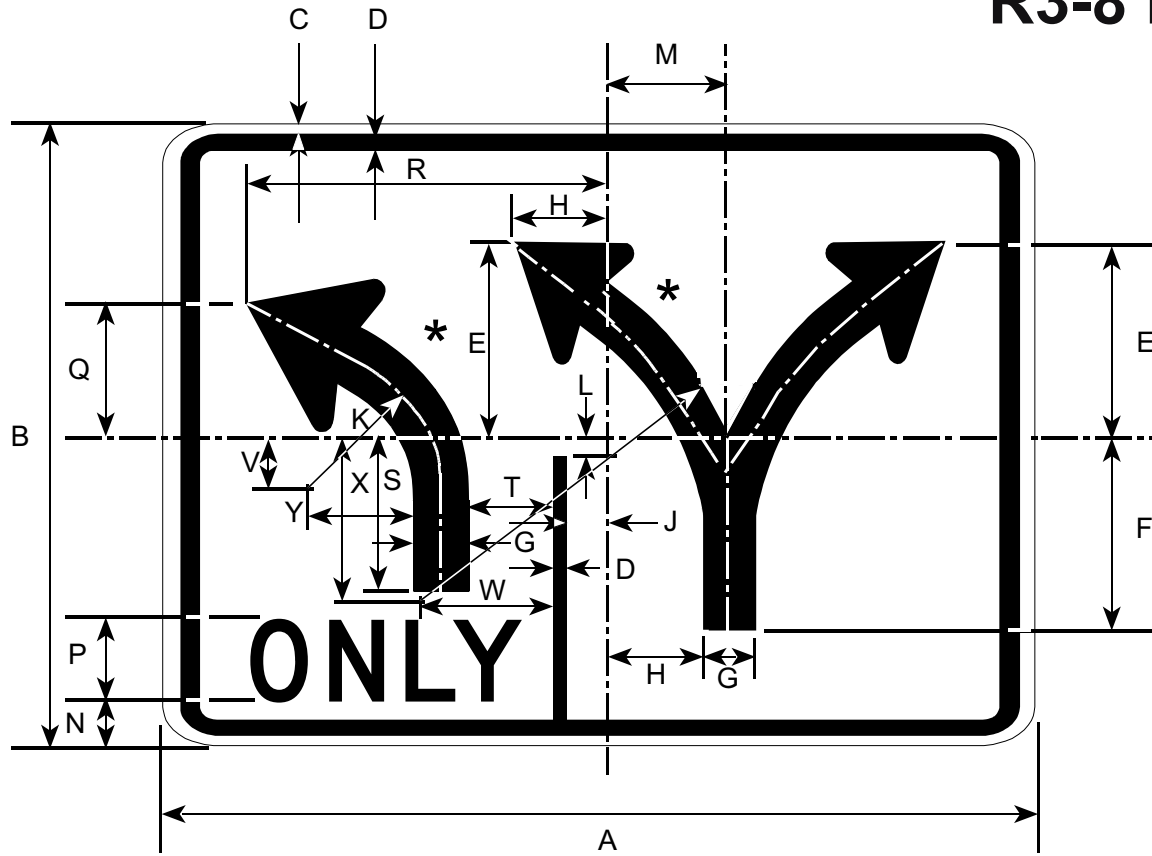

Border and Legend: Black
Background: White

*See Appendix B-1 for Standard Arrow Details.

Prior to 2002 publication of this manual, this sign was numbered R3-8L/DT.

Road Class	Dimensions (inches)												
	A	B	C	D	E	F	G	H	J	K	L	M	N
Conv&Min	36	30	0.5	0.75	8.0	10.25	2.5	4.0	1.75	5.75	1.0	5.25	3.0
	P	Q	R	S	T	V	W	X	Y	Z			
	4D	5.0	15	6.5	3.25	2.63	5.25	7.5	4.5	14.5			

R3-8 L/S

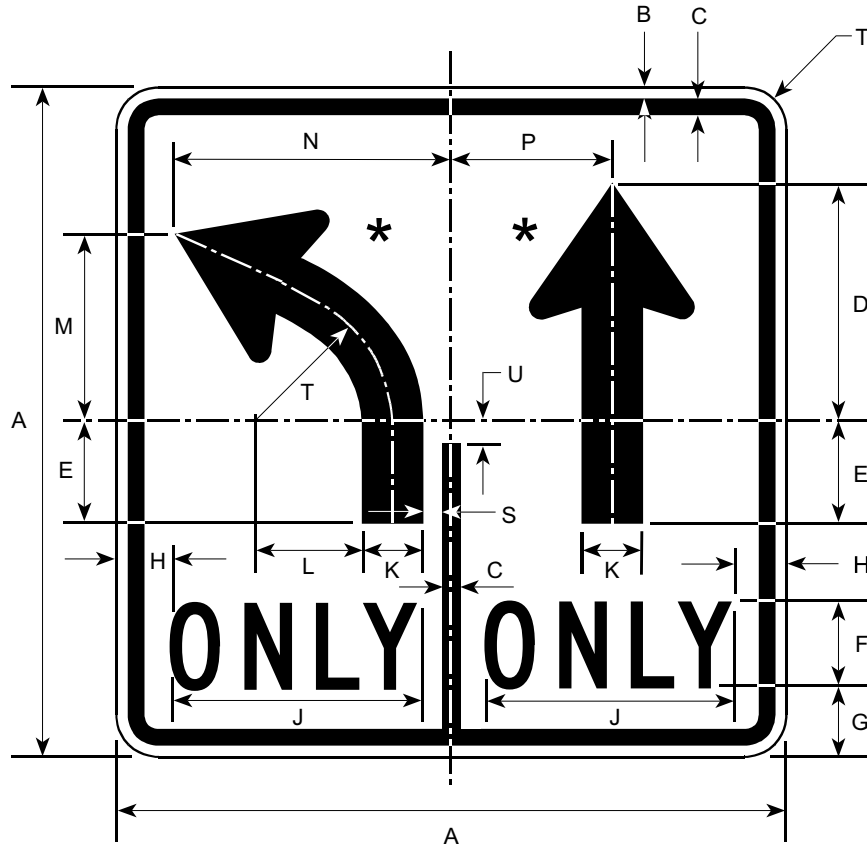

Border and Legend: Black
Background: White

*See Appendix B-1 for Standard Arrow Details.

Road Class	Dimensions (inches)																
	A	B	C	D	E	F	G	H	J	K	L	M	N	P	S	T	U
Conv&Min	30	0.5	0.75	9.06	3.94	4C	3.0	2.56	11.13	2.50	4.50	8.0	11.94	6.88	1.56	1.88	1.0

R3-8 L/SL

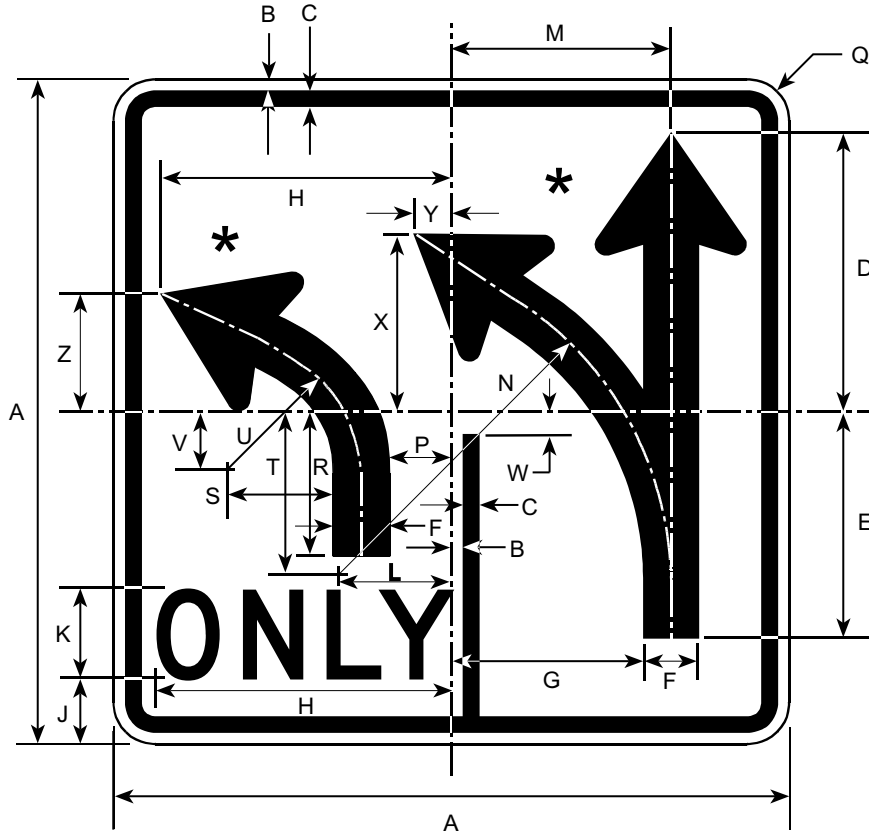

Border and Legend: Black
Background: White

*See Appendix B-1 for Standard Arrow Details.

Road Class	Dimensions (inches)																	
	A	B	C	D	E	F	G	H	J	K	L	M	N	P	Q	R	S	T
Conv&Mn	30	0.50	0.75	12.6	10.25	2.5	8.50	12.88	3.0	4D	4.75	9.75	14.5	2.75	1.9	6.50	4.50	7.5
Expwy	48	0.75	1.25	20.0	16.38	4.0	13.6	20.63	5.0	6D	7.63	15.63	23.3	4.38	3.0	10.38	7.19	12.0

U	V	W	X	Y	Z
5.75	2.63	1.00	8.00	1.75	5.0
9.25	4.25	1.63	12.75	2.75	8.0

R3-9A

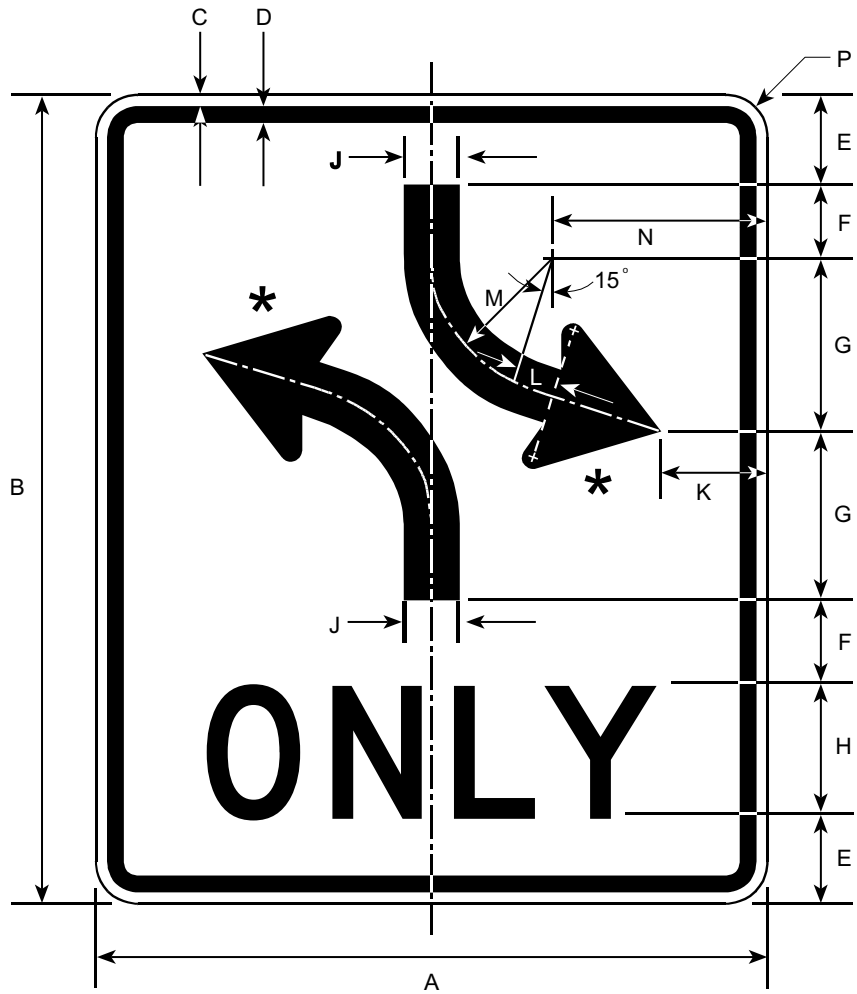

Border and Legend: Black
Background: White

*See Appendix B-1 for Standard Arrow Details.

Road Class	Dimensions (inches)														
	A	B	C	D	E	F	G	H	J	K	L	M	N	P	
Conv & Min	30	36	0.50	0.75	4.0	3.0	8.0	6D	2.5	4.0	1.5	6.0	9.0	1.88	
Expressway	48	60	1.25	0.75	7.0	5.0	13	10D	4.0	6.5	2.38	9.5	14.5	3.0	

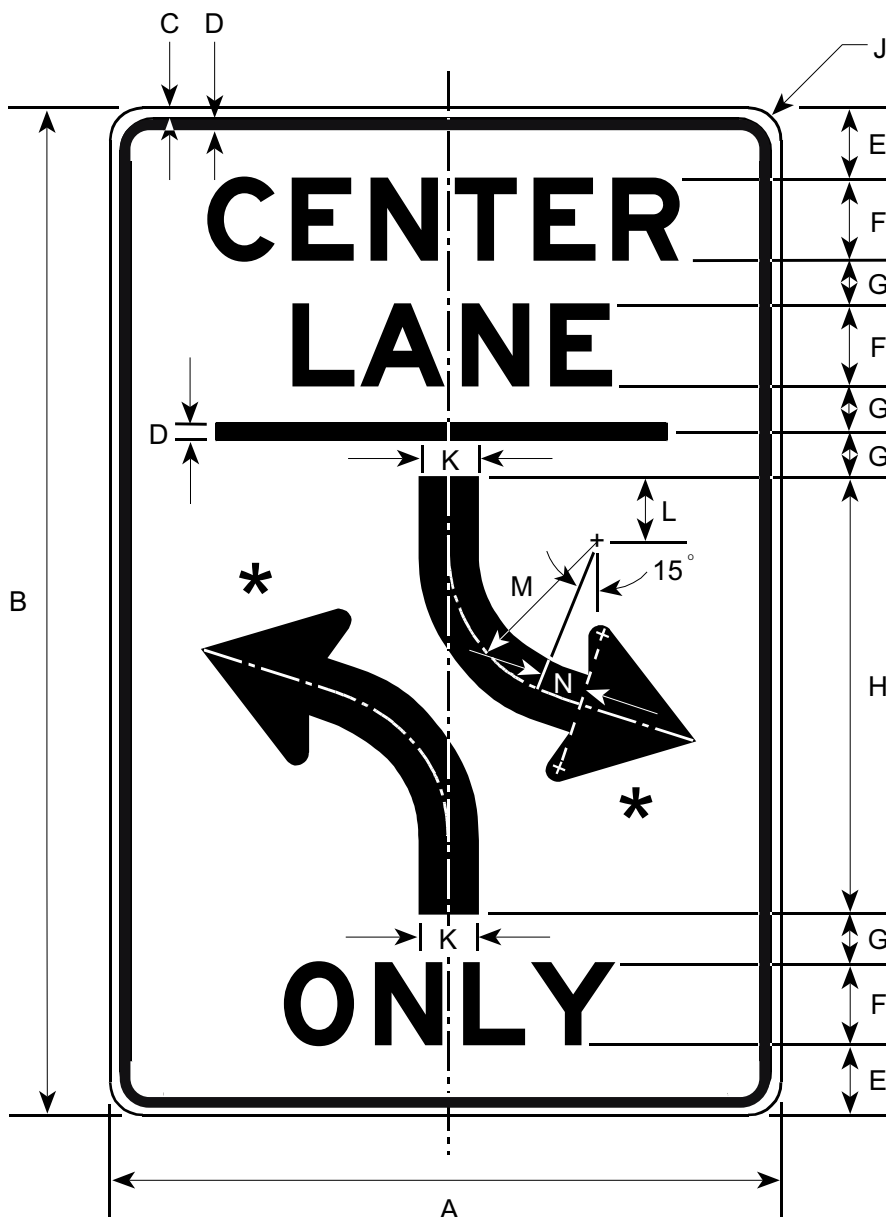

Border and Legend: Black
Background: White

*See Appendix B-1 for Standard Arrow Details.

Road Class	Dimensions (inches)												
	A	B	C	D	E	F	G	H	J	K	L	M	N
Conv & Min	24	36	0.38	0.63	2.5	3E	1.5	16	1.50	2.0	2.5	6.0	1.5
Expressway	36	48	0.63	0.88	3.5	5E	1.5	20	2.25	3.0	3.0	8.0	2.0

R3-9D

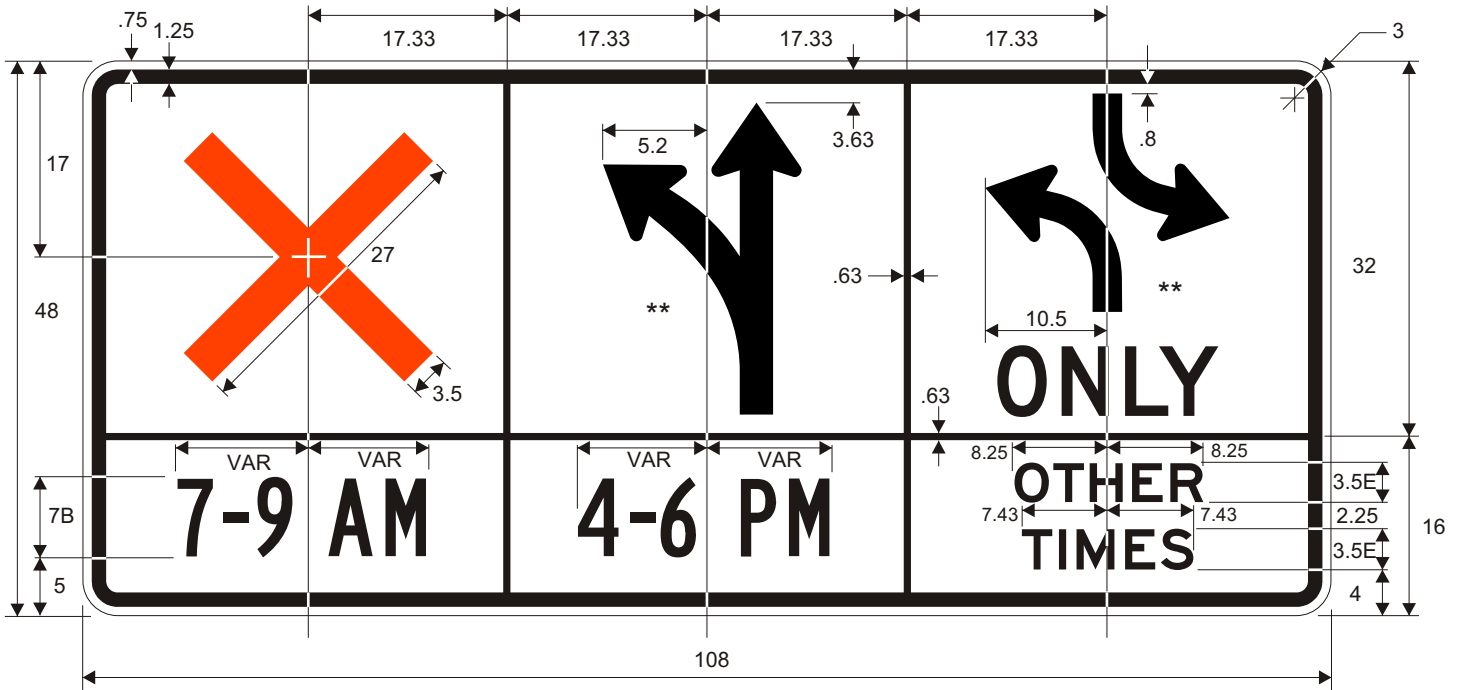

*Insert R3-8a, increase 17% to fit.
 **Insert R3-9a.

Border and Legend: Black
 Symbols: Black
 Exclusion: Red
 Background: White

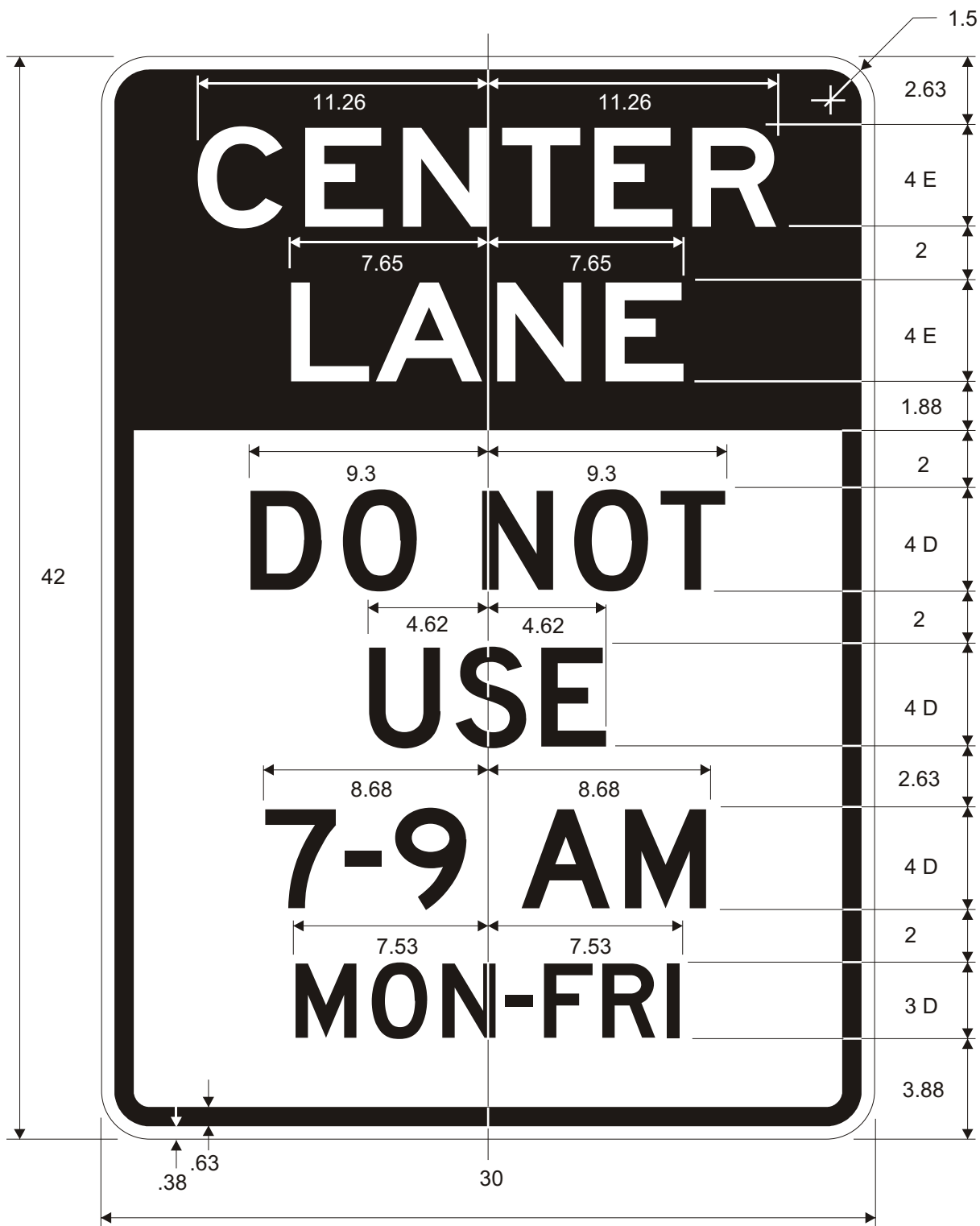

Top:
 Legend: White
 Background: Black

Bottom:
 Border and Legend: Black
 Background: White

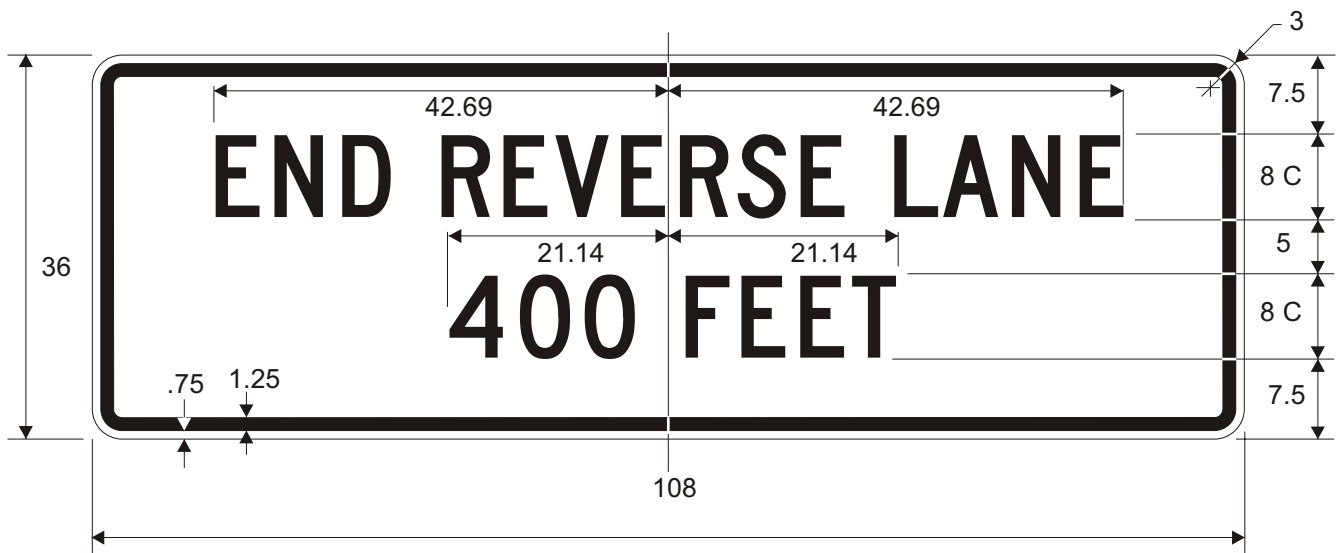
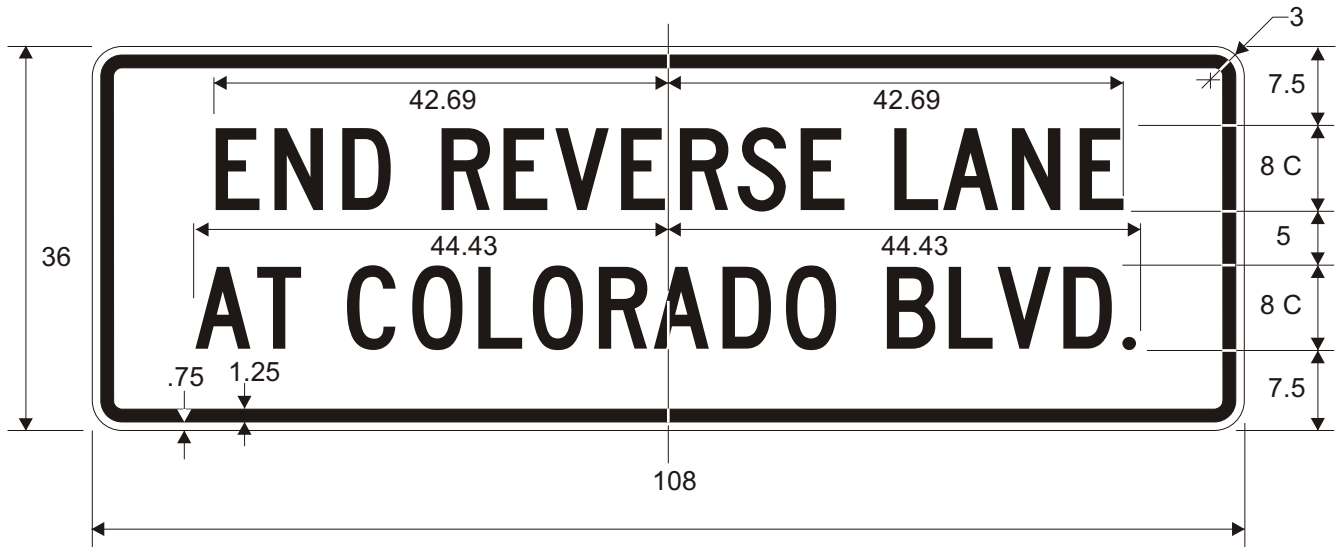

Border and Legend: Black
Background: White

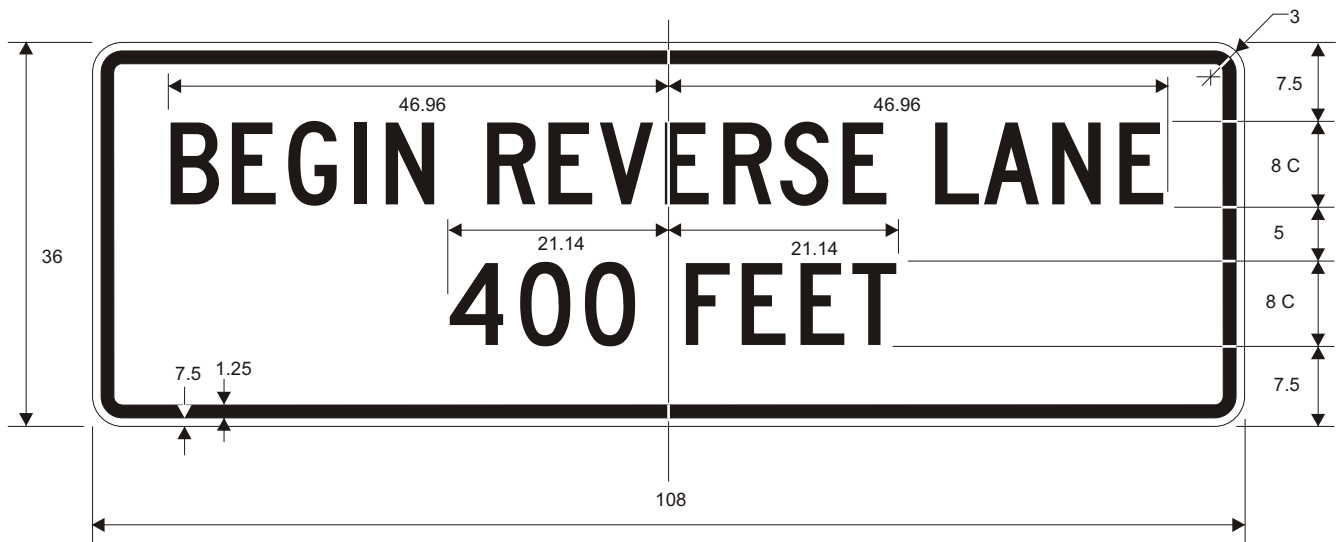
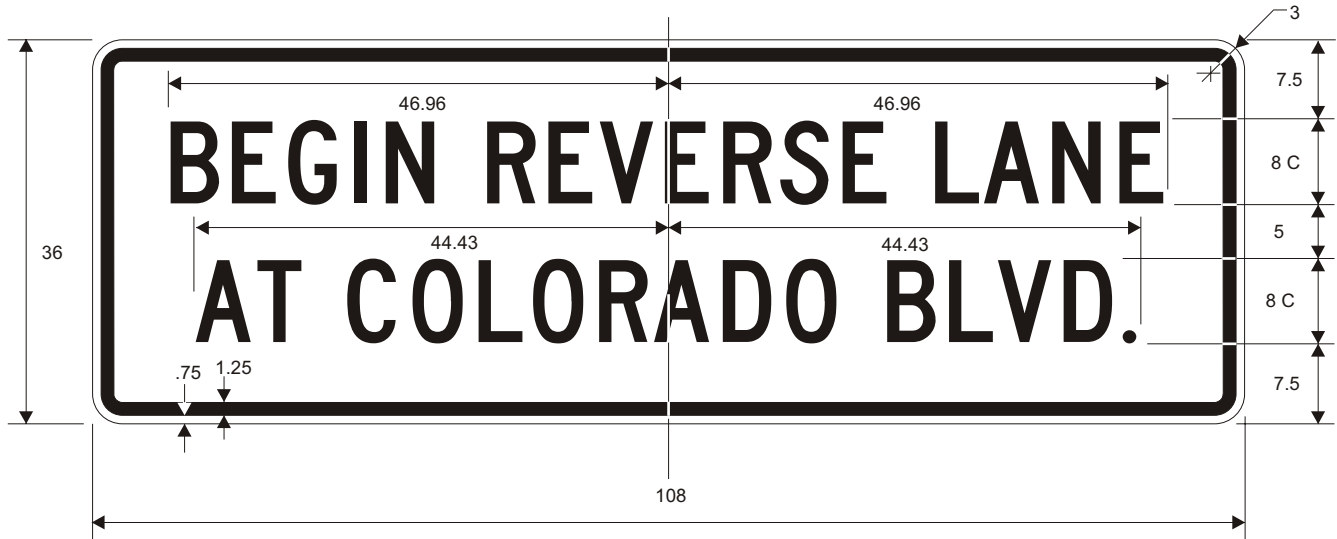

Border and Legend: Black
Background: White

R3-9I

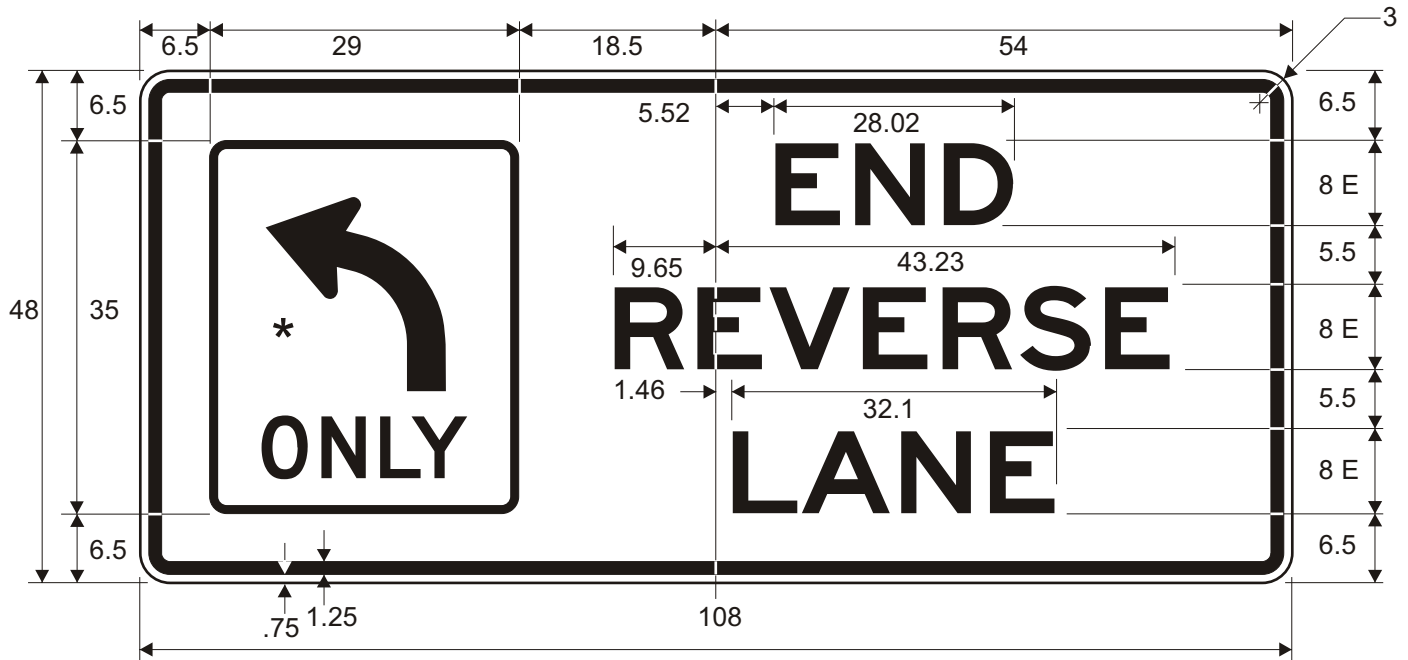

*Insert R3-5.

Border and Legend: Black
Background: White

R3-10A

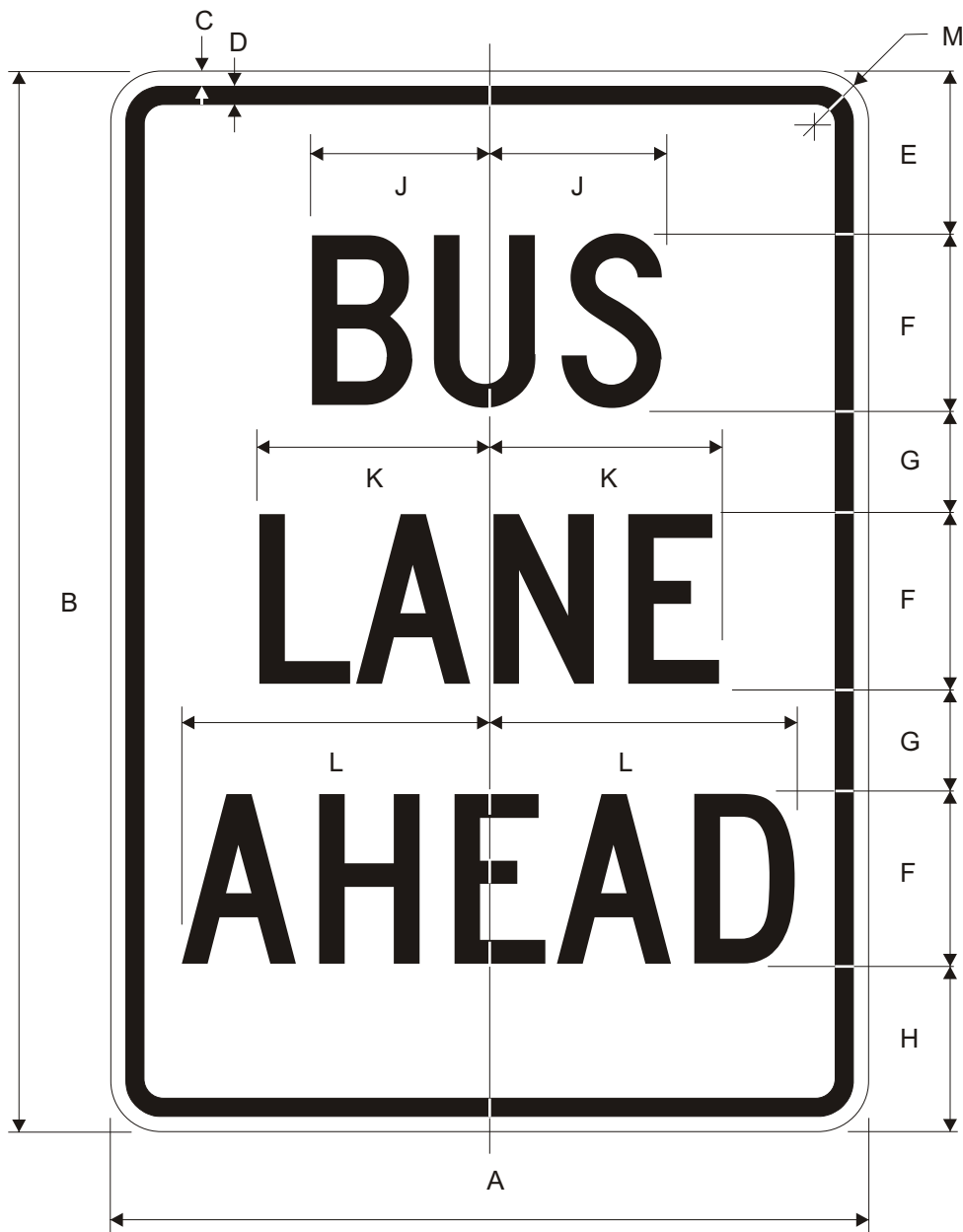

Road Class	Dimensions (inches)											
	A	B	C	D	E	F	G	H	J	K	L	M
Conv	30	42	0.5	0.75	6.5	7C	4	6.5	7.05	9.21	12.21	1.88
Expy	36	60	0.63	0.88	10	8C	8	10	8.04	10.50	13.94	2.25
Fwy	78	96	1	1.25	13	16C	11	13	16.08	21.01	27.89	3

Border and Legend: Black
Background: White

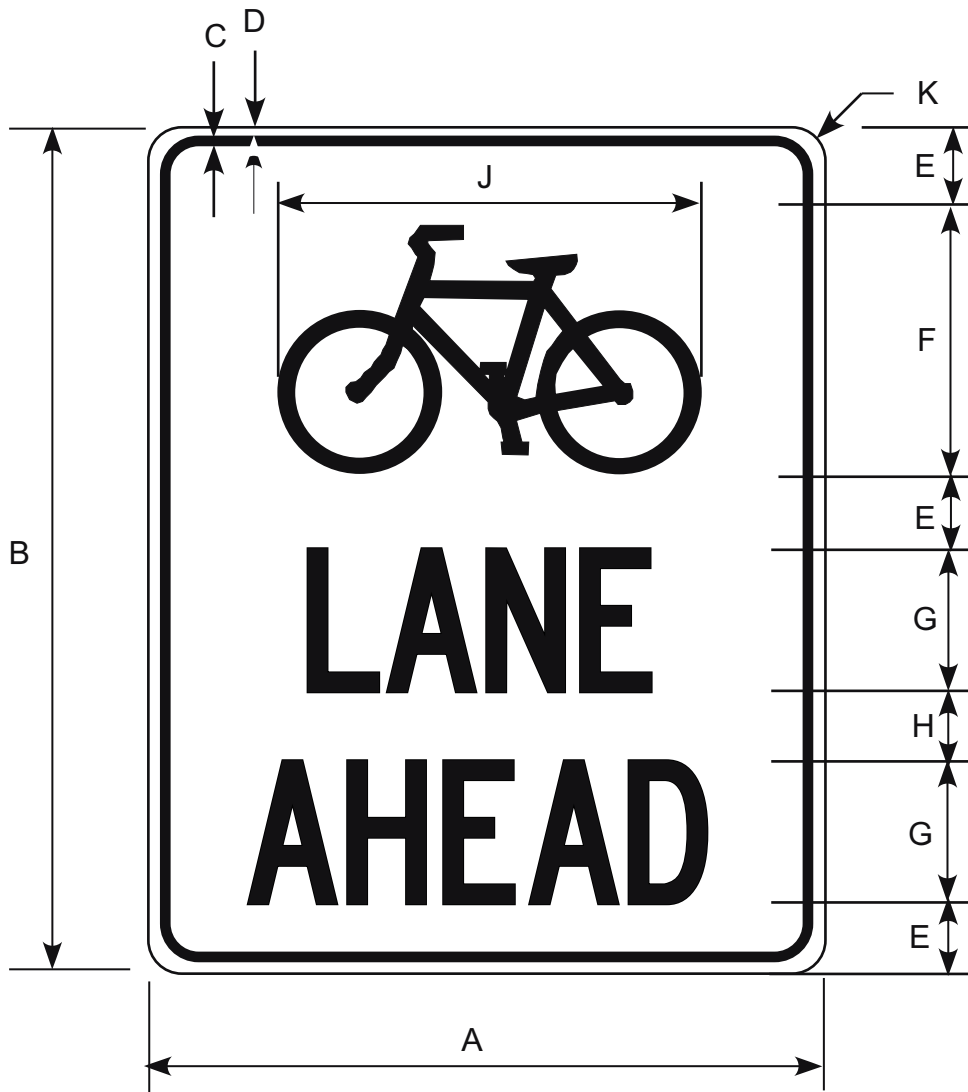

Border, Symbol, and Legend: Black
 Background: White

Make symbol proportional
 to the one shown.

Road Class	Dimensions (inches)									
	A	B	C	D	E	F	G	H	J	K
Conv & Min	24	30	0.63	0.38	3.5	7	5C	2.5	14	1.5

R3-16A

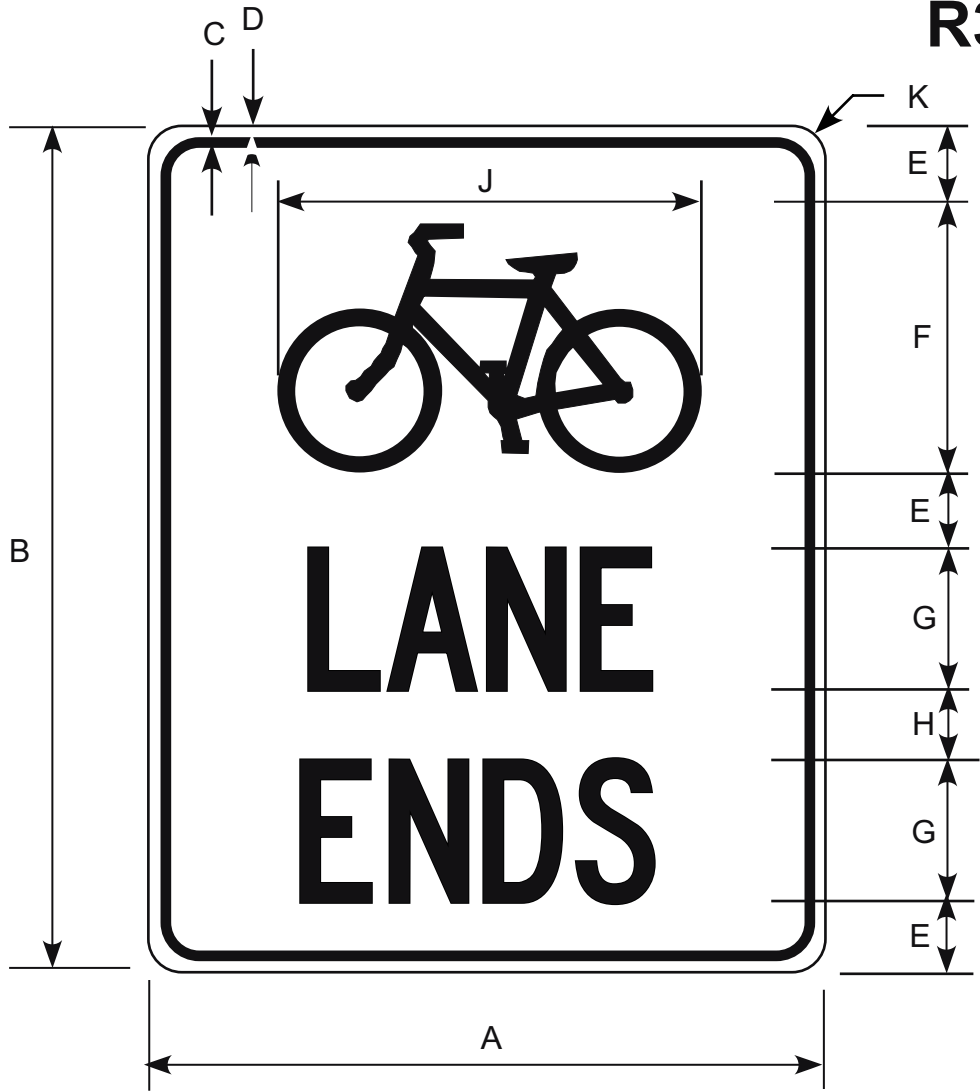

Border, Symbol, and Legend: Black
Background: White

Make symbol proportional
to the one shown.

Road Class	Dimensions (inches)									
	A	B	C	D	E	F	G	H	J	K
Conv & Min	24	30	0.63	0.38	3.5	7	5C	2.5	14	1.5



Circle and Diagonal: Red
 Border and Symbol: Black
 Background: White

*See Appendix B-1 for Standard Arrow Details.

Road Class	Dimensions (inches)										
	A	B	C	D	E	F	G	H	J	K	L
Minimum	24	0.38	0.63	10.41	8.57	2.08	3.68	1.84	6.81	0.4	1.58
Conventional	30	0.5	0.75	13	10.73	2.6	4.6	2.28	8.53	0.48	1.8
Expwy/Fwy	36	0.63	0.88	15.61	12.89	3.12	5.52	2.72	10.25	0.56	2.16
Oversized	48	0.75	1.25	20.82	17.13	4.16	7.37	3.68	13.61	0.8	2.88

M	N	P	Q	R	S
4.32	2.24	2.92	1.60	8.09	1.5
5.40	2.8	3.64	2.0	10.09	1.88
6.48	3.36	4.36	2.4	12.09	2.25
8.65	4.48	5.84	3.2	16.172	3.0

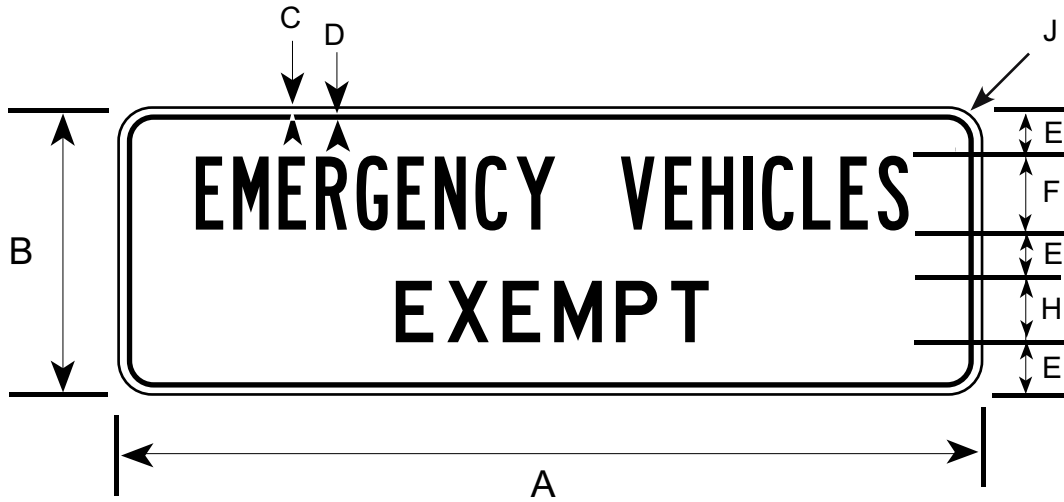

Border and Legend: Black
Background: White

Plaque associated with R3-4,
- With Expressway/Freeway crossovers

Road Class	Dimensions (inches)							
	A	B	C	D	E	F	H	J
Expy/Frwy	36	12	0.38	0.63	2.0	3B	3C	2.25



TOP
 Legend: White
 Background: Black

BOTTOM
 Border and Legend: Black
 Background: White

*Make symbol proportional to the graphic shown.

Prior to 2006 publication of this manual, this sign was numbered R3-17.

Road Class	Dimensions (inches)											
	A	B	C	D	E	F	G	H	J	K	L	M
Conv & Min	24	30	0.38	0.63	2.5	3D	2	6	4	5C	10.5	1.5

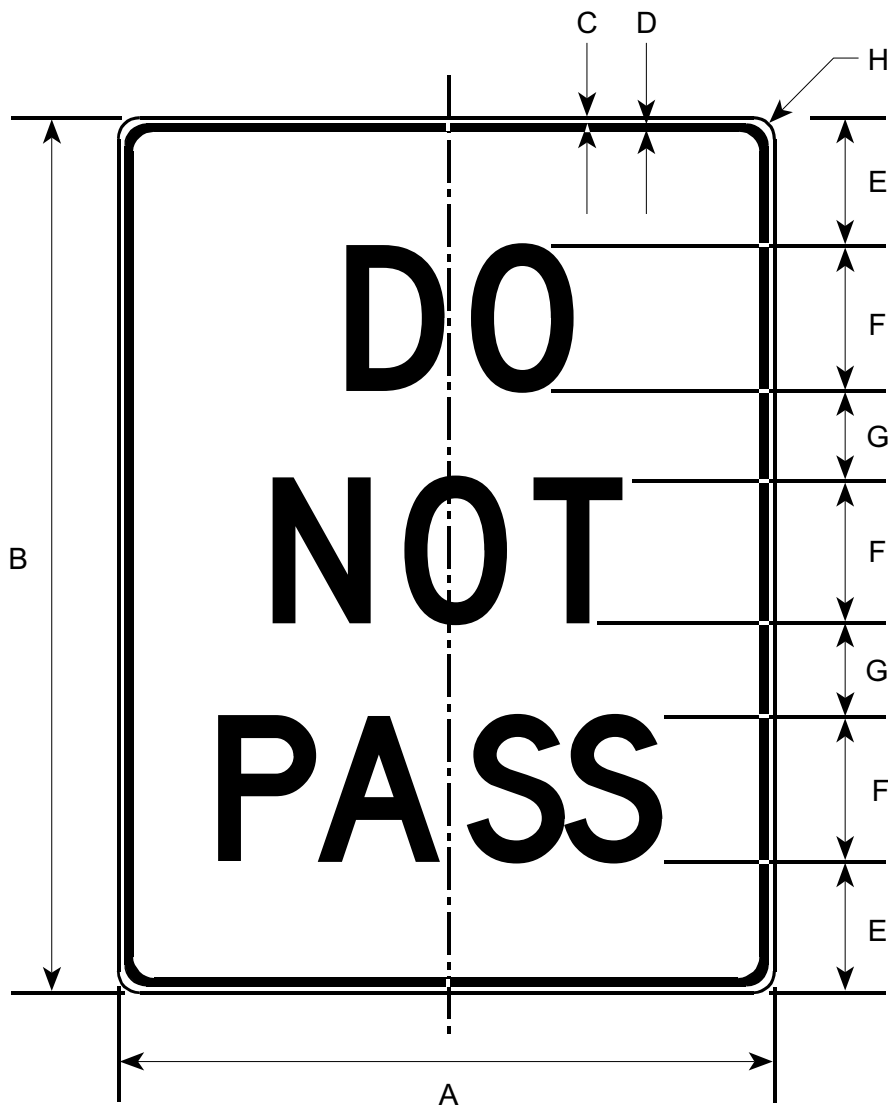

Border and Legend: Black
Background: White

Road Class	Dimensions (inches)							
	A	B	C	D	E	F	G	H
Minimum	24	30	0.38	0.63	3.5	6D	2.5	1.50
Conventional	30	36	0.50	0.75	4.5	7C	3.0	1.88
Expressway	36	48	0.63	0.88	7.0	8D	5.0	2.25
Freeway	48	60	0.75	1.25	8.0	10D	7.0	3.00

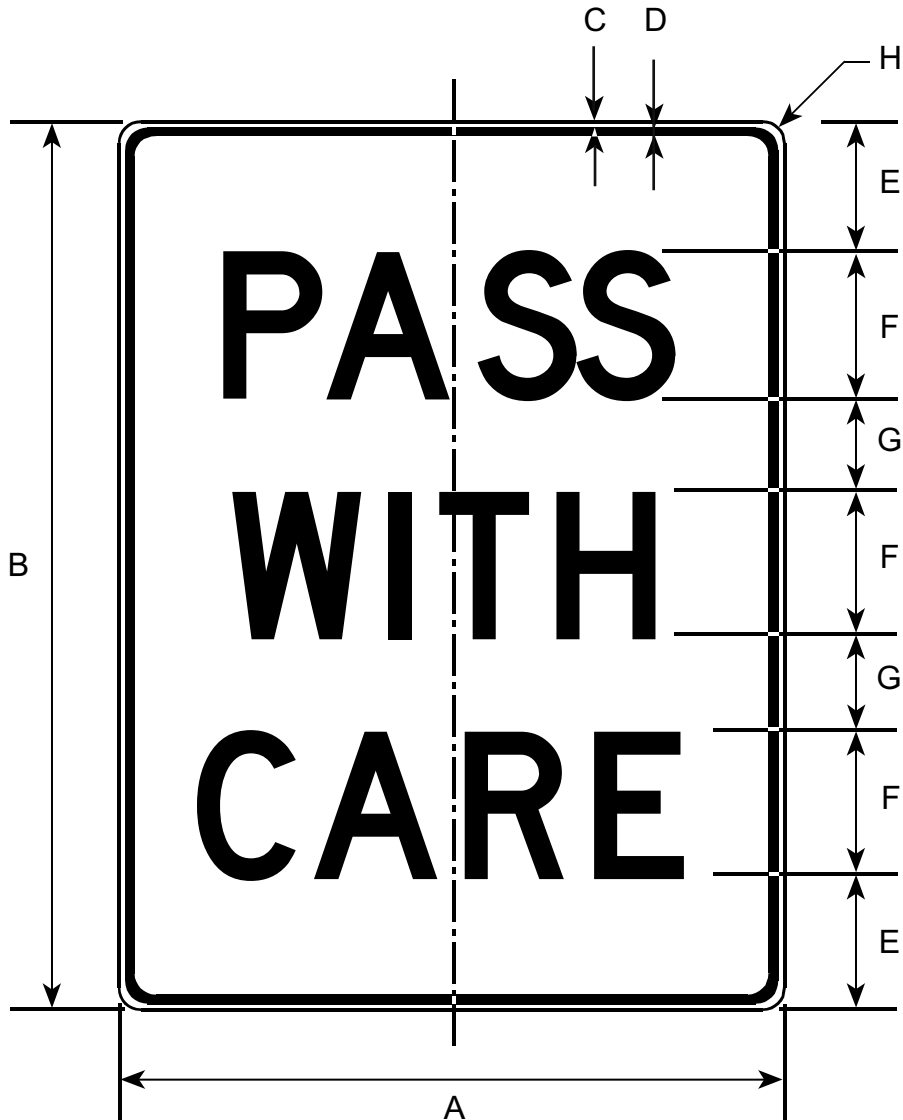

Border and Legend: Black
 Background: White

Road Class	Dimensions (inches)							
	A	B	C	D	E	F	G	H
Minimum	24	30	0.38	0.63	3.5	6C	2.5	1.50
Conventional	30	36	0.50	0.75	4.5	7C	3.0	1.88
Expressway	36	48	0.63	0.88	7.0	8C	5.0	2.25
Freeway	48	60	0.75	1.25	8.0	10C	7.0	3.00



Border and Legend: Black
 Background: White

Road Class	Dimensions (inches)							
	A	B	C	D	E	F	G	H
Minimum	24	30	0.38	0.63	3.63	4D	2.25	1.50
Conventional	36	48	0.63	0.88	6.00	6D	4.00	2.25
Expwy & Fwy	48	60	0.75	1.25	7.25	8D	4.50	3.00

R4-4

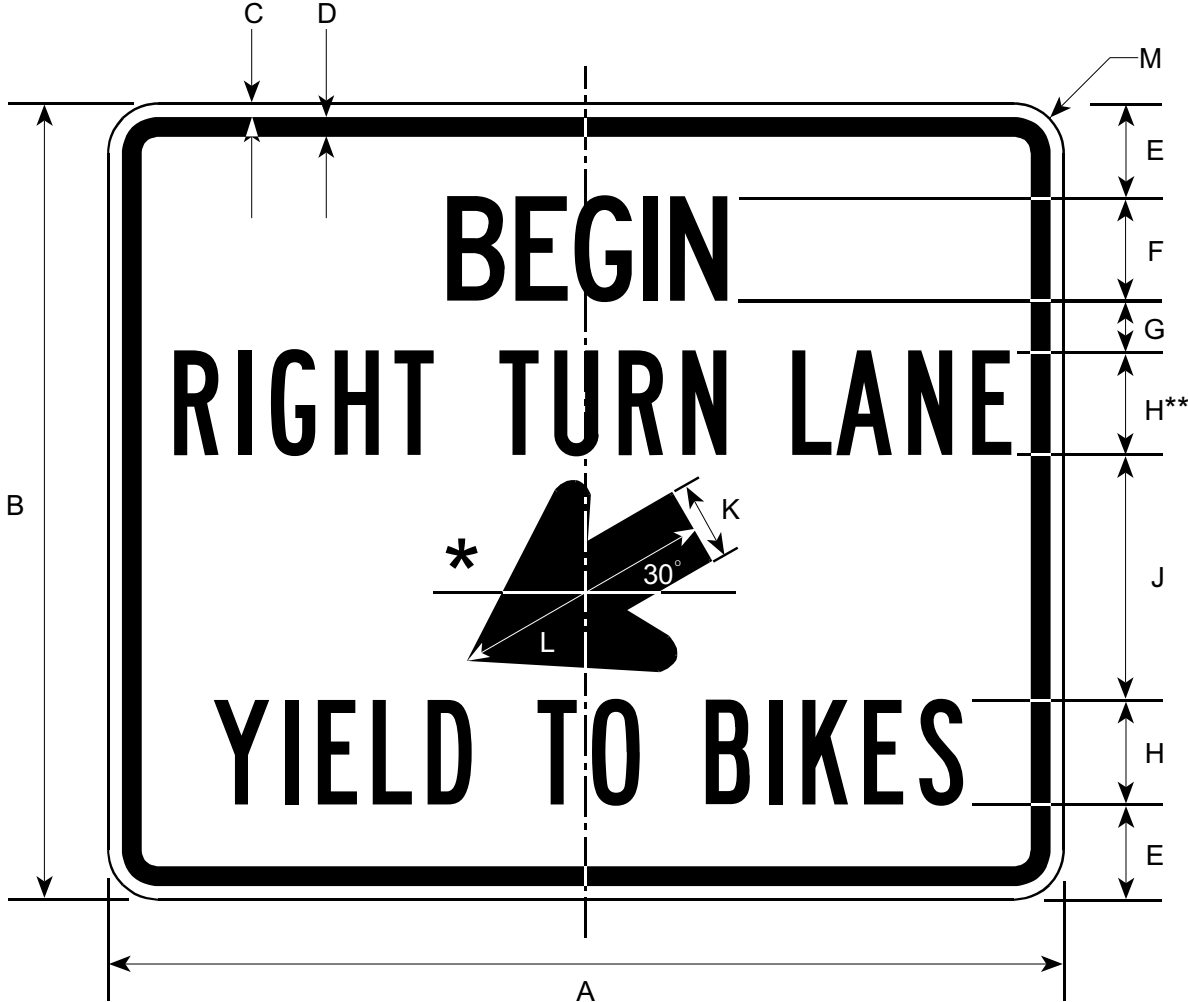

Border and Legend: Black
 Background: White

*See Appendix B-1 for Standard Arrow Details.
 ** Reduce letter spacing 20%.

Road Class	Dimensions (inches)												
	A	B	C	D	E	F	G	H	J	K	L	M	
Conv & Min	36	30	0.50	0.75	3.50	4C	2	4B	9	3.25	10	1.88	

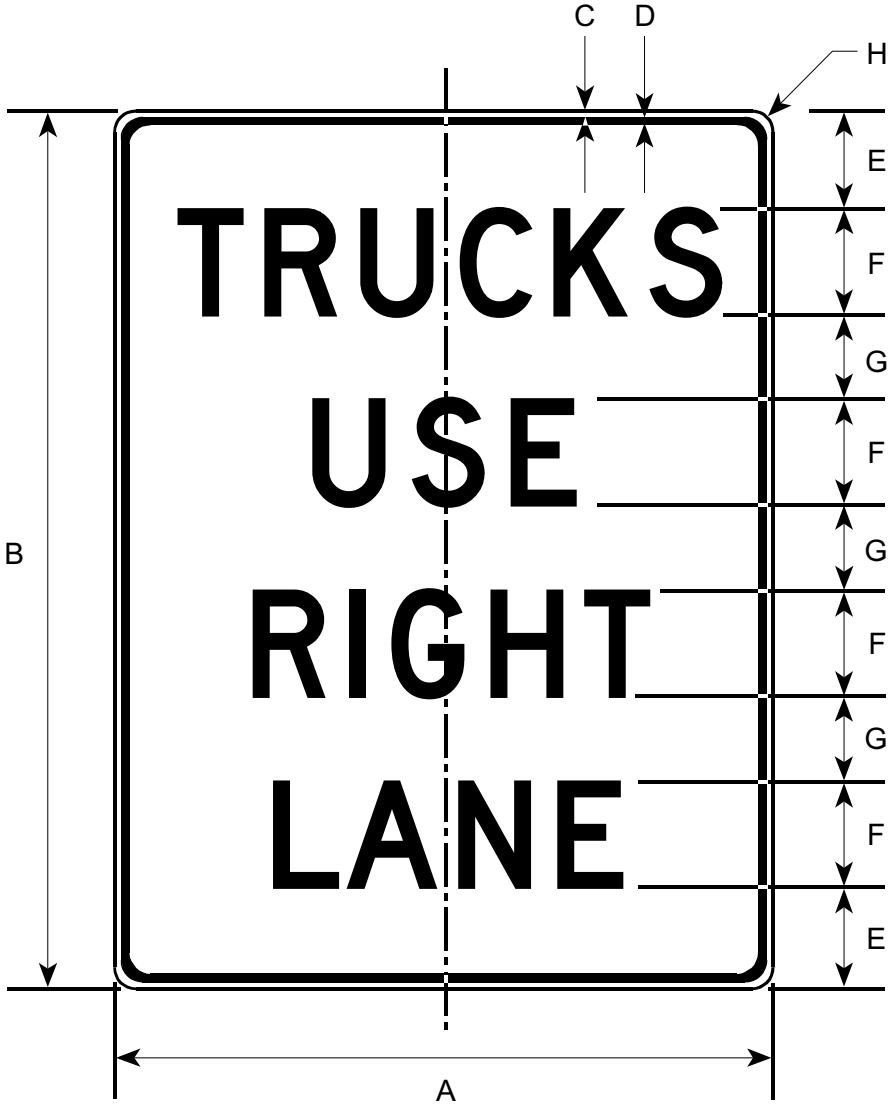

Border and Legend: Black
Background: White

Road Class	Dimensions (inches)							
	A	B	C	D	E	F	G	H
Conv & Min	36	48	0.63	0.88	6.00	6D	4.0	2.25
Expwy & Fwy	48	60	0.75	1.25	7.25	8D	4.5	3.00

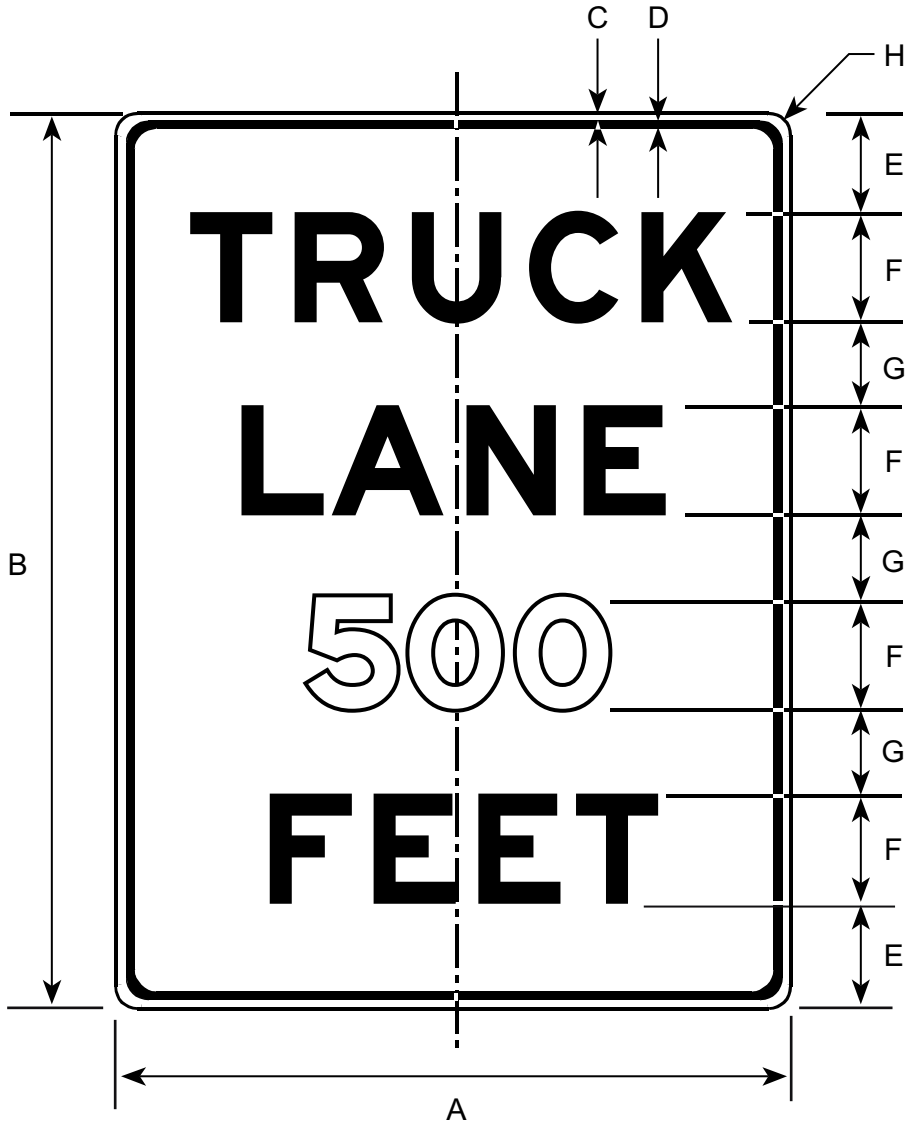

Border and Legend: Black
Background: White

Road Class	Dimensions (inches)							
	A	B	C	D	E	F	G	H
Minimum	24	30	0.38	0.63	4	4E	2.25	1.5
Conventional	36	48	0.63	0.88	6.00	6E	4.00	2.25
Expwy & Fwy	48	60	0.75	1.25	7.25	8E	4.50	3.00

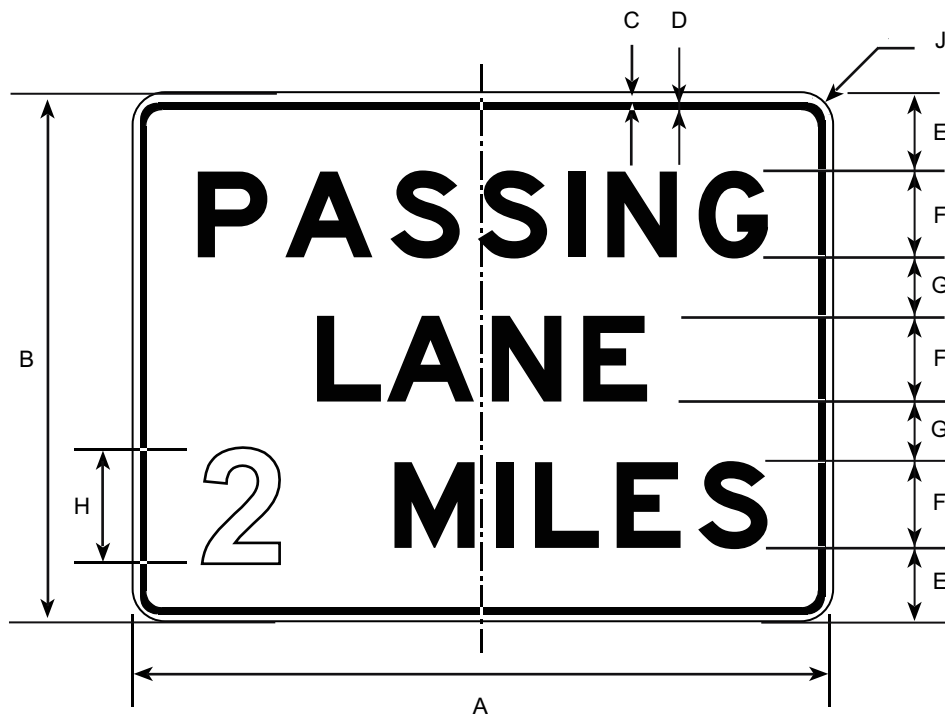

Border and Legend: Black
Background: White

Road Class	Dimensions (inches)									
	A	B	C	D	E	F	G	H	J	
Conv & Min	48	36	0.63	0.88	5	6E	4	8E	2.25	

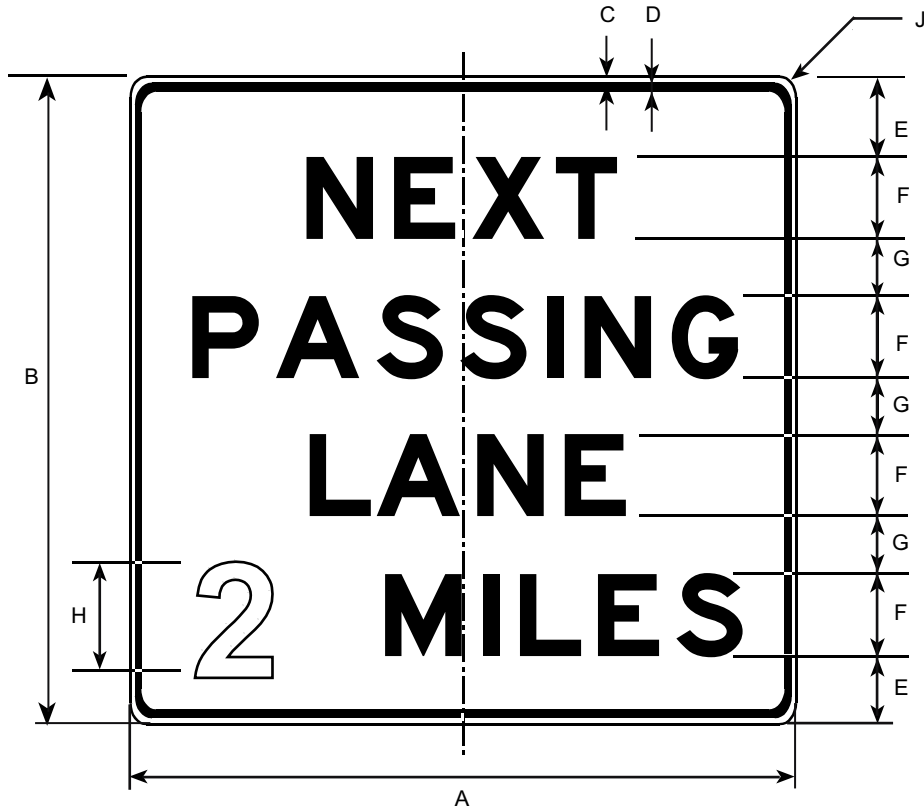

Border and Legend: Black
Background: White

Road Class	Dimensions (inches)								
	A	B	C	D	E	F	G	H	J
Conv & Min	48	48	0.63	0.88	6	6E	4	8E	2.25

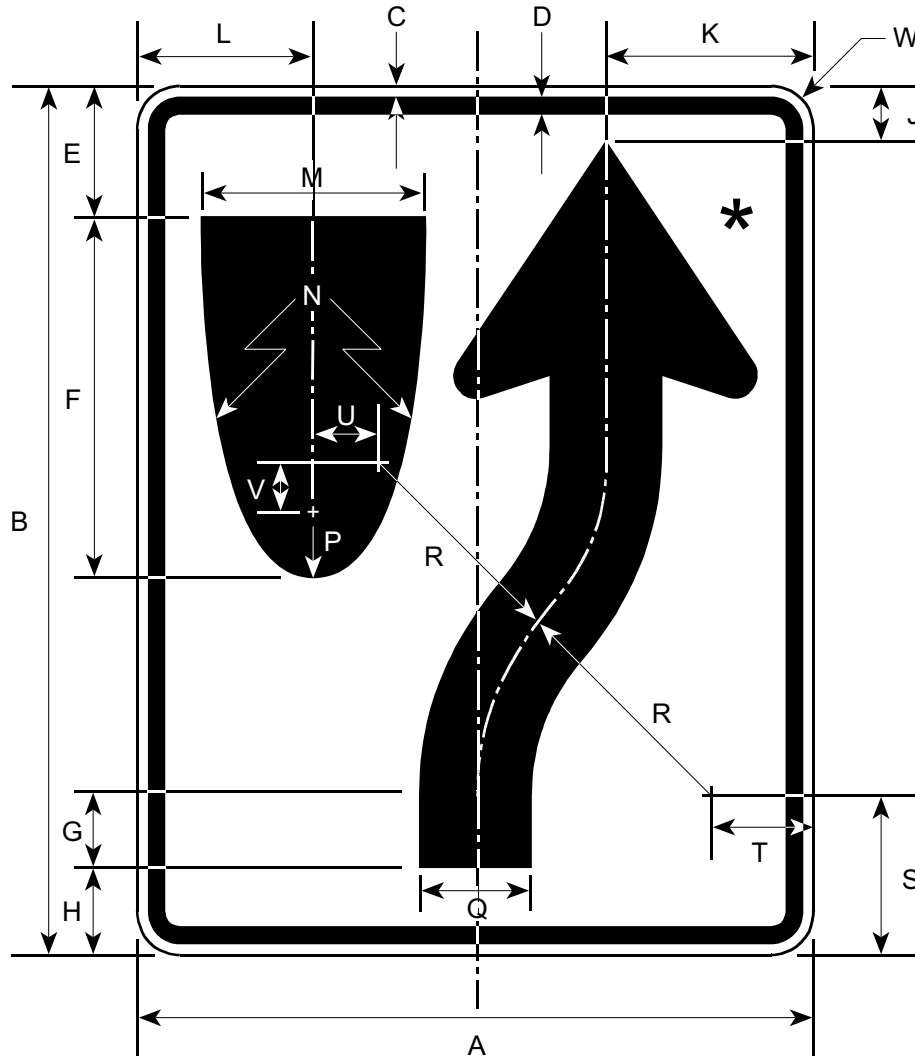

Border and Legend: Black
Background: White

*See Appendix B-1 for Standard Arrow Details.

Road Class	Dimensions (inches)																				
	A	B	C	D	E	F	G	H	J	K	L	M	N	P	Q	R	S	T	U	V	W
Minimum	18	24	0.38	0.63	3.38	9.38	1.88	2.25	1.38	5.5	4.69	6	22.5	1.5	3.0	6.75	4.13	2.25	1.06	0.44	1.5
Conv.	30	36	0.50	0.75	5.5	15.25	3.0	3.5	2.38	9.25	7.25	10	36	2.5	5.0	9.82	6.5	5.19	3.19	2.63	1.88
Expwy.	36	48	0.63	0.88	6.75	18.75	3.75	4.5	2.81	11.13	9.38	12	45	3.0	6.0	13.5	8.25	4.50	2.0	2.75	2.25
Oversized	48	60	0.75	1.25	9.0	25	5.0	6.0	3.75	14.81	12.5	16	60	4.0	8.0	18	11	6.0	2.69	5.0	3.0

R4-7A

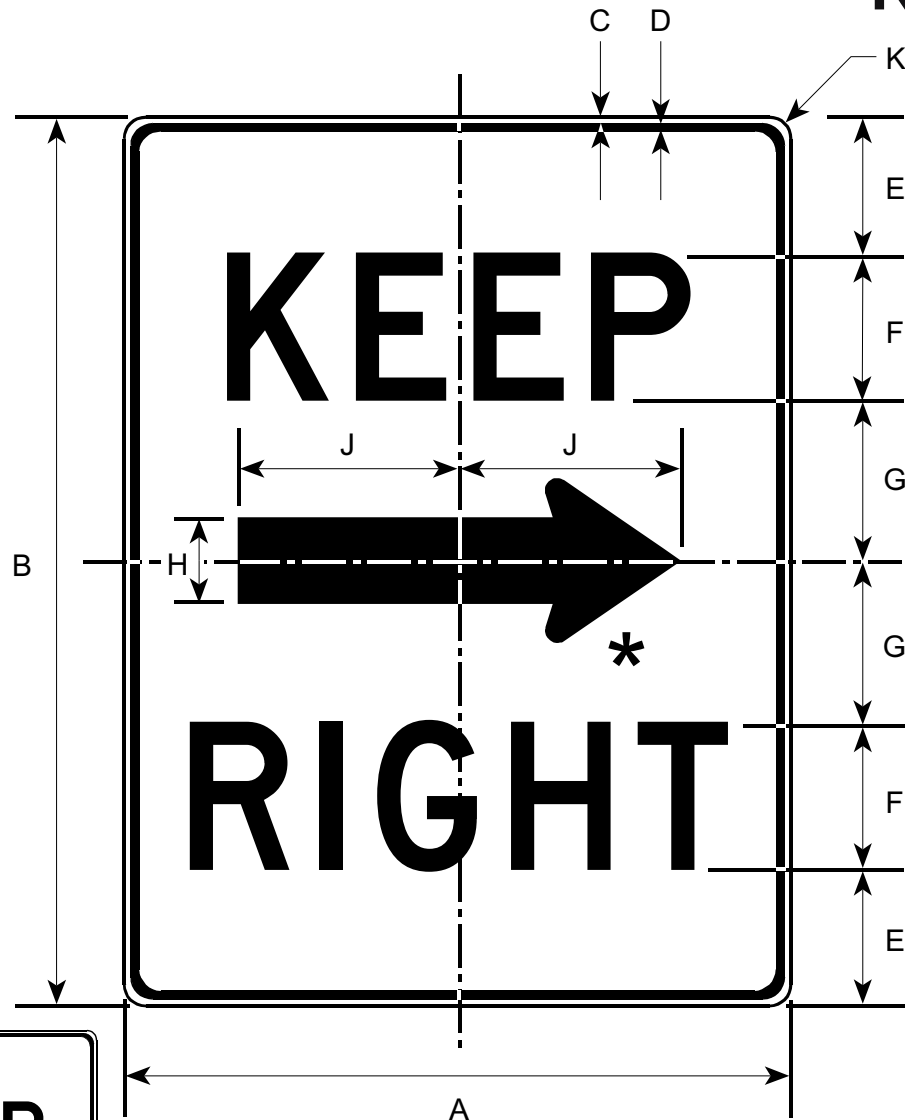

R4-7AR



R4-7AL

Border and Legend: Black
Background: White

*See Appendix B-1 for Standard Arrow Details.

Road Class	Dimensions (inches)									
	A	B	C	D	E	F	G	H	J	K
Minimum	18	24	0.38	0.63	3.75	4D	4.25	2.25	6.00	1.50
Conventional	24	30	0.38	0.63	4.50	5D	5.50	2.63	7.13	1.50
Expressway	36	48	0.63	0.88	7.50	8D	8.50	4.50	11.50	2.25
Oversized	48	60	0.75	1.25	9.00	10D	11.00	5.25	14.25	3.00

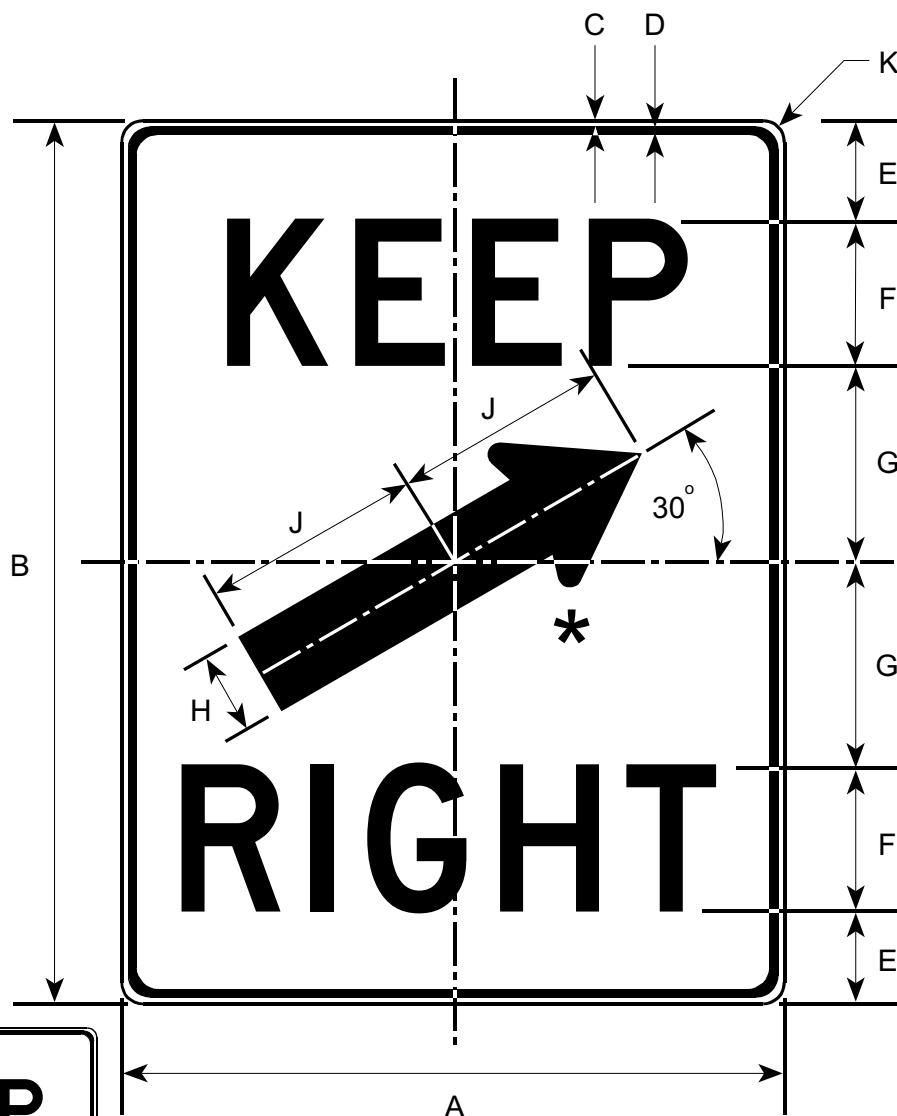

R4-7BR



R4-7BL

Border and Legend: Black
Background: White

*See Appendix B-1 for Standard Arrow Details.

Road Class	Dimensions (inches)									
	A	B	C	D	E	F	G	H	J	K
Minimum	18	24	0.38	0.63	2.5	4D	5.5	2.25	6.0	1.5
Conventional	24	30	0.38	0.63	3.0	5D	7.0	2.63	7.13	1.5
Expressway	36	48	0.63	0.88	5.0	8D	11	4.5	11.44	2.25
Oversized	48	60	0.75	1.25	6.0	10D	14	5.25	14.25	3.0

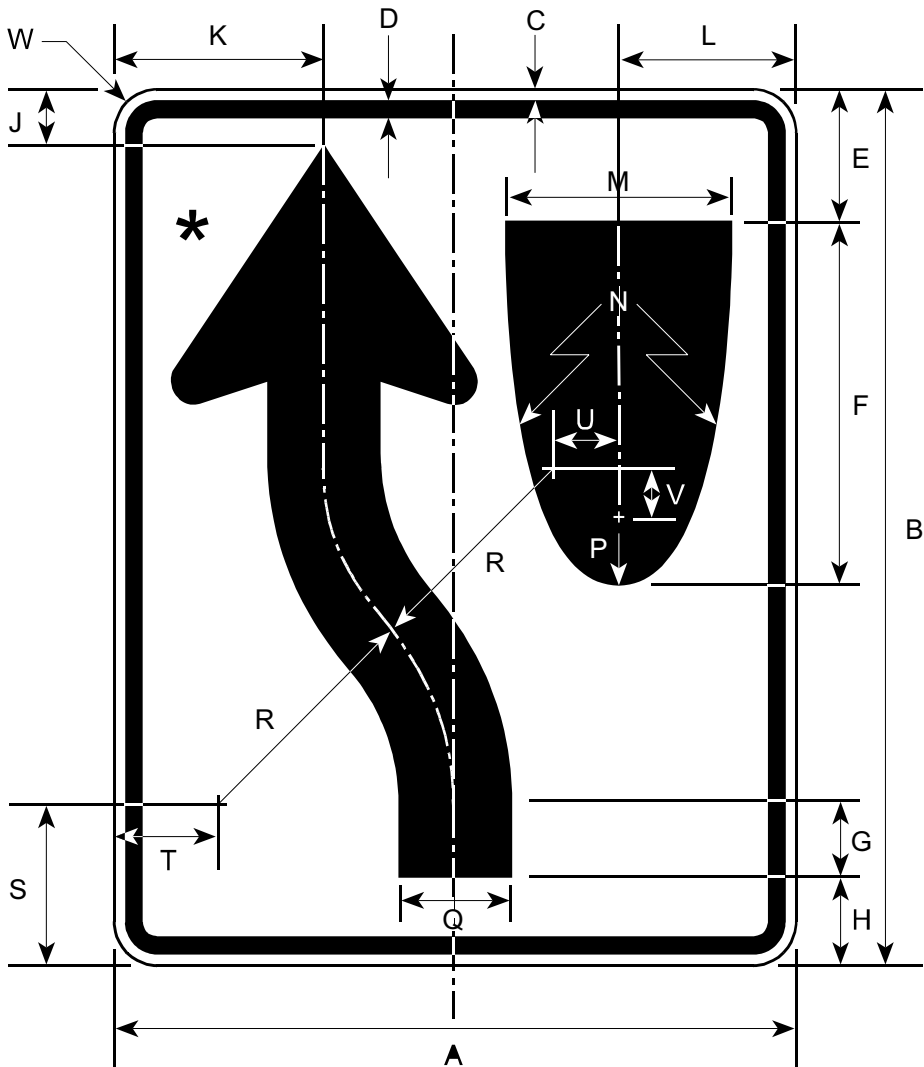

Border and Legend: Black
Background: White

*See Appendix B-1 for Standard Arrow Details.

Road Class	Dimensions (inches)																				
	A	B	C	D	E	F	G	H	J	K	L	M	N	P	Q	R	S	T	U	V	W
Minimum	18	24	0.38	0.63	3.38	9.38	1.88	2.25	1.38	5.5	4.69	6.0	22.5	1.5	3.0	6.75	4.13	2.25	1.06	0.44	1.5
Conv.	24	30	0.38	0.63	4.5	12.5	2.5	3.0	1.88	7.38	6.25	8.0	30	2.0	4.0	9.0	5.5	3.0	1.38	2.81	1.5
Expwy.	36	48	0.63	0.88	6.75	18.75	3.75	4.50	2.81	11.13	9.38	12	45	3.0	6.0	13.5	8.25	4.5	2.0	2.75	2.25
Oversized	48	60	0.75	1.25	9.0	25	5.0	6.0	3.75	14.81	12.5	16	60	4.0	8.0	18	11	6.0	2.69	5.0	3.0

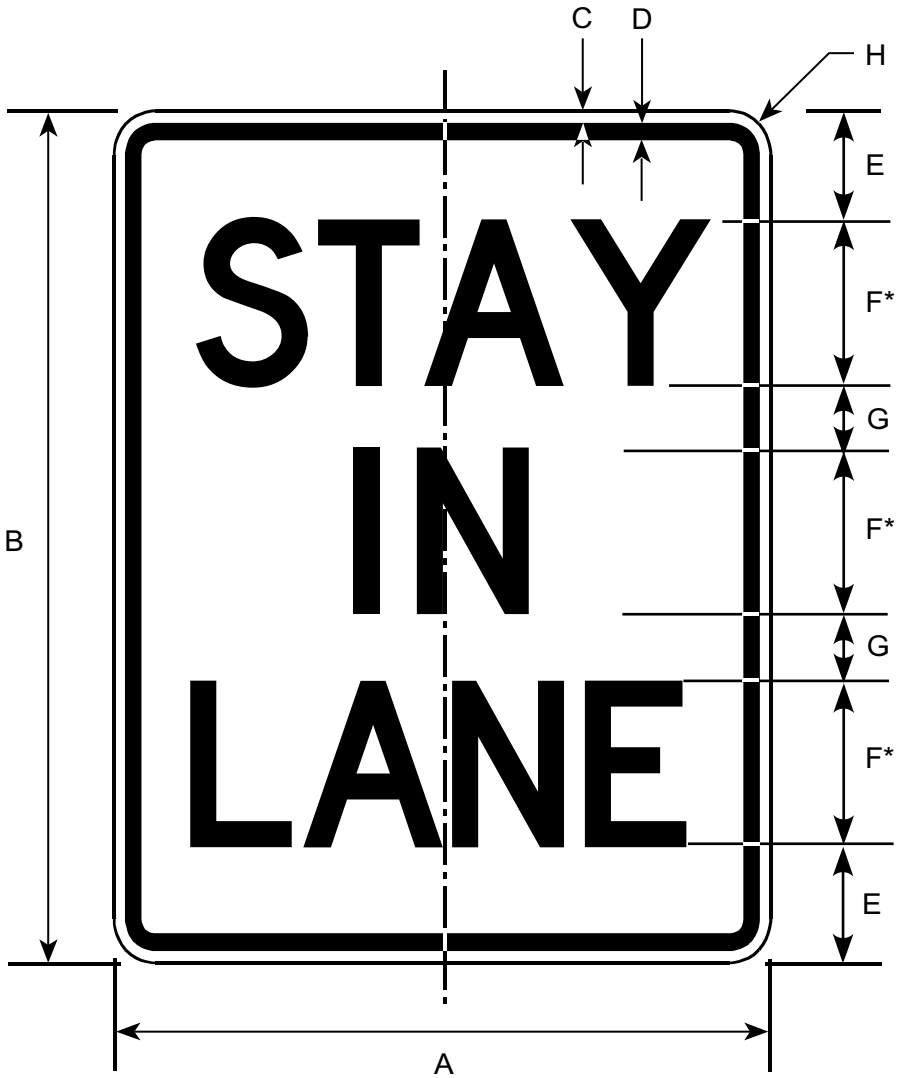

Border and Legend: Black
 Background: White

* Reduce spacing to fit.

Road Class	Dimensions (inches)							
	A	B	C	D	E	F	G	H
Minimum	18	24	0.38	0.63	3.00	4D	3.00	1.50
Conventional	24	30	0.38	0.63	3.69	5D	3.81	1.50
Expressway	36	48	0.63	0.88	8.25	7D	5.25	2.25
Freeway	48	60	0.75	1.25	7.50	10D	7.50	3.00

R4-10

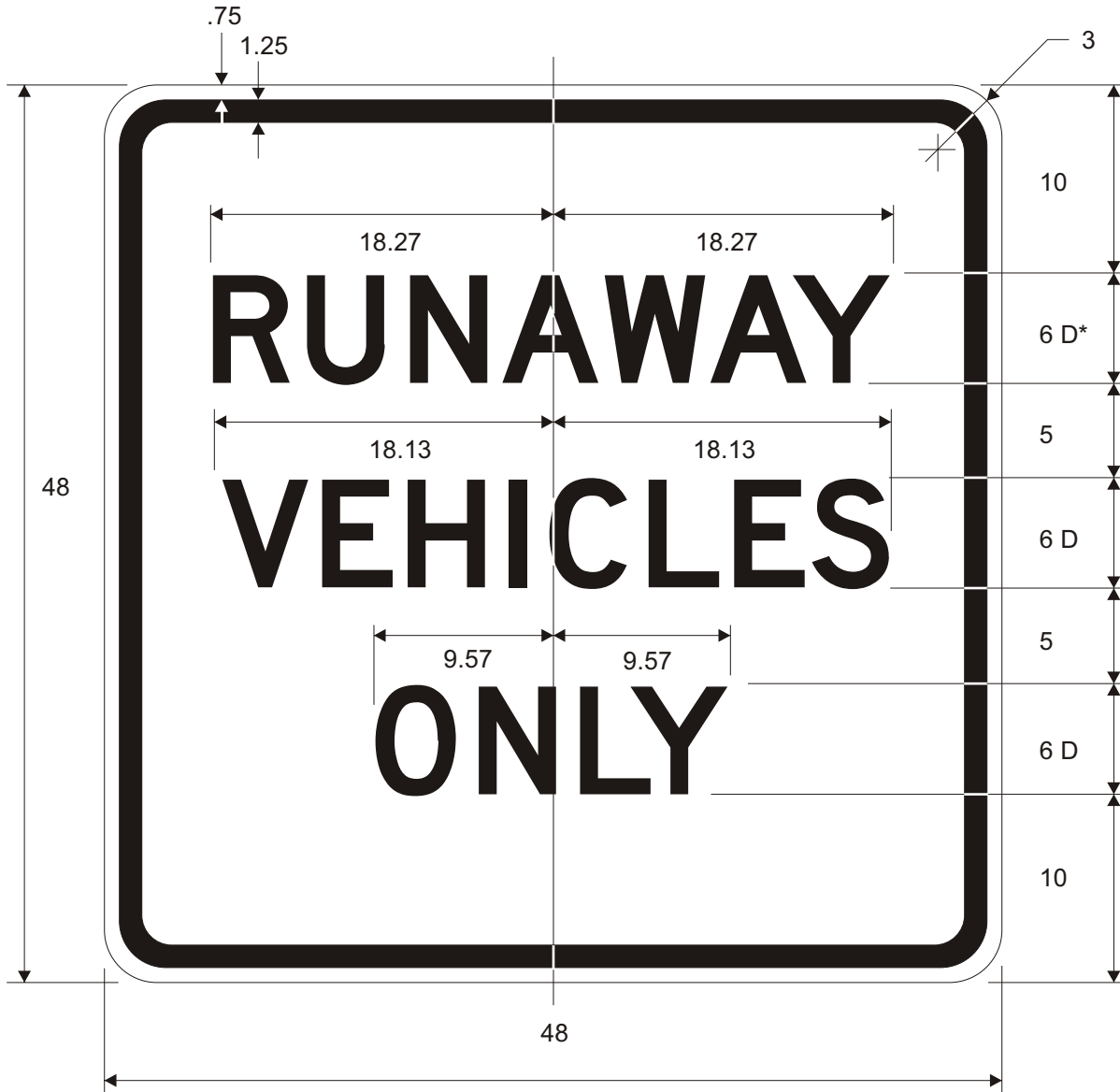

Border and Legend: Black
Background: White

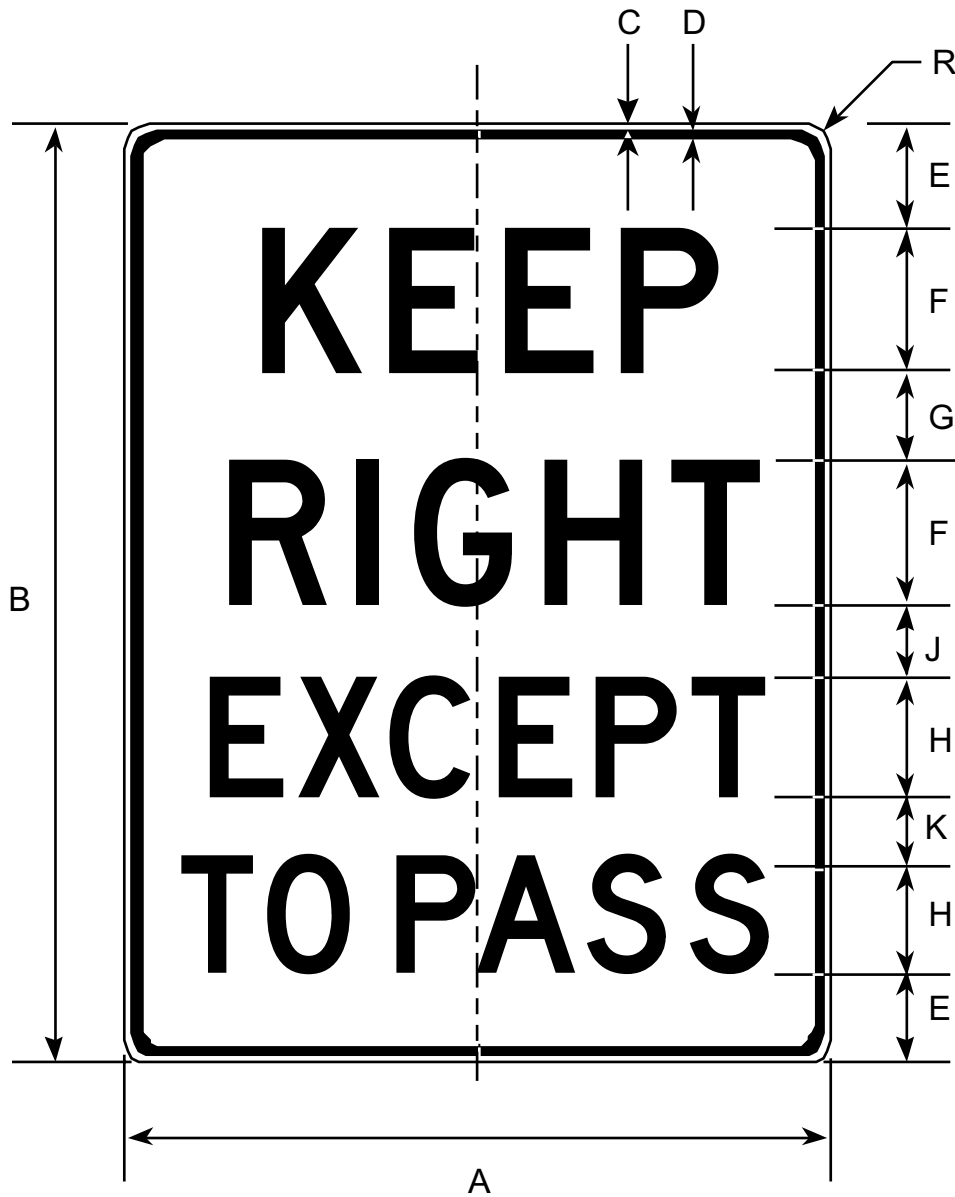

Border and Legend: Black
Background: White

Road Class	Dimensions (inches)										
	A	B	C	D	E	F	G	H	J	K	R
Conventional	36	48	0.63	0.88	4.0	8D	5	6C	4	3	2.25
Oversized	48	60	0.75	1.25	4.5	10D	6	8C	5	4	3.00

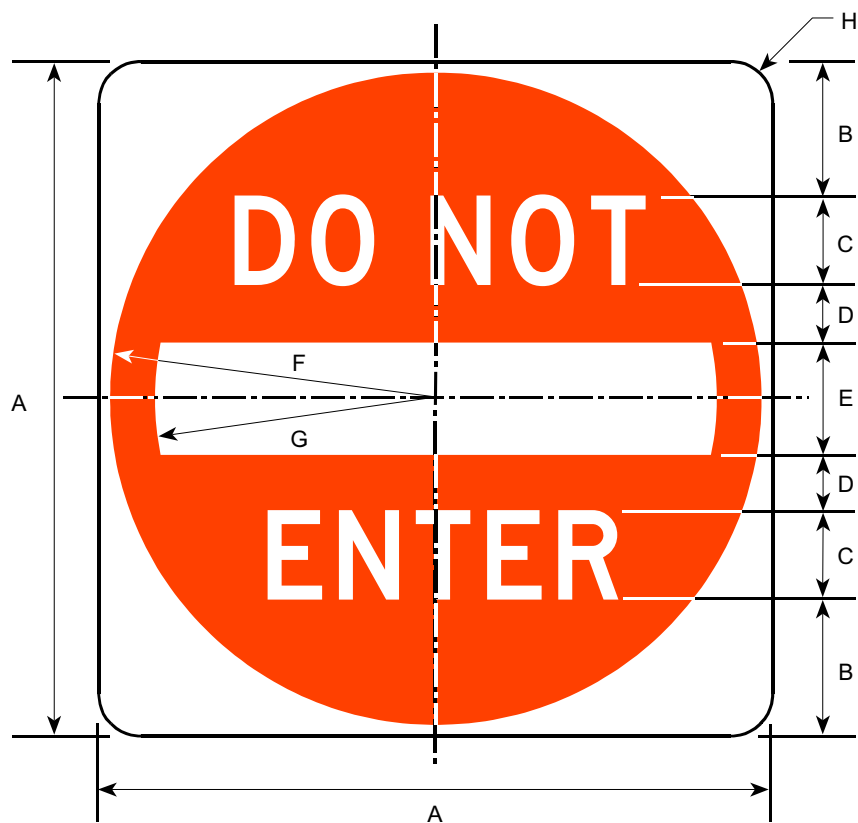

Border and Legend: White
Background: Red

Road Class	Dimensions (inches)							
	A	B	C	D	E	F	G	H
Minimum	30	6.5	4D	2.0	5	14.5	12.5	1.88
Conventional	36	7.5	5D	2.5	6	17.5	15.0	2.25
Expwy & Fwy	48	11.0	6D	3.0	8	23.5	20.0	3.00

R5-1A

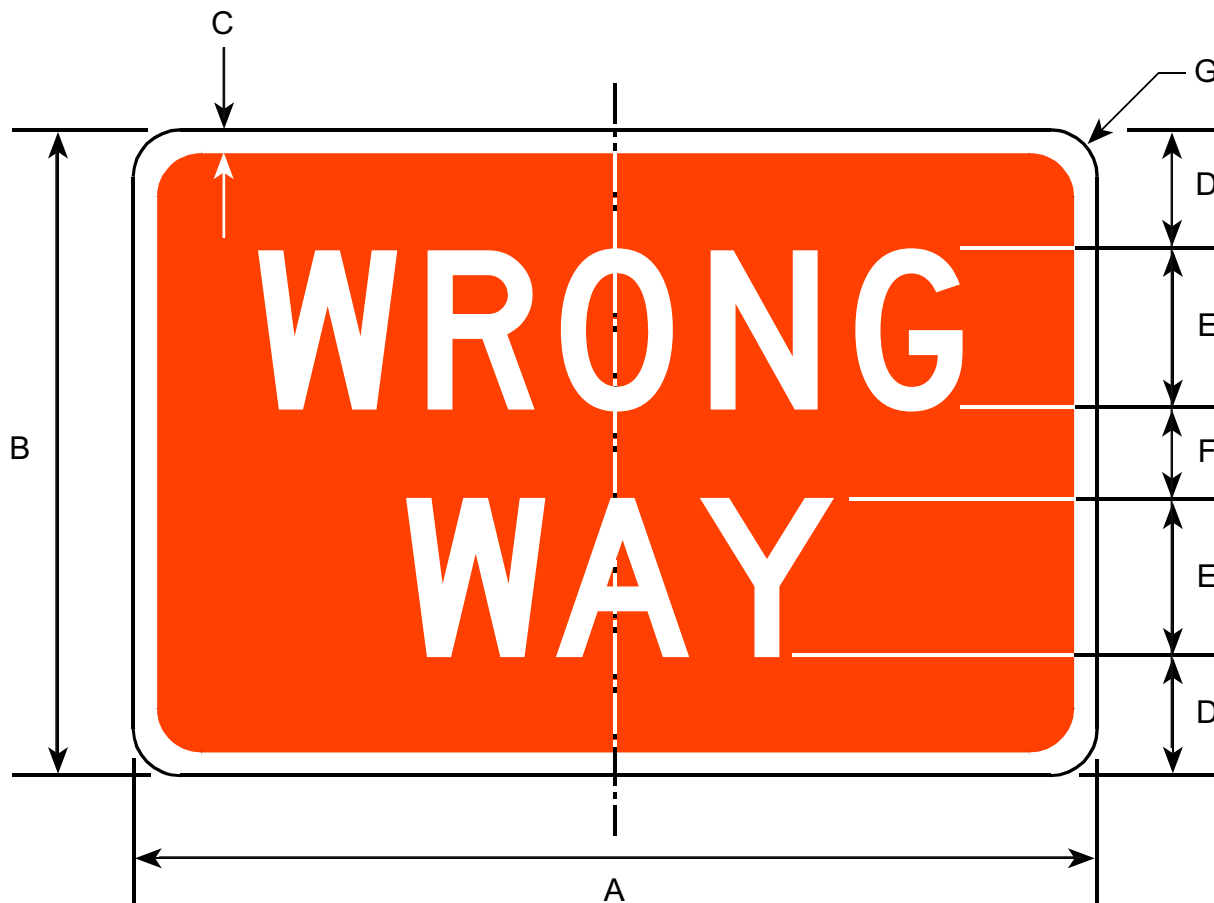

Border and Legend: White
Background: Red

Road Class	Dimensions (inches)						
	A	B	C	D	E	F	G
Minimum	30	18	0.63	3.0	5D	2	1.50
Conventional	36	24	0.75	4.5	6D	3	1.50
Expwy & Fwy	42	30	0.88	5.0	8D	4	1.88

R5-1B

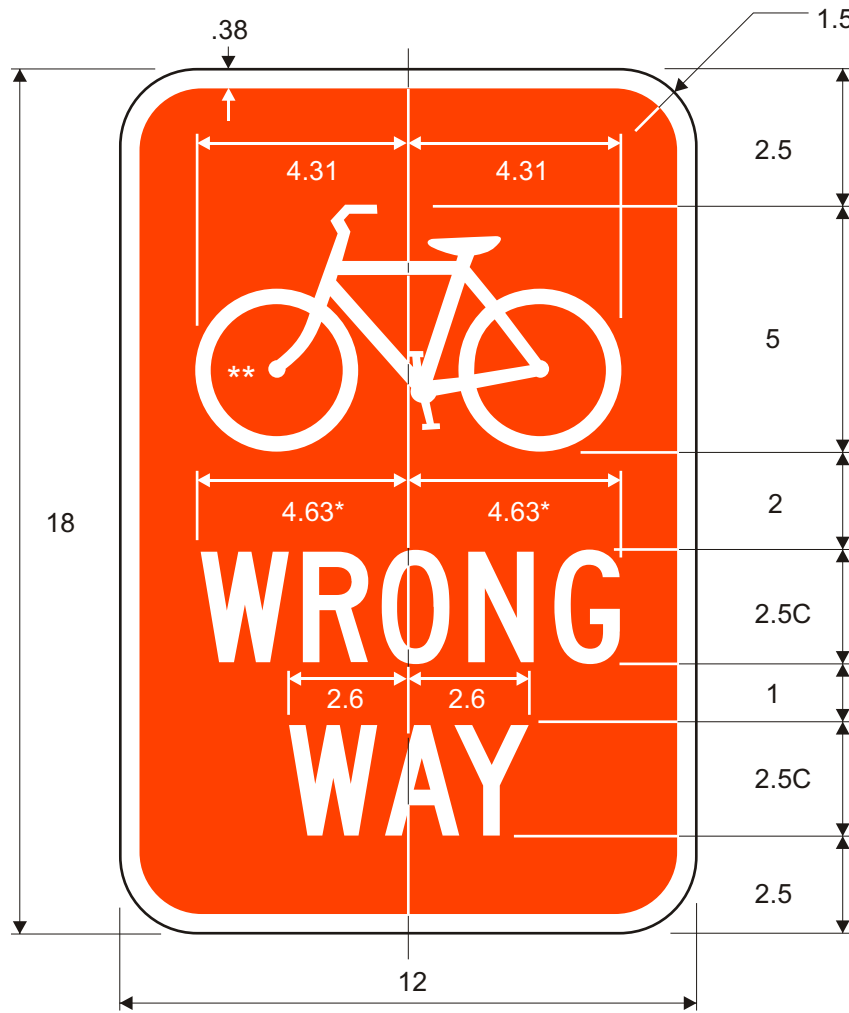

*Reduce spacing to fit.

Border and Legend: White
Background: Red

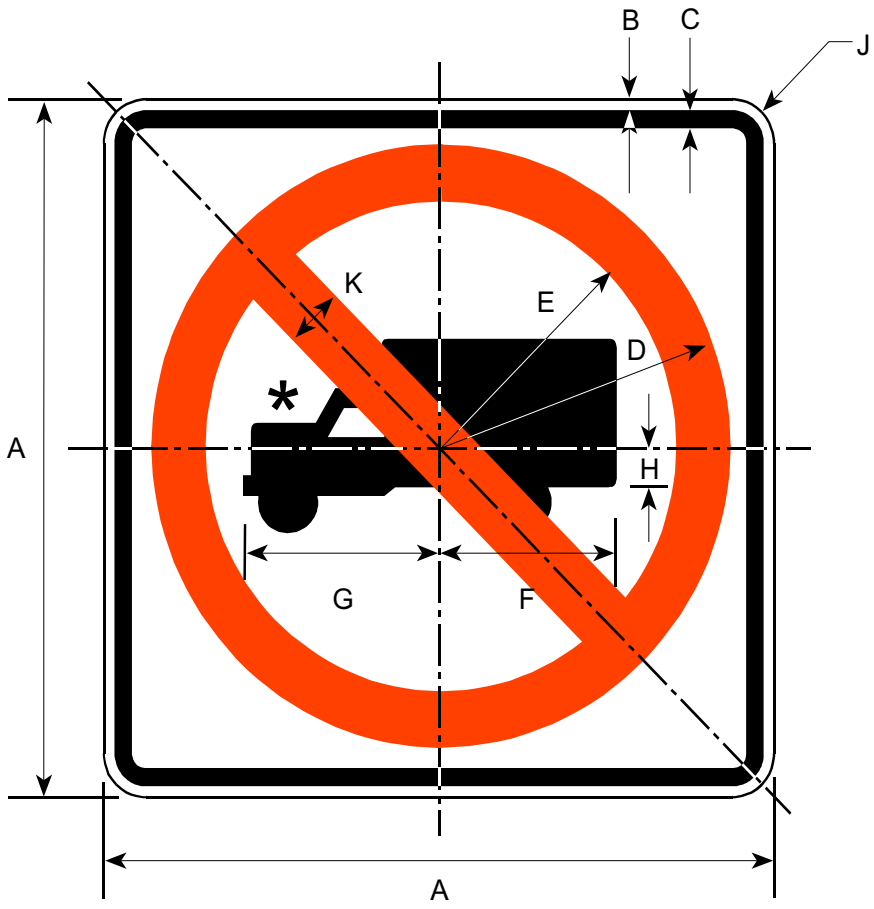

Circle & Diagonal: Red
 Border and Symbol: Black
 Background: White

*Make symbol proportional to the graphic shown.

Road Class	Dimensions (inches)									
	A	B	C	D	E	F	G	H	J	K
Minimum	24	0.38	0.63	10.5	8.5	6.5	6.88	1.38	1.5	1.0
Conventional	30	0.50	0.75	13.13	10.63	8.13	8.5	1.63	1.88	2.5
Expressway	36	0.63	0.88	15.75	12.75	9.75	10.25	2.0	2.25	3.0
Freeway	48	0.75	1.25	21	17	13	13.63	2.63	3.0	4.0

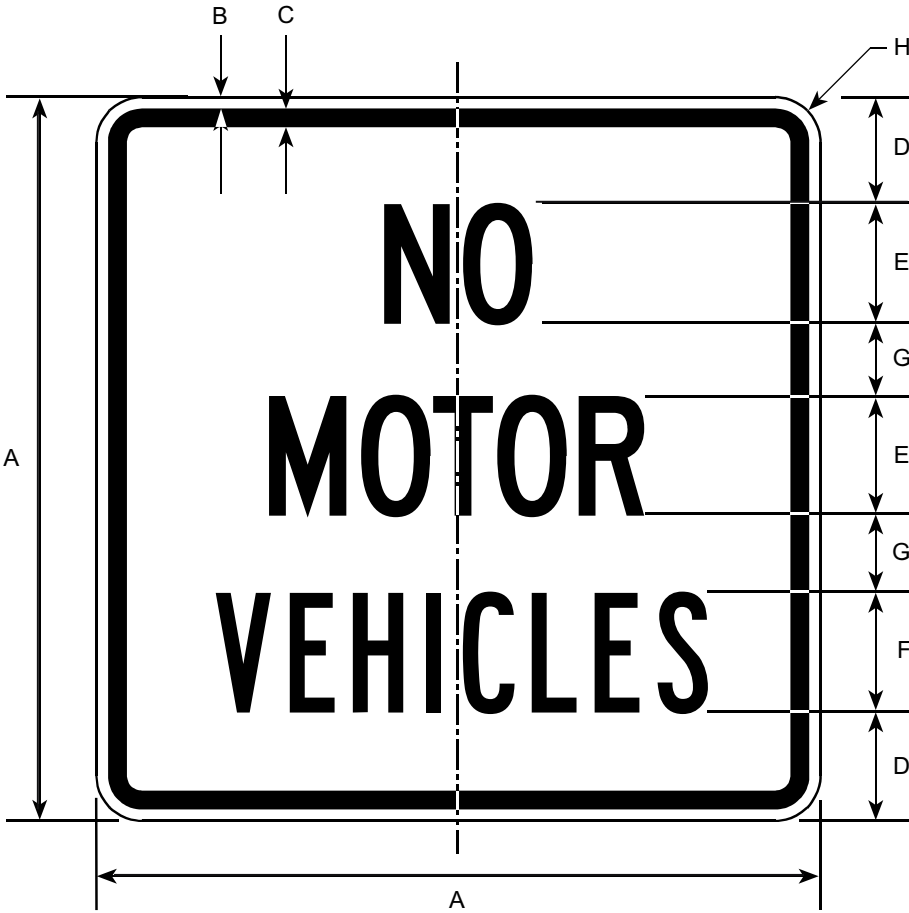

Border and Legend: Black
 Background: White

Road Class	Dimensions (inches)							
	A	B	C	D	E	F	G	H
Minimum	18	0.38	0.63	2.5	3C	3B	2	1.5
Conventional	24	0.38	0.63	3.50	4C	4B	2.50	1.5

R5-3A
R5-3AP

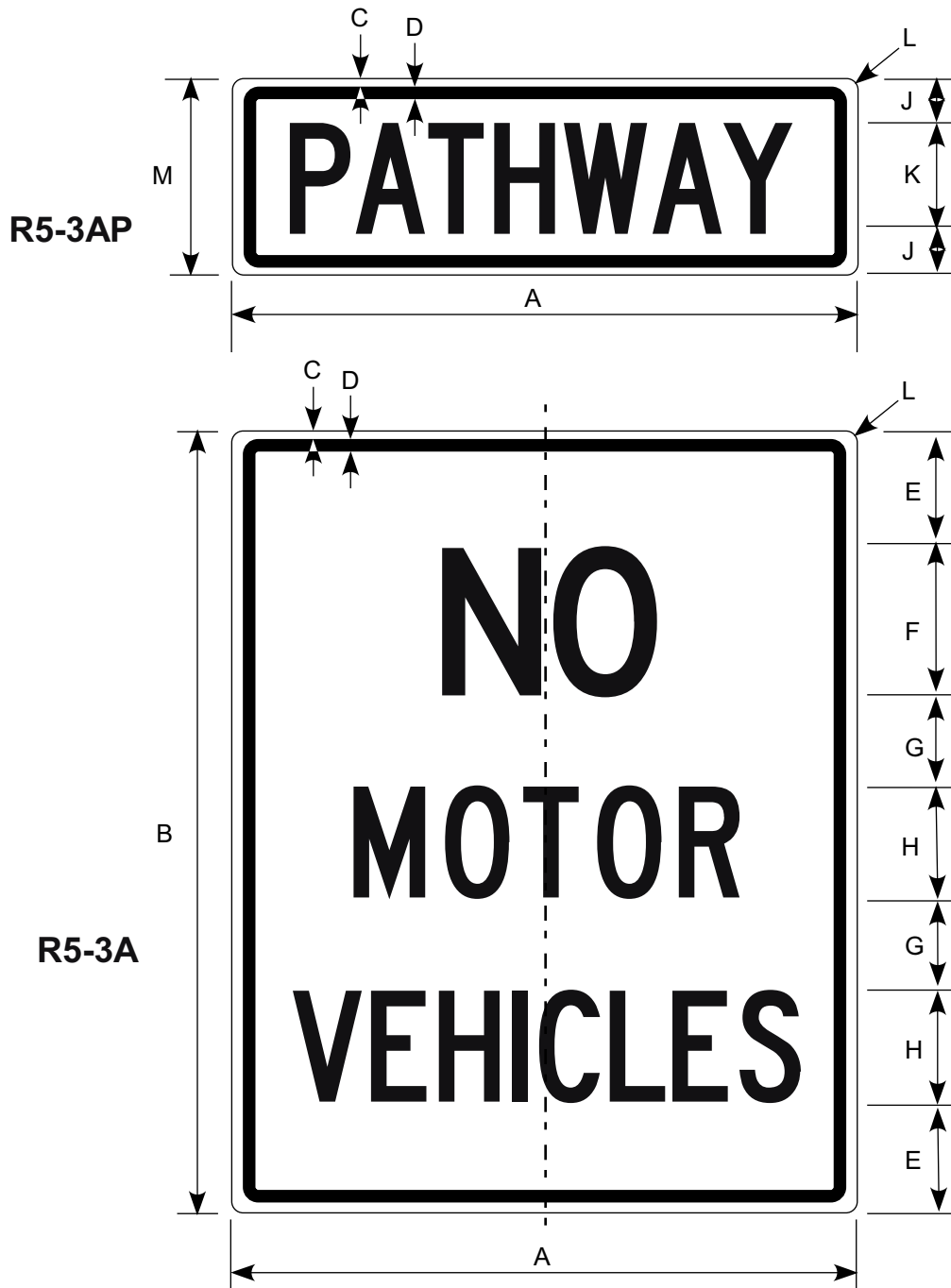

Border and Legend: Black
Background: White

Road Class	Dimensions (inches)											
	A	B	C	D	E	F	G	H	J	K	L	M
Minimum	12	18	0.38	0.63	3.0	3C	2.5	2B	2.0	2B	1.5	6.0
Conventional	18	24	0.38	0.63	4.0	4C	3.0	3B	1.5	3C	1.5	6.0

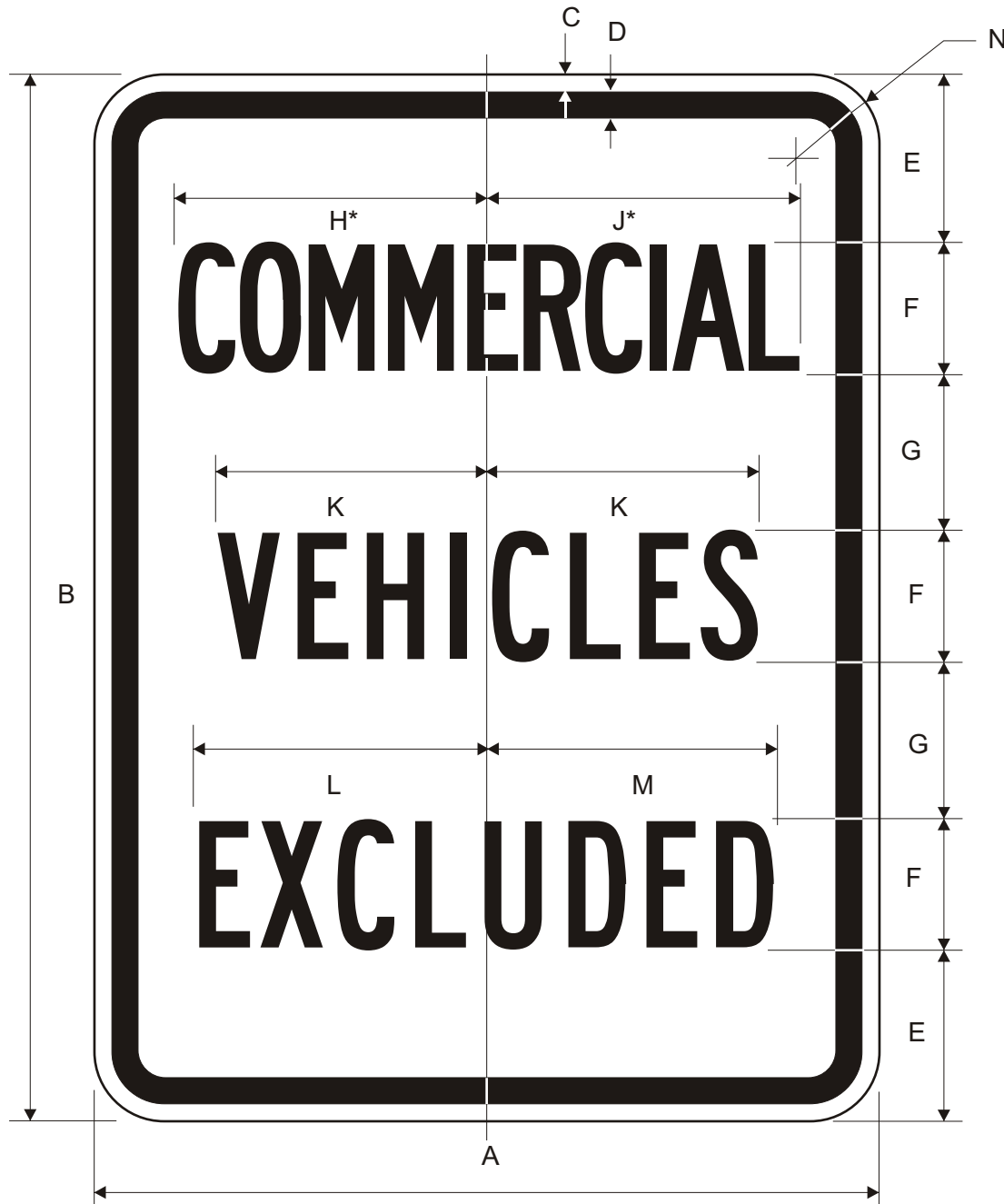

Border and Legend: Black
Background: White

*Reduce spacing 50%.

Road Class	Dimensions (inches)												
	A	B	C	D	E	F	G	H	J	K	L	M	N
Conv.	24	30	0.38	0.63	5.0	4B	4.0	9.5	9.81	8.25	8.69	6.69	1.5
Expy.	36	48	0.63	0.88	8.5	6B	6.5	14.25	14.69	12.38	13	13.38	2.25
Fwy.	48	60	0.75	1.25	10	8B	8.0	19	19.63	16.5	17.38	17.88	3.0

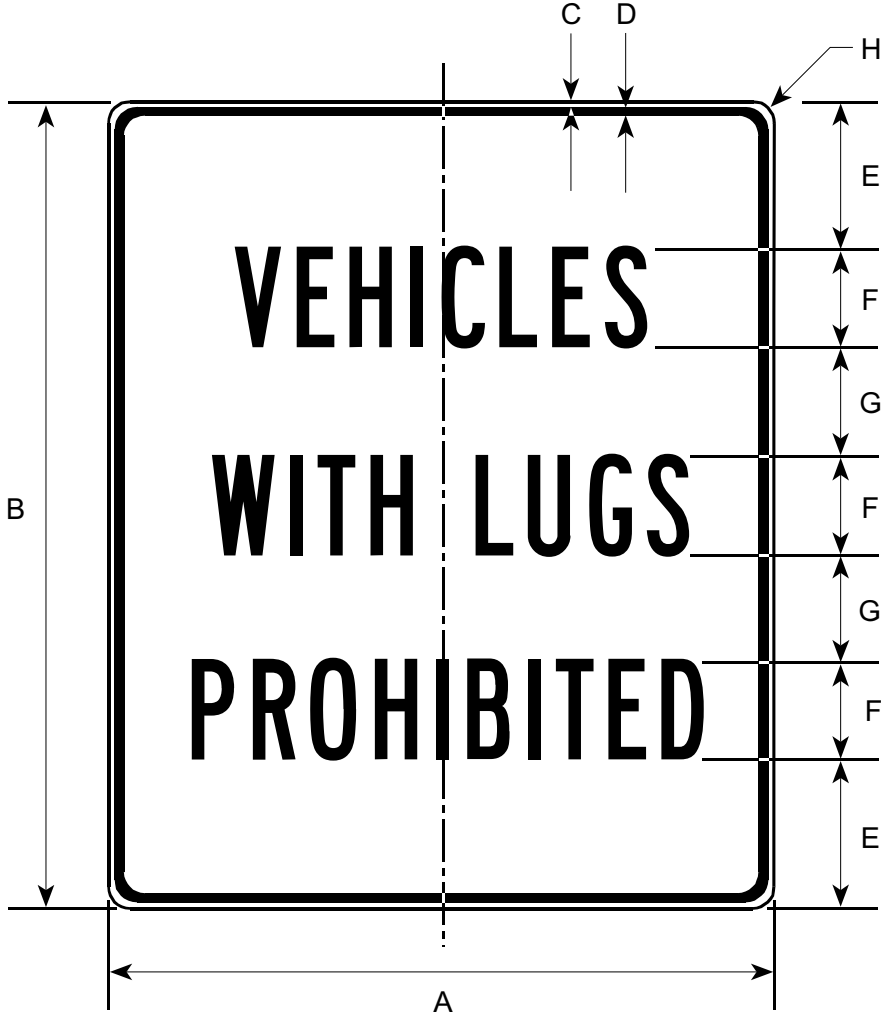

Border and Legend: Black
 Background: White

Road Class	Dimensions (inches)							
	A	B	C	D	E	F	G	H
Conv & Min	24	30	0.38	0.63	5.0	4B	4.0	1.50
Expressway	36	48	0.63	0.88	8.5	6B	6.5	2.25
Freeway	48	60	0.75	1.25	10.0	8B	8.0	3.00

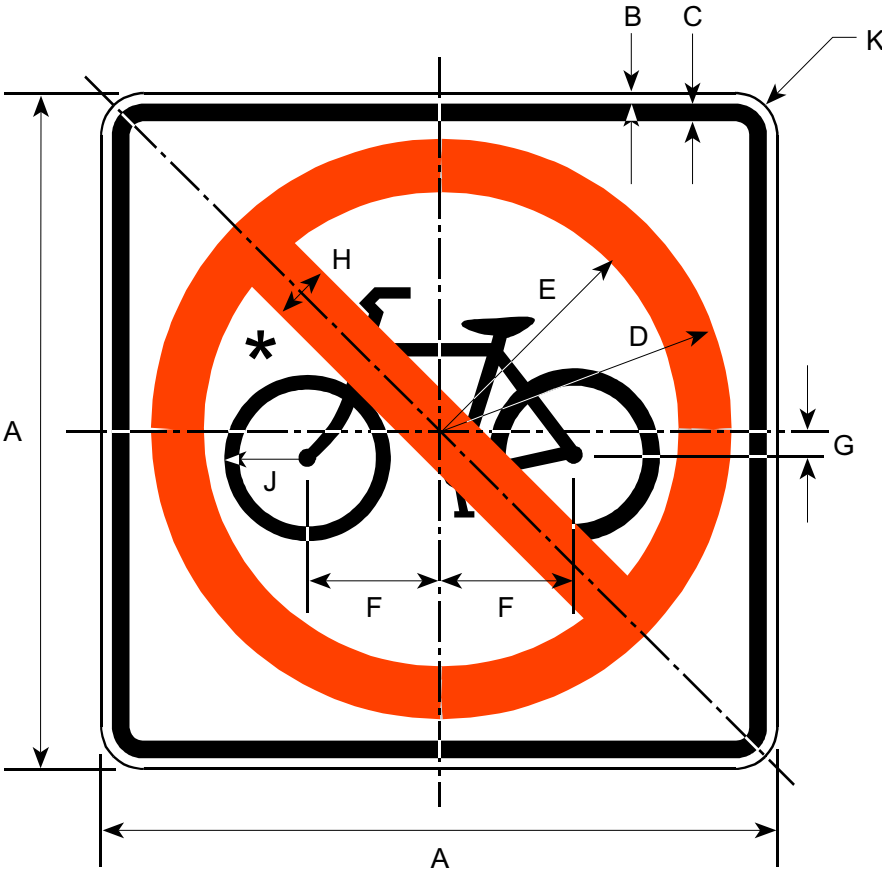

Circle & Diagonal: Red
 Border and Symbol: Black
 Background: White

* Make symbol proportional to the graphic shown

Road Class	Dimensions (inches)									
	A	B	C	D	E	F	G	H	J	K
Minimum	24	0.38	0.63	10.5	8.5	4.75	0.75	2.0	3.0	1.5
Conventional	30	0.50	0.75	13.13	10.63	5.88	0.88	2.5	3.75	1.88
Expressway	36	0.63	0.88	15.75	12.75	7.13	1.13	3.0	4.5	2.25
Freeway	48	0.75	1.25	21	17	9.5	1.5	4.0	6.0	3.0



Border and Legend: Black
Background: White

Road Class	Dimensions (inches)											
	A	B	C	D	E	F	G	H	J	K	L	M
Conv.	30	24	0.5	0.75	4.25	3.5B	2.5	3.5D	12.45	8.94	12.73	1.88
Expy.	42	24	0.63	0.88	3.5	4B	2.5	4D	14.22	10.22	14.55	2.25
Fwy.	48	30	0.75	1.25	4	5B	3.5	5D	17.77	12.77	18.18	3

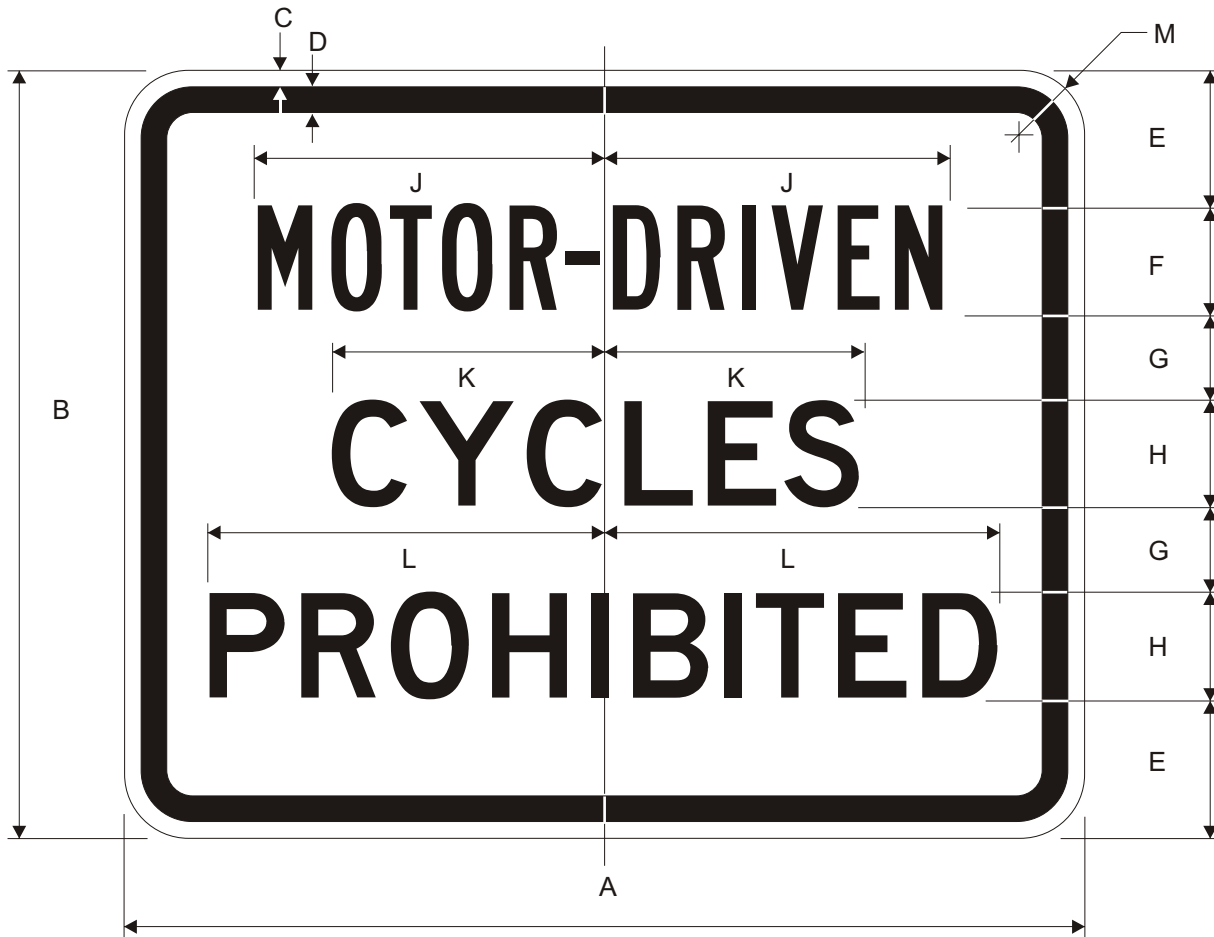

Border and Legend: Black
Background: White

Road Class	Dimensions (inches)											
	A	B	C	D	E	F	G	H	J	K	L	M
Conv.	30	24	0.5	0.75	4.25	3.5B	2.5	3.5D	11.19	8.56	12.73	1.88
Expy.	42	24	0.625	0.88	3.5	4B	2.5	4D	9.78	14.55	14.55	2.25
Fwy.	48	30	0.75	1.25	4	5B	3.5	5D	15.99	12.23	18.18	3

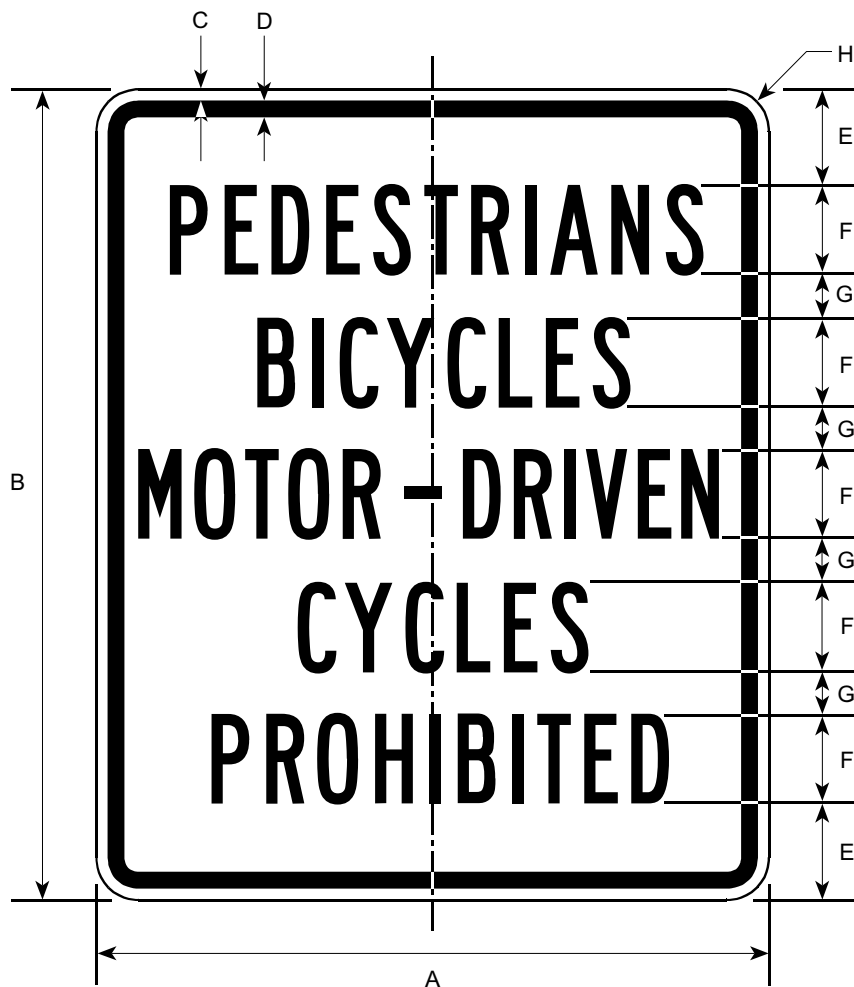

Border and Legend: Black
Background: White

Road Class	Dimensions (inches)							
	A	B	C	D	E	F	G	H
Conv & Min	30	36	0.50	0.75	4	4B	2	1.88

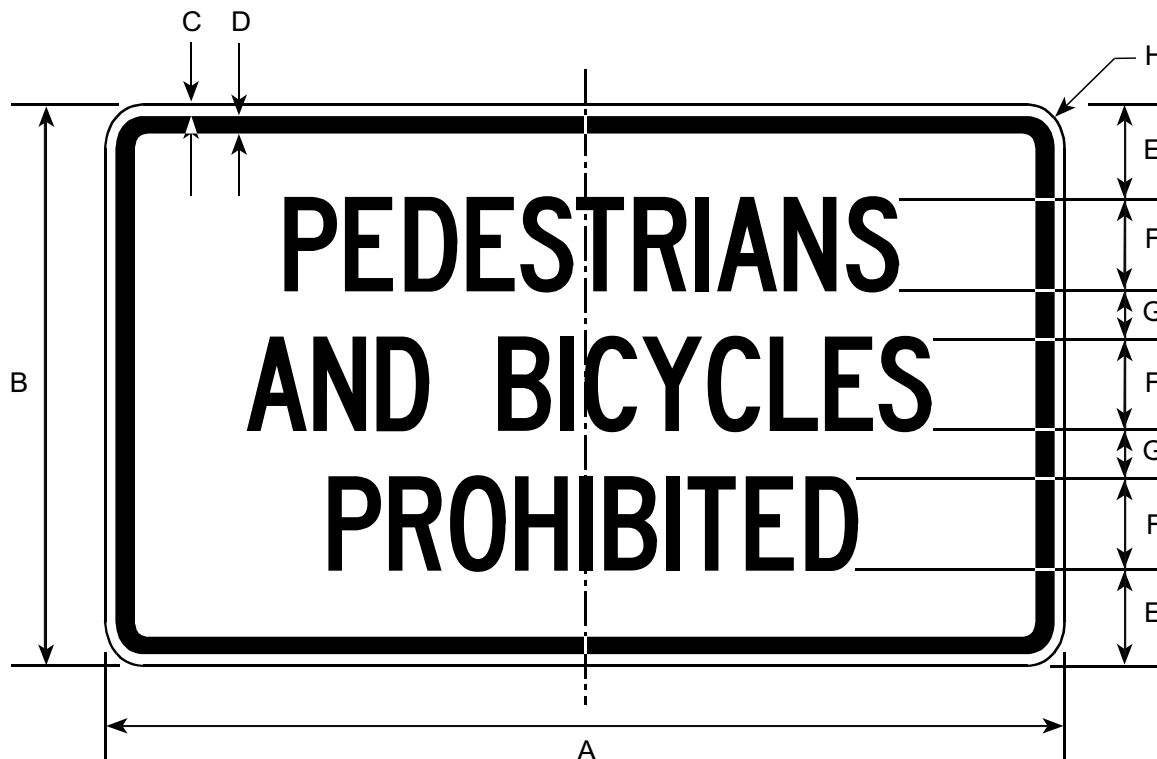

Border and Legend: Black
Background: White

Road Class	Dimensions (inches)							
	A	B	C	D	E	F	G	H
Conv & Min	30	18	0.38	0.63	3	3C	1.50	1.50



Border and Legend: Black
 Background: White

Road Class	Dimensions (inches)							
	A	B	C	D	E	F	G	H
Conv & Min	24	12	0.38	0.63	2.25	3C	1.50	1.50

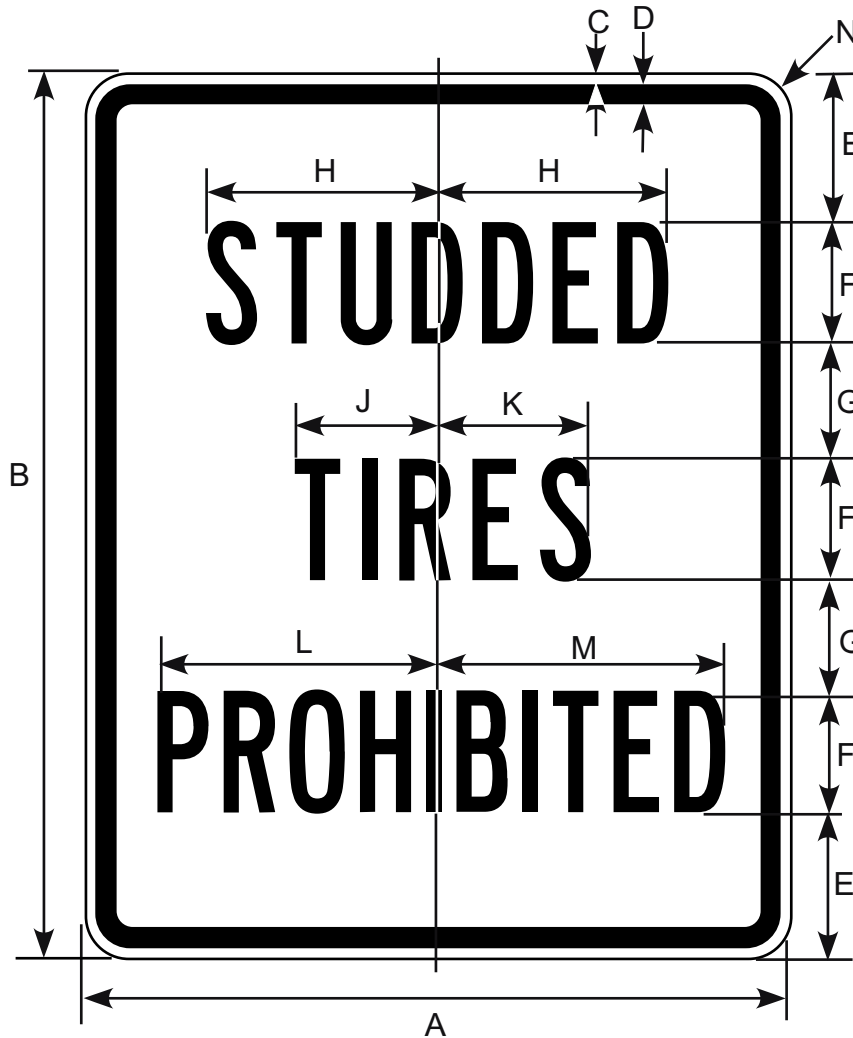

Border and Legend: Black
Background: White

Prior to the 2002 publication of this manual, this sign was numbered R5-5A.

Road Class	Dimensions (inches)												
	A	B	C	D	E	F	G	H	J	K	L	M	N
Minimum	18	24	0.38	0.63	4.25	3B	3.25	6.75	3.63	3.56	7.13	7.25	1.5
Conventional	24	30	0.38	0.63	5.0	4B	4.0	7.75	4.88	4.75	9.5	9.63	1.5
Expressway	36	48	0.63	0.88	8.5	6B	6.5	11.63	7.31	7.13	14.25	14.5	2.25
Freeway	48	60	0.75	1.25	10	8B	8.0	15.5	9.75	9.5	19	19.38	3.0

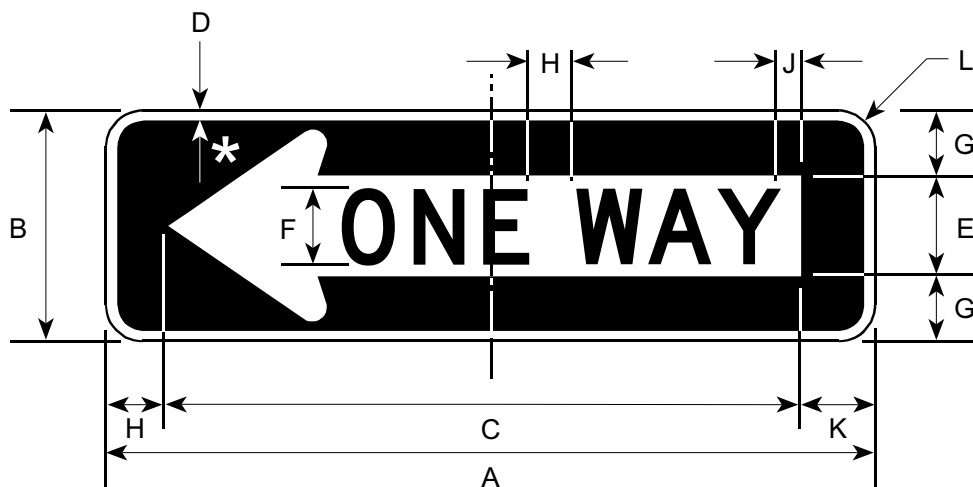

R6-1L

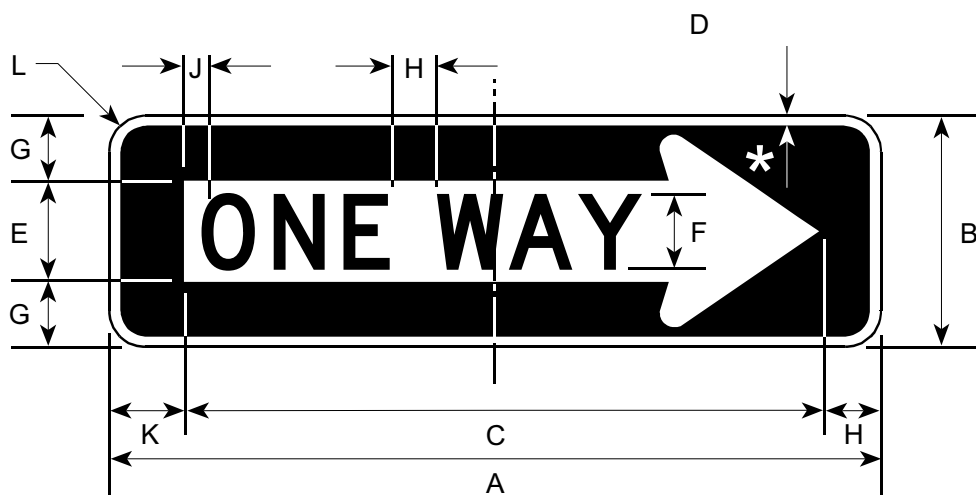

R6-1R

Border and Arrow: White
 Legend and Background: Black

*See Appendix B-1 for Standard Arrow Details.

Road Class	Dimensions (inches)										
	A	B	C	D	E	F	G	H	J	K	L
Conv & Min	36	12	31	0.50	5.24	4D	3.38	2.0	1.25	3.0	1.5
Expwy, Fwy	48	16	41.31	0.63	7.0	5D	4.5	3.0	2.0	3.69	2.0



R6-2R



R6-2L

Border and Legend: Black
Background: White

*See Appendix B-1 for Standard Arrow Details.

Road Class	Dimensions (inches)												
	A	B	C	D	E	F	G	H	J	K	L	M	N
Minimum	18	24	0.38	0.63	2.5	5D	1.5	4.50	5.5	2.25	6.0	5.88	1.5
Conventional	24	30	0.38	0.63	3.0	6D	1.88	6.06	7.06	3.0	8.0	7.75	1.5

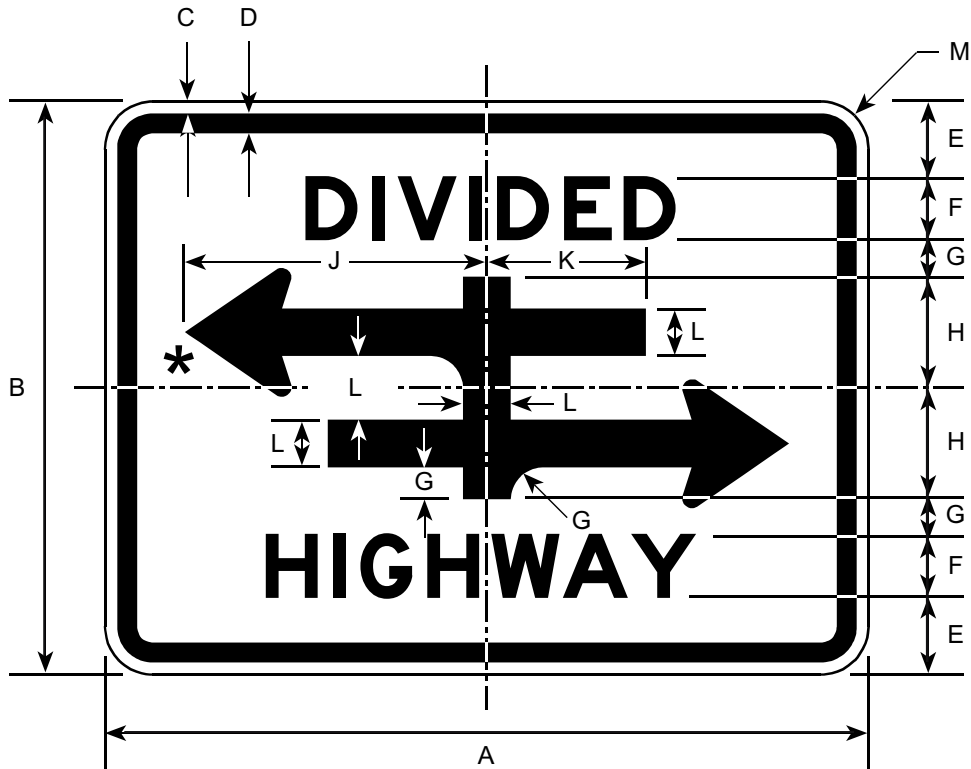

Border and Legend: Black
Background: White

*See Appendix B-1 for Standard Arrow Details.

Road Class	Dimensions (inches)											
	A	B	C	D	E	F	G	H	J	K	L	M
Conv & Min	24	18	0.38	0.63	2.5	2E	1.0	3.5	9.5	5.0	2.0	1.5

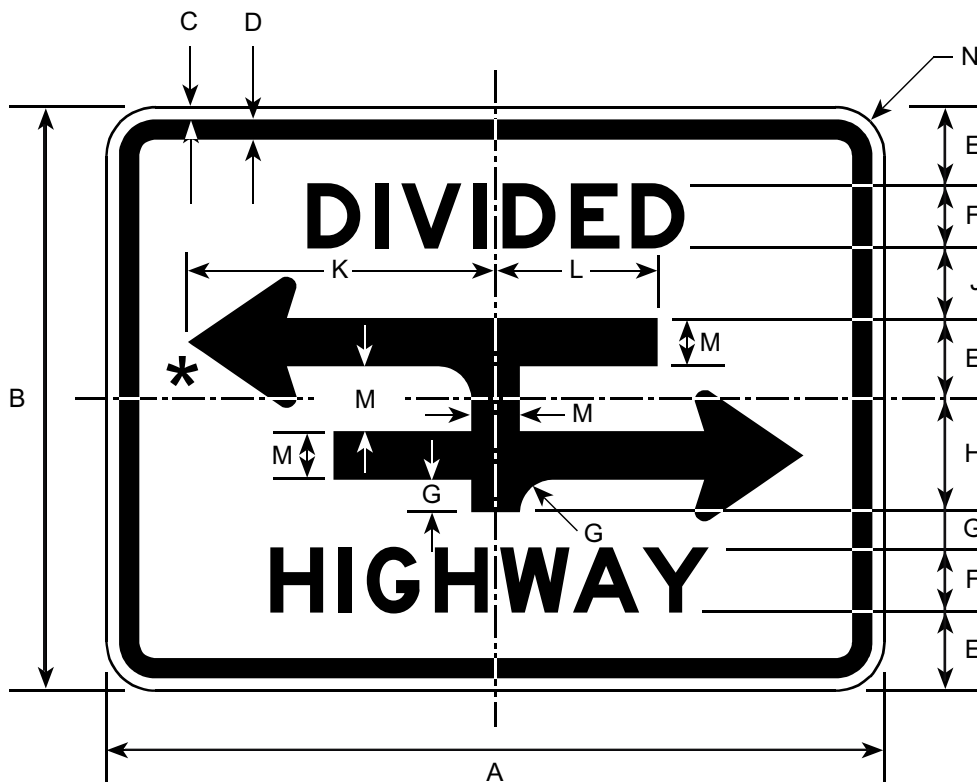

Border and Legend: Black
Background: White

*See Appendix B-1 for Standard Arrow Details.

Road Class	Dimensions (inches)												
	A	B	C	D	E	F	G	H	J	K	L	M	N
Conv & Min	24	18	0.38	0.63	2.5	2E	1.0	3.5	2.0	9.5	5.0	2.0	1.5

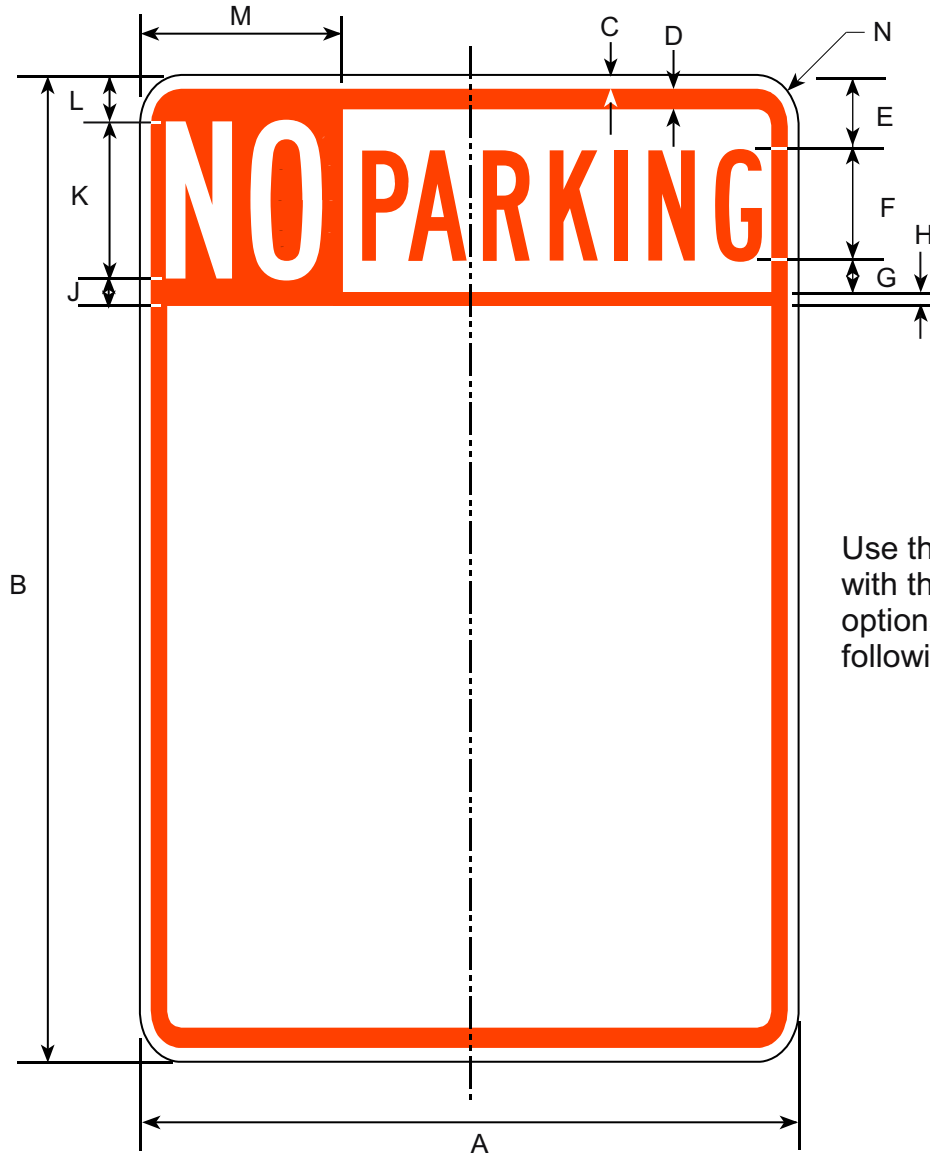

Use this template with the legend options on the following pages

Top Left
Legend: White
Background: Red

Top Right & Bottom
Legend: Red
Background: White

Prior to the 2002 publication of this manual, this sign was numbered R7-.

Road Class	Dimensions (inches)												
	A	B	C	D	E	F	G	H	J	K	L	M	N
Conv & Min	12	18	0.38	0.38	2	2B	1.25	0.25	1.06	3C	1.44	4	1.5

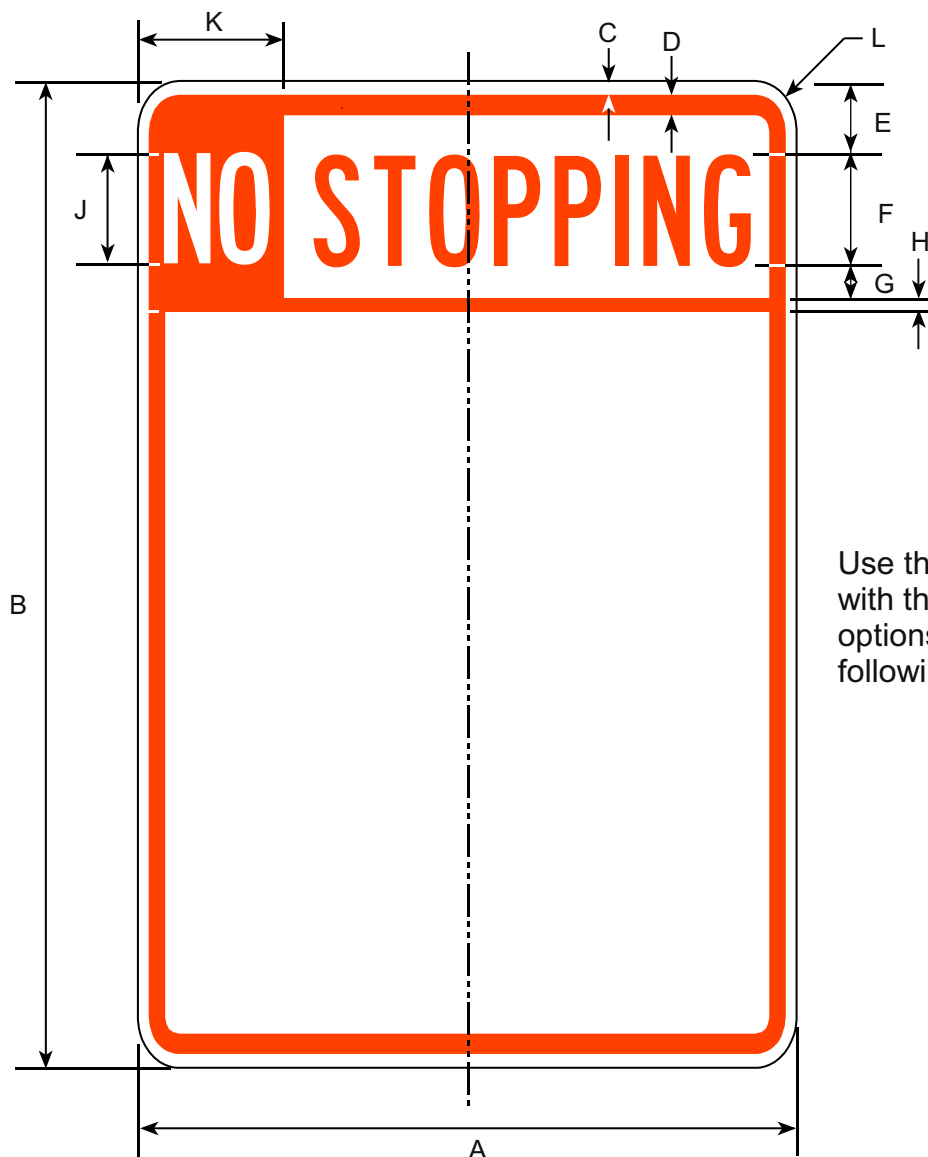

Use this template with the legend options on the following pages

Top Left
Legend: White
Background: Red

Top Right & Bottom
Legend: Red
Background: White

Road Class	Dimensions (inches)										
	A	B	C	D	E	F	G	H	J	K	L
Conv & Mir	12	18	0.38	0.38	2	2B	1.25	0.25	2B	2.5	1.5

Legend Options for R7S & R7P

(1 of 4)

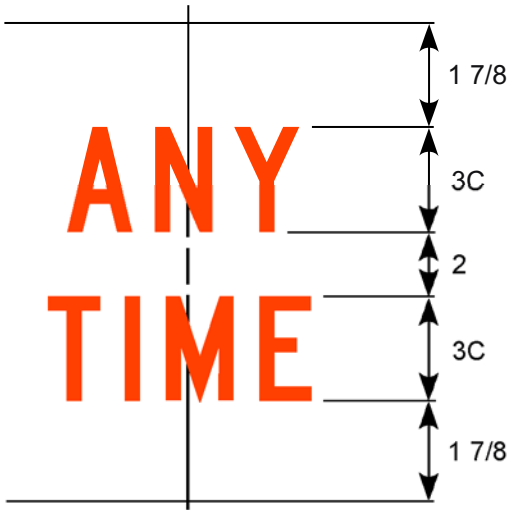

-101

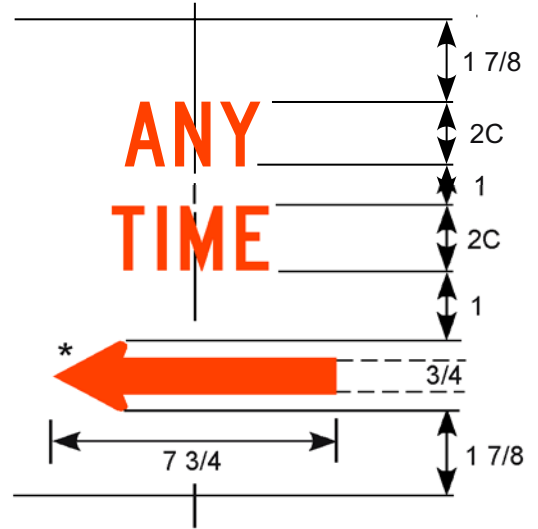

-101L

Reverse arrow for -101R

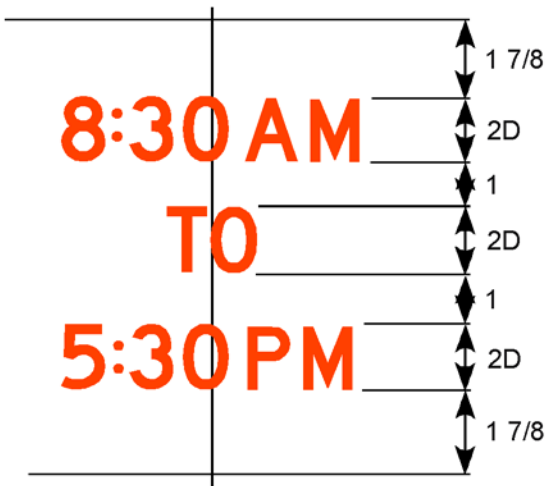

-102

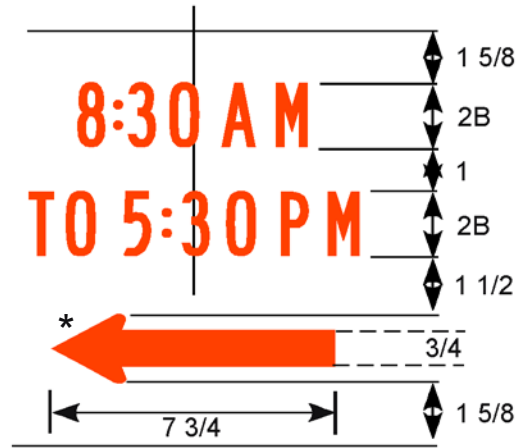

-102L

Reverse arrow for -101L

Legend: Red
Background: White

* See Appendix B-1 for arrow details.

Legend Options for R7S & R7P

(2 of 4)

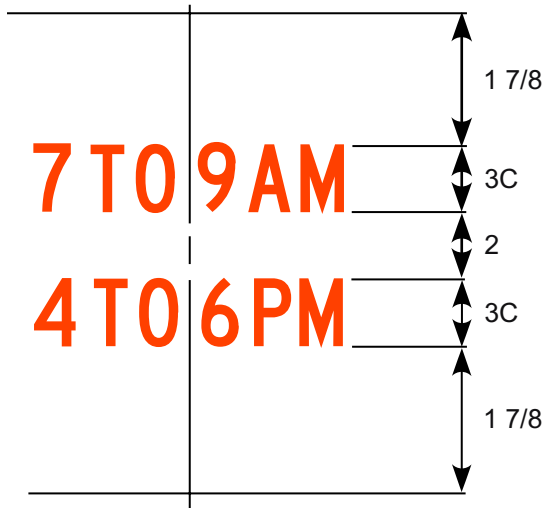

-102A

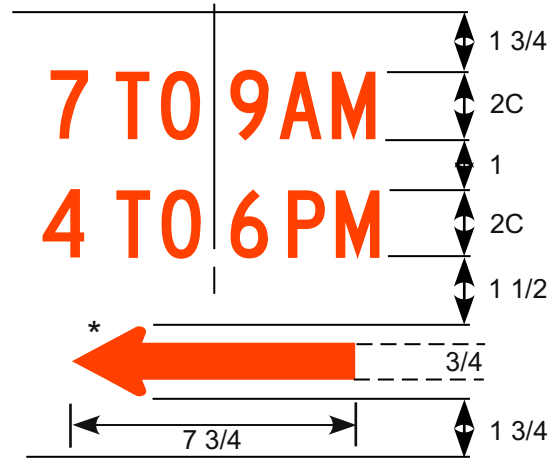

-102AL

Reverse arrow for -102AR

Legend: Red
Background: White

* See Appendix B-1 for standard arrow details.



-103

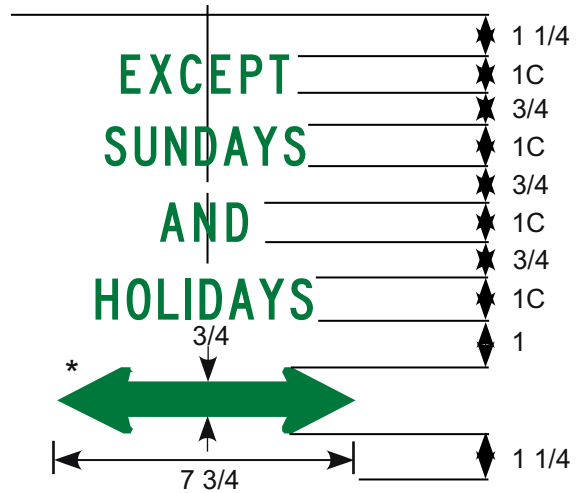

-103RL

Legend: Green
Background: White

* See Appendix B-1 for standard arrow details.

Legend Options for R7S & R7P

(3 of 4)

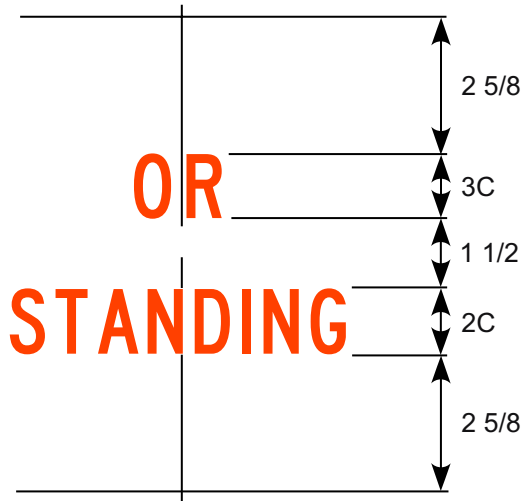

-104

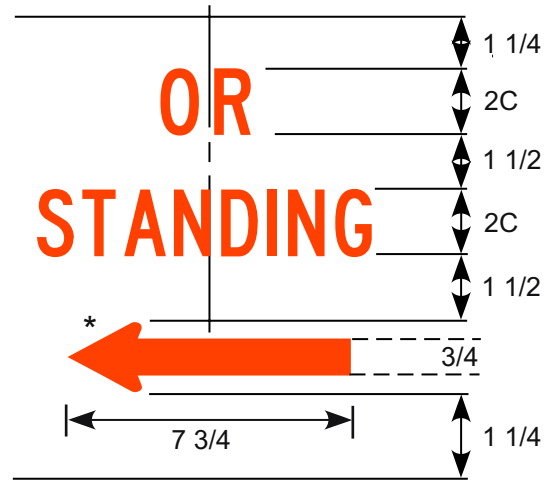

-104L

Reverse arrow for -104R

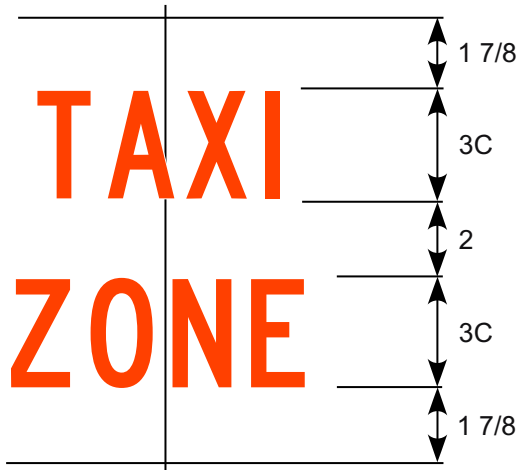

-105

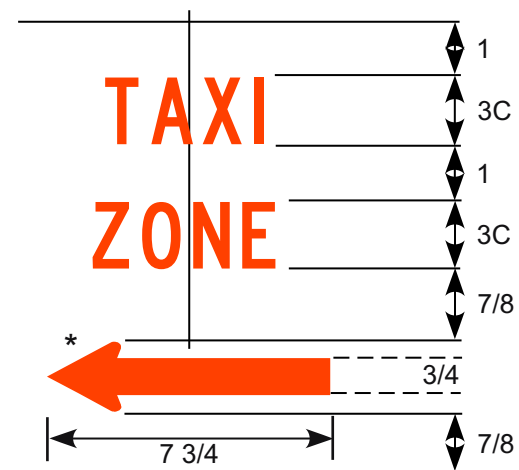

-105L

Reverse arrow for -105R

Legend: Red
Background: White

* See Appendix B-1 for arrow details.

Legend Options for R7S & R7P

(4 of 4)

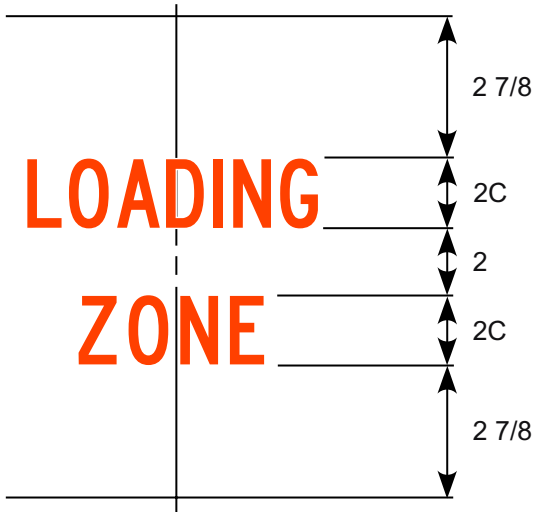

-106

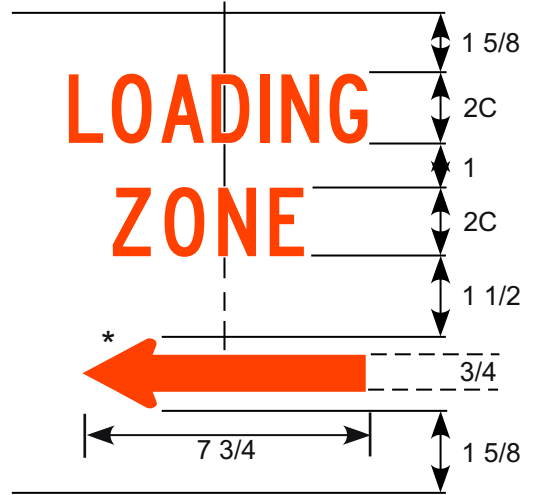

-106L

Reverse arrow for -106R

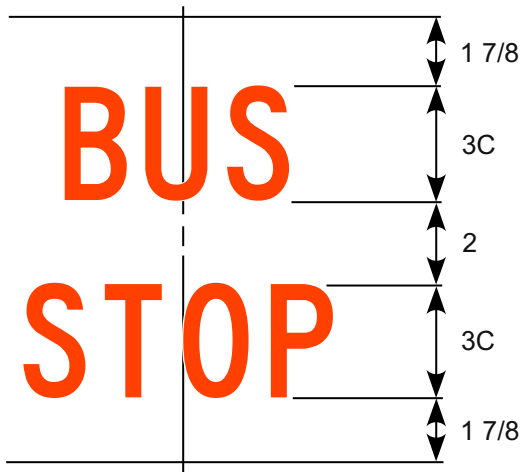

-107

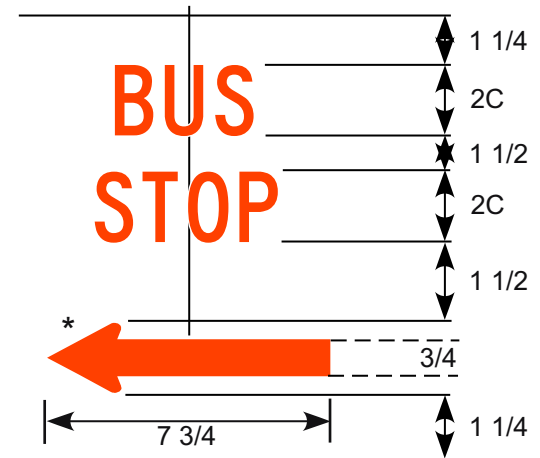

-107L

Reverse arrow for -107R

Legend: Red
Background: White

* See Appendix B-1 for arrow details.



R7-8RL

Border, Arrow, and Legend: Green
 White Symbol on Blue Background
 Background: White

- * Make the symbol proportional to the one shown.
- ** See Appendix B-1 for standard arrow details.

Code	Arrow Options:
R7-8	No Arrow
R7-8L	Left
R7-8R	Right
R7-8RL	Right and Left

Road Class	Dimensions (inches)												
	A	B	C	D	E	F	G	H	J	K	L	M	N
Conv & Min	12	18	0.38	0.63	2C	1.5	1.0	2.5	7.75	6.0	1.75	0.75	1.5

R7-8A

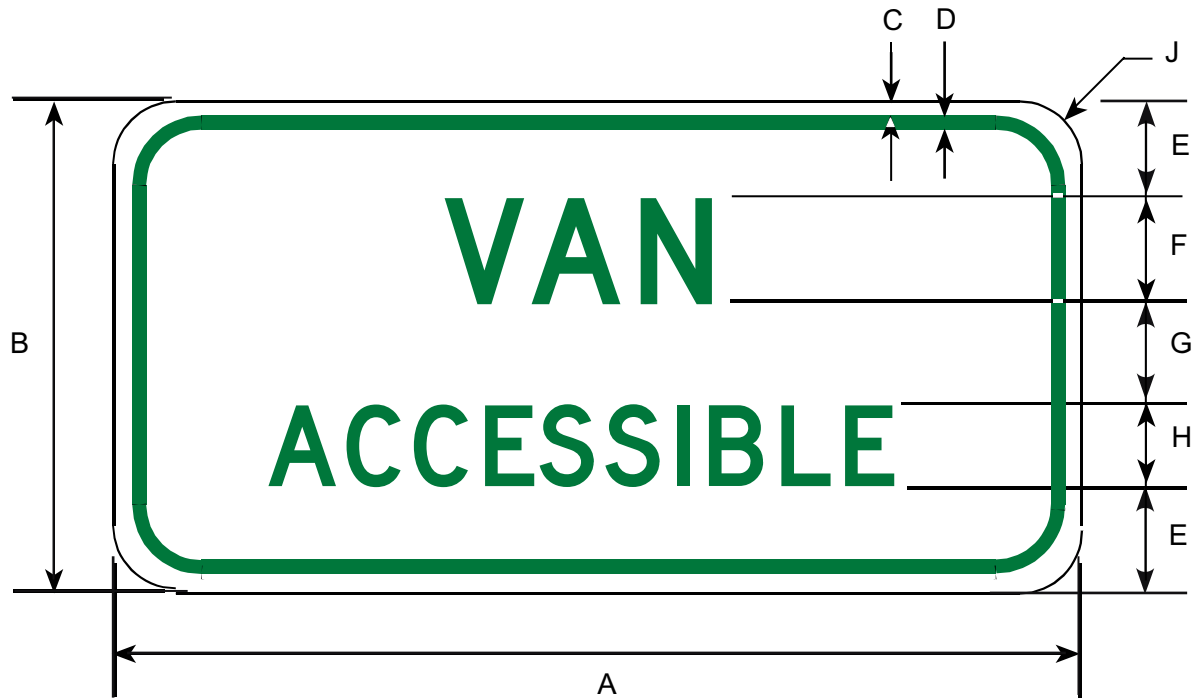

PARKING APPLICATION
 Border and Legend: Green or Black
 Background: White



DESTINATION APPLICATION
 Border and Legend: White
 Background: Blue

Road Class	Dimensions (inches)								
	A	B	C	D	E	F	G	H	J
Minimum	12	6	0.38	0.44	1.50	1.5D	0.5	1.0D	1.5
Conventional	18	9	0.38	0.44	2.25	2.0D	1.0	1.5D	1.5

R7-9A



Symbol: Black
Background: White
Legend, Circle, Diagonal, and Border: Red

R7-107A



Legend, Circle, Arrow and Diagonal: Red
Symbols and Logo: Black
Background: White

*See Appendix B-1 for Standard Arrow Details.

R7-108

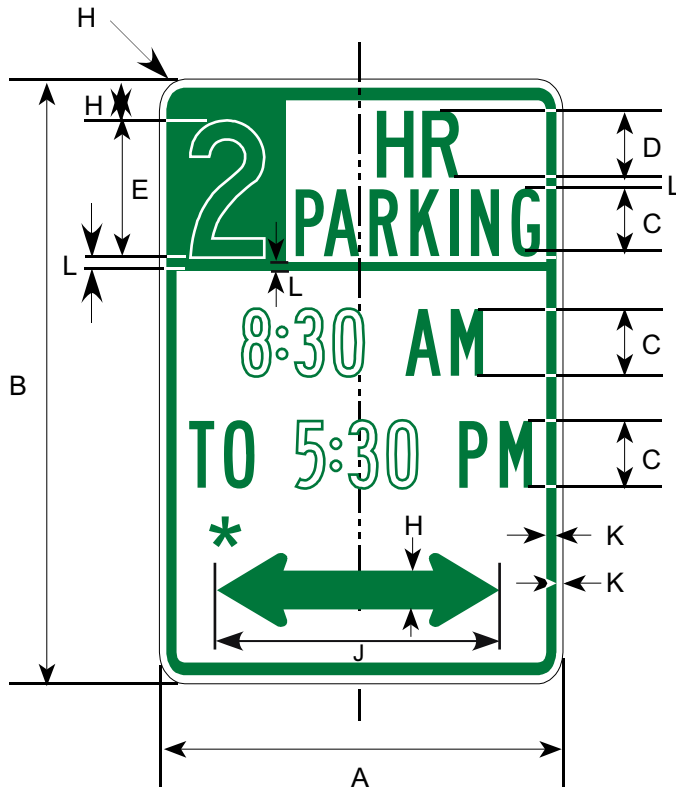

R7-108

Top Left
Legend: White
Background: Green



R7-108A



R7-108B

Top Right & Bottom
Legend: Green
Background: White

Prior to the 2002 publication of this manual, this sign was numbered R7-108B.

*See Appendix B-1 for Standard Arrow Details.

Time is variable

Road Class	Dimensions (inches)										
	A	B	C	D	E	F	G	H	J	K	L
Conv & Min	12	18	2B	2C	4C	3B	2D	0.75	7.75	0.38	0.25

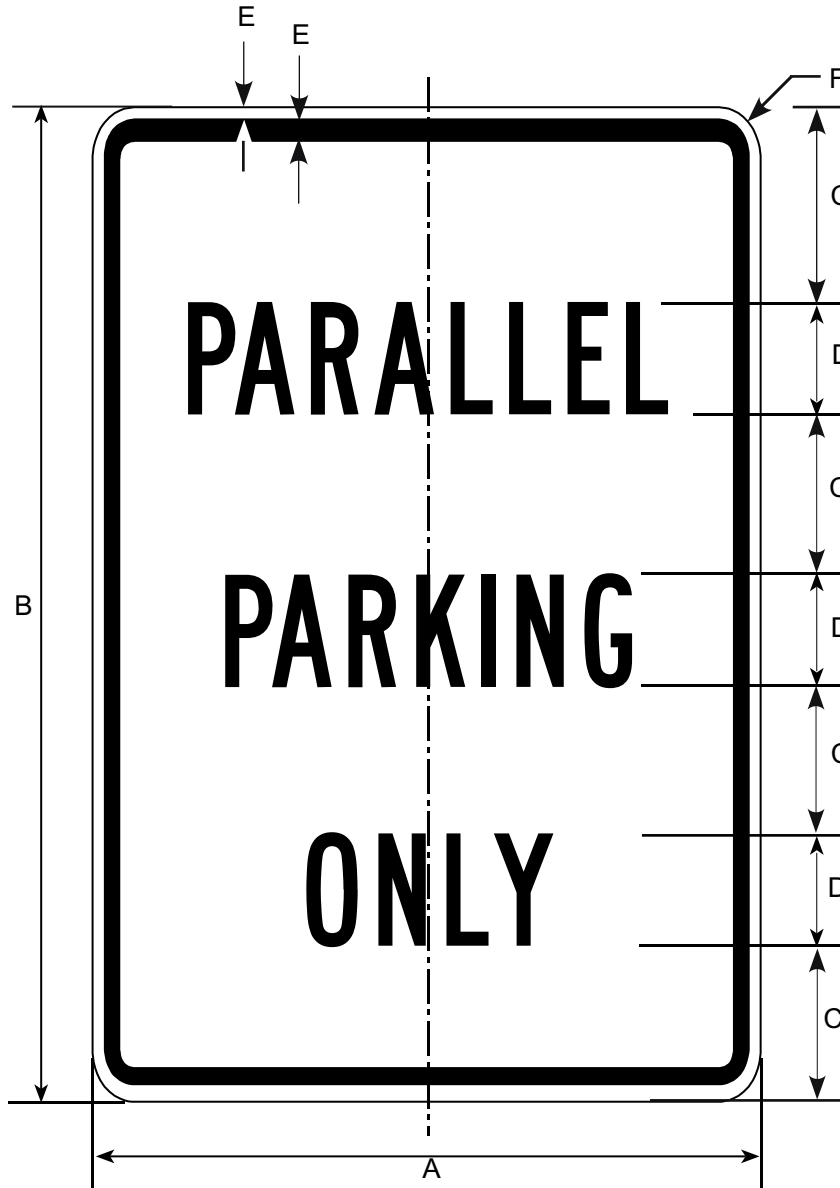

Border and Legend: Black
Background: White

Road Class	Dimensions (inches)					
	A	B	C	D	E	F
Conv & Min	12	18	3	2B	0.38	1.5

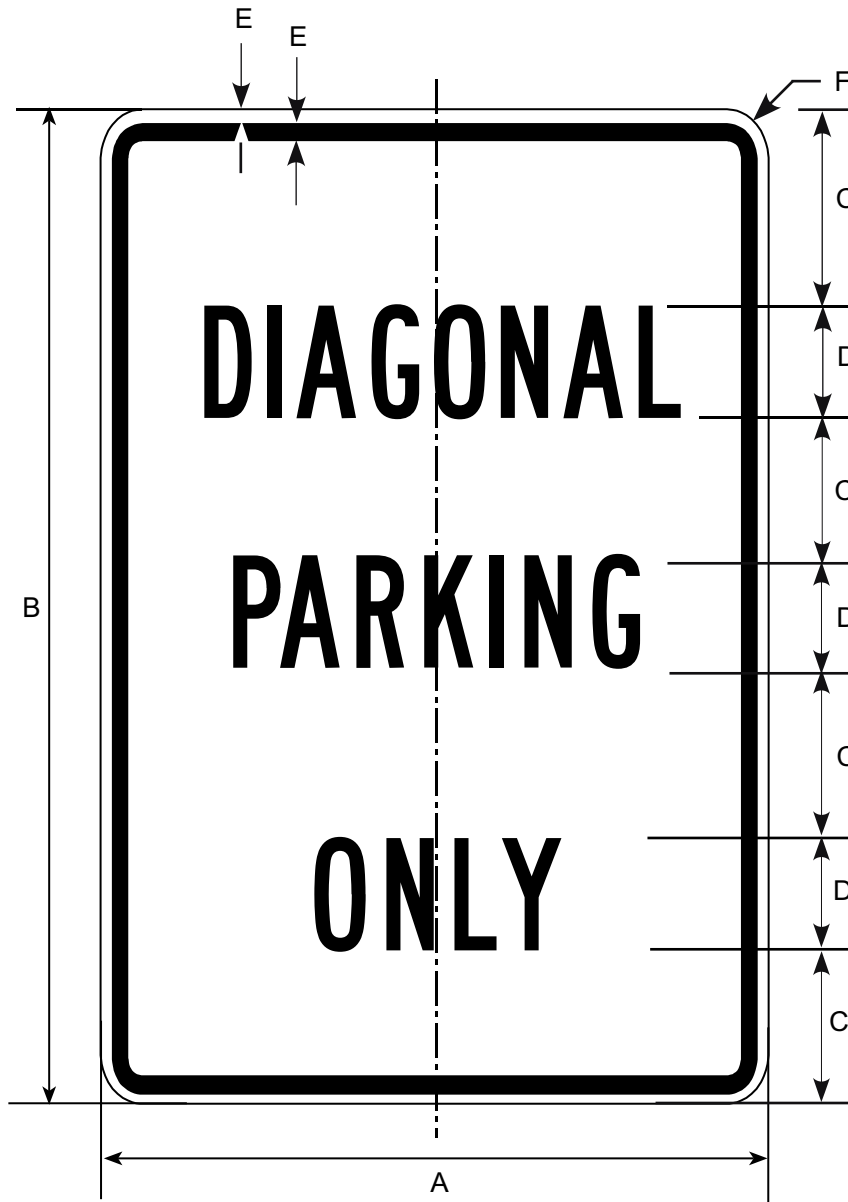

Border and Legend: Black
Background: White

Road Class	Dimensions (inches)					
	A	B	C	D	E	F
Conv & Mii	12	18	3	2B	0.38	1.0



*See Appendix B-1 for Standard Arrow Details.

Border and Legend: Red
Background: White

Border: Red
Legend: Green
Background: White

R7-201
R7-201A
R7-201B

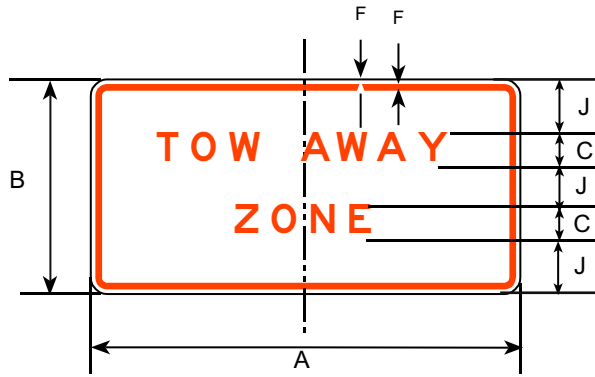

R7-201

Border and Legend: Red
 Background: White

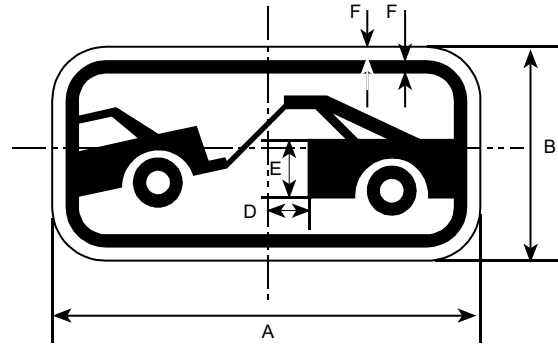

R7-201A

Border and Legend: Black
 Background: White

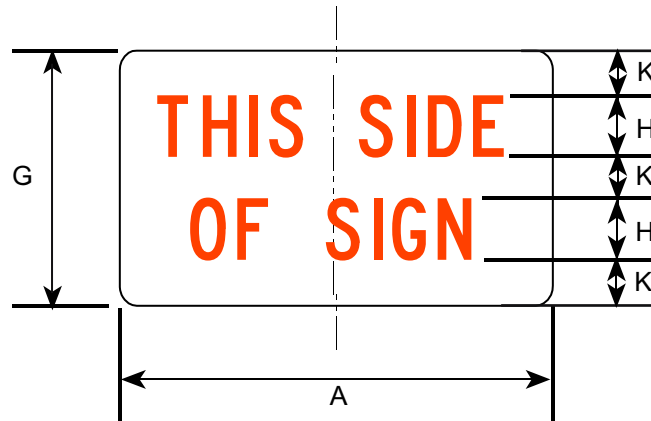

R7-201B

Legend: Red
 Background: White

Prior to the 2002 publication of this manual, this sign was numbered R7-201, R7-201A, R7-202.

Road Class	Dimensions (inches)									
	A	B	C	D	E	F	G	H	J	K
Conv & Min	12	6.0	1E	1.13	1.25	0.38	6.5	2C	1.33	0.67

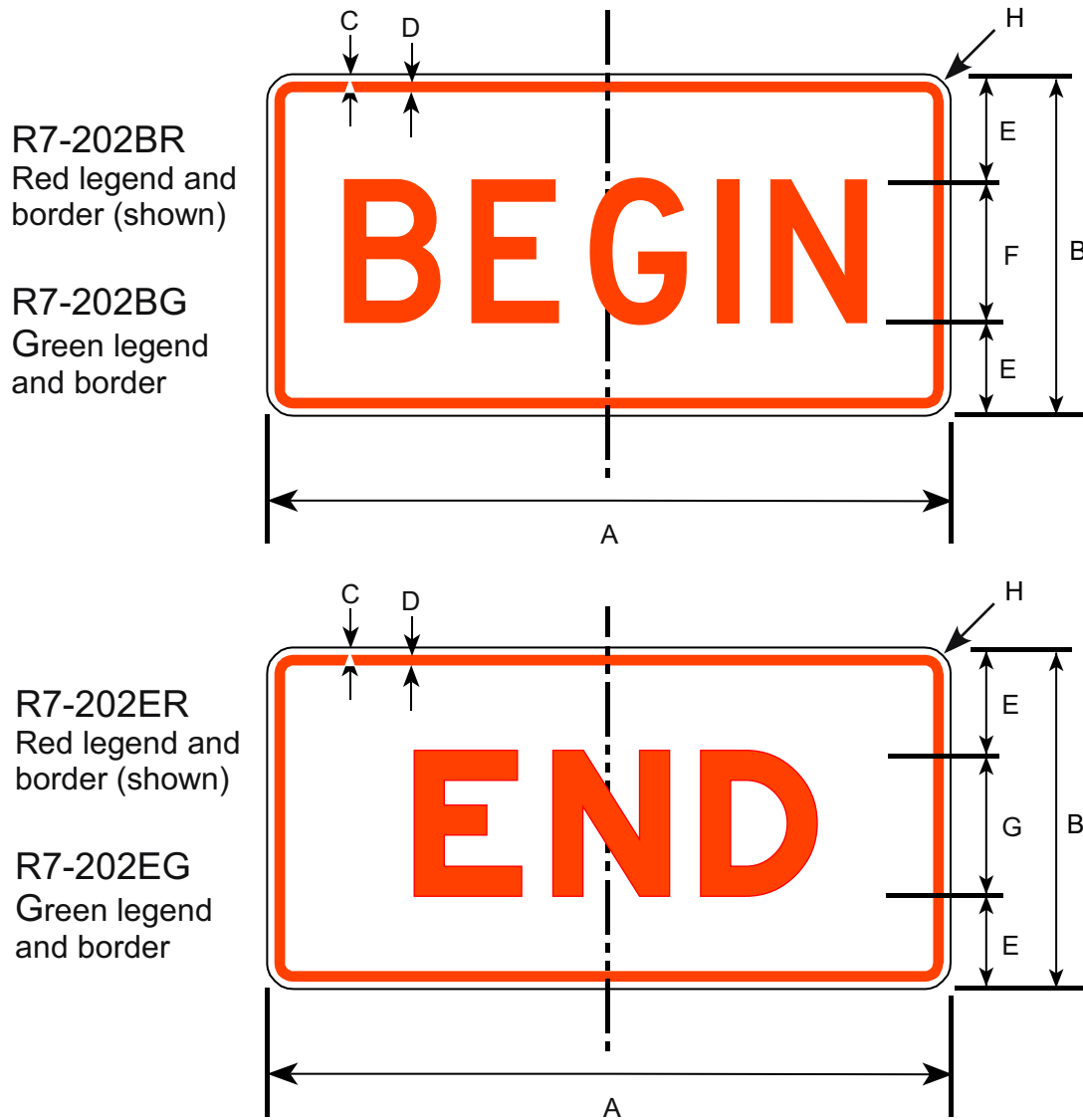

Border and Legend: Should match color of primary sign it is used with.
Background: White

Prior to the 2002 publication of this manual, this sign was numbered R7-202K&M.

Road Class	Dimensions (inches)							
	A	B	C	D	E	F	G	H
Minimum	12	6	0.38	0.38	2.00	2E	2E	1.50
Conventional	24	12	0.38	0.63	3.5	5D	5E	1.50
Expwy, Fwy	36	18	0.38	0.63	5.5	7E	7E	1.88

R7-203



TOP: Legend: White
Background: Red

BOTTOM: Border and Legend: Red
Background: White

Road Class	Dimensions (inches)											
	A	B	C	D	E	F	G	H	J	K	L	M
Conv.	18	24	0.38	0.63	9.81	2.25	2D	1.75	3.5	2C	3	7.69
Oversized	24	30	0.38	0.63	12	2.75	2.5D	2.25	4.81	2.5C	3.19	9.59

N	P	Q	R	S
7.95	6.56	4.18	5.06	1.5
10.09	8.2	5.23	6.32	1.5

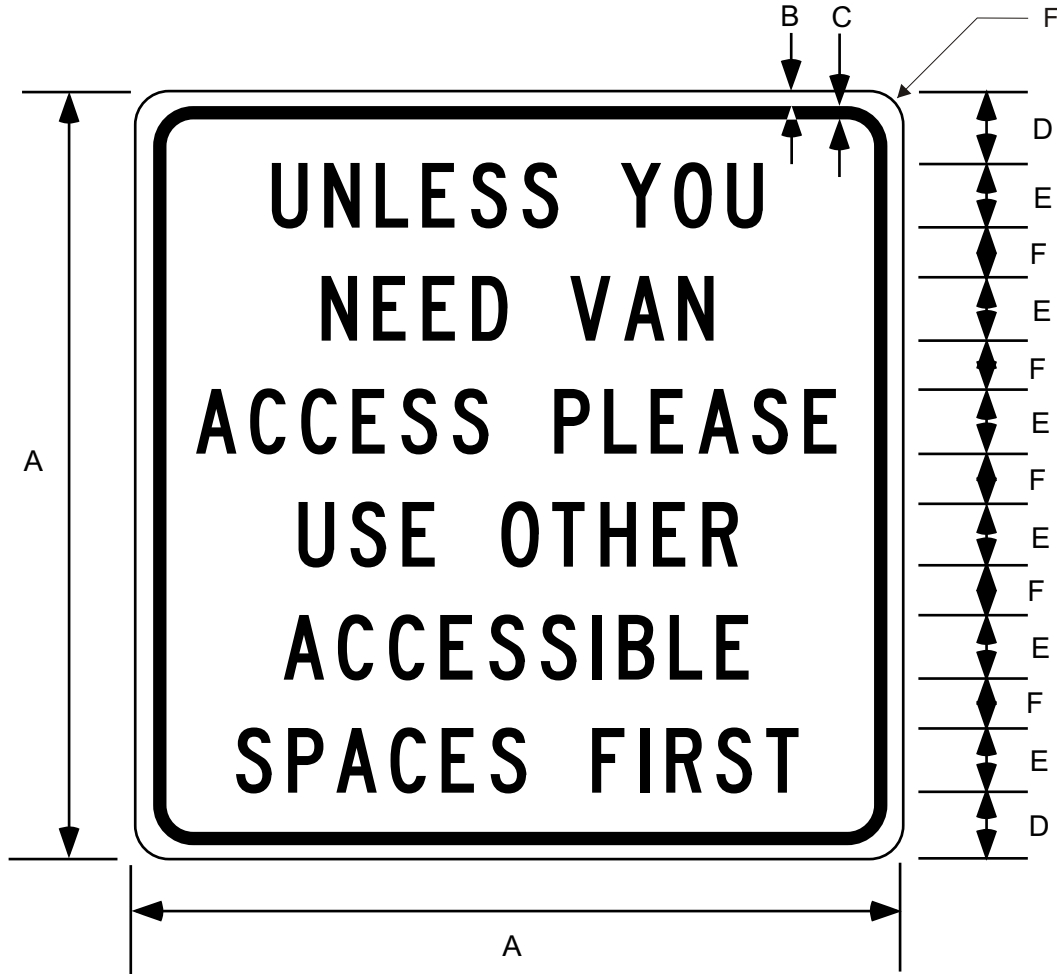

Border and Legend: Black
Background: White

Road Class	Dimensions (inches)					
	A	B	C	D	E	F
Conv & Min	12	0.38	0.38	1.13	1.0C	0.75



Border and Legend: Red
Background: White

Road Class	Dimensions (inches)										
	A	B	C	D	E	F	G	H	J	K	L
Minimum	18	24	0.38	0.63	3.50	3D	2.5	3C	2D	2.0	1.5
Conventional	24	30	0.38	0.63	3.63	5D	2.25	5C	3D	2.25	1.5
Expressway	36	48	0.63	0.88	6.0	7D	4.67	7C	4D	4.0	2.25
Freeway	48	60	0.75	1.25	7.5	9D	5.67	9C	5D	5.0	3.0

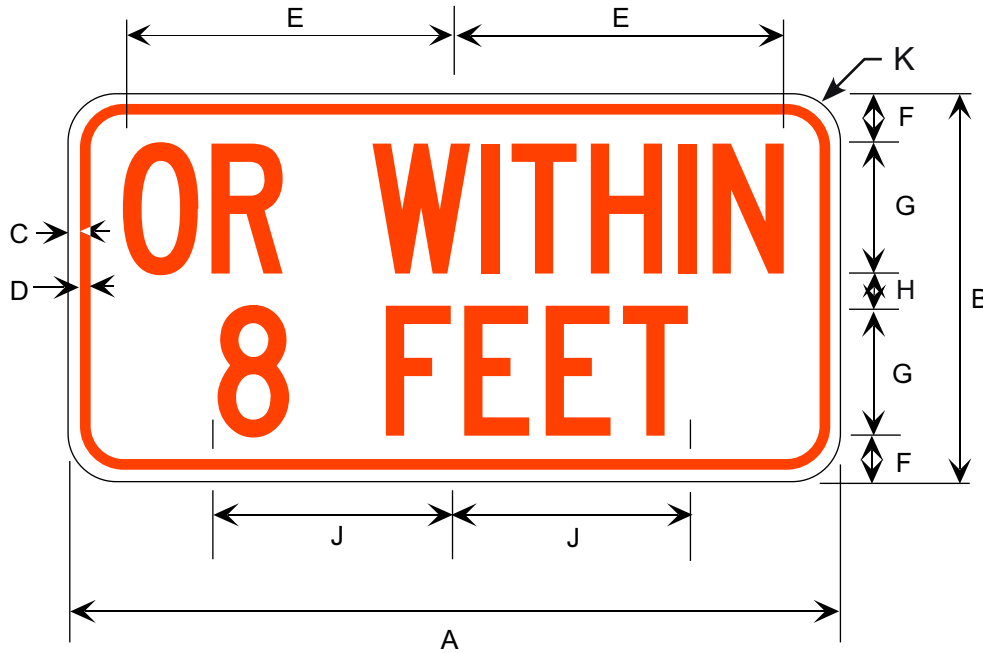

Border and Legend: Red
Background: White

Road Class	Dimensions (inches)									
	A	B	C	D	E	F	G	H	J	K
Conv & Min	24	12	0.38	0.38	10.5	1.5	4C	1	7.5	0.75

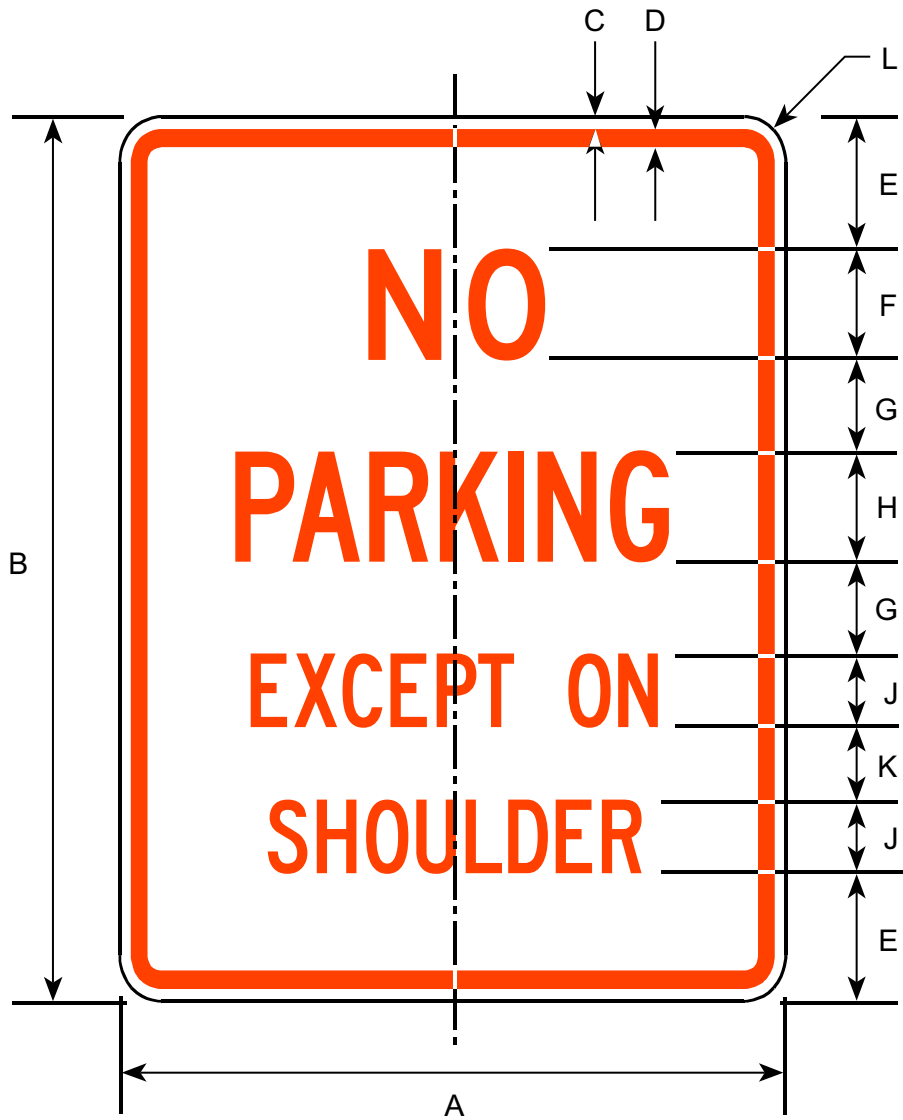

Border and Legend: Red
Background: White

Road Class	Dimensions (inches)										
	A	B	C	D	E	F	G	H	J	K	L
Minimum	18	24	0.38	0.63	3.5	3D	2.5	3C	2C	2.0	1.5
Conventional	24	30	0.38	0.63	3.63	5D	2.25	5C	3C	2.25	1.5
Expressway	36	48	0.63	0.88	6.0	7D	5.0	7C	4C	4.0	2.25
Freeway	48	60	0.75	1.25	7.5	9D	6.0	9C	5C	5.0	3.0

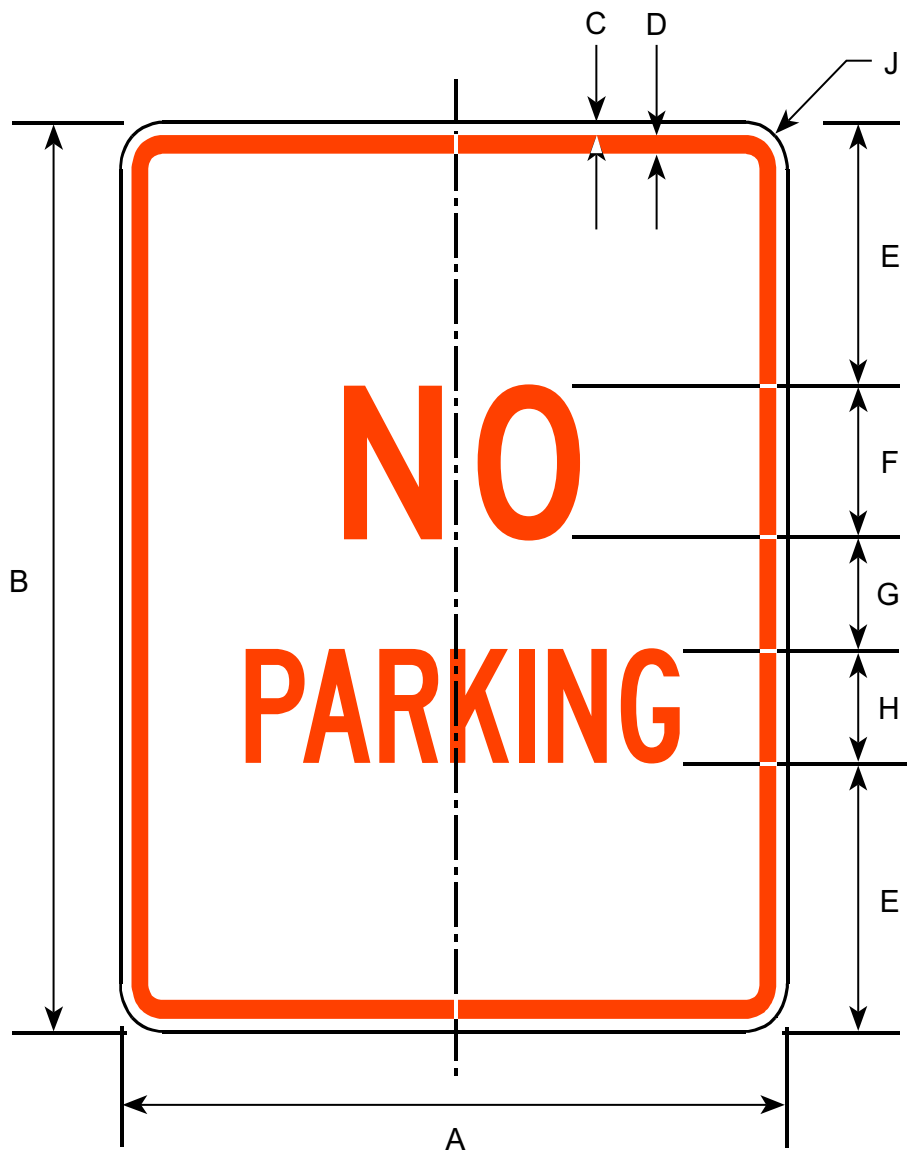

Border and Legend: Red
Background: White

Road Class	Dimensions (inches)								
	A	B	C	D	E	F	G	H	J
Minimum	18	24	0.38	0.63	7.00	4D	3.0	3C	1.50
Conventional	24	30	0.38	0.63	7.25	6D	4.5	5C	1.50
Expressway	36	48	0.63	0.88	7.50	8D	6.0	7C	2.25
Freeway	48	60	0.75	1.25	10.50	10D	8.0	9C	3.00

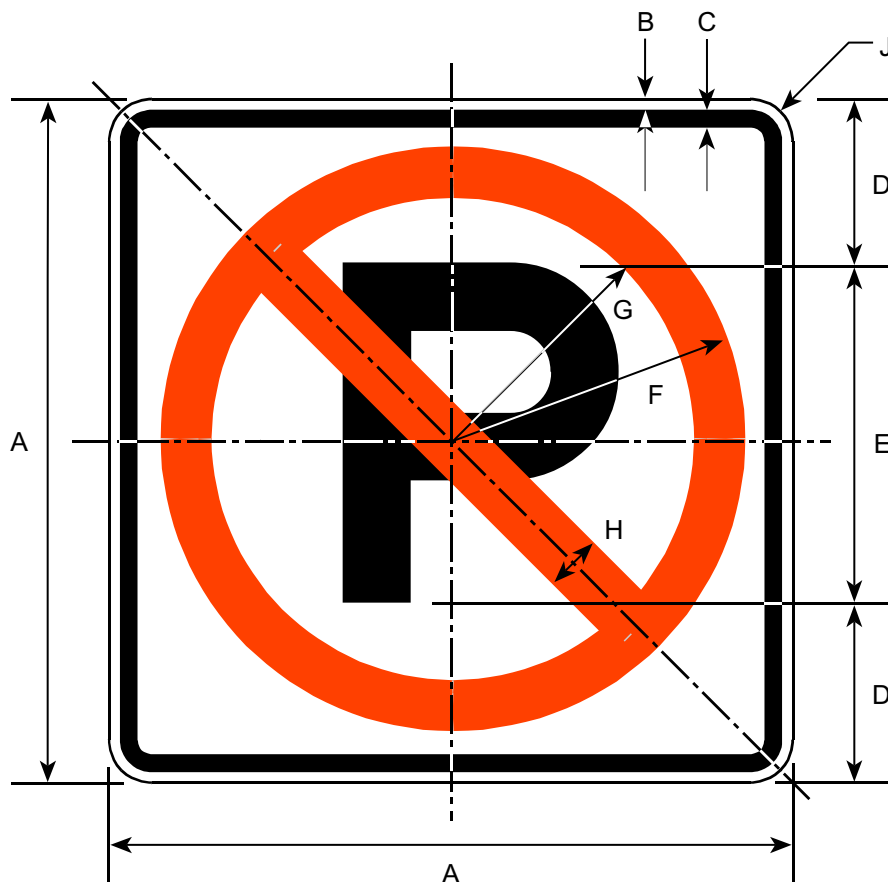

Circle & Diagonal: Red
 Symbol & Border: Black
 Background: White

Road Class	Dimensions (inches)								
	A	B	C	D	E	F	G	H	J
Minimum	18	0.38	0.38	4.5	9E(M)	4.88	3.88	1.00	1.50
Conventional	24	0.38	0.63	6	12E(M)	10.50	8.50	2.50	1.50
Expressway	36	0.63	0.88	9	18E(M)	15.75	12.75	3.00	2.25
Freeway	48	0.75	1.25	12	24E(M)	21.00	17.00	4.00	3.00

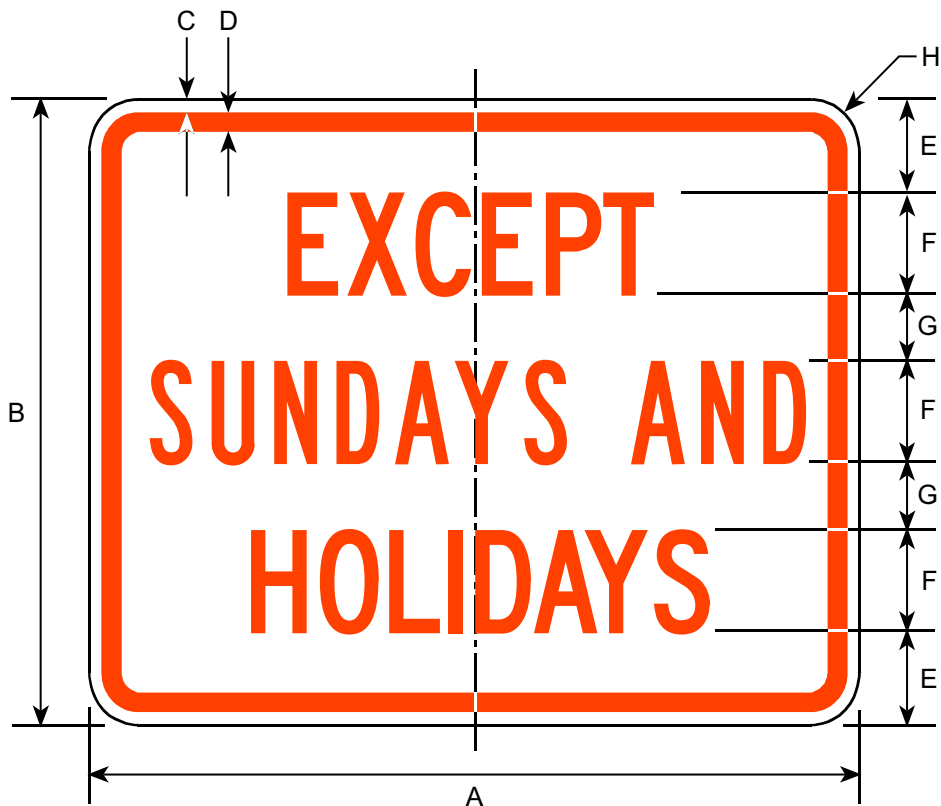

Border and Legend: Red
Background: White

OTHER TYPICAL LEGENDS

**ON
TRACKS**

**ON
BRIDGE**

**ON
PAVEMENT**

**6 AM
TO 6 PM**

**EXCEPT ON
SHOULDERS**

**LOADING
ZONE**



See drawings R7S-102L and R7S-103RL for arrow details.

Prior to the 2002 publication of this manual, this sign was numbered R8-30.

Road Class	Dimensions (inches)							
	A	B	C	D	E	F	G	H
Minimum	12	VAR	0.38	0.38	VAR	VAR	VAR	1.5
Conventional	24	VAR	0.38	0.63	VAR	VAR	VAR	1.5

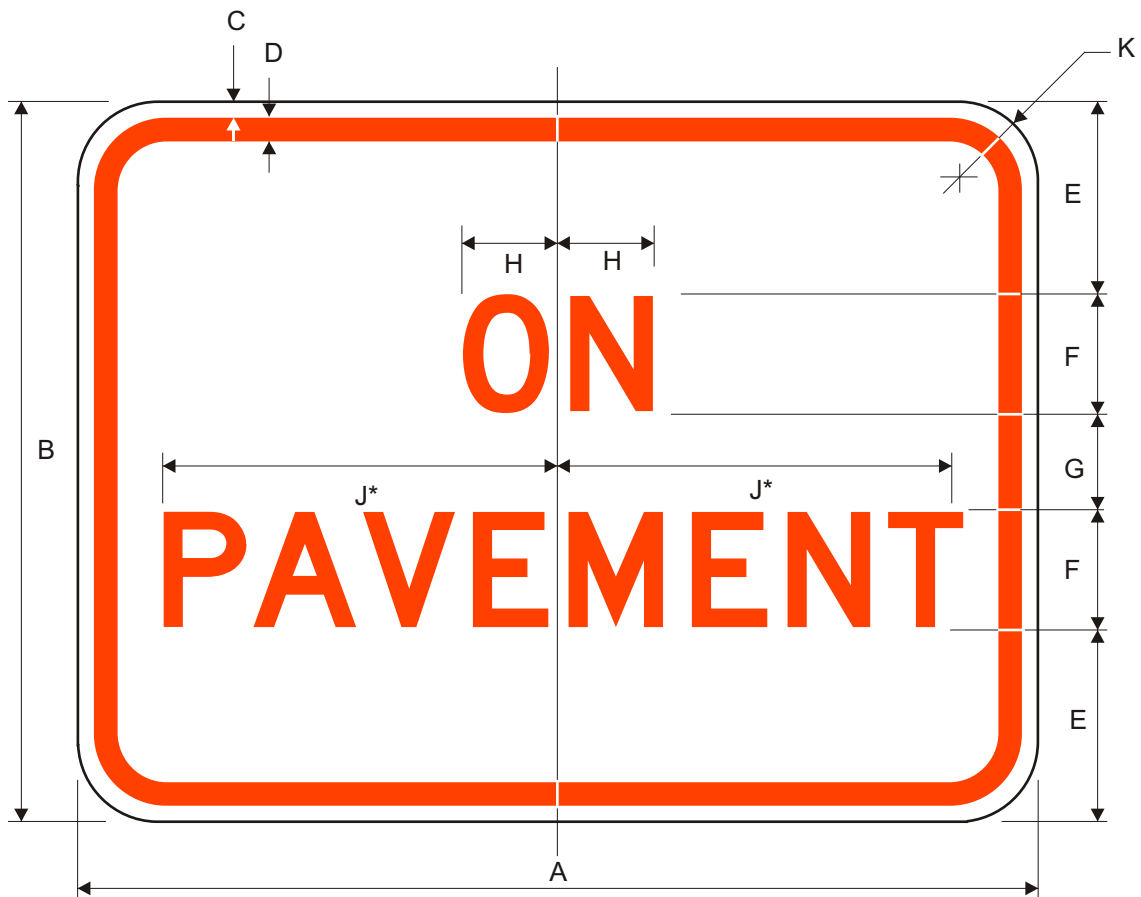

*Reduce spacing to fit for 30" size.

Border and Legend: Red
Background: White

Road Class	Dimensions (inches)									
	A	B	C	D	E	F	G	H	J	K
Minimum	18	12	0.38	0.63	3.0	2D	2.0	1.61	6.59	1.5
Conventional	24	18	0.38	0.63	4.75	3D	2.5	2.41	9.88	1.5
Expy/Fwy	30	24	0.5	0.75	6.0	4D	4.0	3.21	12.84	1.88

R8-3D

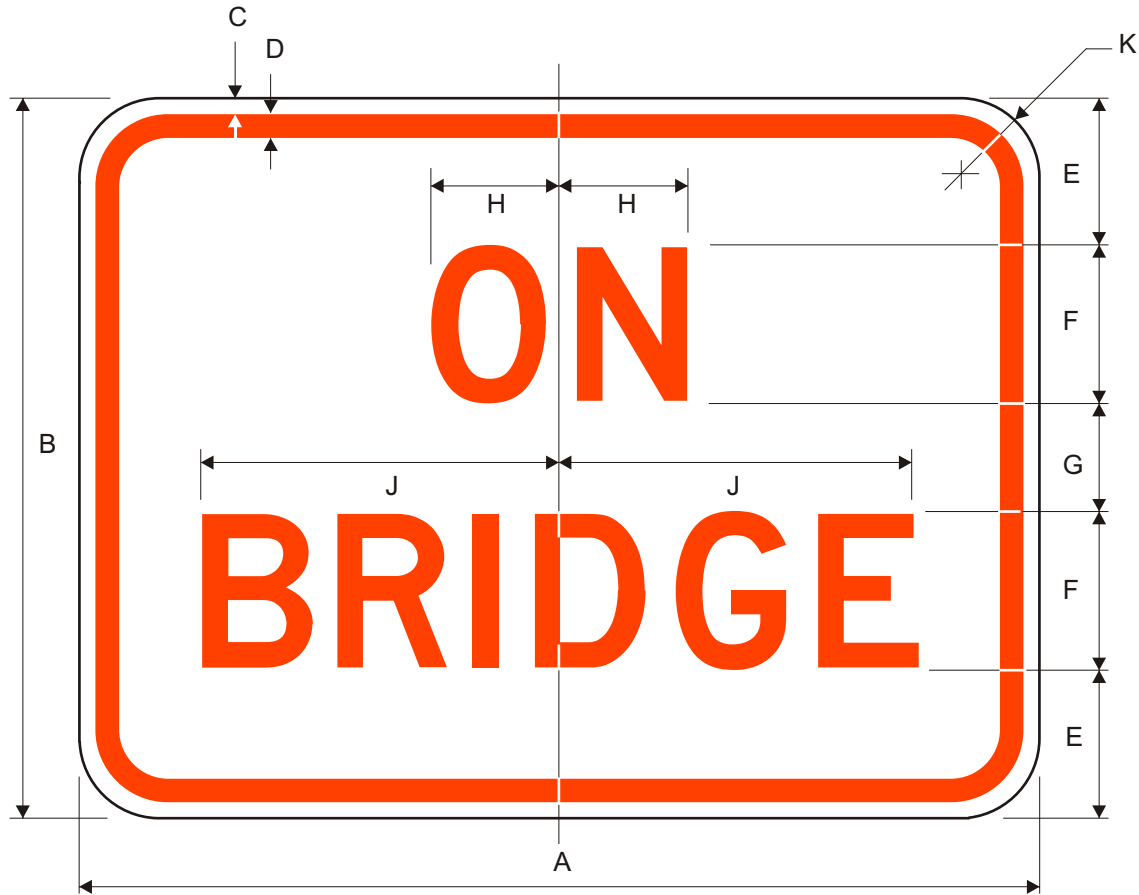

Border and Legend: Red
Background: White

Road Class	Dimensions (inches)									
	A	B	C	D	E	F	G	H	J	K
Minimum	18	12	0.38	0.63	2.0	3D	2.0	2.41	6.72	1.5
Conventional	24	18	0.38	0.63	3.75	4D	2.5	3.21	8.96	1.5
Expy/Fwy	30	24	0.50	0.75	5.0	5D	4.0	4.02	11.21	1.88



Border and Legend: Black
 Background: White

Road Class	Dimensions (inches)								
	A	B	C	D	E	F	G	H	J
Expressway	30	24	0.38	0.63	3.50	4C	2.50	4D	1.50
Freeway	48	36	0.63	0.88	5.00	6C	4.00	6D	2.25

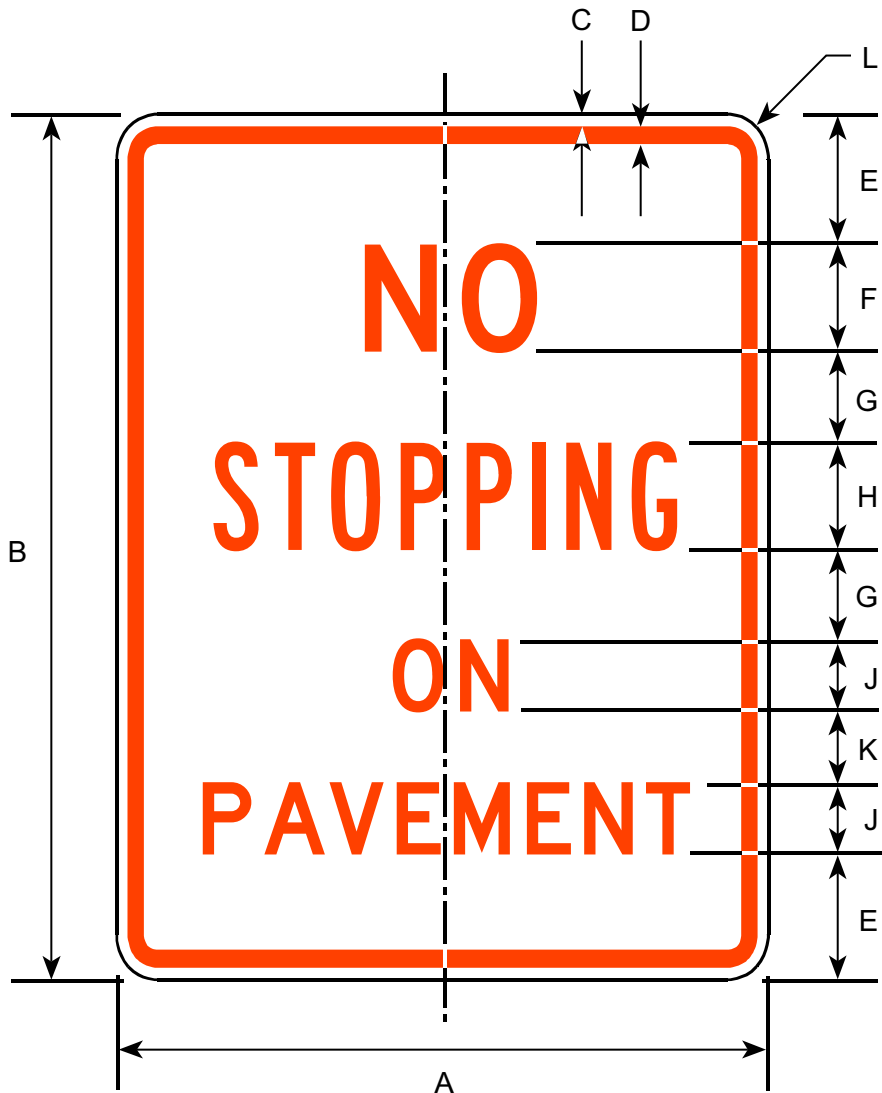

Border and Legend: Red
Background: White

Road Class	Dimensions (inches)										
	A	B	C	D	E	F	G	H	J	K	L
Minimum	18	24	0.38	0.63	3.50	3D	2.50	3B	2D	2.00	1.50
Conventional	24	30	0.38	0.63	3.63	5D	2.25	5B	3D	2.25	1.50
Expressway	36	48	0.63	0.88	6.00	7D	5.00	7B	4D	4.00	2.25
Freeway	48	60	0.75	1.25	7.50	9D	6.00	9B	5D	5.00	3.00

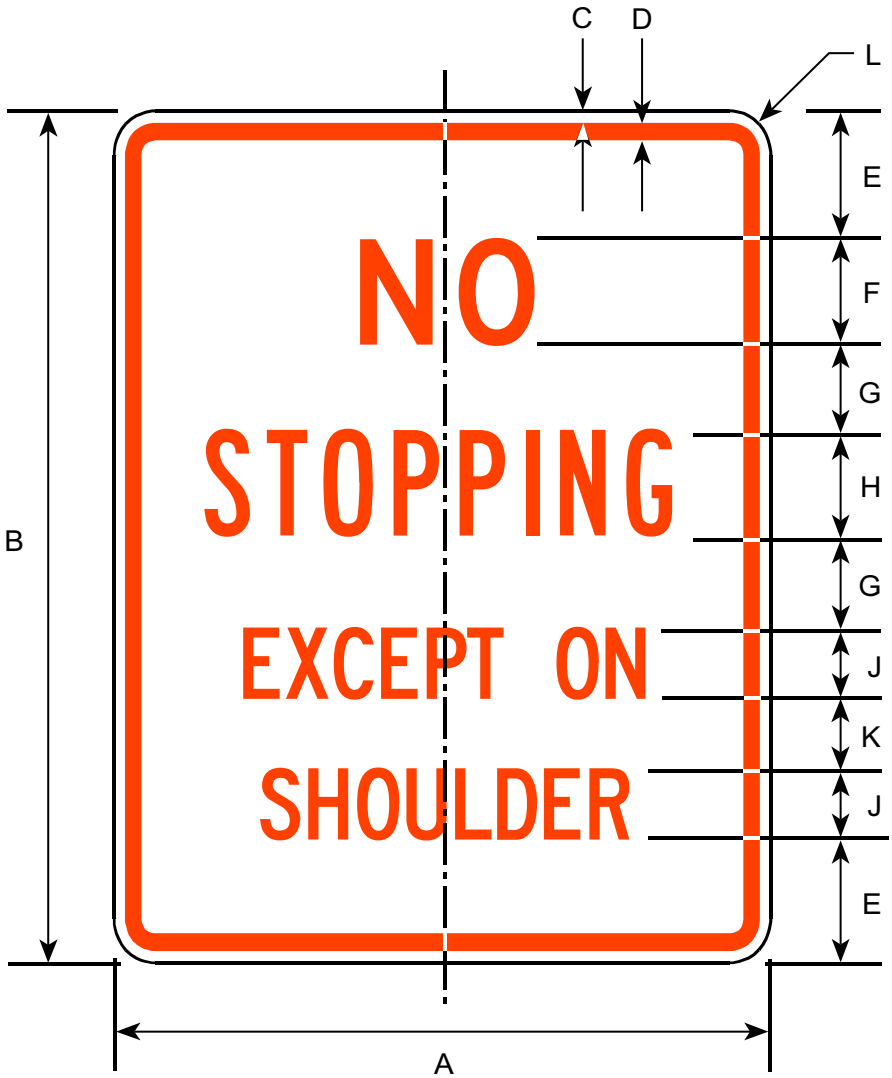

Border and Legend: Red
 Background: White

Road Class	Dimensions (inches)										
	A	B	C	D	E	F	G	H	J	K	L
Minimum	18	24	0.38	0.63	3.50	3D	2.50	3B	2C	2.00	1.50
Conventional	24	30	0.38	0.63	3.63	5D	2.25	5B	3C	2.25	1.50
Expressway	36	48	0.63	0.88	6.00	7D	5.00	7B	4C	4.00	2.25
Freeway	48	60	0.75	1.25	7.50	9D	6.00	9B	5C	5.00	3.00



Border and Legend: Black
 Background: White

Road Class	Dimensions (inches)									
	A	B	C	D	E	F	G	H	J	
Expressway	30	24	0.38	0.63	3.50	4C	2.50	4D	1.50	
Freeway	48	36	0.63	0.88	5.00	6C	4.00	6D	2.25	

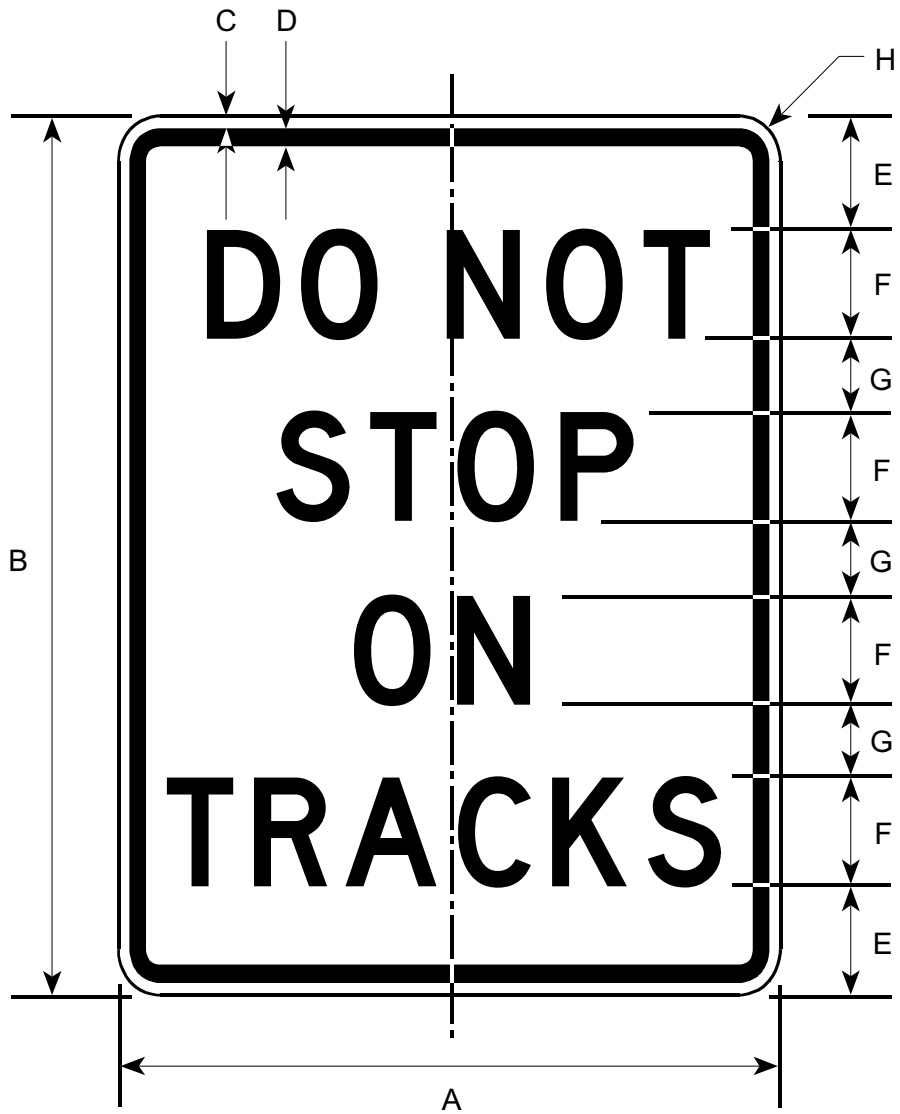

Border and Legend: Black
 Background: White

Road Class	Dimensions (inches)							
	A	B	C	D	E	F	G	H
Minimum	24	30	0.38	0.63	3.63	4D	2.25	1.50
Conventional	36	48	0.63	0.88	6.00	6D	4.00	2.25
Expwy/Frwy	48	60	0.75	1.25	7.25	8D	4.50	3.00

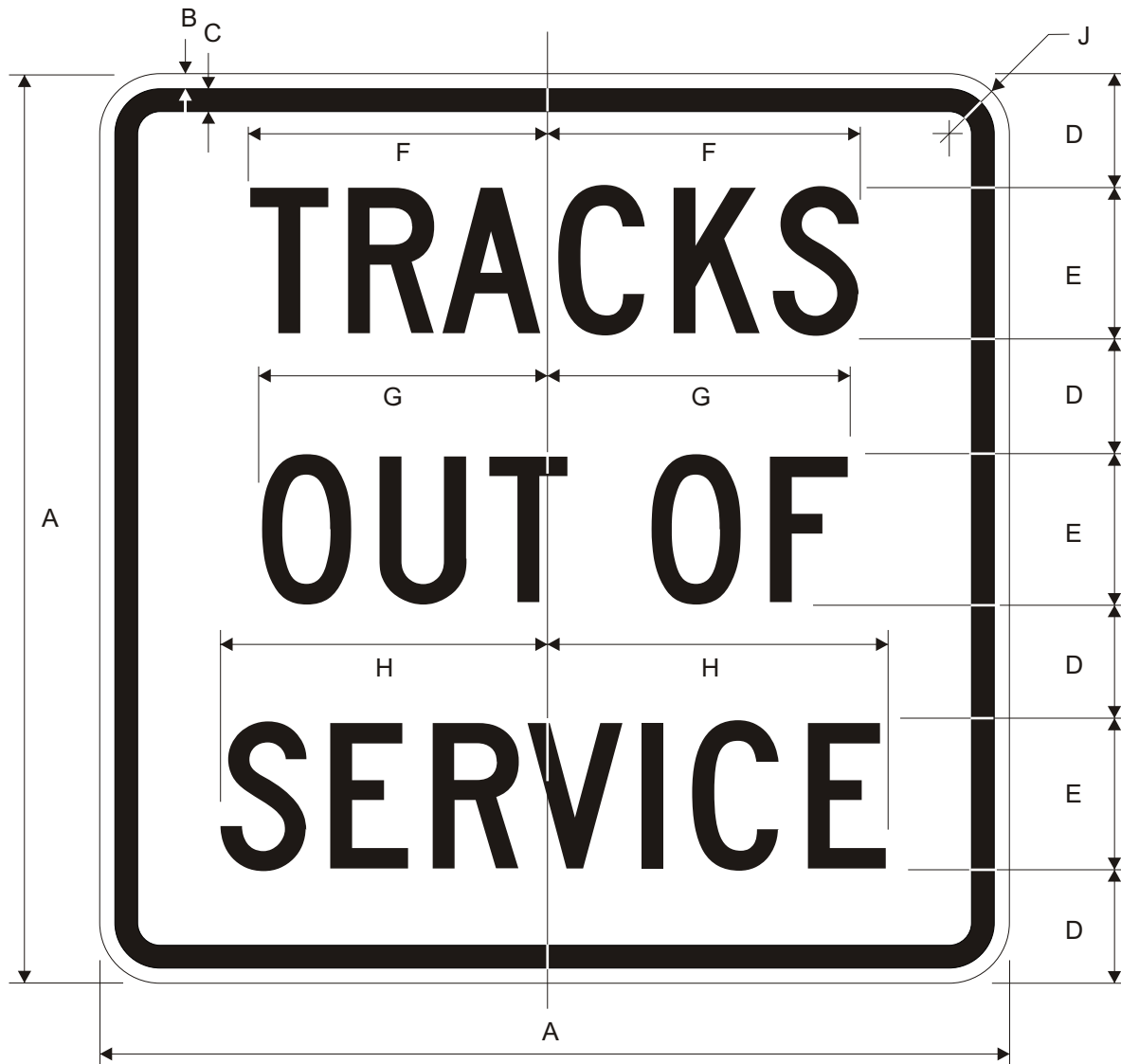

Border and Legend: Black
 Background: White

Road Class	Dimensions (inches)								
	A	B	C	D	E	F	G	H	J
Bike	18	0.38	0.63	2.25	3C	6.06	5.86	6.61	1.5
Expy.	36	0.63	0.88	4.5	6C	12.13	11.71	13.23	2.25
Oversized	48	0.75	1.25	6.0	8C	16.17	15.63	17.65	3.0

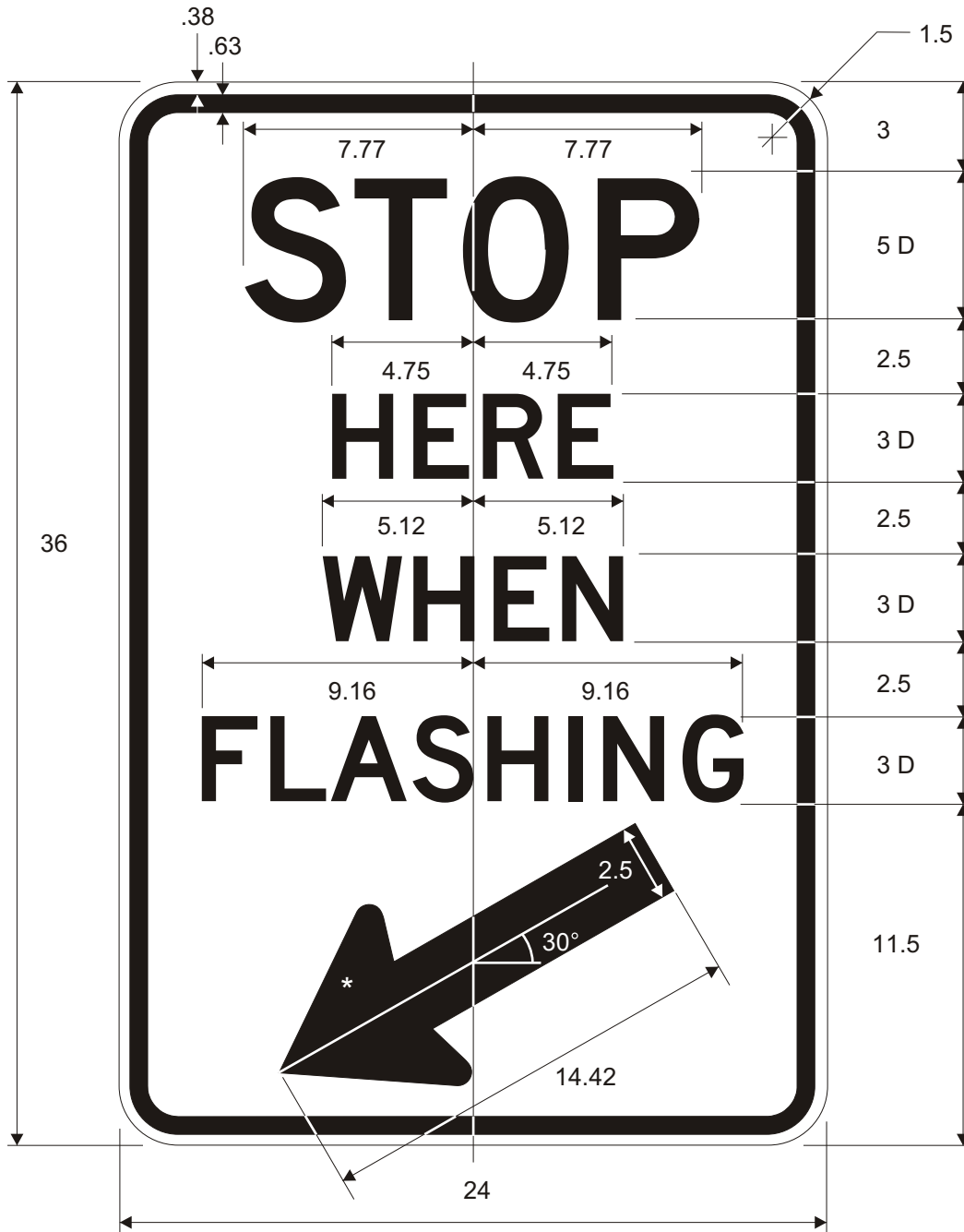

Border, Symbol and Legend: Red
 Background: White

*See Appendix B-1 for Standard Arrow Details.

R8-100



Border and Legend: Red
Background: White

Road Class	Dimensions (inches)											
	A	B	C	D	E	F	G	H	J	K	L	M
Conv & Min	30	36	0.38	0.63	4.6	7D	2.75	6D	4C	2.25	2.65	1.5



Border and Legend: Green
Background: White

Road Class	Dimensions (inches)							
	A	B	C	D	E	F	G	H
Conv & Min	18	24	0.38	0.63	4C	4B	3	1.5



Border and Legend: Black
Background: White

Road Class	Dimensions (inches)										
	A	B	C	D	E	F	G	H	J	K	L
Conv & Min	18	24	0.38	0.63	3	4D	2.50	3D	2D	2	1.50

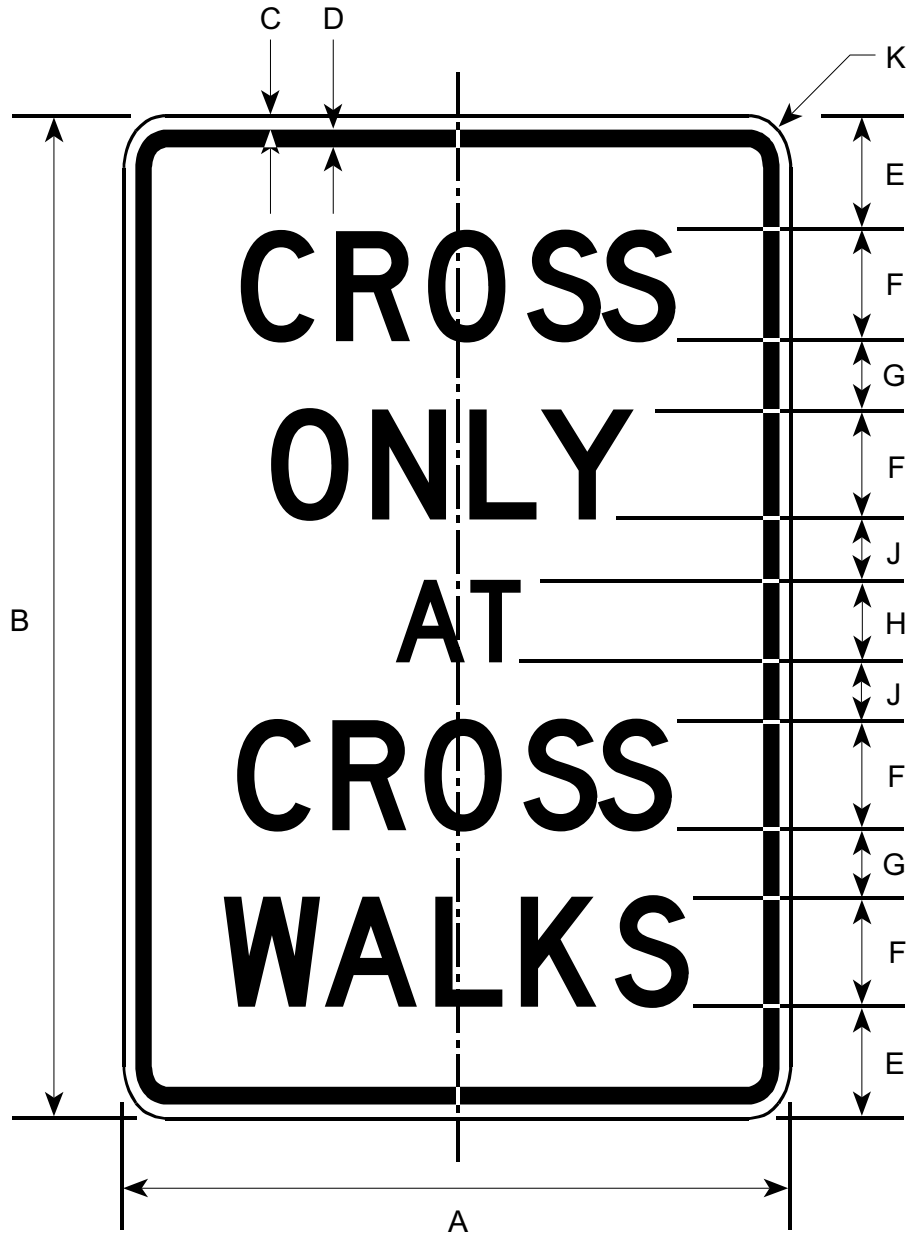

Border and Legend: Black
Background: White

Road Class	Dimensions (inches)									
	A	B	C	D	E	F	G	H	J	K
Conv & Min	12	18	0.38	0.38	2	2D	1.25	1.5D	1	1.5

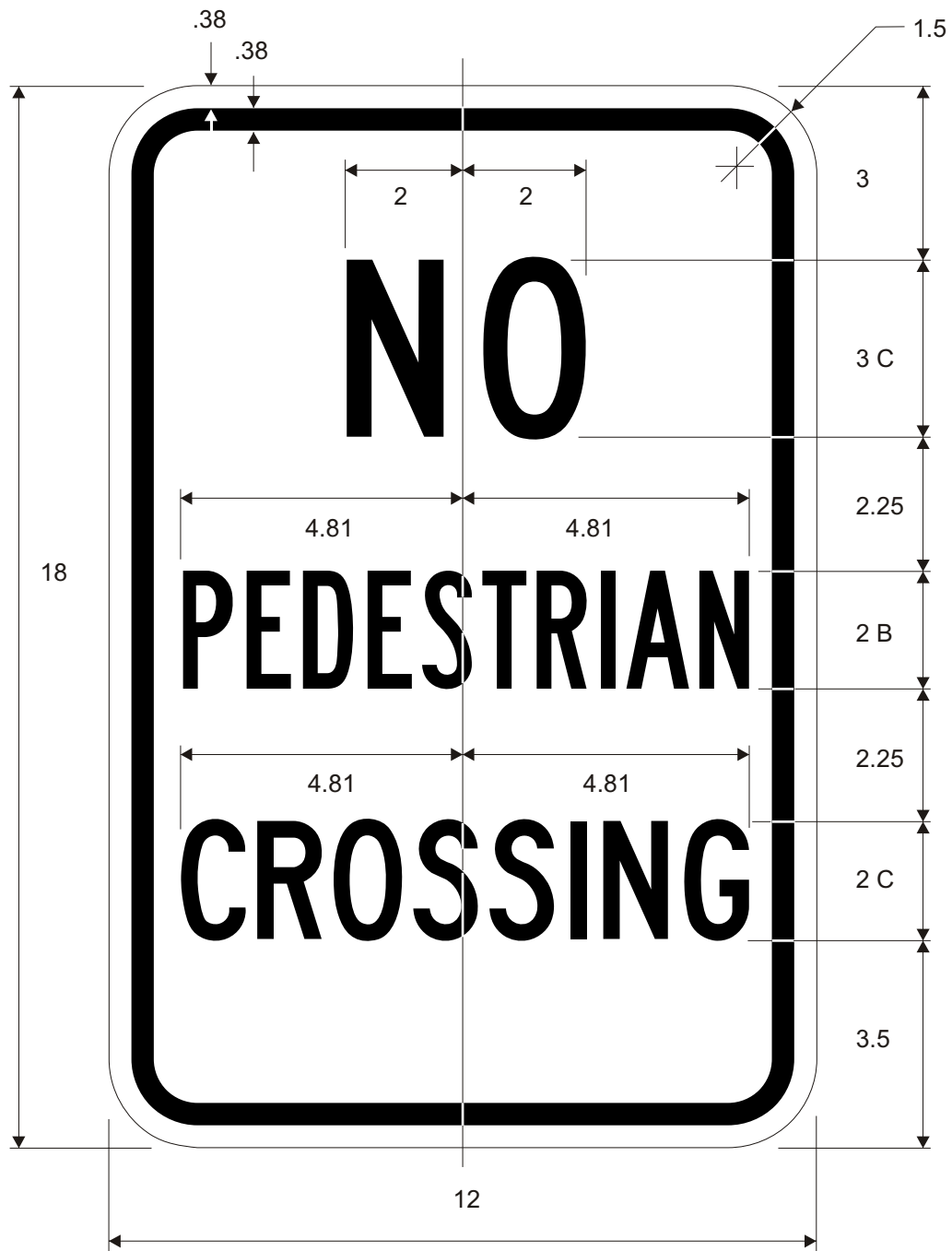

Border and Legend: Black
 Background: White

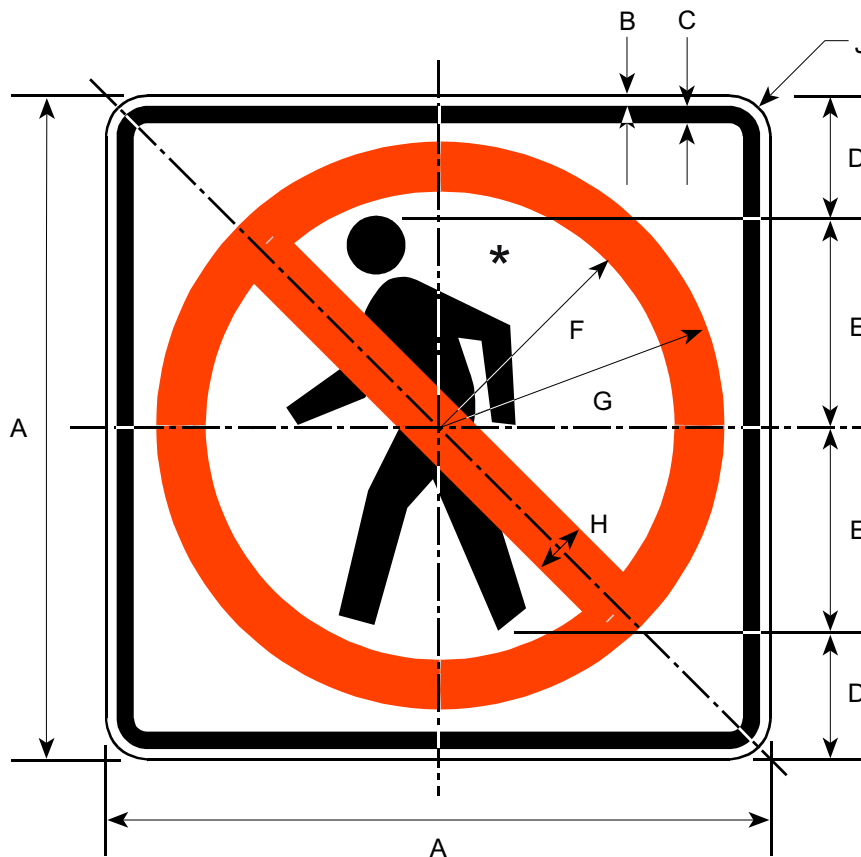

Border and Man: Black
 Circle and Diagonal: Red
 Background: White

* Make symbol proportional to the one shown.

Road Class	Dimensions (inches)								
	A	B	C	D	E	F	G	H	J
Conv & Min	18	0.38	0.63	3.50	5.50	6.38	7.63	1.5	1.5
Expressway	24	0.38	0.63	4.50	7.50	8.50	10.50	2.0	2.0
Freeway	30	0.50	0.75	5.75	9.25	10.63	13.13	2.5	2.5

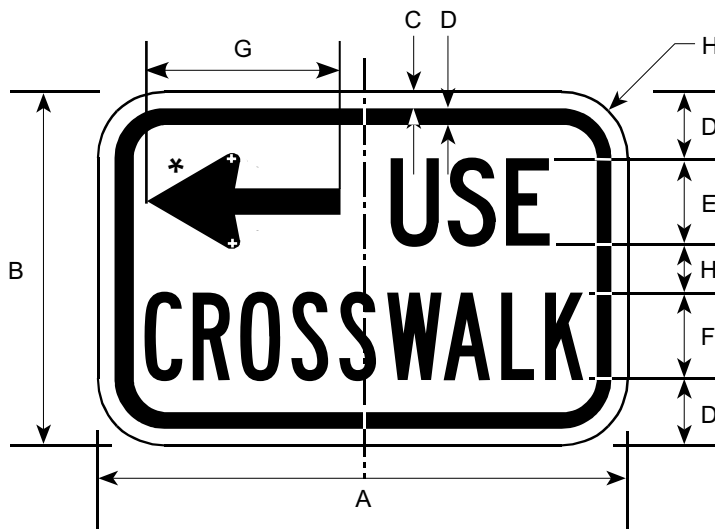

R9-3BL

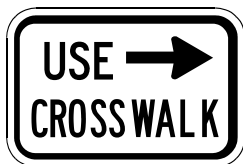

R9-3BR

Border and Legend: Black
Background: White

*See Appendix B-1 for Standard Arrow Details.

Road Class	Dimensions (inches)							
	A	B	C	D	E	F	G	H
Conv & Min	18	12	0.38	2.25	3C	3B	6.0	1.5

R9-3C

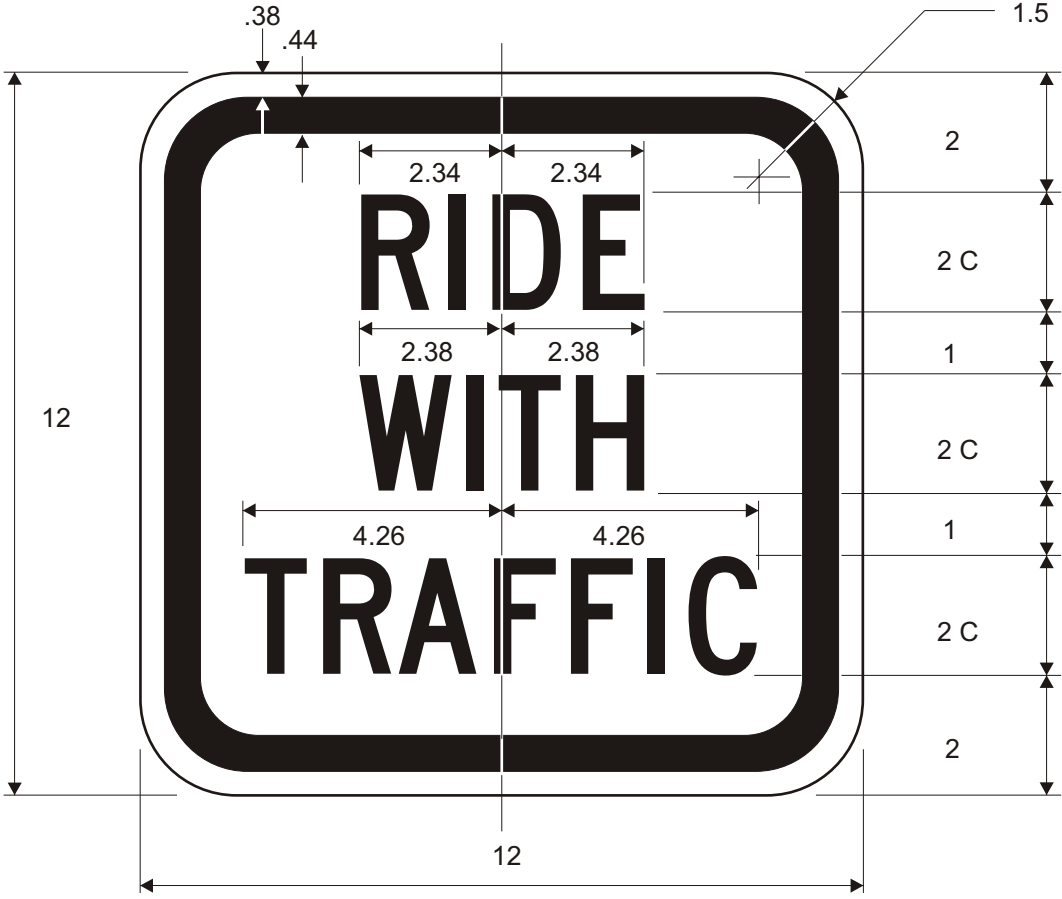

Border and Legend: Black
Background: White



Border and Legend: Black
Background: White

Road Class	Dimensions (inches)								
	A	B	C	D	E	F	G	H	J
Conv & Min	18	24	0.38	0.63	3	6C	2	4C	1.5

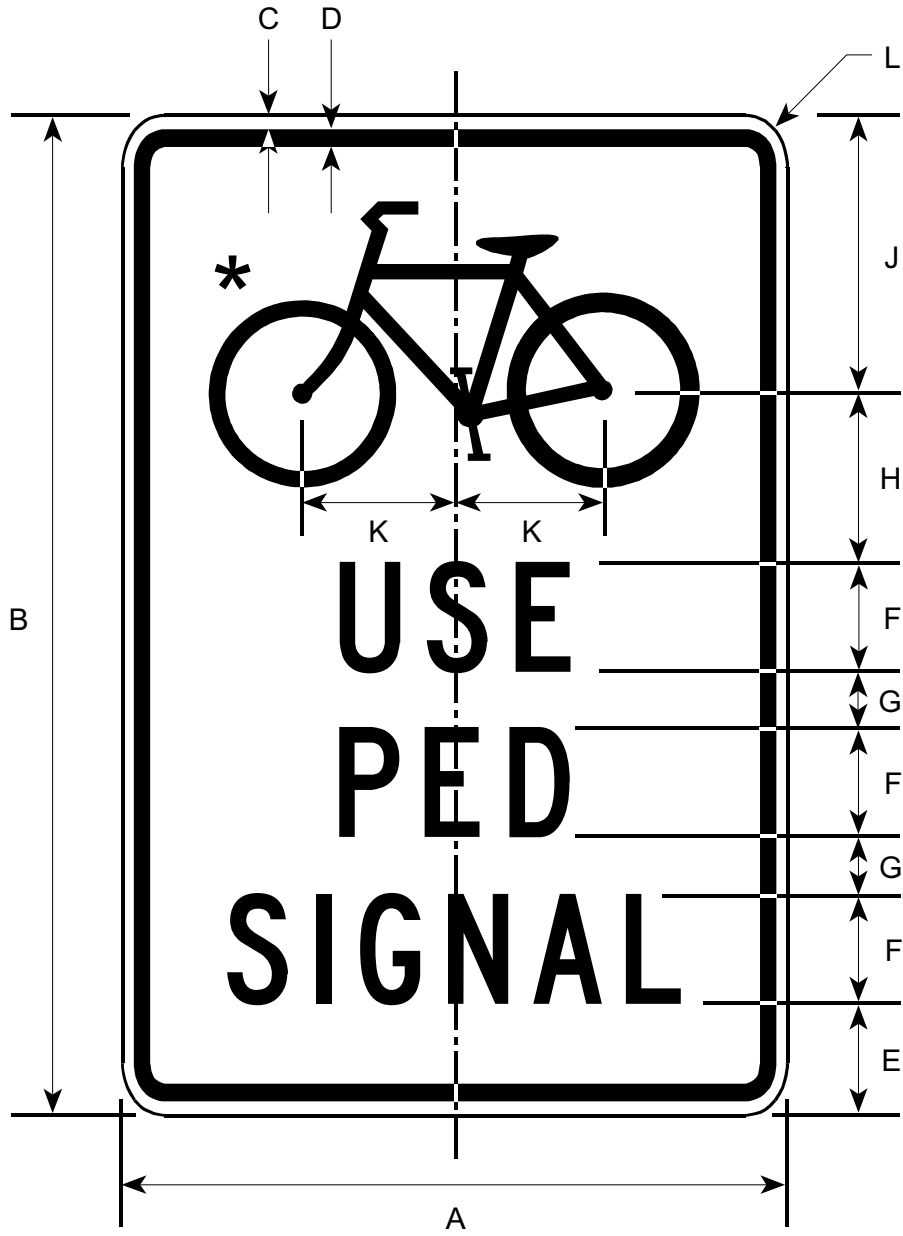

Border and Legend: Black
Background: White

* Make symbol proportional to the one shown.

Road Class	Dimensions (inches)										
	A	B	C	D	E	F	G	H	J	K	L
Conv & Min	12	18	0.38	0.38	2	2C	1	3	5	2.75	1.5

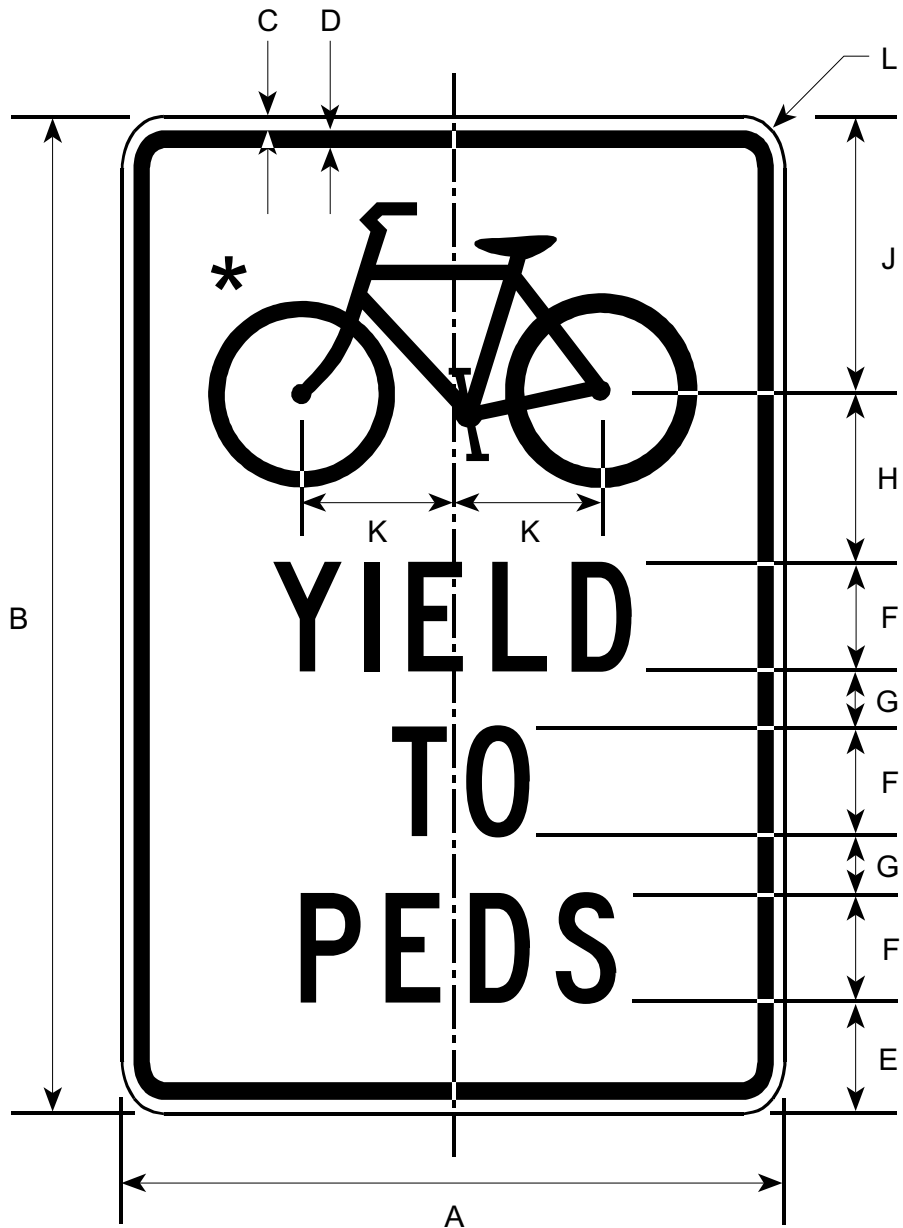

Border and Legend: Black
Background: White

* Make symbol proportional
to the one shown.

Road Class	Dimensions (inches)										
	A	B	C	D	E	F	G	H	J	K	L
Conv & Min	12	18	0.38	0.38	2	2C	1	3	5	2.75	1.5

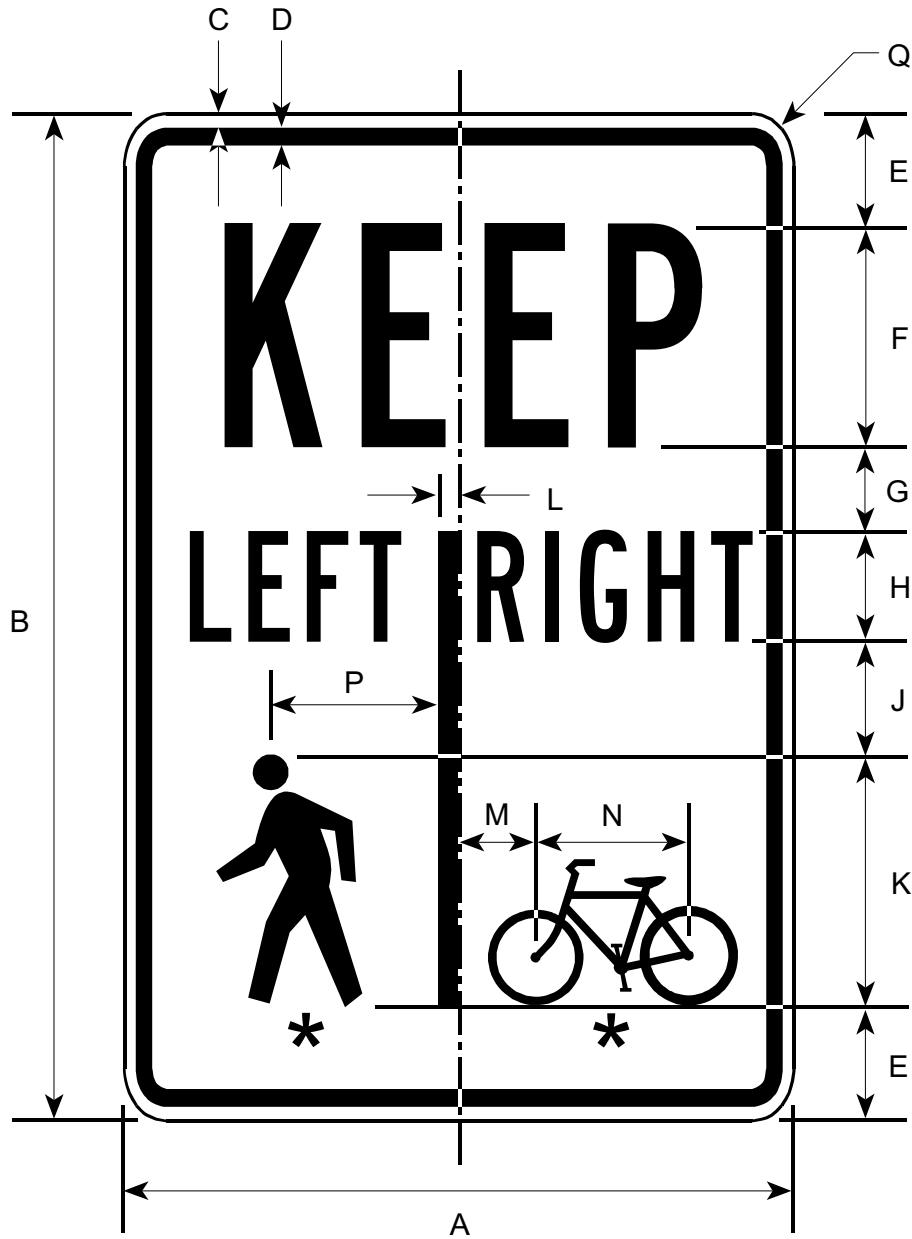

Border and Legend: Black
Background: White

* Make symbol proportional
to the one shown.

Road Class	Dimensions (inches)															
	A	B	C	D	E	F	G	H	J	K	L	M	N	P	Q	
Conv & Min	12	18	0.38	0.38	2	4B	1.5	2B	2	4.5	0.38	1.25	2.75	3.25	1.5	

R9-8

R9-9

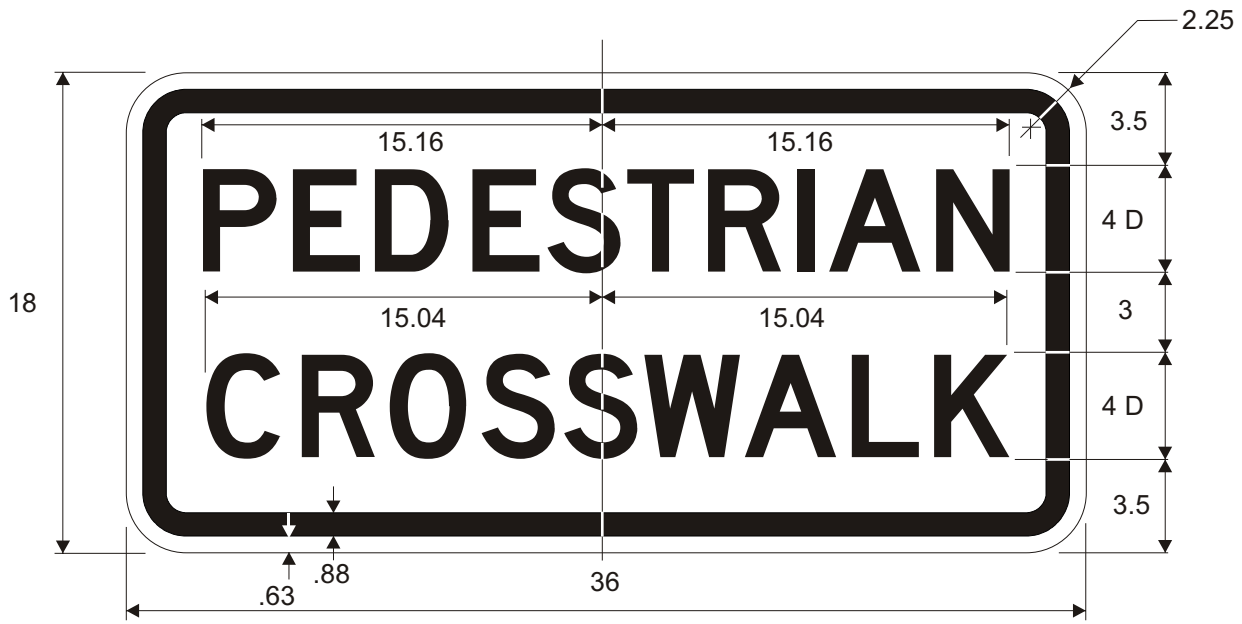

R9-8

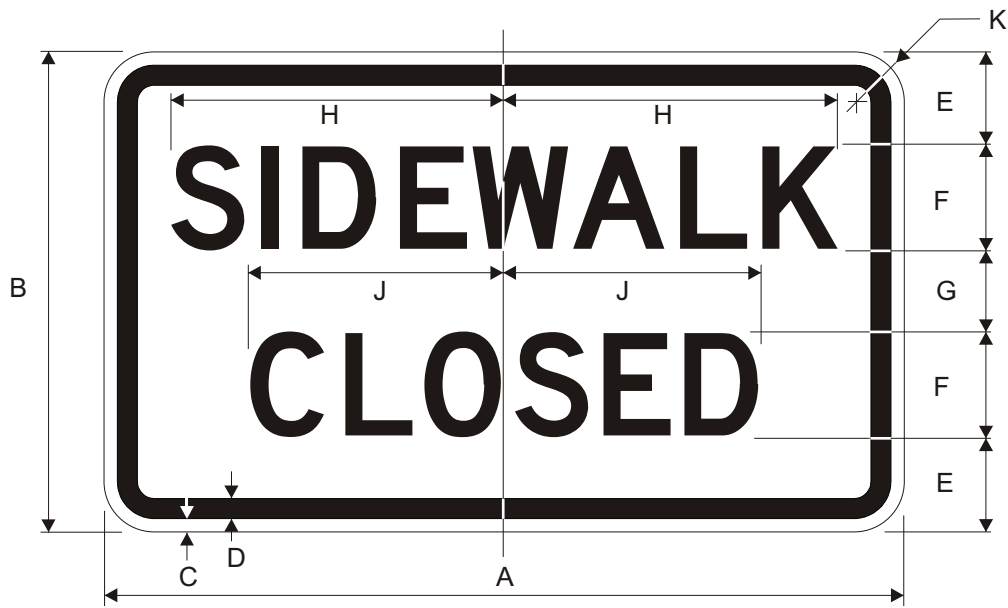

R9-9

Border and Legend: Black
Background: White

Road Class	Dimensions (inches)									
	A	B	C	D	E	F	G	H	J	K
Min.	24	12	0.38	0.63	2.13	3D*	1.75	9.37	7.23	1.5
Conv.	30	18	0.63	0.88	3.5	4D*	3.0	12.49	9.62	2.25

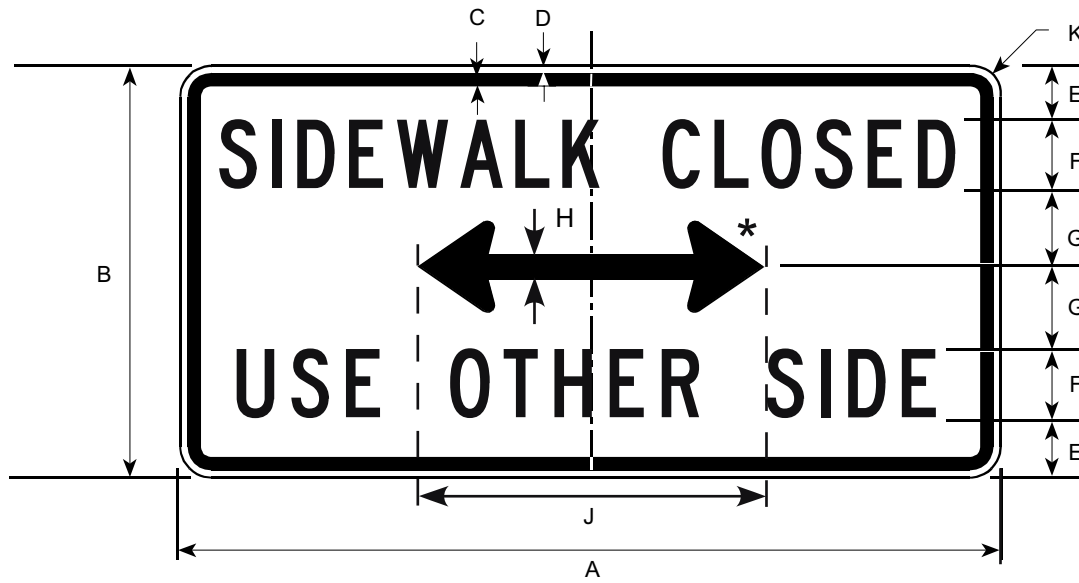

Border and Legend: Black
Background: White

*See Appendix B-1 for Standard Arrow Details.

Road Class	Dimensions (inches)									
	A	B	C	D	E	F	G	H	J	K
Conv & Min	24	12	0.63	0.38	1.5	2C	2.5	1.3	12	1.5

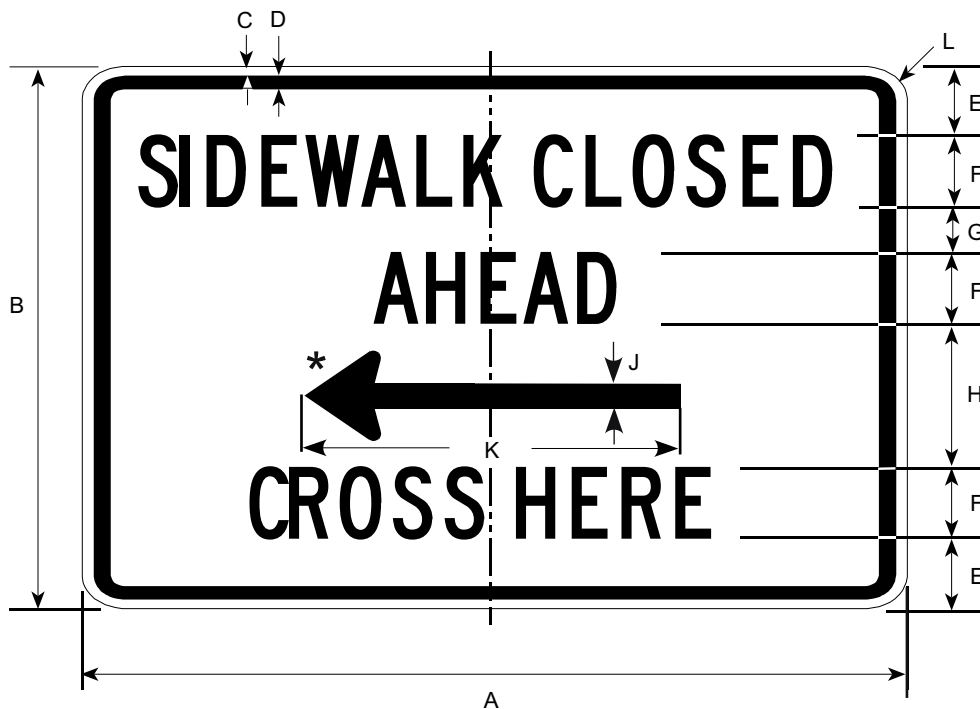

Border and Legend: Black
 Background: White

*See Appendix B-1 for Standard Arrow Details.

Road Class	Dimensions (inches)										
	A	B	C	D	E	F	G	H	J	K	L
Conv & Min	36	24	0.38	0.63	3.0	3C	2.0	7.0	1.3	12	1.5

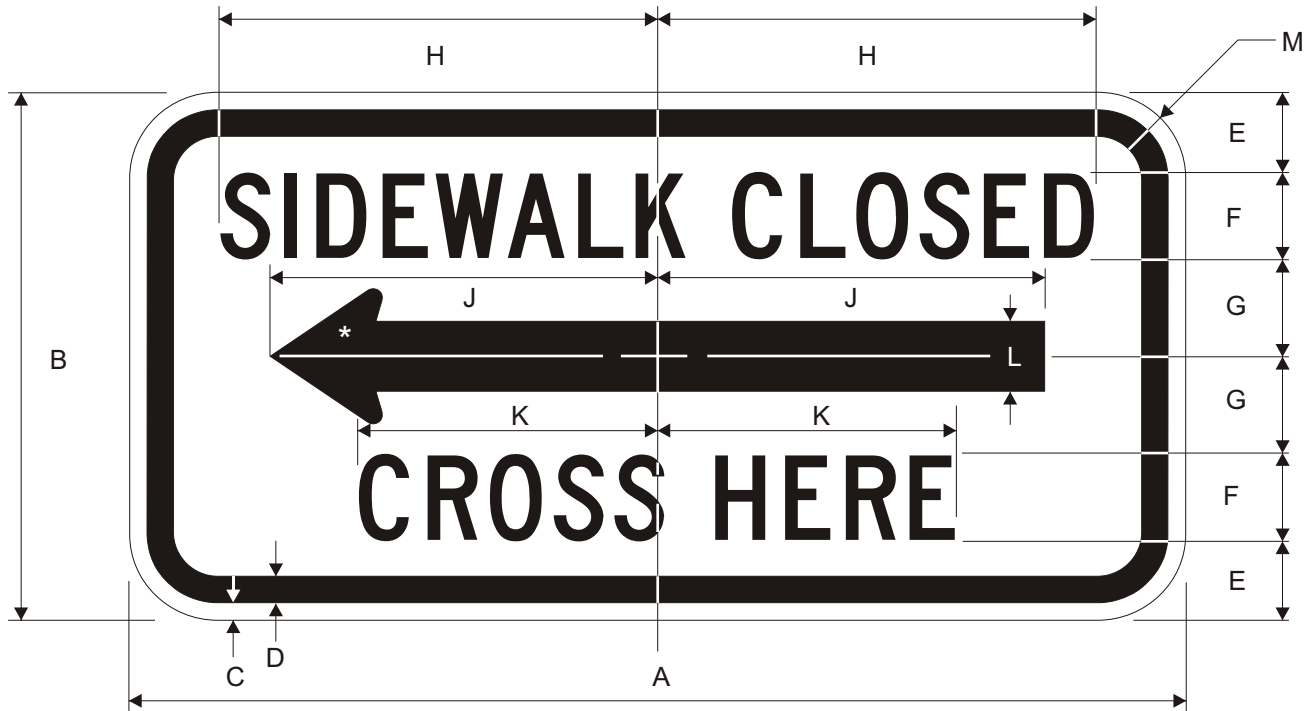

Border and Legend: Black
Background: White

*See Appendix B-1 for Standard Arrow Details.

Road Class	Dimensions (inches)											
	A	B	C	D	E	F	G	H	J	K	L	M
Conv/Min	24	12	0.38	0.63	1.75	2C	2.25	9.97	8.75	7.79	1.6	1.5

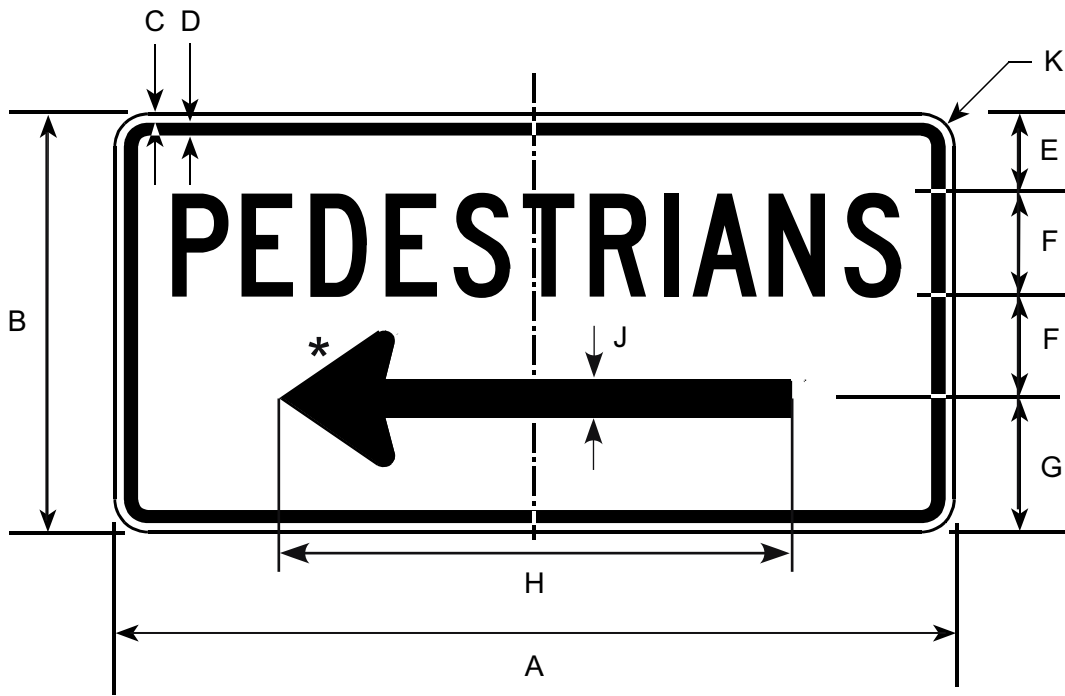

Border and Legend: Black
Background: White

*See Appendix B-1 for Standard Arrow Details.

Road Class	Dimensions (inches)									
	A	B	C	D	E	F	G	H	J	K
Conv & Min	24	12	0.38	0.63	3	3C	3	13.5	1.3	1.5



Border and Legend: Black
 Background: White

* Make Symbols proportional to sign drawing.

Road Class	Dimensions (inches)									
	A	B	C	D	E	F	G	H	J	
Conv & Min	24	24	0.38	0.63	4	3D	8	5	1.5	

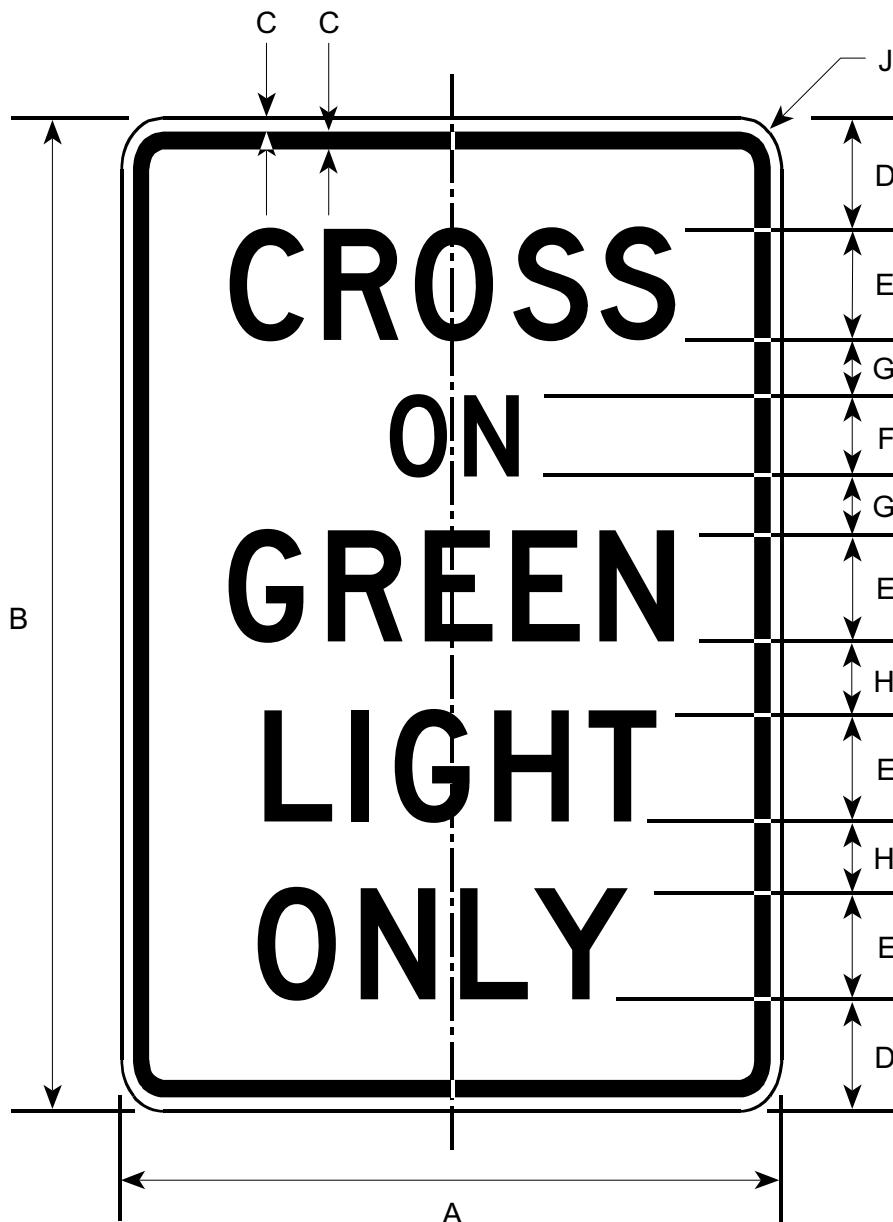

Border and Legend: Black
Background: White

Road Class	Dimensions (inches)								
	A	B	C	D	E	F	G	H	J
Conv & Min	12	18	0.38	2	2D	1.5D	1	1.25	1.5

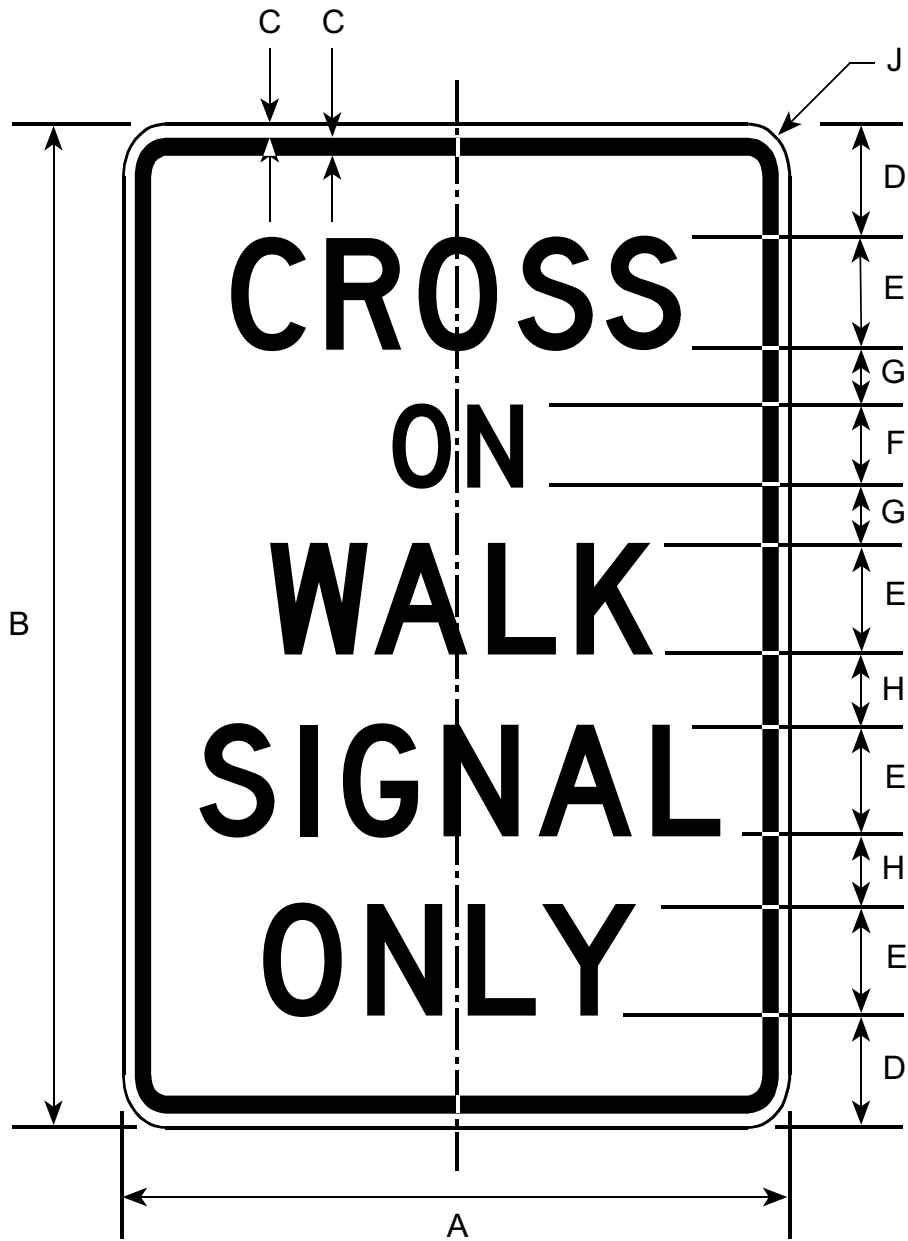

Border and Legend: Black
Background: White

Road Class	Dimensions (inches)								
	A	B	C	D	E	F	G	H	J
Conv & Min	12	18	0.38	2	2D	1.5D	1	1.25	1.5

R10-2A

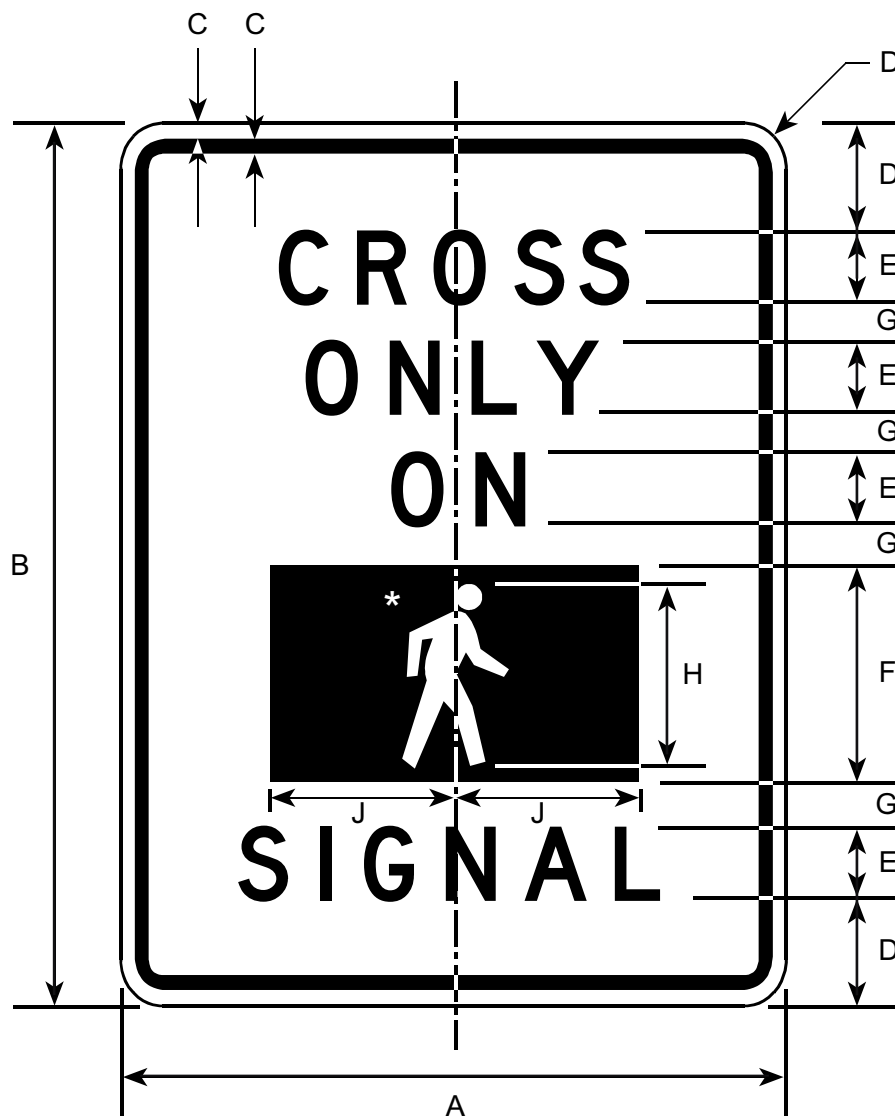

Border and Legend: Black
Background: White

* Make symbol proportional
to the one shown.

Road Class	Dimensions (inches)								
	A	B	C	D	E	F	G	H	J
Conv & Min	9	12	0.38	1.5	1D	3	0.5	2.5	2

R10-3A

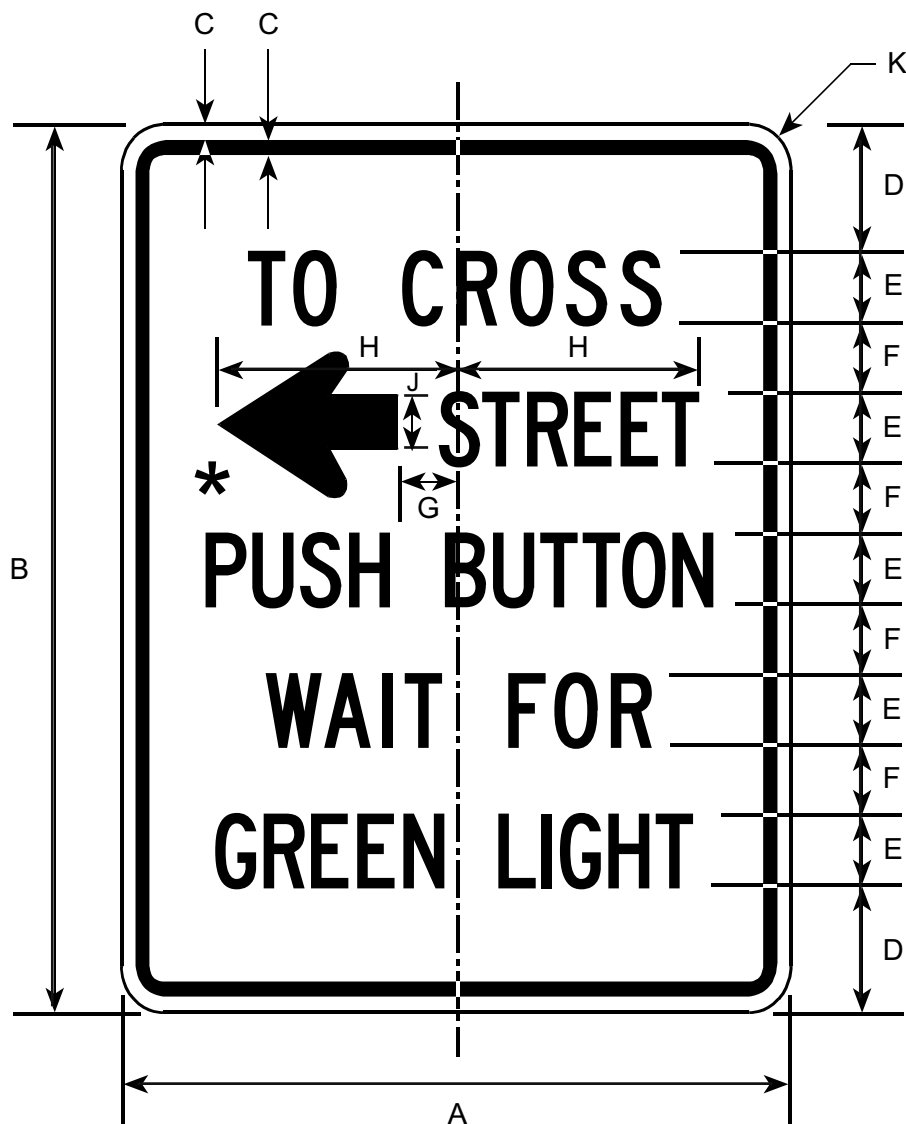

Border and Legend: Black
Background: White

*See Appendix B-1 for Standard Arrow Details.

Road Class	Dimensions (inches)									
	A	B	C	D	E	F	G	H	J	K
Conv & Min	9	12	0.38	1.5	1C	1.0	0.5	3.25	0.75	1.5

R10-3B

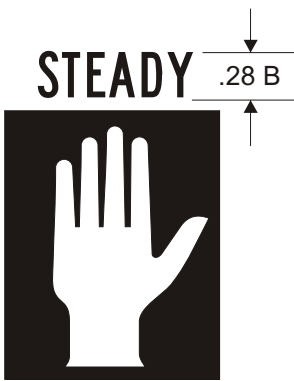
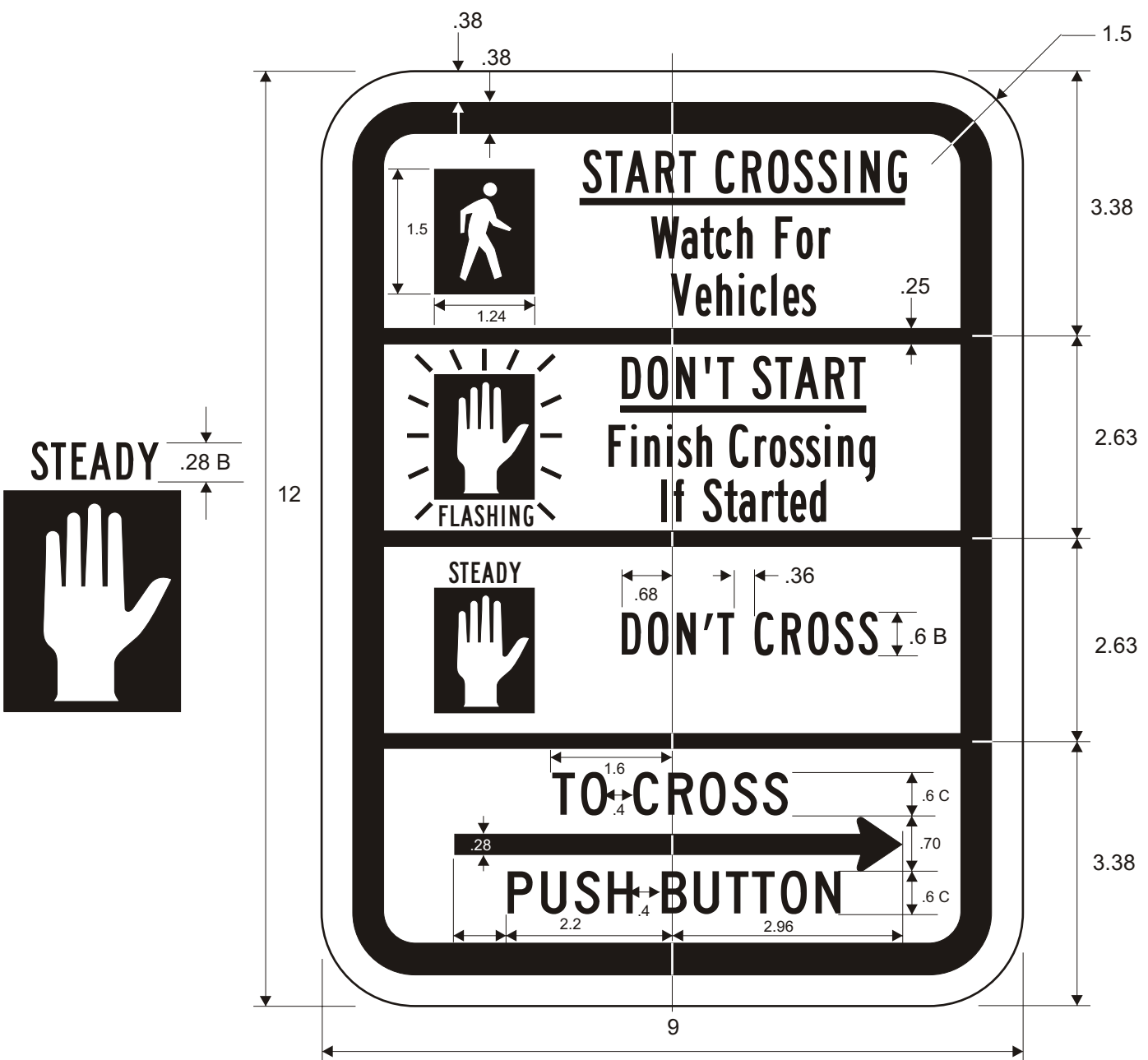

Legend and Border: Black
 Background: White
 Hand Symbol: Orange

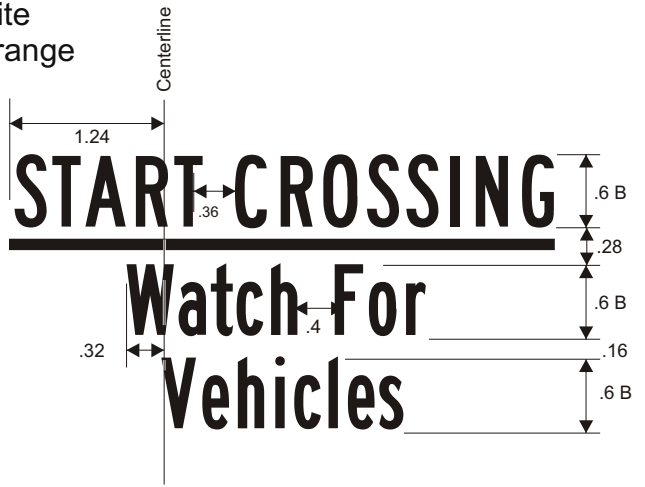

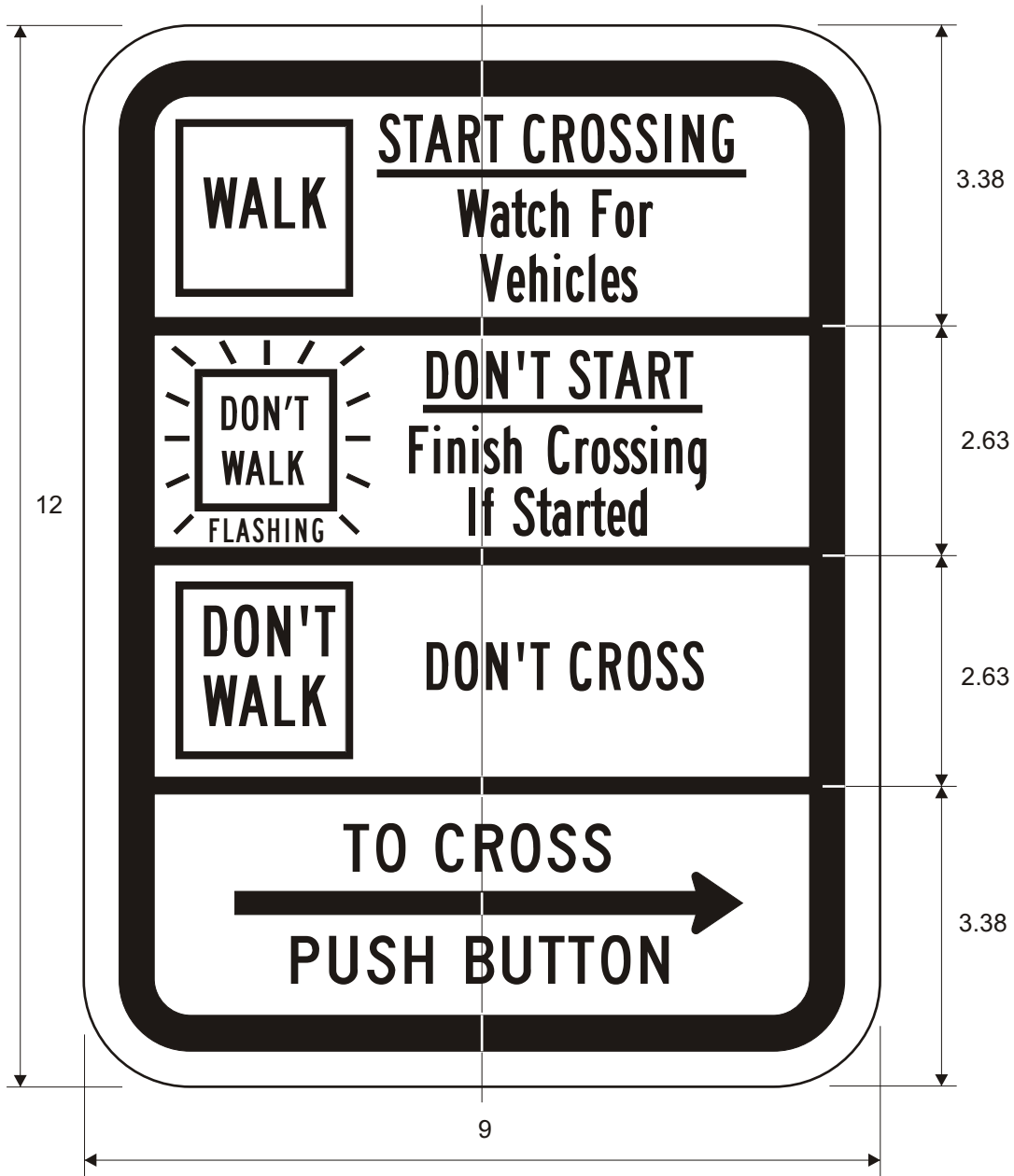

Border and Legend: Black
Background: White
Don't Walk: Orange

R10-3D

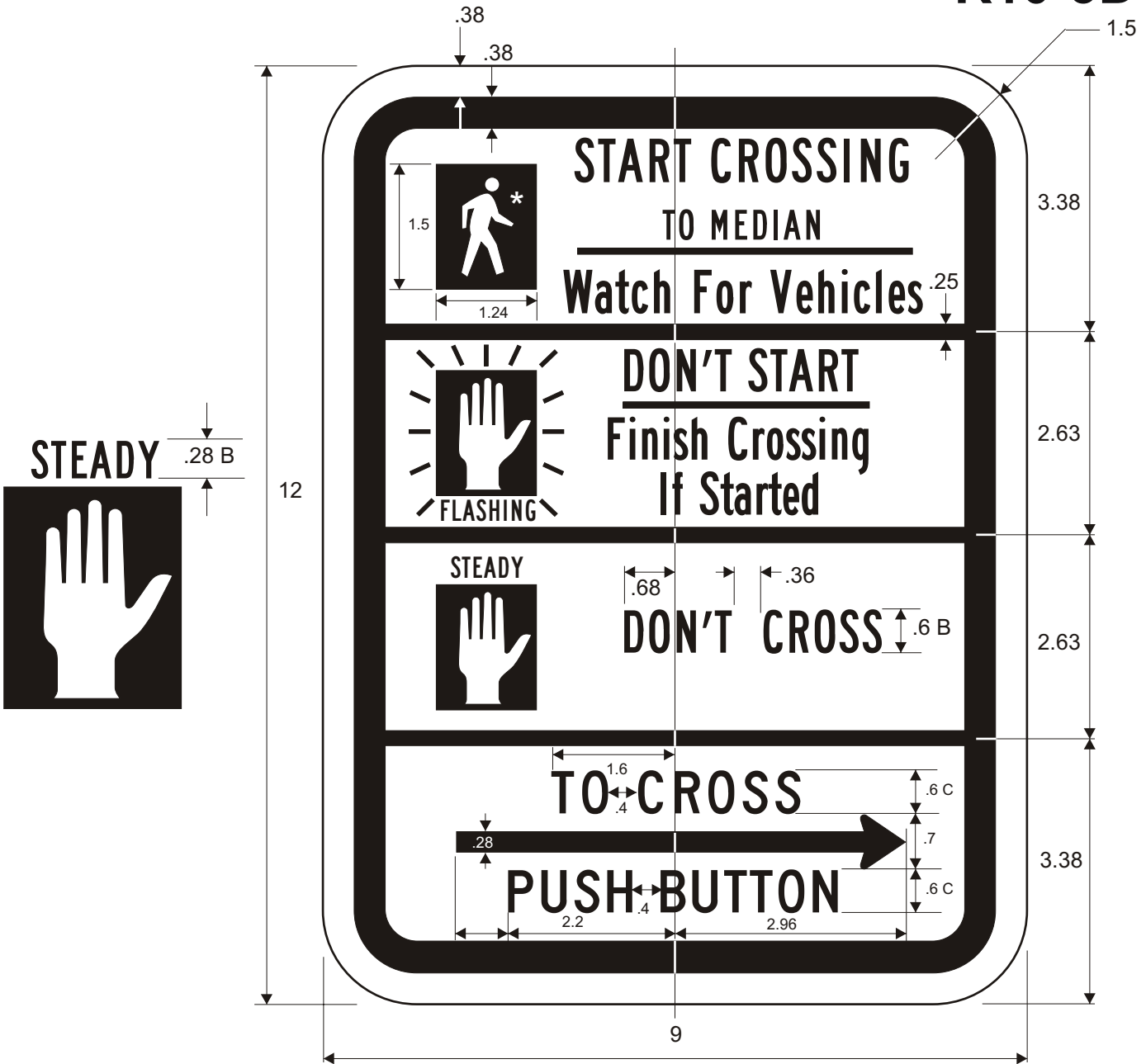

Legend and Border: Black
 Background: White
 Hand Symbol: Orange

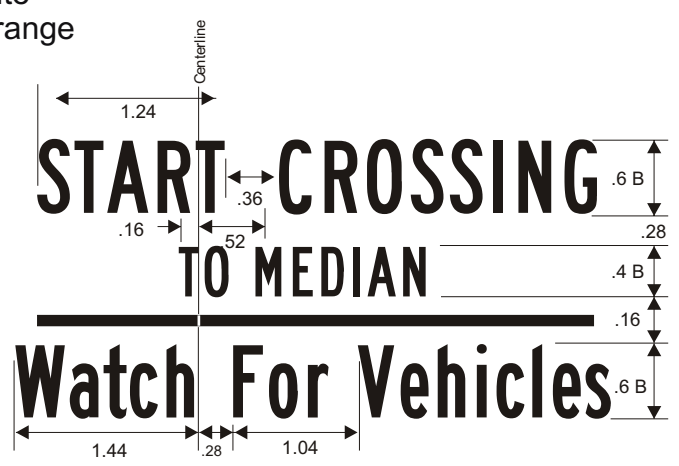
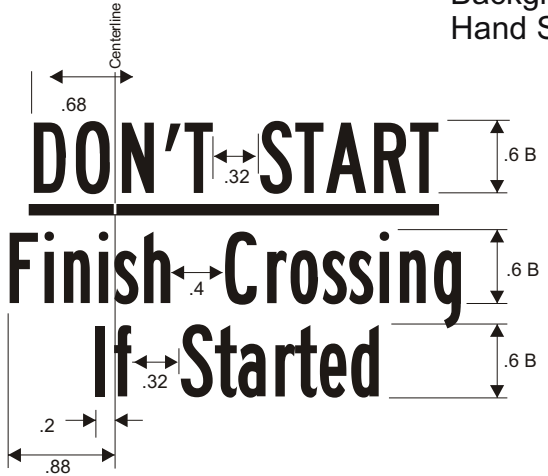

R10-3E

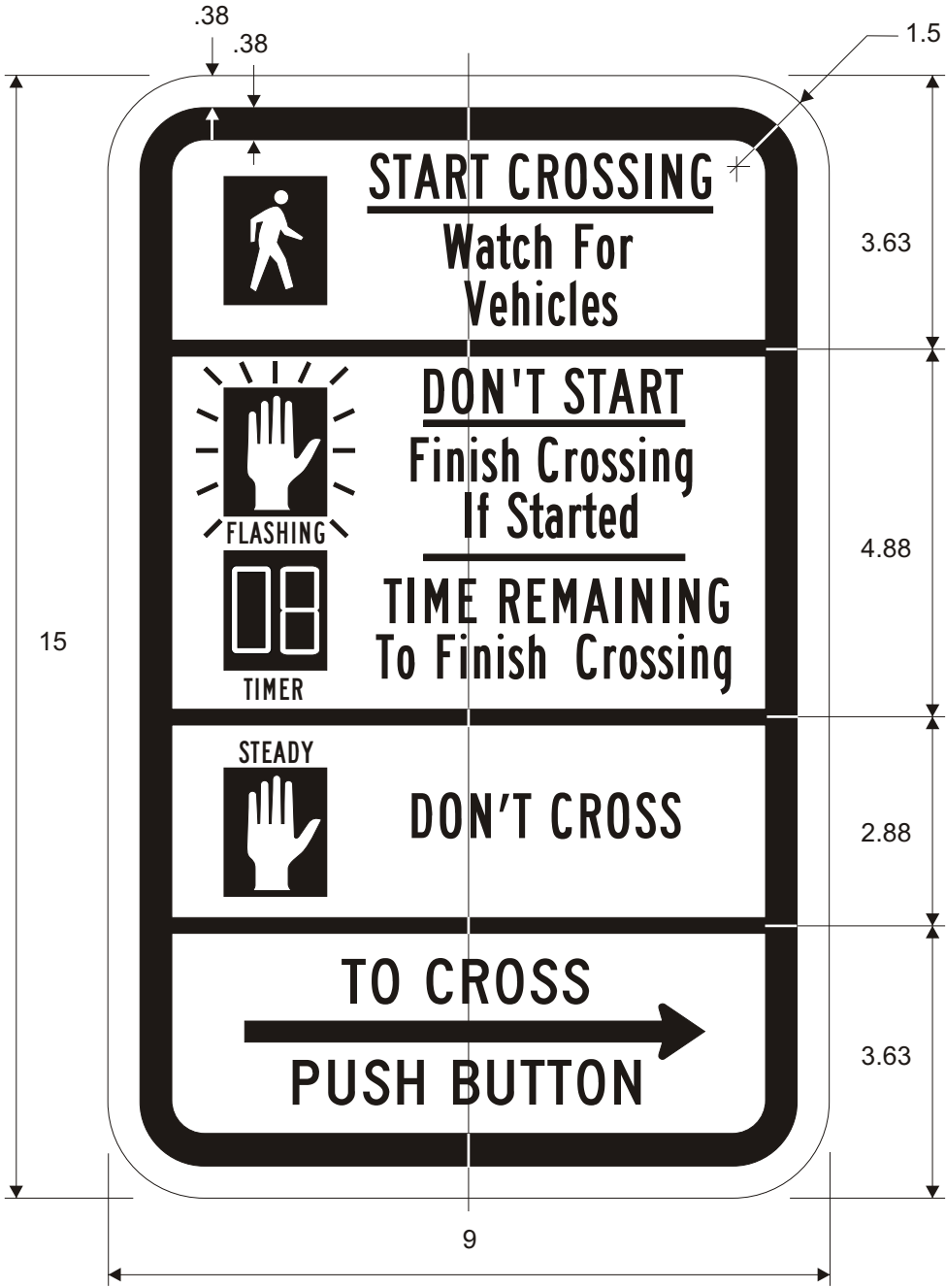

Legend and Border: Black
 Background: White
 08 and Hand Symbol: Orange

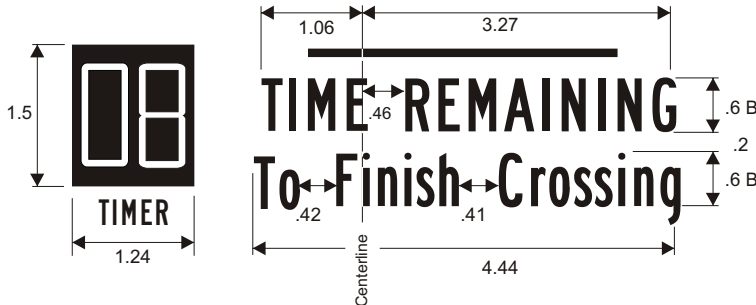

R10-4A

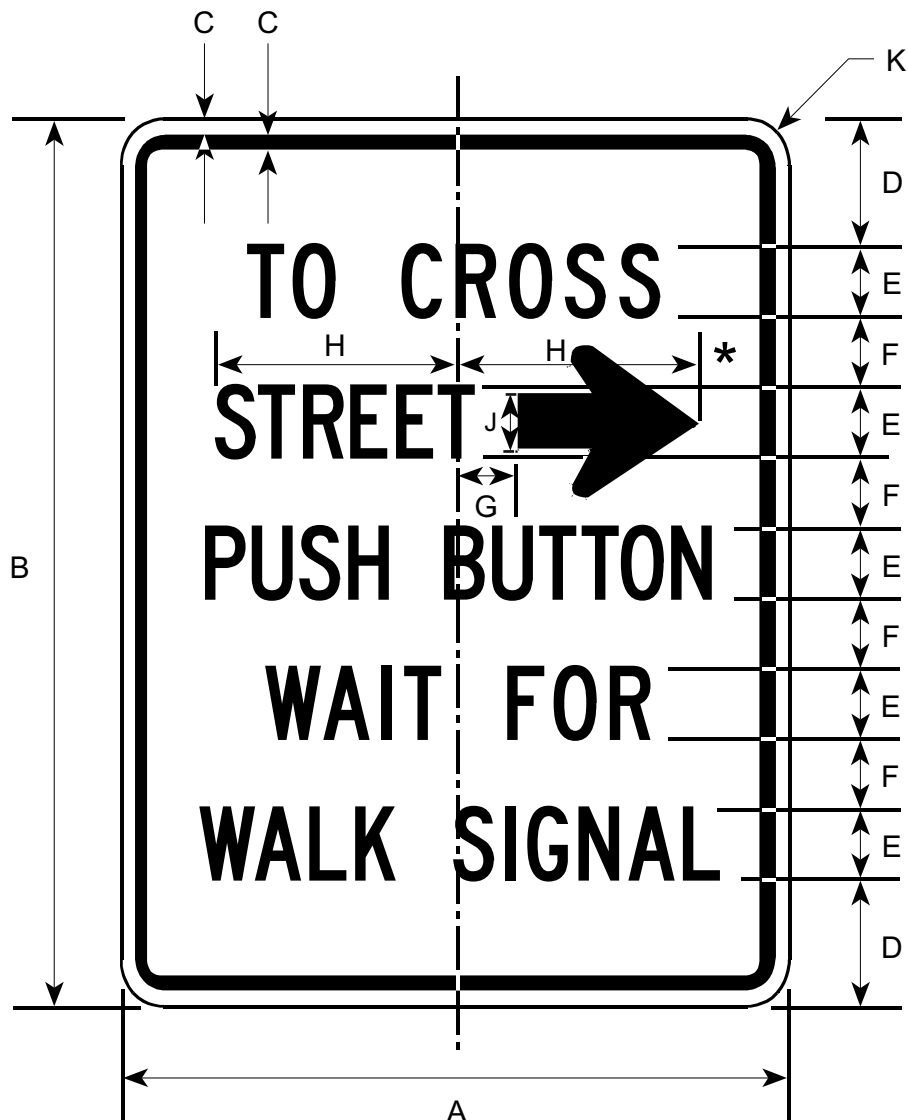

Border and Legend: Black
Background: White

*See Appendix B-1 for Standard Arrow Details.

Road Class	Dimensions (inches)									
	A	B	C	D	E	F	G	H	J	K
Conv & Min	9	12	0.38	1.5	1C	1.0	0.5	3.25	0.75	1.5

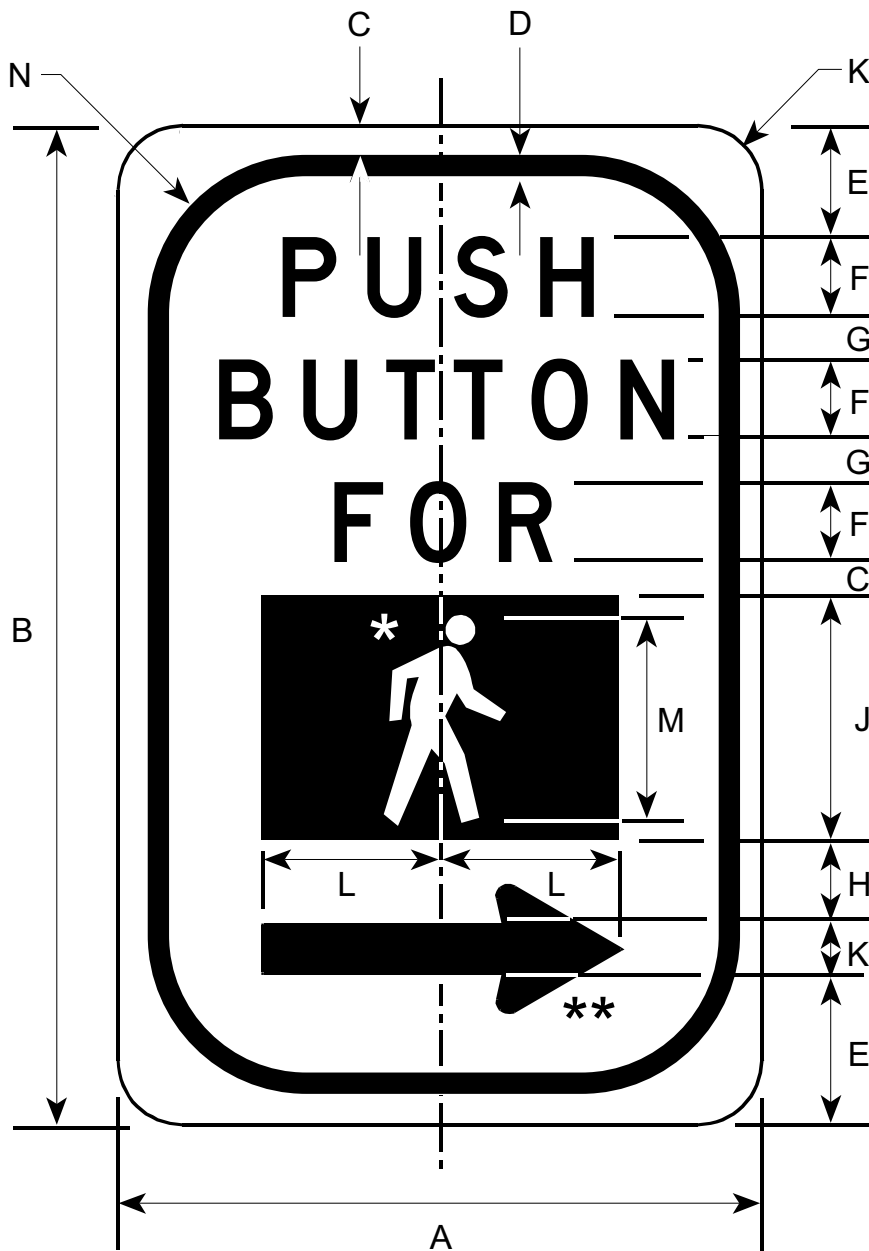

Border and Legend: Black
Background: White

Right side version shown. Reverse the arrow when the street is to the left.

* Make symbol proportional to the one shown.

** See Appendix B-1 for Standard Arrow Details.

Road Class	Dimensions (inches)												
	A	B	C	D	E	F	G	H	J	K	L	M	N
Conv & Min	5	8	0.25	0.88	1.13	0.63D	0.31	0.63	1.88	0.5	1.25	1.5	1



Border and Legend: Black
Background: White

Prior to the 2002 publication of this manual, this sign was numbered R10-5A.

Road Class	Dimensions (inches)								
	A	B	C	D	E	F	G	H	I
Minimum	18	24	0.38	0.63	3.00	3C	2.00	3D	1.50
Conventional	24	30	0.38	0.63	3.25	4C	2.50	4D	1.50
Expressway	30	36	0.50	0.75	4.25	5C	2.50	5D	1.88

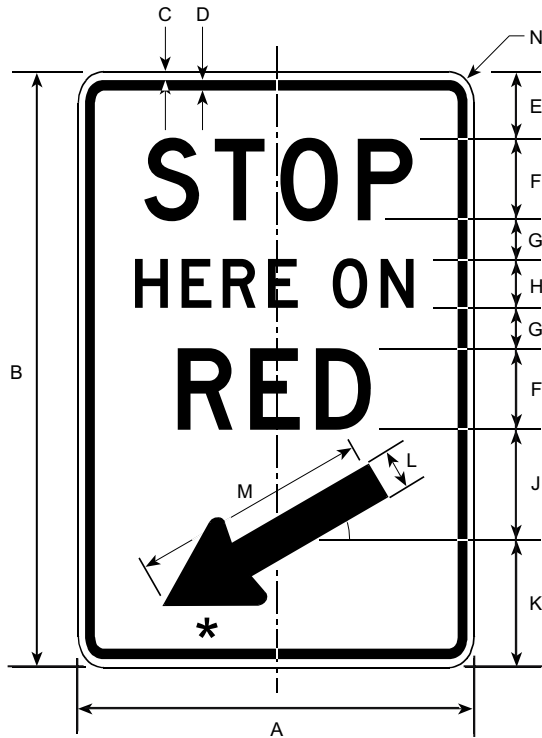

R10-6L

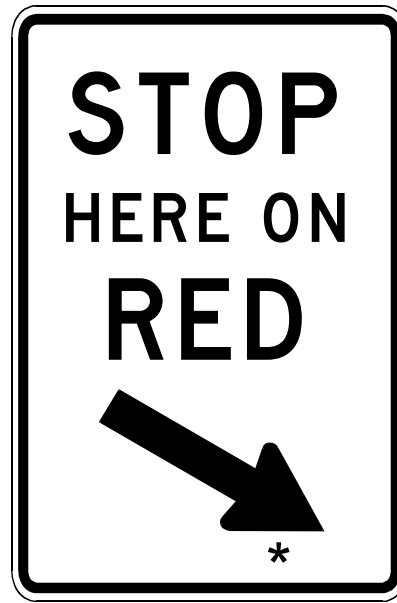

R10-6R

Border and Legend: Black
Background: White

*See Appendix B-1 for Standard Arrow Details.

Road Class	Dimensions (inches)												
	A	B	C	D	E	F	G	H	J	K	L	M	N
Conv & Min	24	36	0.38	0.63	4	5D	2.5	3D	6.5	7.5	2.63	14.63	1.5

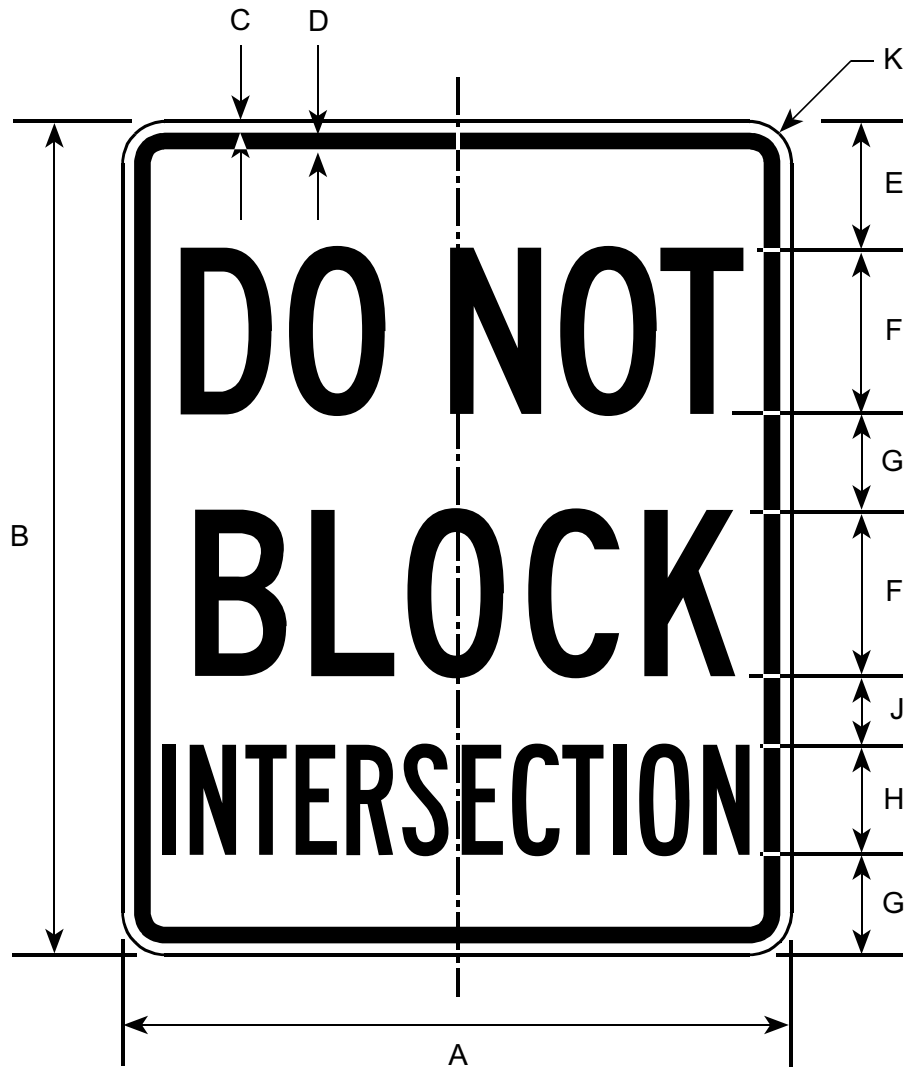

Border and Legend: Black
Background: White

Road Class	Dimensions (inches)									
	A	B	C	D	E	F	G	H	J	K
Conv & Min	24	30	0.38	0.63	4.5	6C	3.5	4B	2.5	1.5

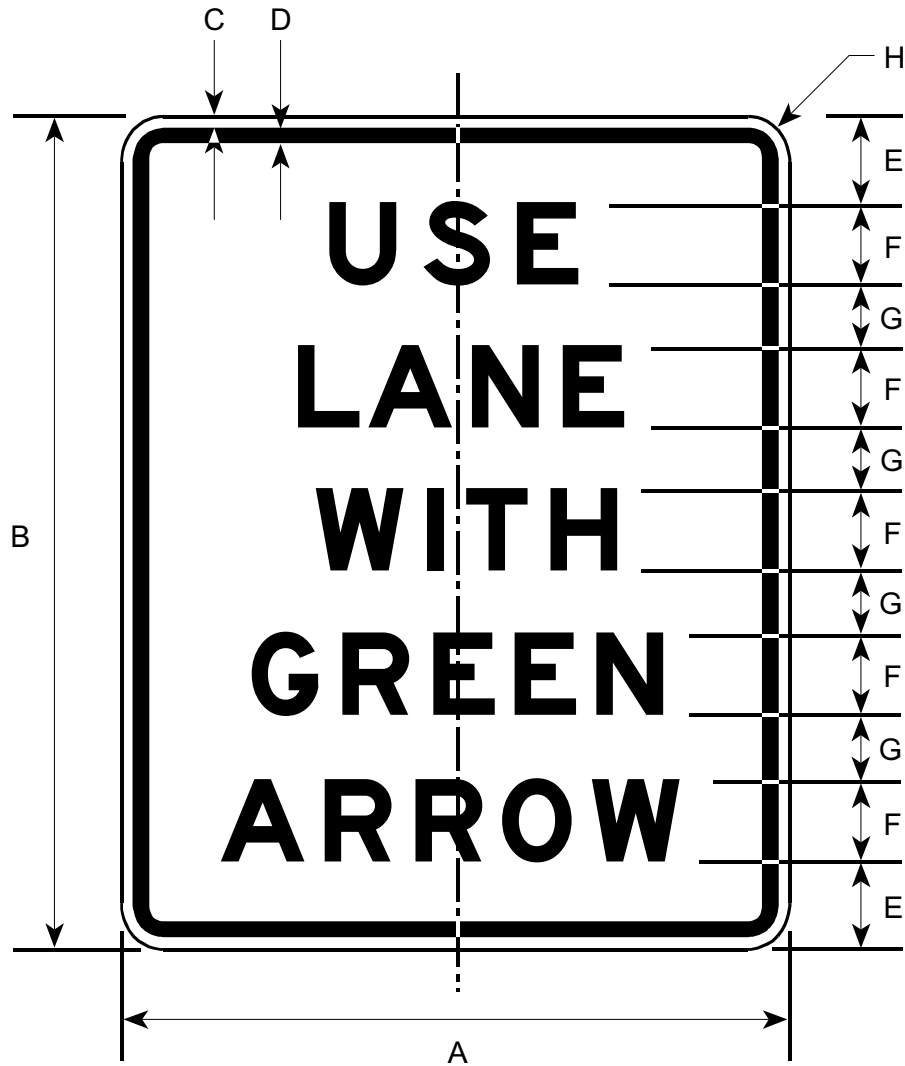

Border and Legend: Black
Background: White

Road Class	Dimensions (inches)							
	A	B	C	D	E	F	G	H
Minimum	18	24	0.38	0.63	3	2E	2.00	1.50
Conventional	24	30	0.38	0.63	3	3E	2.25	1.50
Expressway	30	36	0.50	0.75	3	4E	2.50	1.88

R10-10

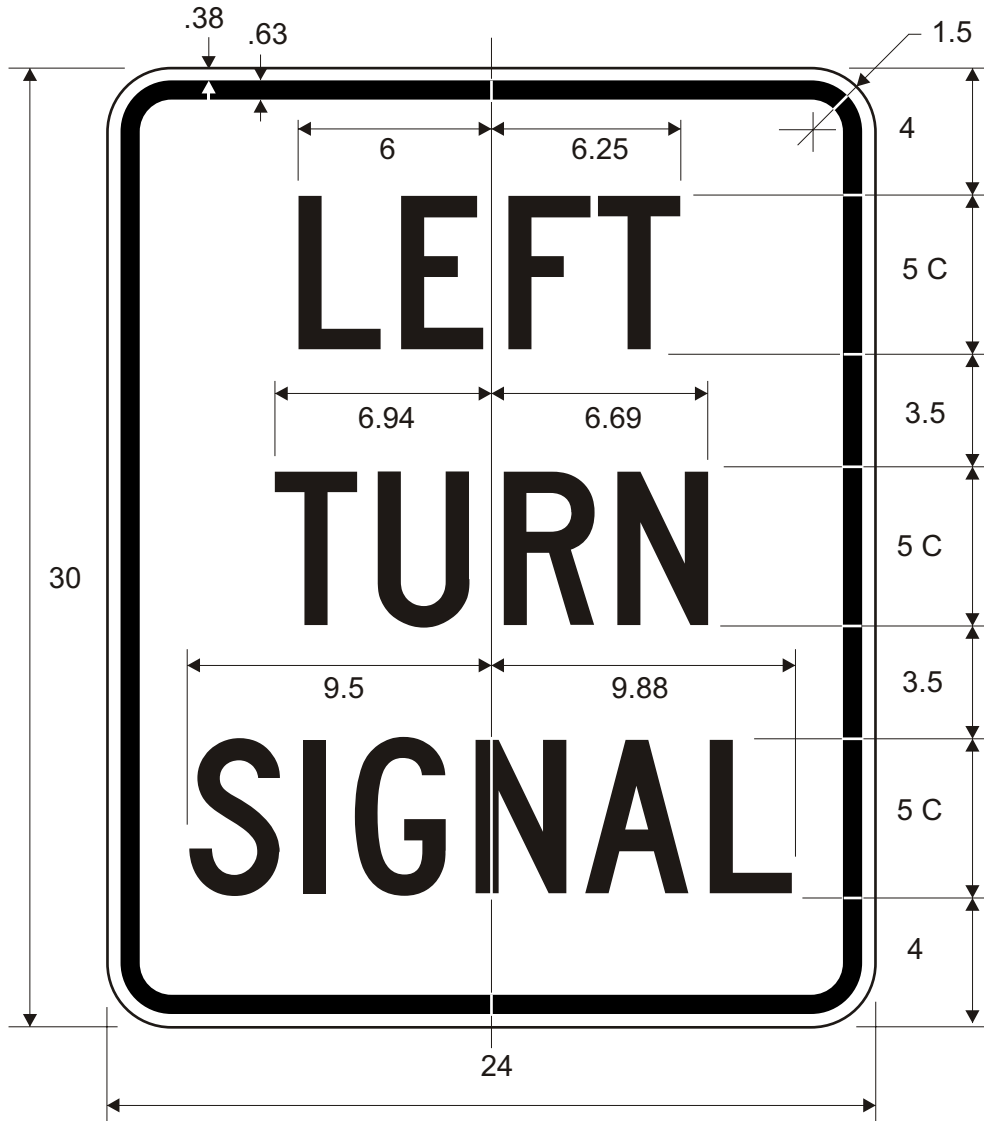

R10-10L



R10-10R



Legend and Border: Black
Background: White

R10-11A

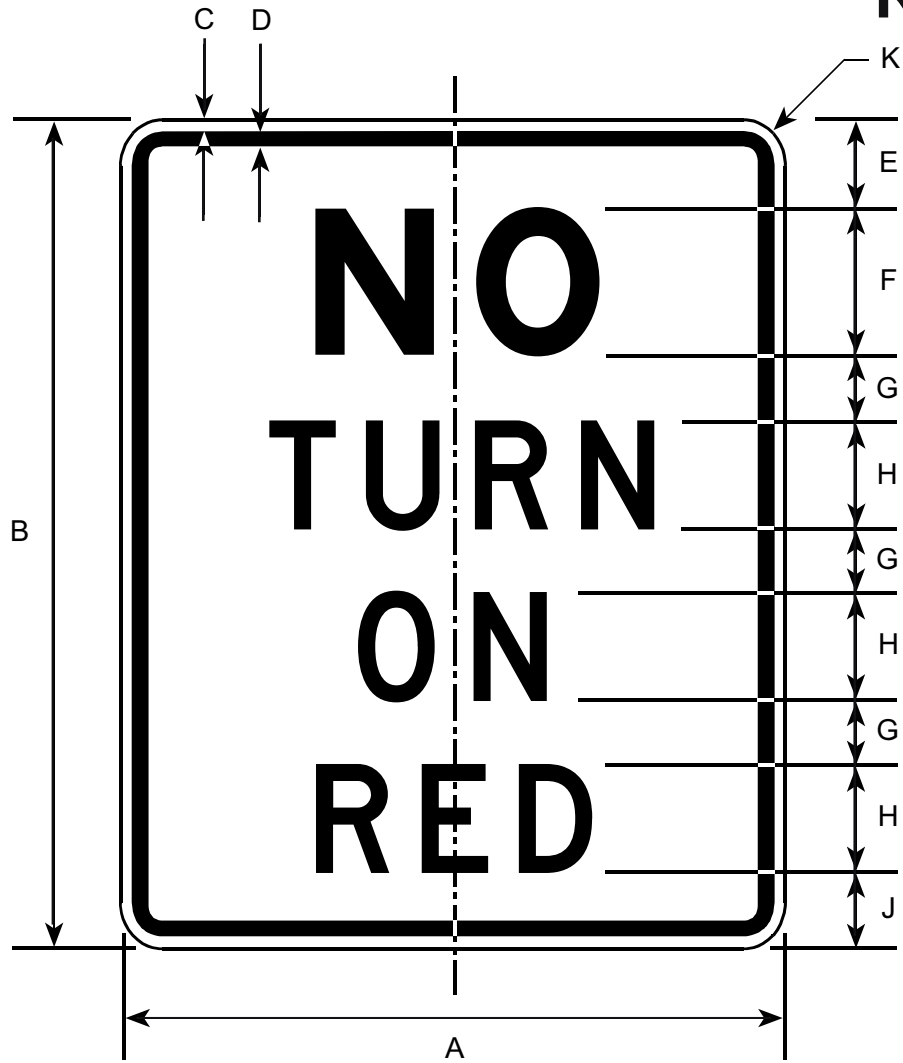

Border and Legend: Black
Background: White

Road Class	Dimensions (inches)									
	A	B	C	D	E	F	G	H	J	K
Minimum	18	24	0.38	0.63	3	4E	1.75	3D	2.75	1.50
Conventional	24	30	0.38	0.63	3	5E	2.25	4D	3.00	1.50
Oversized	36	48	0.63	0.88	6	8E	3.50	6D	5.50	2.25

R10-11B

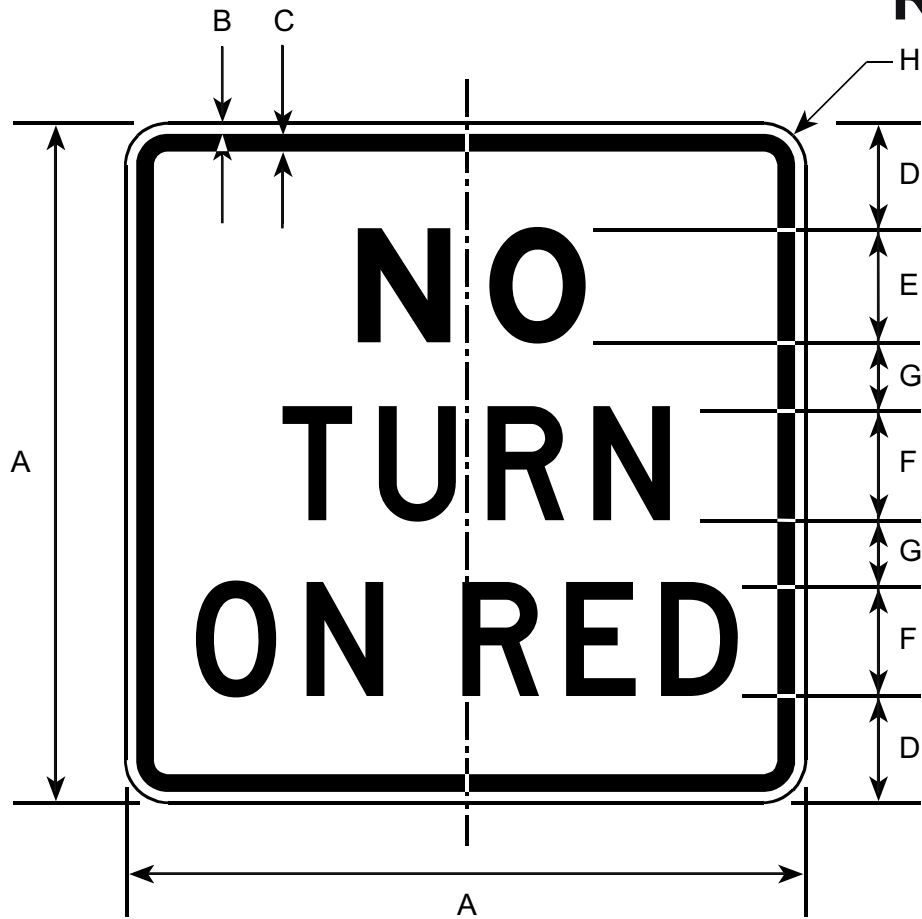

Border and Legend: Black
Background: White

Road Class	Dimensions (inches)							
	A	B	C	D	E	F	G	H
Minimum	18	0.38	0.63	2.75	3E	3D	1.75	1.50
Conventional	24	0.38	0.63	3.50	4E	4D	2.50	1.50
Oversized	30	0.50	0.75	4.50	5E	5D	3.00	1.88

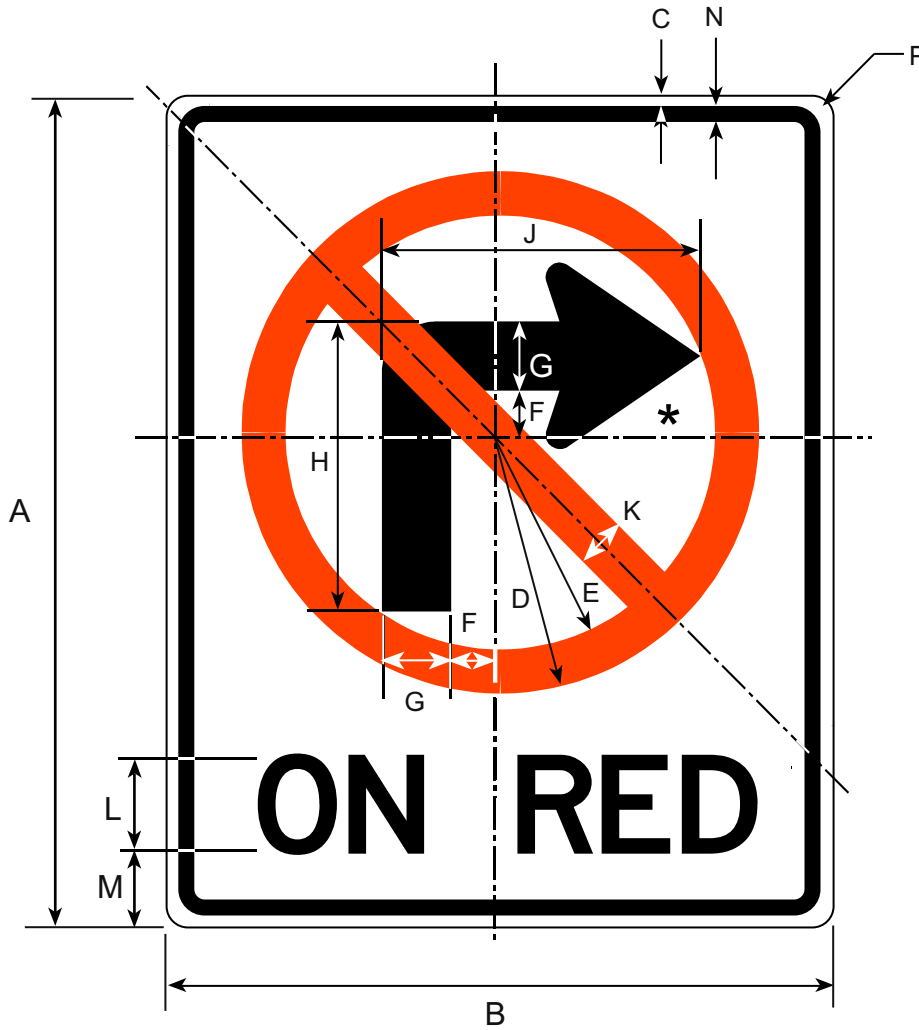

Circle, Diagonal: Red
 Arrow, Border, Legend: Black
 Background: White

*See Appendix B-1 for Standard Arrow Details.

Road Class	Dimensions (inches)														
	A	B	C	D	E	F	G	H	J	K	L	M	N	P	
Conv & Min	24	30	0.38	10.5	8.5	1.5	2.5	10.5	11.5	2.0	4D	3.5	0.63	1.5	
Expressway	30	36	0.50	13.13	10.63	1.88	3.13	13.13	14.5	2.5	5D	4.0	0.75	1.88	

R10-11D

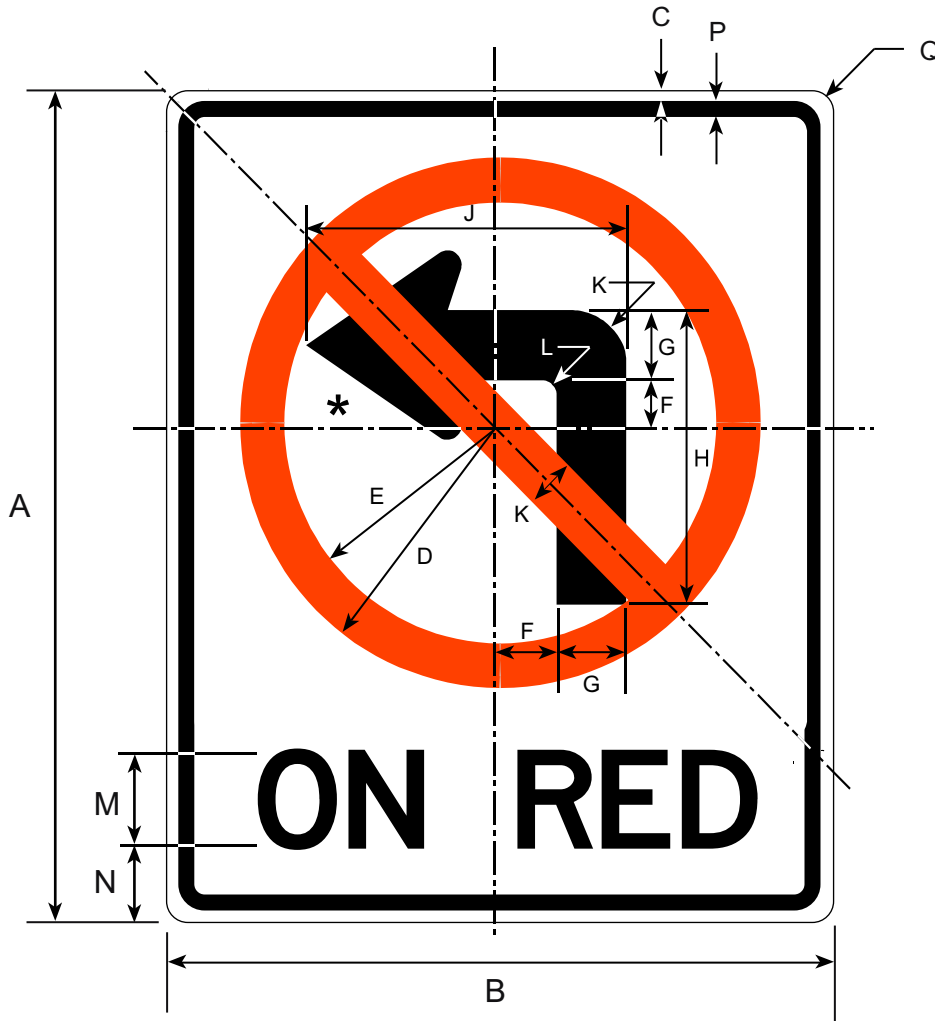

Circle, Diagonal: Red
 Arrow, Border, Legend: Black
 Background: White

*See Appendix B-1 for Standard Arrow Details.

Road Class	Dimensions (inches)															
	A	B	C	D	E	F	G	H	J	K	L	M	N	P	Q	
Conv & Min	24	30	0.38	10.5	8.5	1.5	2.5	10.5	11.5	2.0	0.50	4D	3.5	0.63	1.5	
Expressway	30	36	0.50	13.13	10.63	1.88	3.13	13.13	14.5	2.5	0.63	5D	4.0	0.75	1.88	

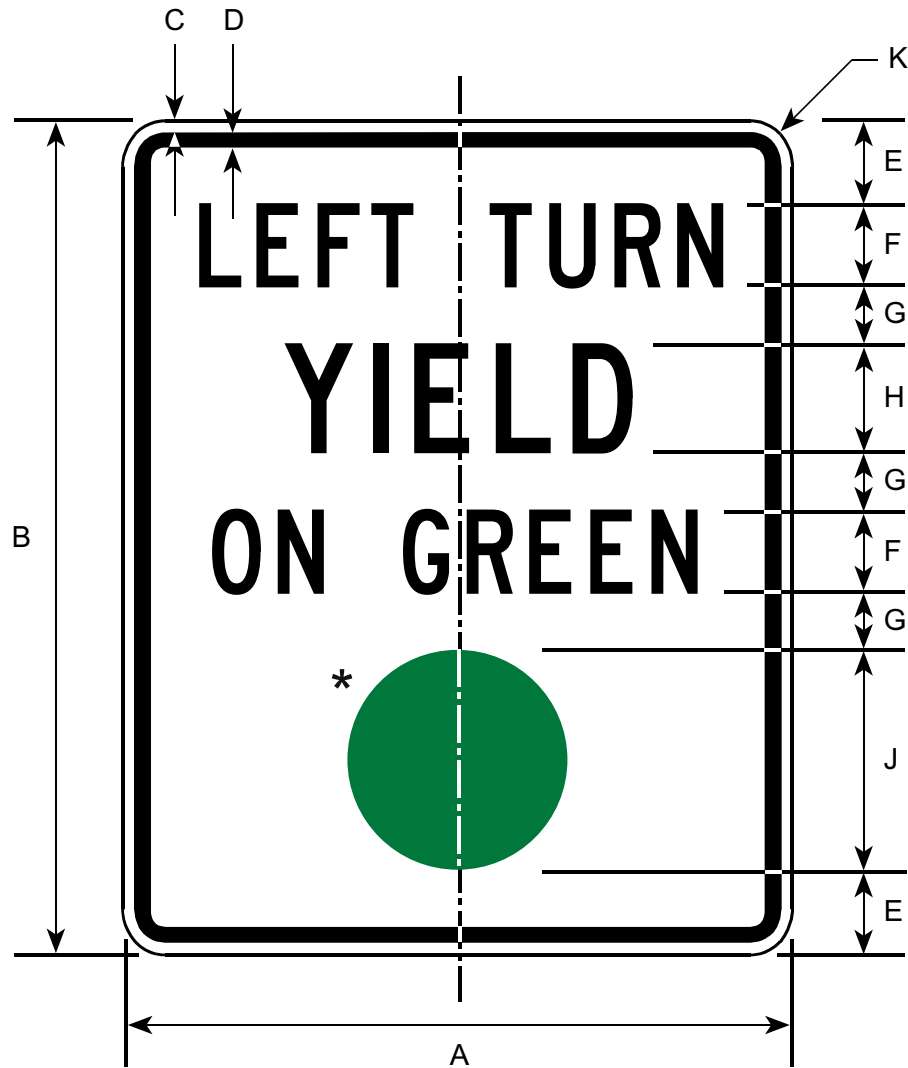

Border and Legend: Black
 Background: White
 Ball: Green

* Make symbol proportional to the one shown.

Road Class	Dimensions (inches)									
	A	B	C	D	E	F	G	H	J	K
Minimum	24	30	0.38	0.63	3	3C	2.0	4C	8	1.5
Conventional	30	36	0.50	0.75	3	4C	2.5	5C	9	2.0

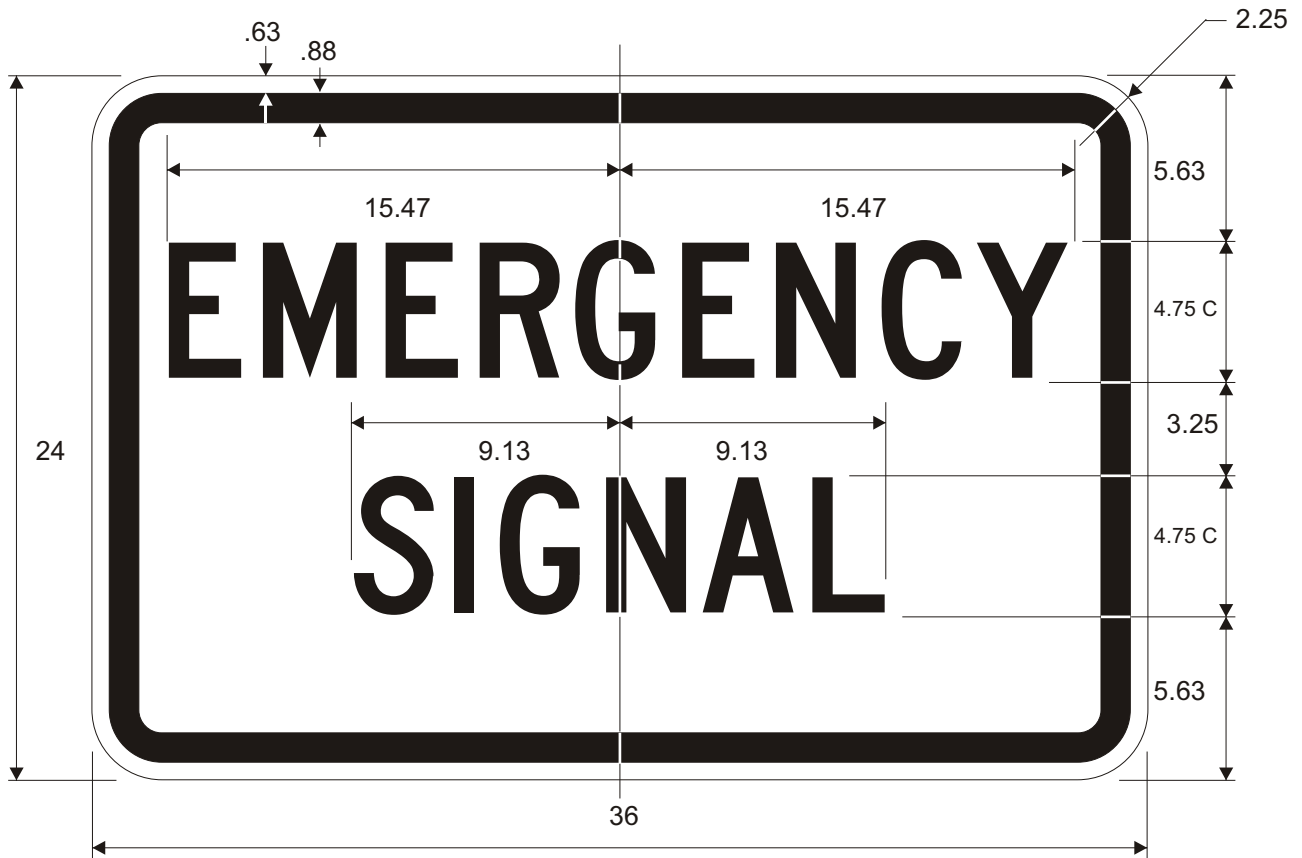

Legend and Border: Black
Background: White



Legend and Border: Black
Background: White

Road Class	Dimensions (inches)													
	A	B	C	D	E	F	G	H	J	K	L	M	N	P
Min.	24	30	0.38	0.63	4.25	2.5D	2.0	3.5D	6.76	6.39	5.67	7.17	10.53	1.5
Conv.	30	36	0.50	0.50	4.5	3D	2.75	4D	8.12	7.67	6.48	8.60	12.64	1.88
Oversized	36	42	0.63	0.88	5.75	3.5D	3.0	4.5D	9.47	8.943	7.29	10.04	14.74	2.25

R10-16

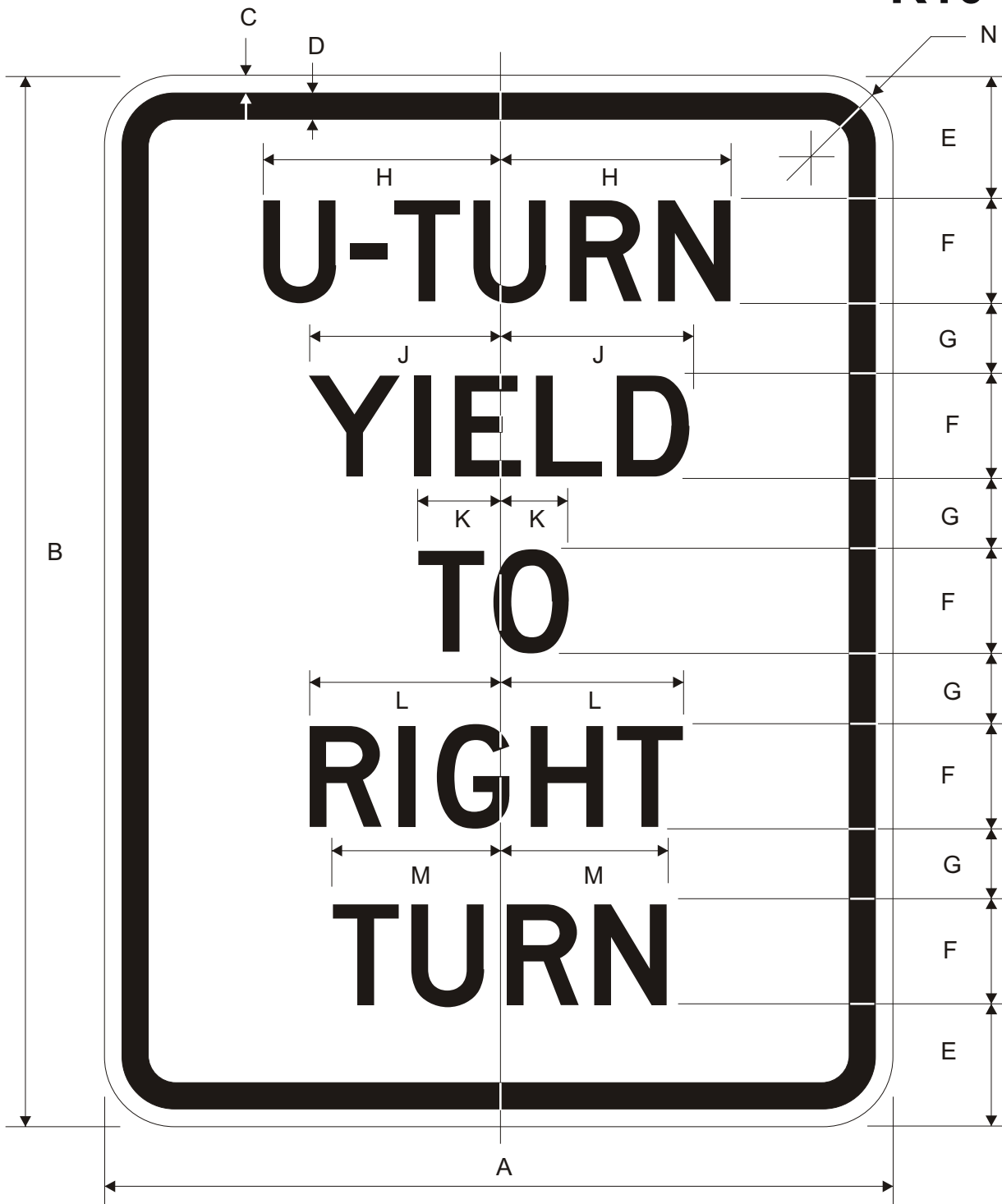

Legend and Border: Black
Background: White

Road Class	Dimensions (inches)													
	A	B	C	D	E	F	G	H	J	K	L	M	N	
Conv.	30	36	0.5	0.75	3	4D	2.5	8.89	7.31	2.90	7.13	6.41	1.88	

R10-20A

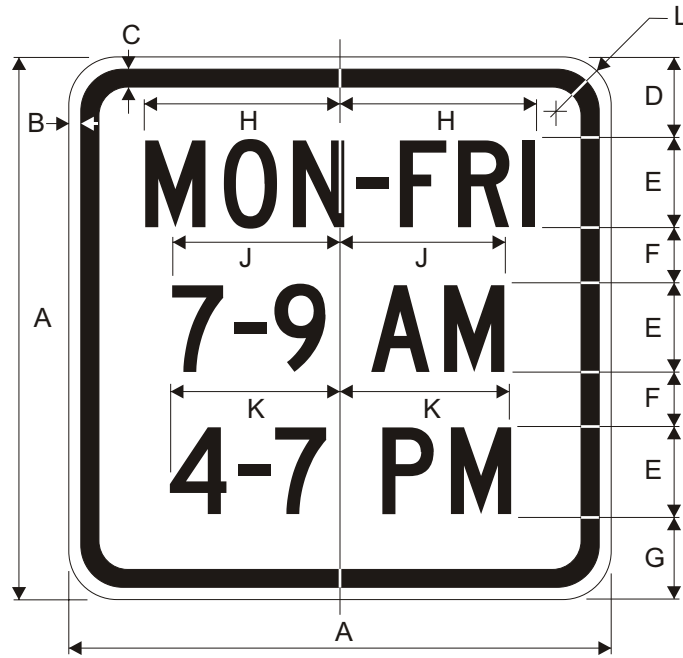

R10-20a

Road Class	Dimensions (inches)										
	A	B	C	D	E	F	G	H	J	K	L
Conv.	24	0.38	0.63	3.5	4C	2.5	3.5	8.69	7.41	7.53	1.5
Expy.	30	0.5	0.75	4.5	5C	3.0	4.5	10.85	9.24	9.39	1.88
Oversized	48	0.75	1.25	7.0	8C	5.0	7.0	17.37	14.79	15.03	3.0



R10-20a

Legend and Border: Black
Background: White

*Reduce spacing to fit.

Road Class	Dimensions (inches)										
	A	B	C	D	E	F	G	H	J	K	
Conv.	24	18	0.38	0.63	4.5	3D	3.0	7.59	6.59	1.5	
Expy.	30	24	0.50	0.75	6.0	4D	4.0	10.11	8.79	1.88	
Oversized	48	36	0.75	1.25	9.0	6D	6.0	15.8	13.18	3.0	

R10-22

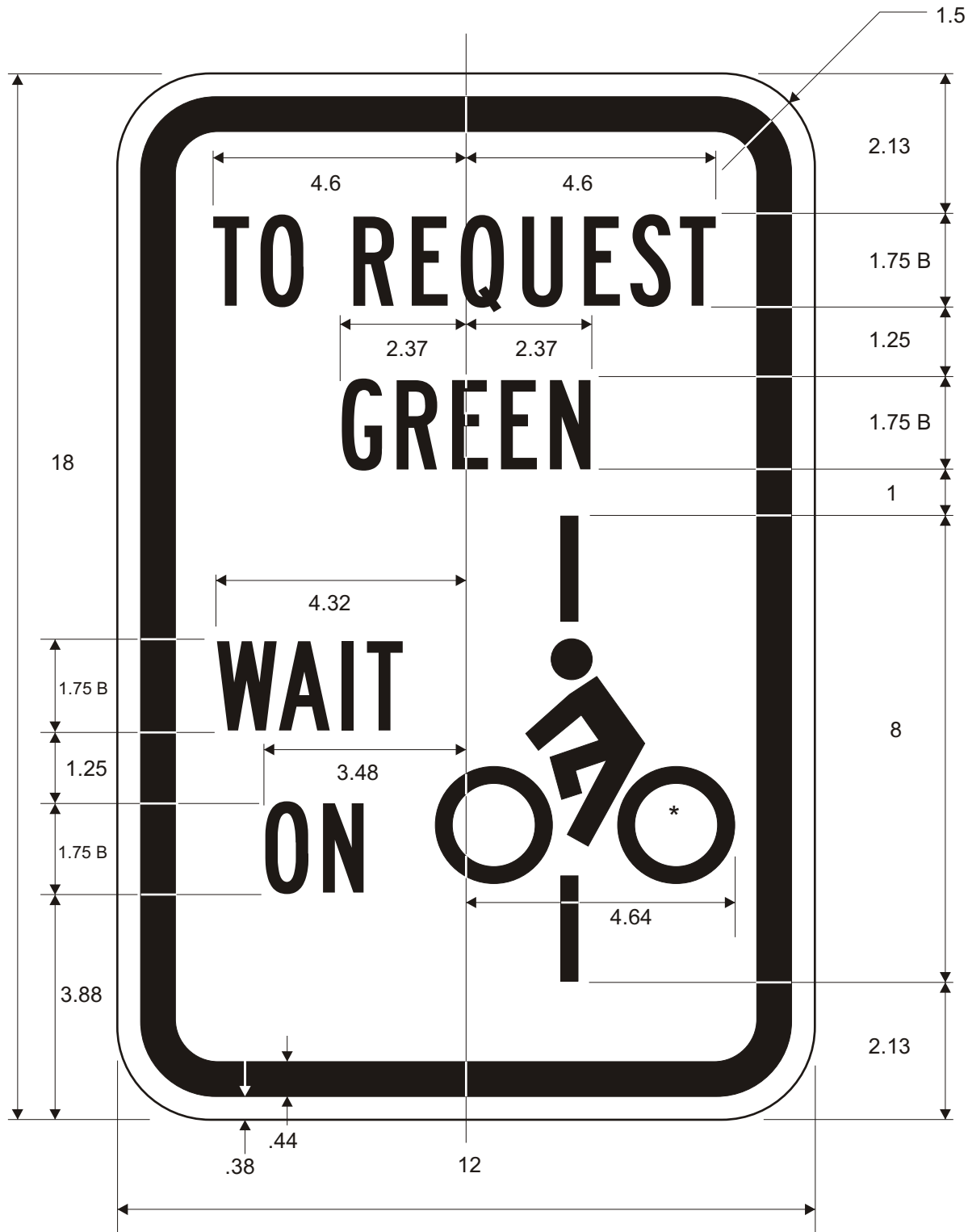

*Make symbol proportional to sign drawing.

Legend and Border: Black
Background: White

R10-100



Border and Legend: Black
 Ball: Green
 Background: White

* See R3-5L for arrow details

** Make symbol proportional to the one shown.

Prior to the 2002 publication of this manual this sign was numbered R10-13, however that sign did not include the word "GREEN".

Road Class	Dimensions (inches)																			
	A	B	C	D	E	F	G	H	J	K	L	M	N	P	Q	R	S	T	U	V
Conv & Mir	30	36	0.5	0.75	3	1.75	3.25	1.5	8	2.25	3.75	2	19	2.75	3D	1.5	0.5	2.75	6C	1.88

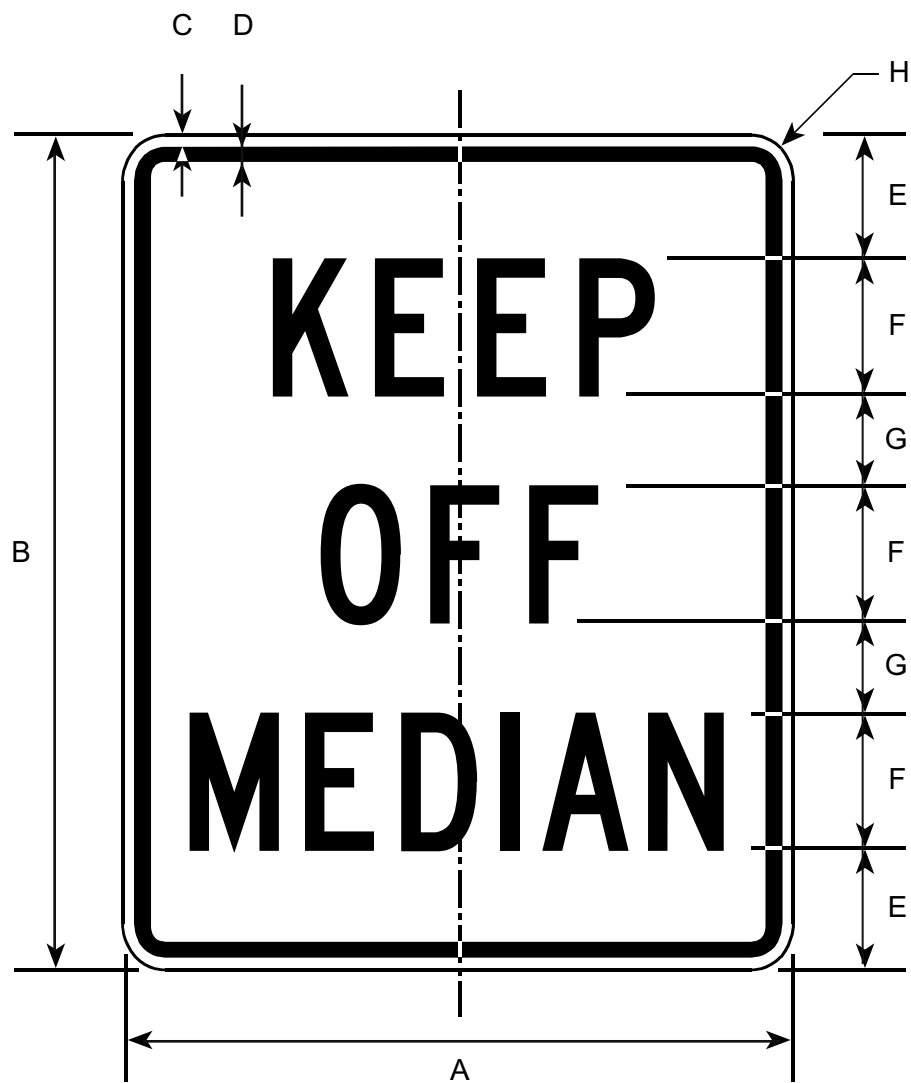

Border and Legend: Black
Background: White

Road Class	Dimensions (inches)							
	A	B	C	D	E	F	G	H
Conv & Min	24	30	0.38	0.63	4.25	5C	3.25	1.50
Expressway	36	48	0.63	0.88	6.75	8C	5.25	2.25
Freeway	48	60	0.75	1.25	8.50	10C	6.50	3.00

R11-2



Border and Legend: Black
Background: White

Road Class	Dimensions (inches)							
	A	B	C	D	E	F	G	H
Conv & Min	48	30	0.50	0.75	5	8D	4	1.88

R11-3

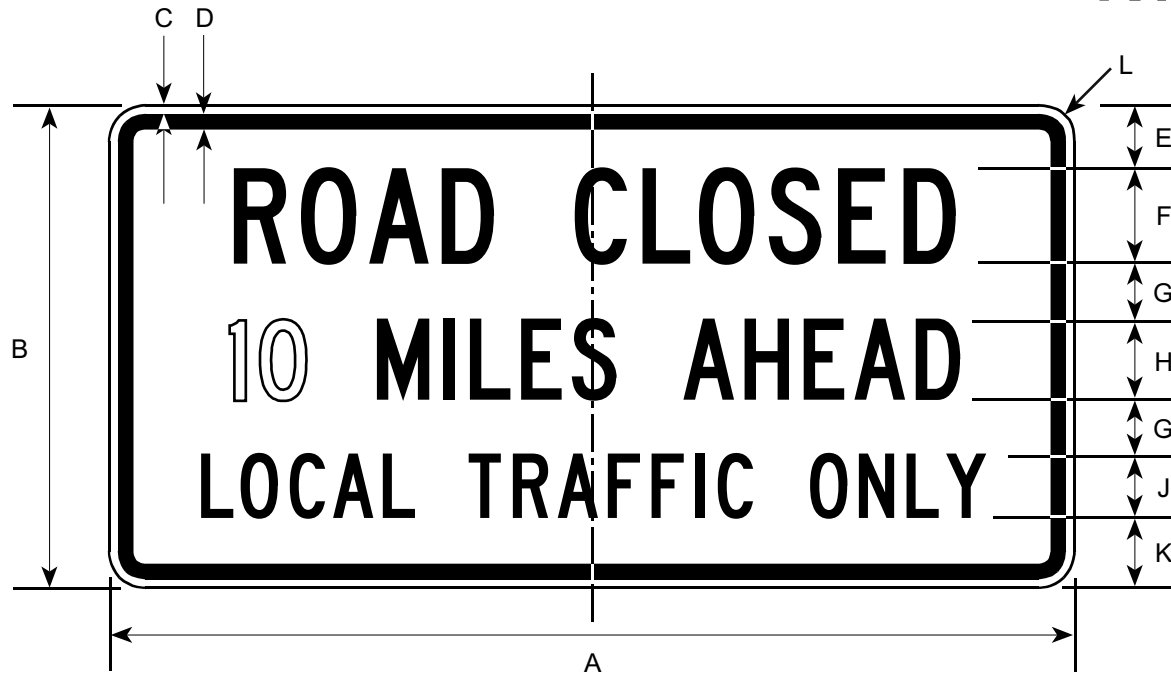

Border and Legend: Black
Background: White

Prior to the 2002 publication of this manual,
this sign was numbered R11-3A.

Road Class	Dimensions (inches)										
	A	B	C	D	E	F	G	H	J	K	L
Conv & Min	60	30	0.5	0.75	4	6C	3.38	5C	4C	4.25	1.88

R11-3A

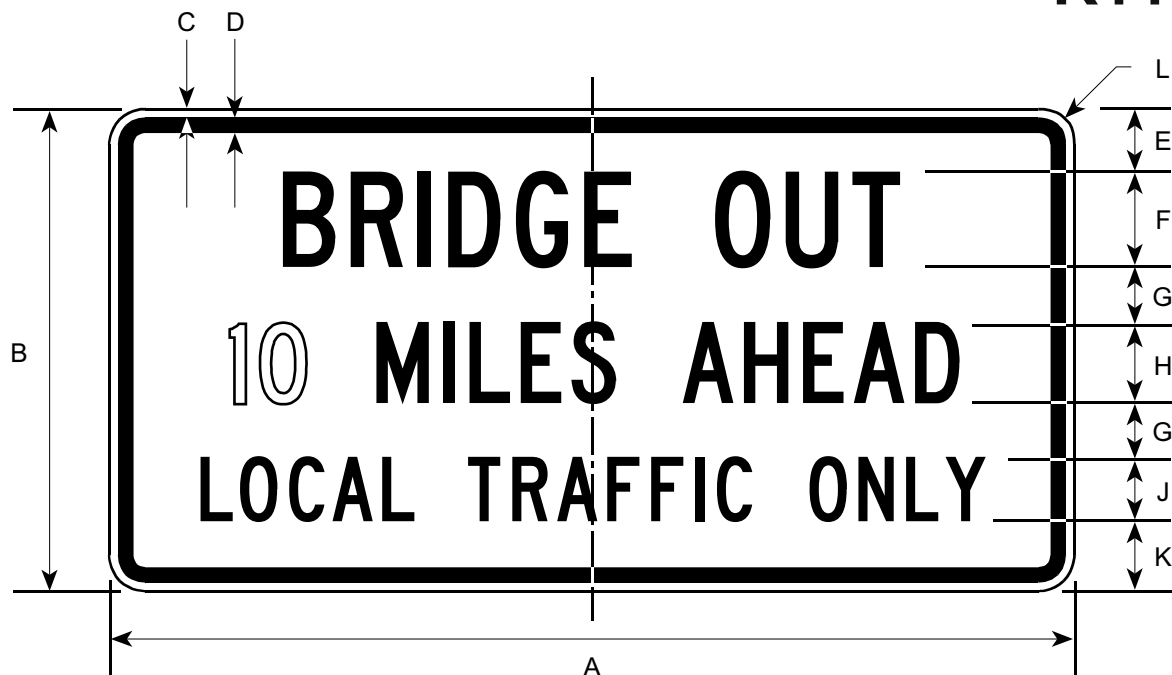

Border and Legend: Black
Background: White

Prior to the 2002 publication of this manual,
this sign was numbered R11-3B.

Road Class	Dimensions (inches)										
	A	B	C	D	E	F	G	H	J	K	L
Conv & Min	60	30	0.50	0.75	4	6C	3.38	5C	4C	4.25	1.88

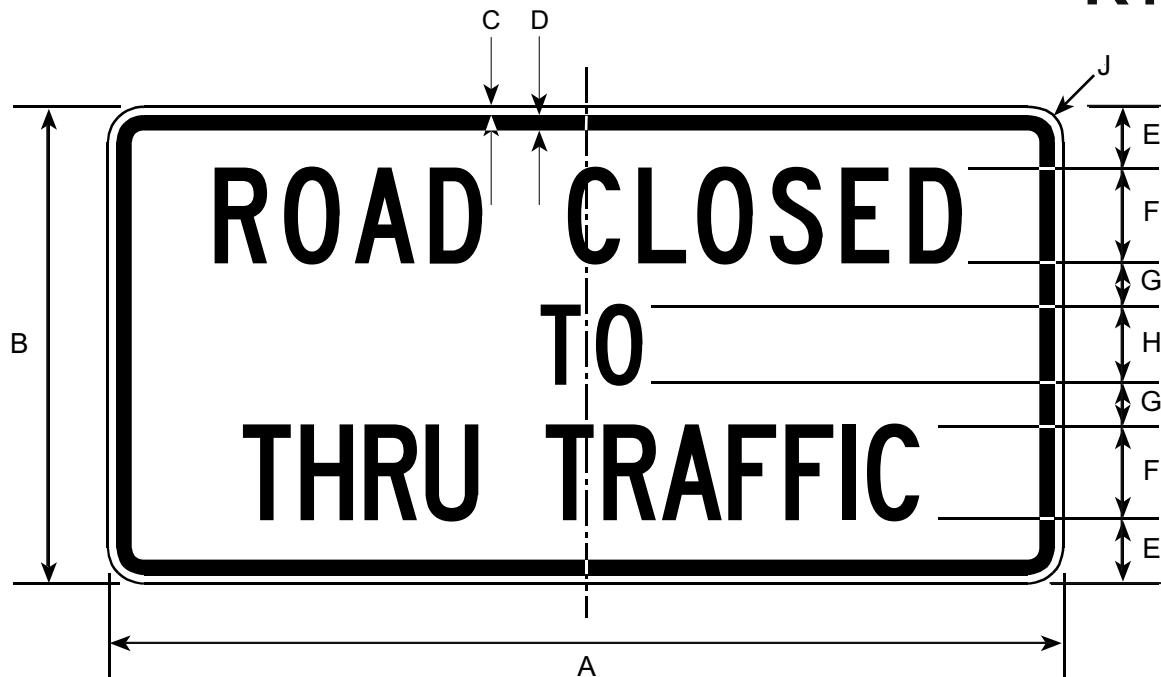

Border and Legend: Black
Background: White

Road Class	Dimensions (inches)								
	A	B	C	D	E	F	G	H	J
Conv & Min	60	30	0.5	0.75	4	6C	2.5	5C	1.88



Border and Legend: Black
Background: White

Prior to the 2002 publication of this manual,
this sign was numbered R11-5.

Road Class	Dimensions (inches)									
	A	B	C	D	E	G	H	J	K	L
Minimum	36	18	3D	2D	3.0	2.0	0.63	1.0	4.75	4.13
Conventional	48	24	4D	2D	4.0	3.0	0.88	1.5	6.19	5.50

M	N	P	Q	S	T	U	V
13.63	13.81	6.25	5.81	0.75	0.94	9.13	1.5
18.38	18.38	8.38	7.75	1.0	1.25	10.25	1.5



Border and Legend: Black
 Background: White

Prior to the 2002 publication of this manual,
 this sign was numbered R11-6.

Road Class	Dimensions (inches)								
	A	B	C	D	E	F	G	H	J
Conv & Min	60	24	0.5	0.75	5	6C	3	5C	1.88

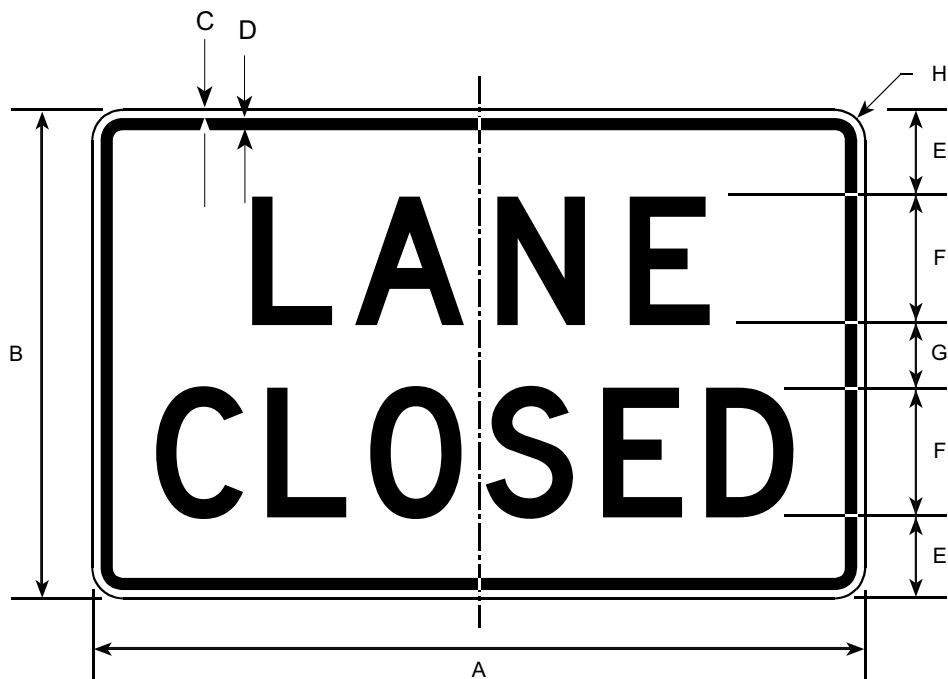

Border and Legend: Black
Background: White

Road Class	Dimensions (inches)							
	A	B	C	D	E	F	G	H
Conv & Min	48	30	0.50	0.75	5	8D	4	1.88

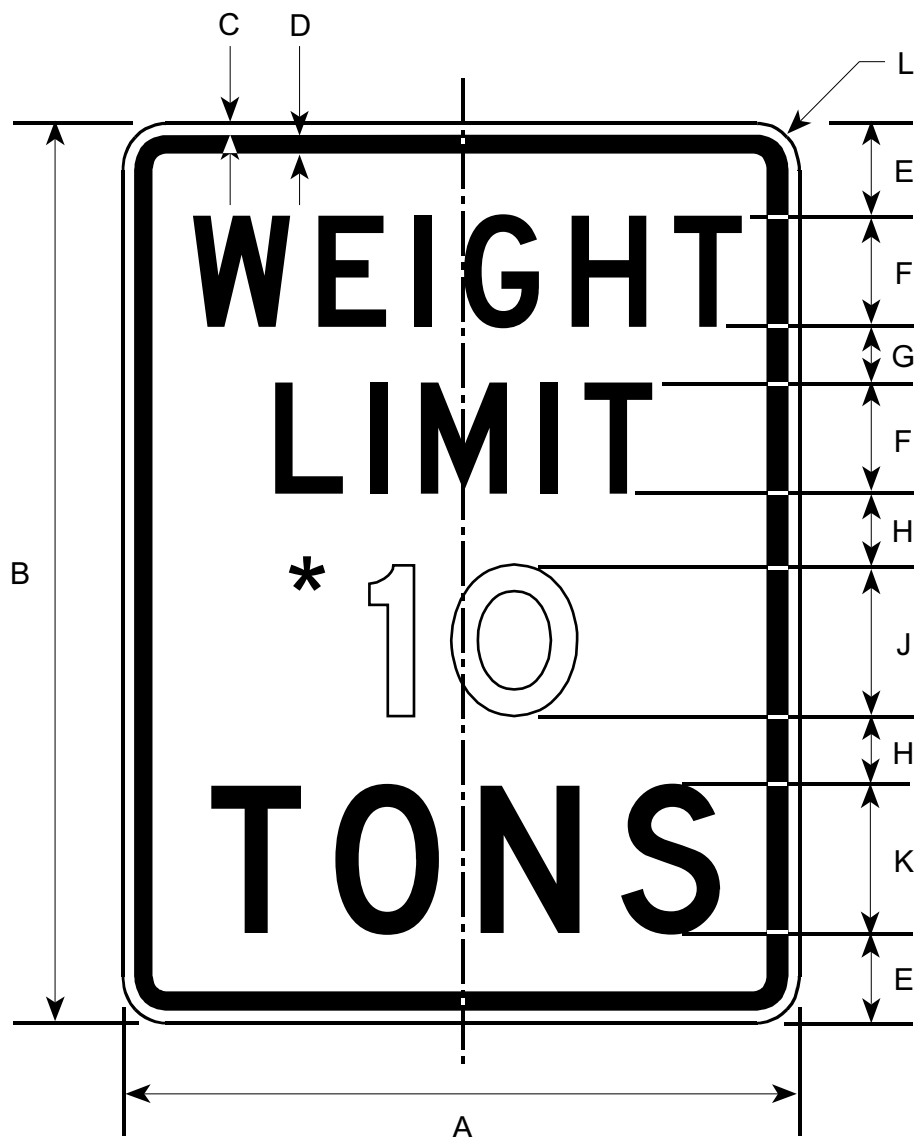

Border and Legend: Black
Background: White

* Optically space numerals
about vertical centerline

Road Class	Dimensions (inches)										
	A	B	C	D	E	F	G	H	J	K	L
Conv & Min	24	30	0.38	0.63	3.00	4D	1.75	2.63	5E	5D	1.50
Expwy & Fwy	36	48	0.63	0.88	4.75	6D	3.00	3.75	8E	8D	2.25

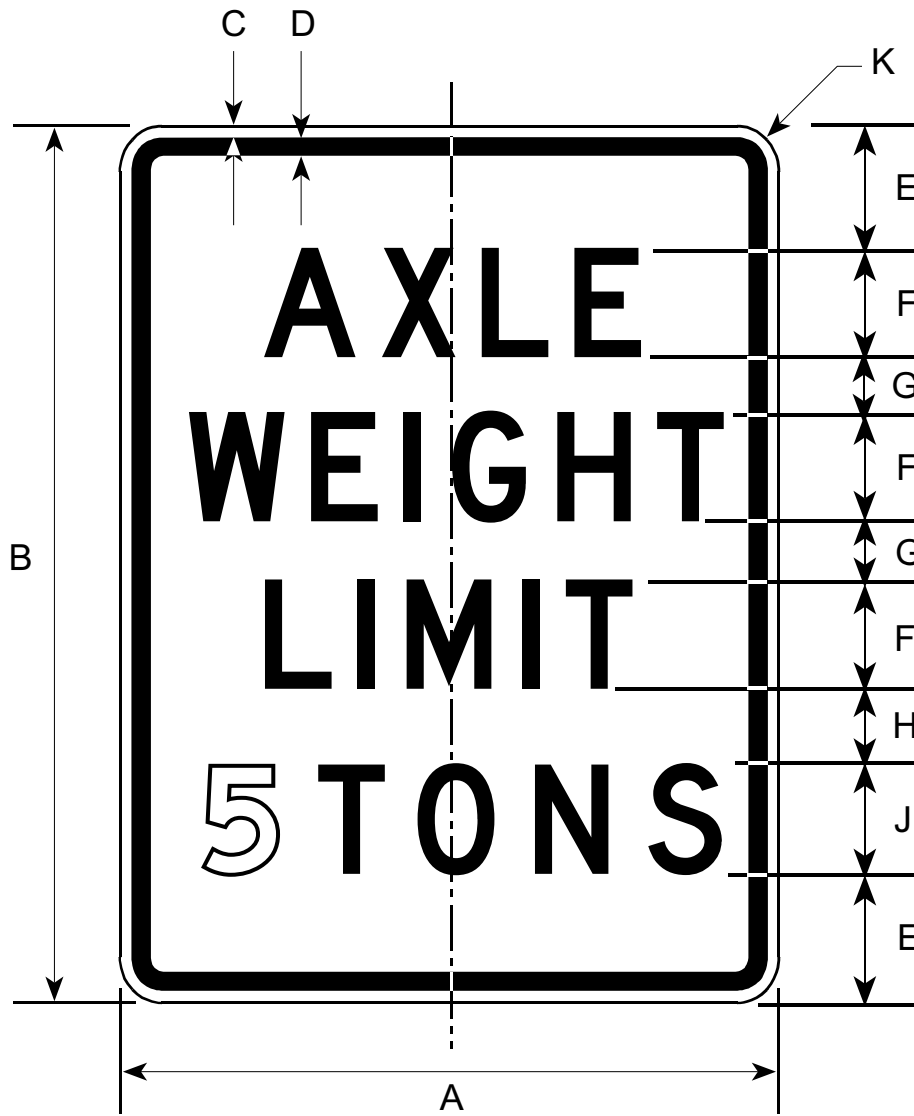

Border and Legend: Black
Background: White

Road Class	Dimensions (inches)									
	A	B	C	D	E	F	G	H	J	K
Conv & Min	24	30	0.38	0.63	3.25	4D	2.00	2.50	5D	1.50
Expwy & Fwy	36	48	0.63	0.88	5.25	6D	3.50	4.50	8D	2.25

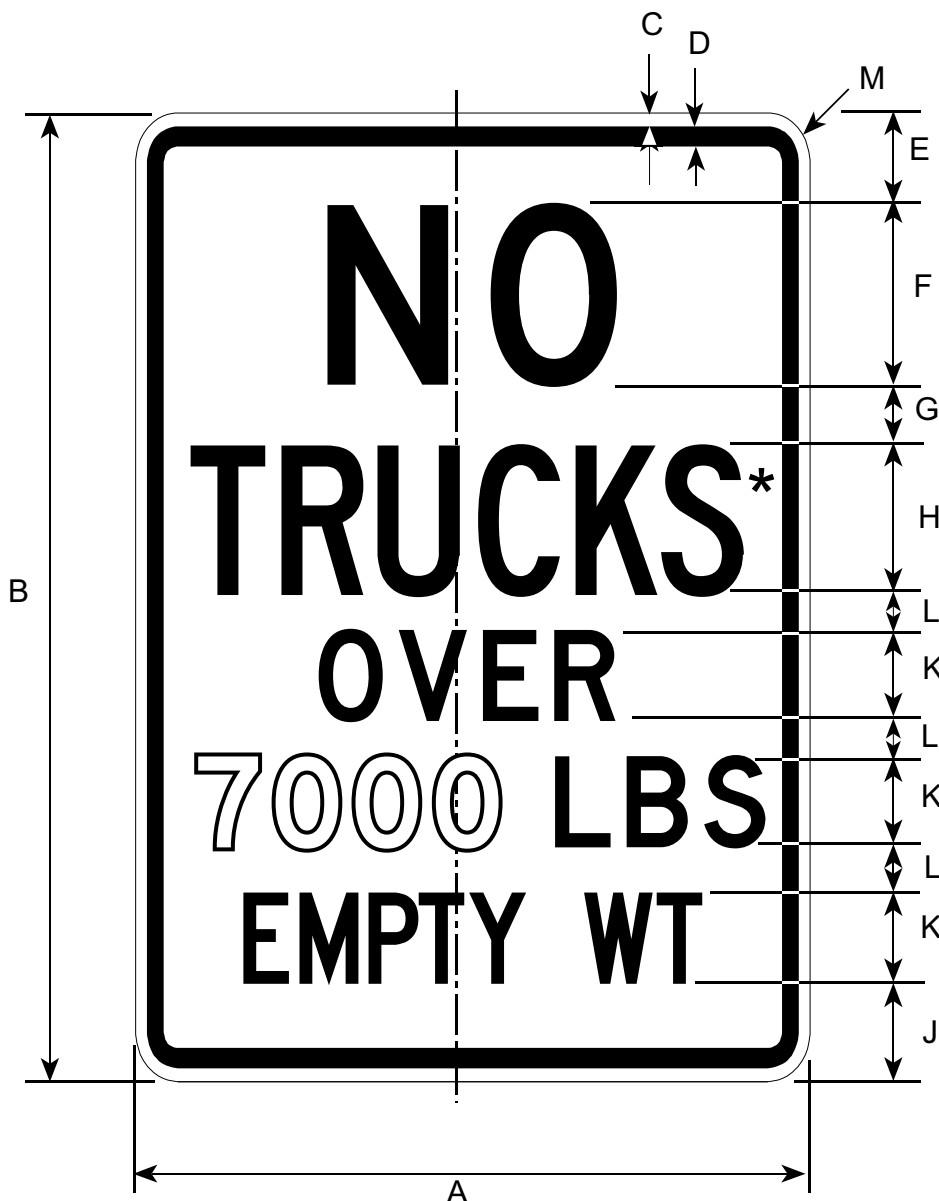

Border and Legend: Black
Background: White

* Reduce spacing 20%

Road Class	Dimensions (inches)											
	A	B	C	D	E	F	G	H	J	K	L	M
Conv & Min	24	36	0.38	0.63	3.50	6D	2.5	5C	4	3D	2	1.5

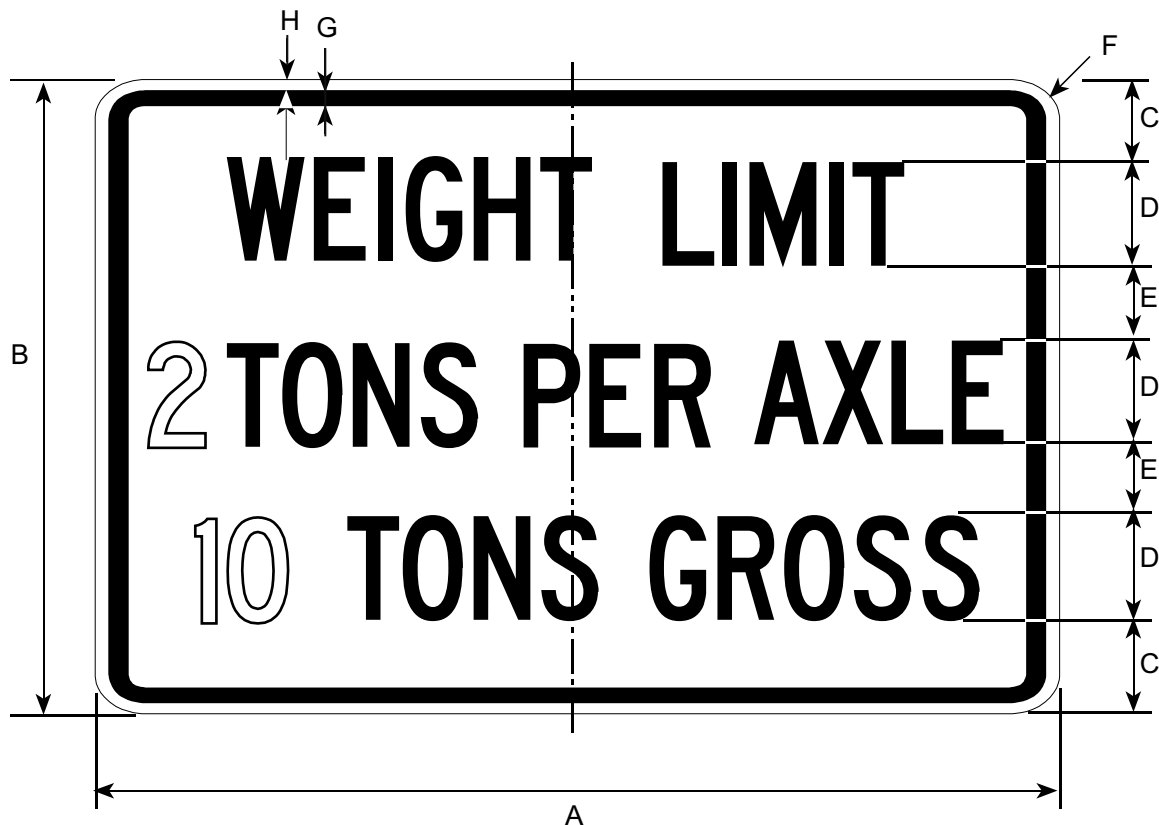

Border and Legend: Black
Background: White

Road Class	Dimensions (inches)							
	A	B	C	D	E	F	G	H
Conv & Min	36	24	3.5	4C	2.5	1.5	0.63	0.38

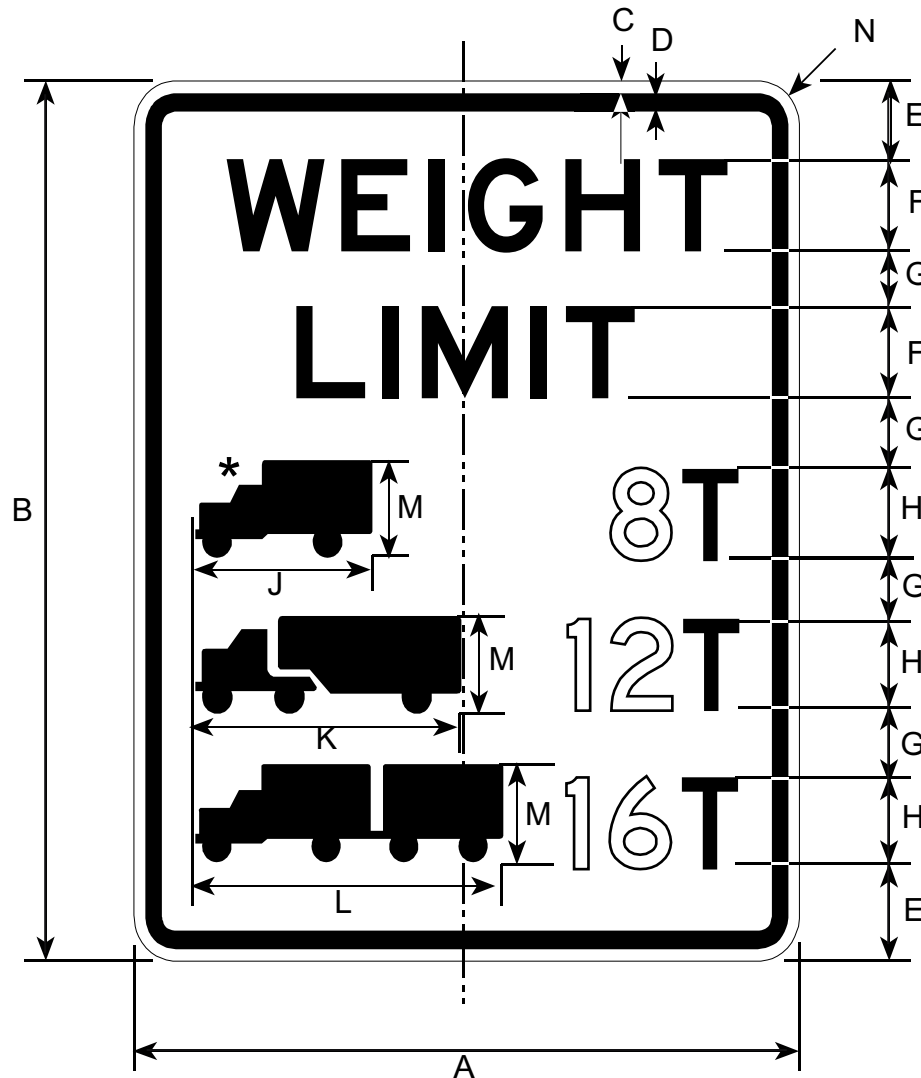

Border and Legend: Black
Background: White

* Make symbol proportional to the one shown.

Road Class	Dimensions (inches)												
	A	B	C	D	E	F	G	H	J	K	L	M	N
Minimum	24	30	0.38	0.63	3.0	3E	2.25	3D	6	9.5	11.00	3	1.50
Conventional	30	36	0.50	0.75	3.5	4E	2.25	4D	8	12.0	14.63	4	1.88
Expressway	36	48	0.63	0.88	5.0	5E	3.25	5D	10	15.0	18.38	5	2.25
Freeway	48	60	0.75	1.25	6.0	6E	4.50	6D	12	18.0	22.00	6	3.00

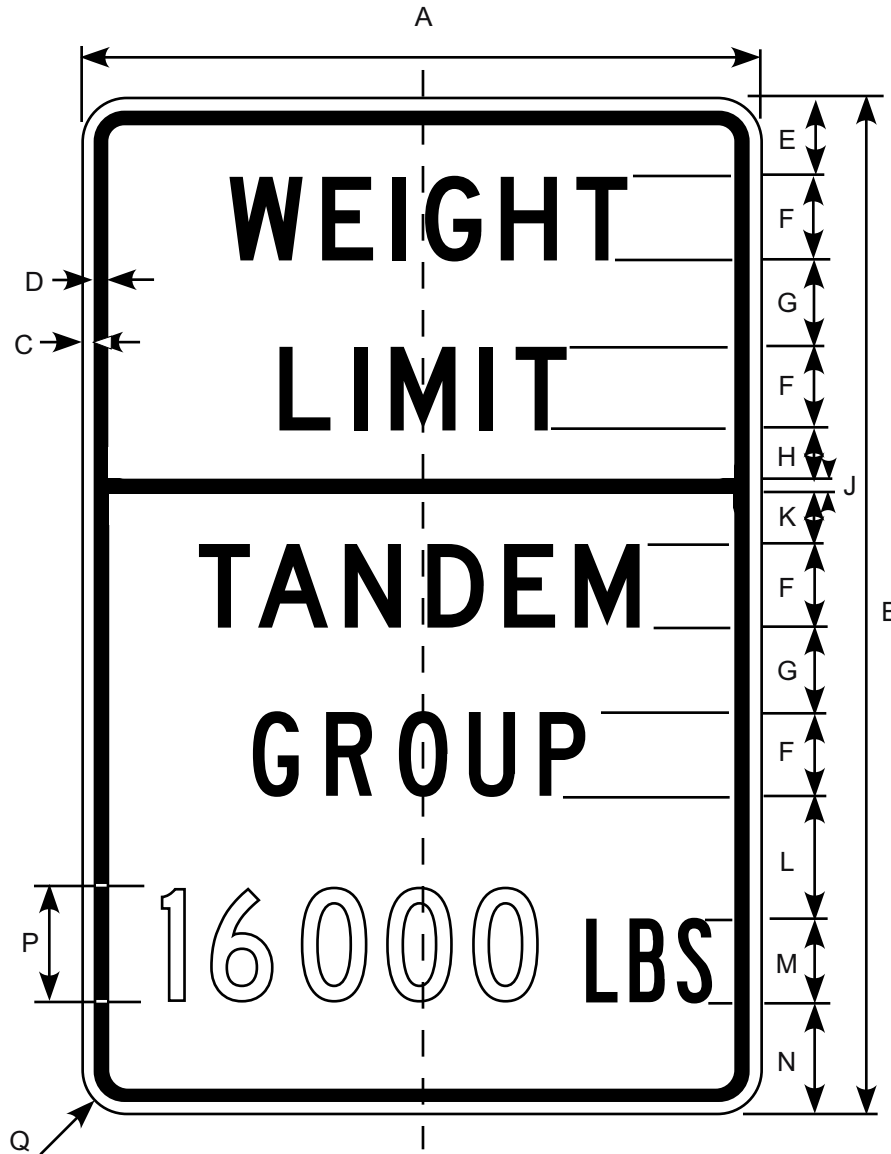

Border and Legend: Black
Background: White

Prior to the 2002 publication of this manual,
this sign was numbered R12-5A.

Road Class	Dimensions (inches)														
	A	B	C	D	E	F	G	H	J	K	L	M	N	P	Q
Conv & Min	24	36	0.38	0.63	2.75	3C	3	1.69	0.63	1.69	4.13	3B	4.13	4C	1.5

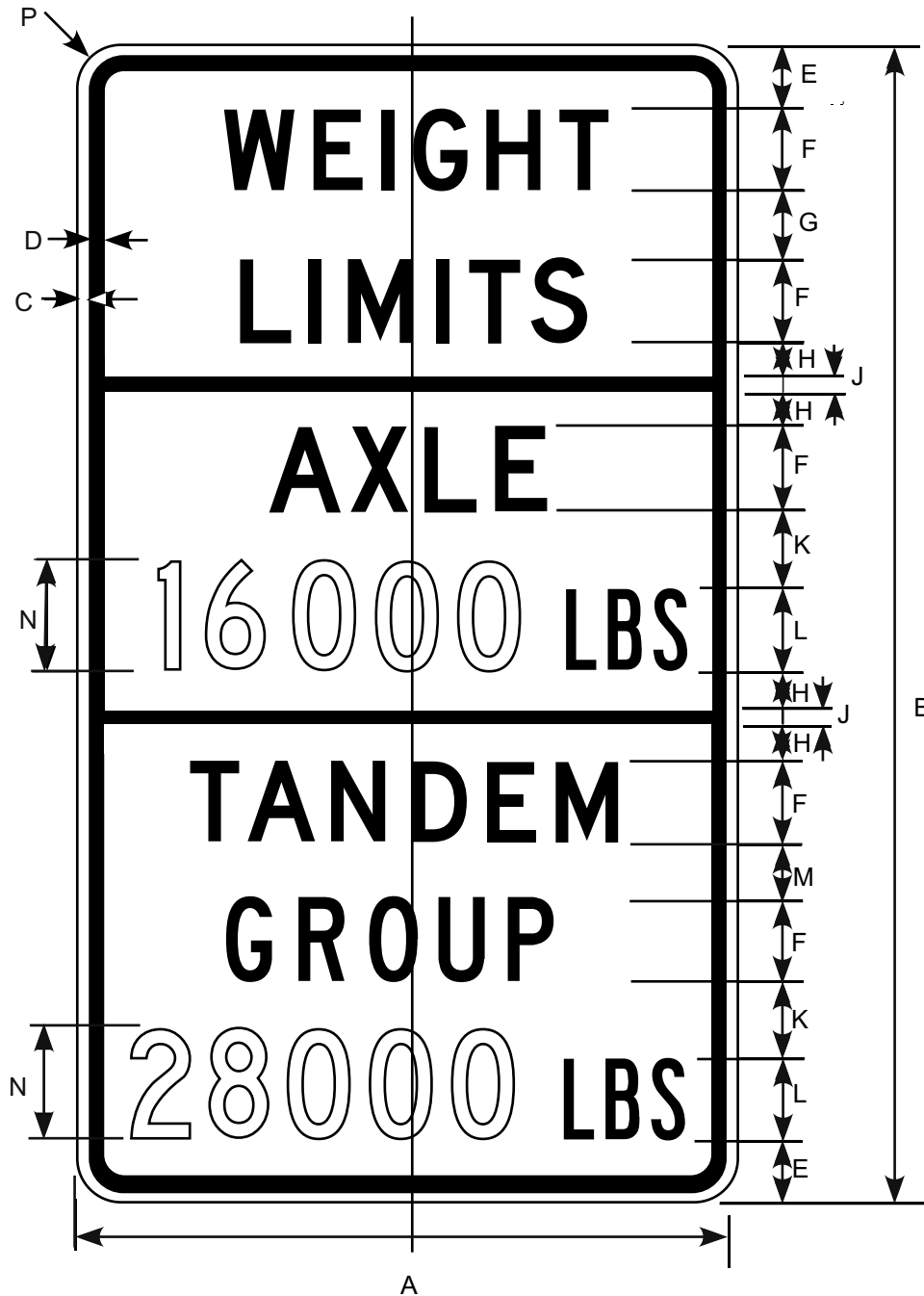

Border and Legend: Black
Background: White

Prior to the 2002 publication of this manual, this sign was numbered R12-5B.

Road Class	Dimensions (inches)													
	A	B	C	D	E	F	G	H	J	K	L	M	N	P
Conv & Min	24	42	0.38	0.63	2.25	3C	2.50	1.25	0.63	2.88	3B	2	4C	1.5

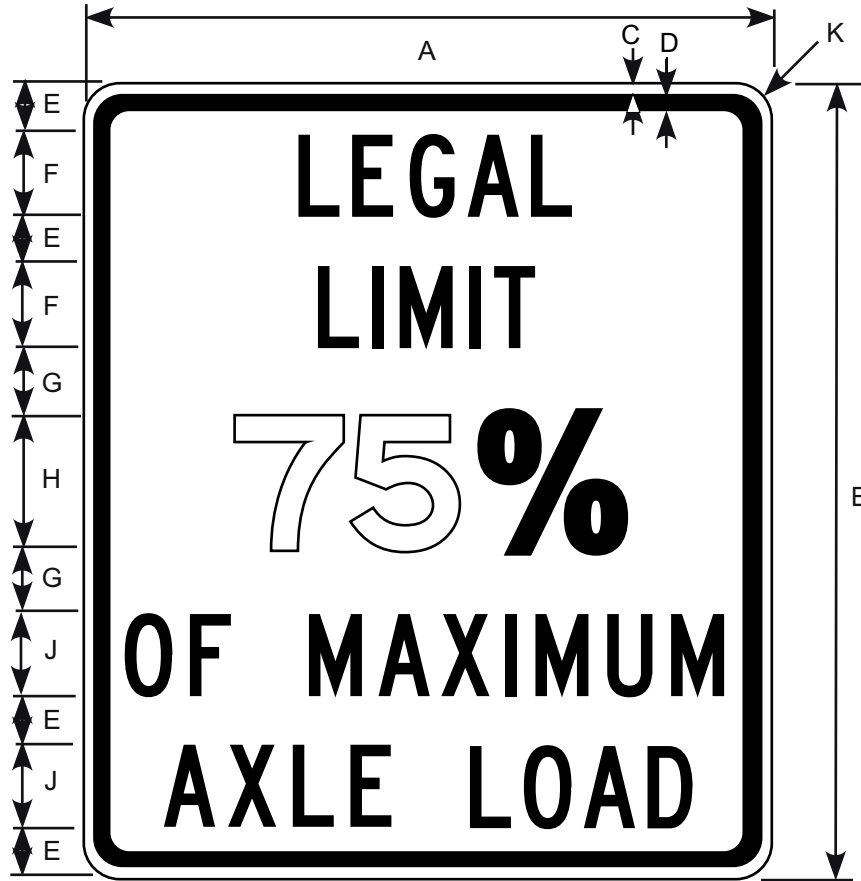

Border and Legend: Black
Background: White

Prior to the 2002 publication of this manual,
this sign was numbered R12-6.

Road Class	Dimensions (inches)									
	A	B	C	D	E	F	G	H	J	K
Conv & Min	42	48	0.63	0.88	3	5E	4	8E	5C	1.5

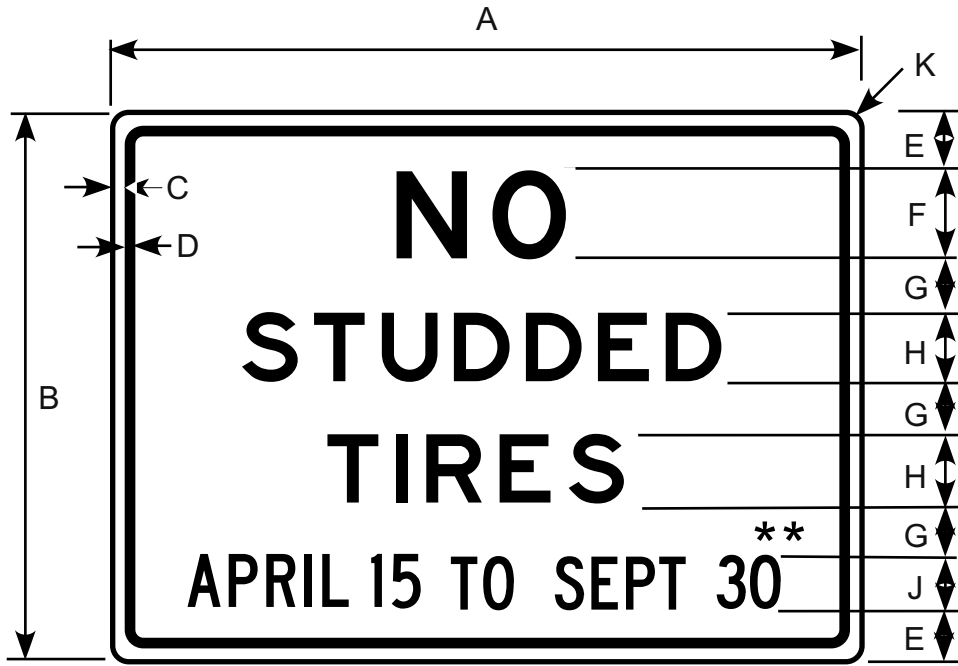

Border and Legend: Black
Background: White

- * North of 60 degrees North Latitude: May 1 to Sept. 15
- ** South of 60 degrees North Latitude: April 15 to Sept. 30

Prior to the 2002 publication of this manual,
this sign was numbered R12-7.

Road Class	Dimensions (inches)										
	A	B	C	D	E	F	G	H	J	K	
Conv & Min	84	66	1.0	1.5	8.0	10E	6.0	8E	6C	4.0	



Border and Legend: Black
Background: White

Prior to the 2002 publication of this manual,
this sign was numbered R12-8.

Road Class	Dimensions (inches)								
	A	B	C	D	E	F	G	H	J
Conv & Min	30	36	0.5	0.75	5D	4.0	5C	6.5	1.25



Border and Legend: Black
Background: White

Prior to the 2002 publication of this manual,
this sign was numbered R12-9.

Road Class	Dimensions (inches)								
	A	B	C	D	E	F	G	H	J
Conv & Min	30	36	0.5	0.75	5D	3	5C	3.5	1.25



Border and Legend: Black
Background: White

R12-10L Shown. Reverse
arrow for R12-10R.

Prior to the 2002 publication of this manual,
this sign was numbered R12-10.

*See Appendix B-1 for Standard Arrow Details.

Road Class	Dimensions (inches)									
	A	B	C	D	E	F	G	H	J	K
Conv & Min	30	36	0.50	0.75	5D	2.75	5.0	4.0	2.5	1.25

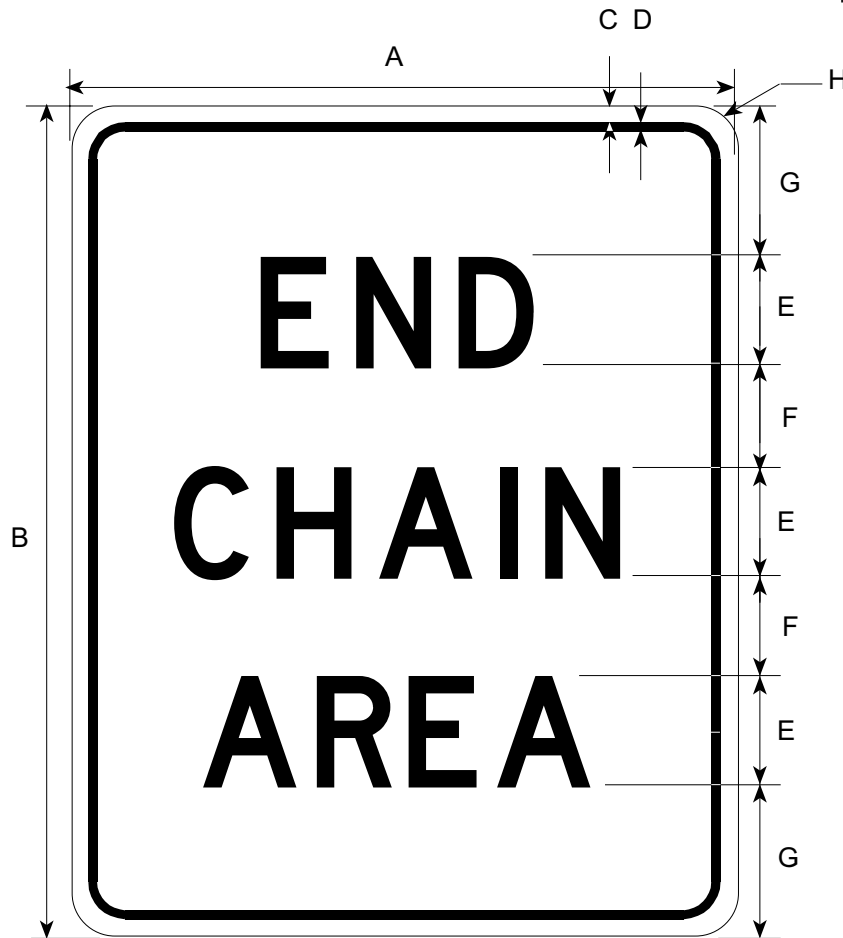

Border and Legend: Black
Background: White

Prior to the 2002 publication of this manual,
this sign was numbered R12-11.

Road Class	Dimensions (inches)							
	A	B	C	D	E	F	G	H
Conv & Min	30	36	0.5	0.75	5D	4.0	6.5	1.25

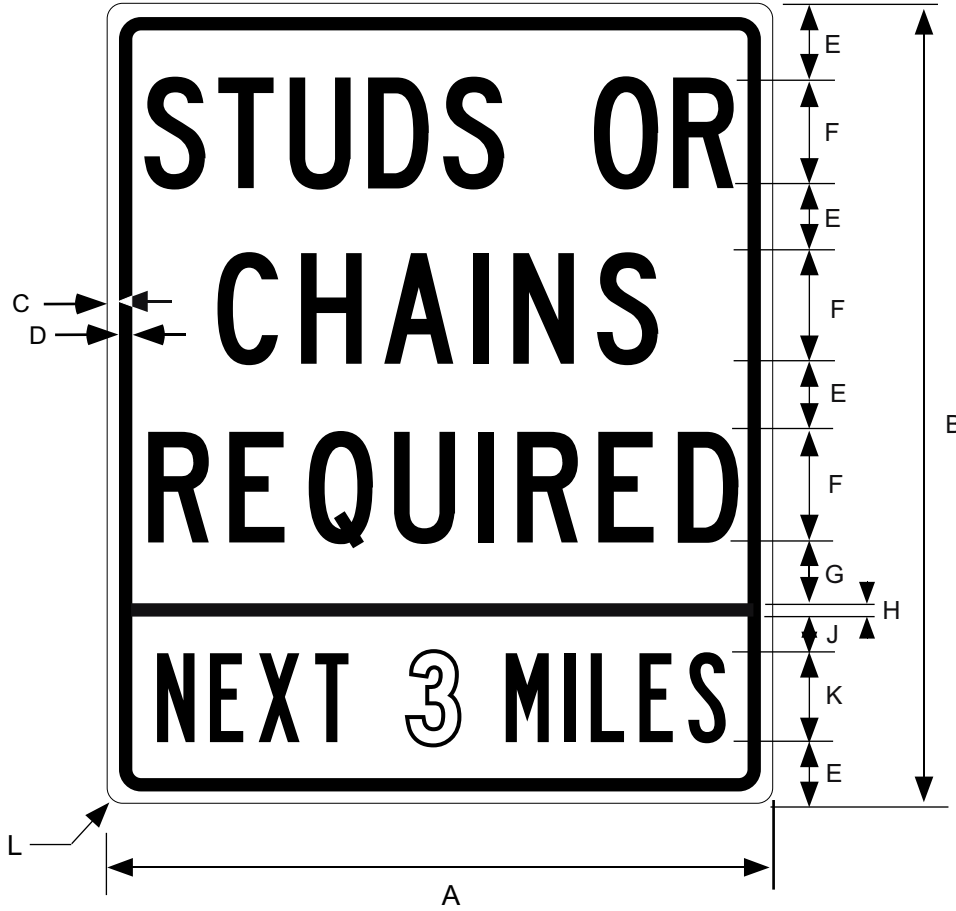

Border and Legend: Black
Background: White

Road Class	Dimensions (inches)										
	A	B	C	D	E	F	G	H	J	K	L
Min & Std	30	36	0.5	0.75	3	5C	2.63	0.75	1.63	4B	1.25

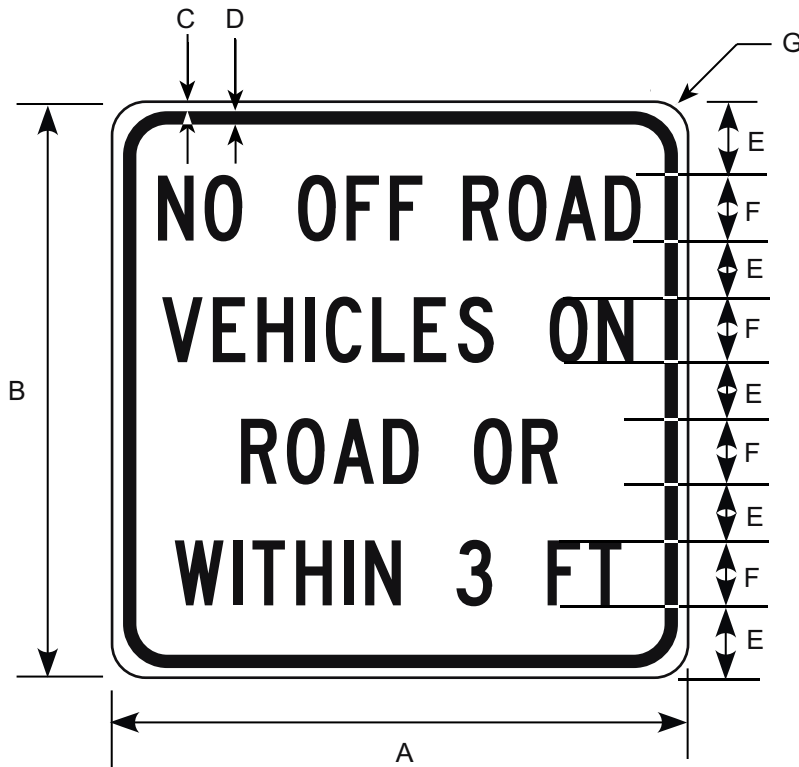

Border and Legend: Black
Background: White

Road Class	Dimensions (inches)						
	A	B	C	D	E	F	G
Conventional	36	36	0.63	0.88	4.0	4B	1.50



Border and Legend: White
Background: Black

Road Class	Dimensions (inches)						
	A	B	C	D	E	F	G
Conventional	72	48	0.75	6	6E	4	3
Expressway	96	66	0.75	8	8E	6	4
Freeway	120	84	0.75	10	10E	8	5

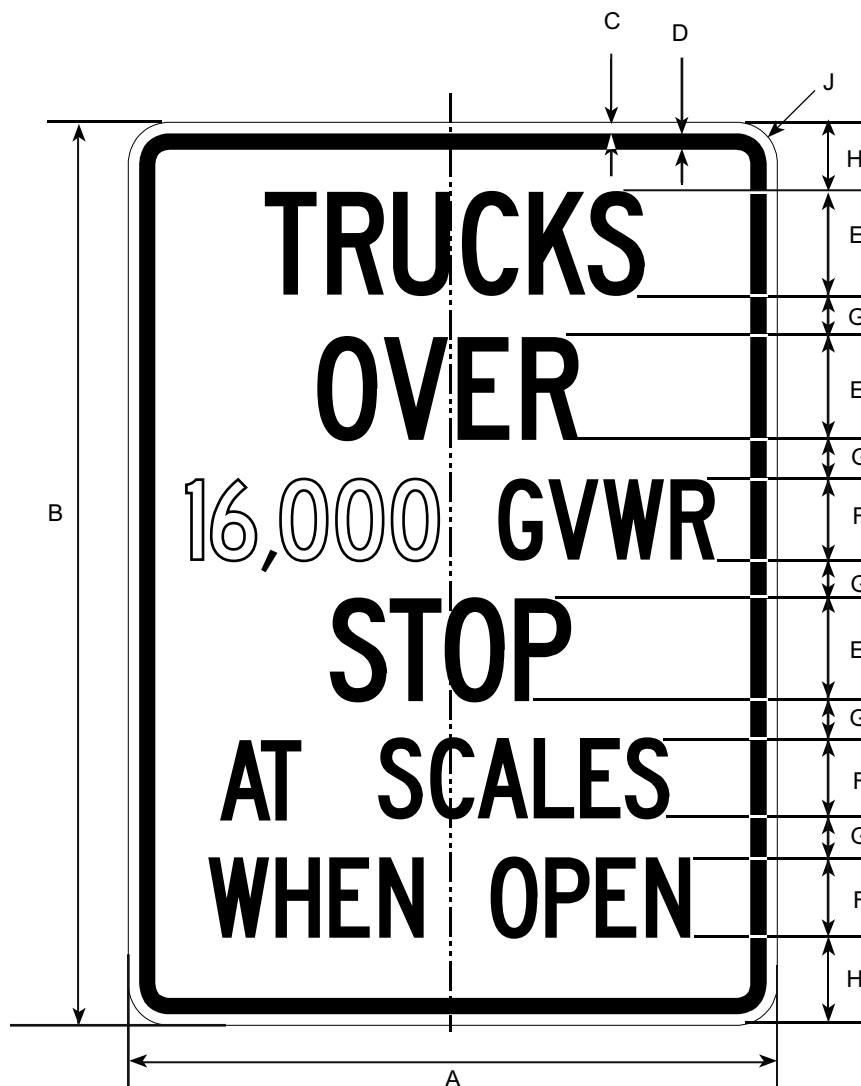

Border and Legend: Black
Background: White

Road Class	Dimensions (inches)								
	A	B	C	D	E	F	G	H	J
Conv & Min	48	72	0.8	1.25	8C	6C	4	5	3

1 1/16"x60"x0.45" SOLID BRASS PIANO HINGE COVERED TO MATCH SIGN.
 STAINLESS STEEL BOLTS AND NUTS.

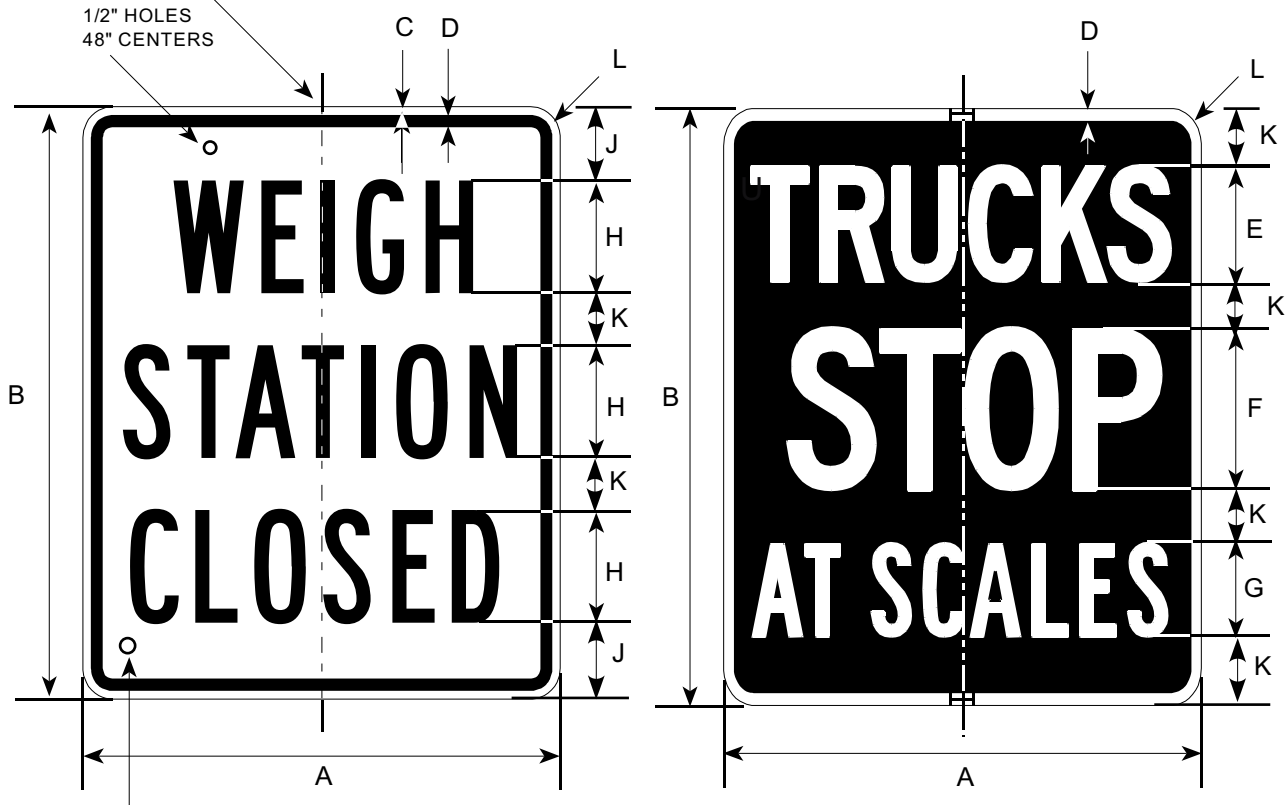

2 3/8" HOLES FOR WING-NUTS & BOLTS
 1/4 " BOLT 1/2" LONG & WING NUT (STAINLESS STEEL)

REFLECTORIZED WHITE BACKGROUND WITH BLACK LETTERS AND BORDER

REFLECTORIZED LETTERS AND BORDER ON BLACK BACKGROUND

SIGN SIZE 48"x60". THIS SIGN IS COMPRISED OF ONE FULL SIZED PANEL AND ONE HALF-SIZED PANEL. HALF OF EACH MESSAGE IS ON THE FULL-SIZED PANEL. ALSO HALF OF EACH MESSAGE IS ON THE FRONT AND BACK OF THE HALF-SIZED PANEL. SIGN LOCATION IS BETWEEN THE "WEIGH STATION RIGHT LANE" AND "WEIGH STATION" GORE SIGN.

Road Class	Dimensions (inches)									
	A	B	C	D	E	F	G	H	J	K
Conv & Min	48	60	0.75	1.25	10C	14C	8B	10B	8	7

1 1/16"x72"x0.45" SOLID BRASS PIANO HINGE COVERED TO MATCH SIGN. STAINLESS STEEL BOLTS AND NUTS.

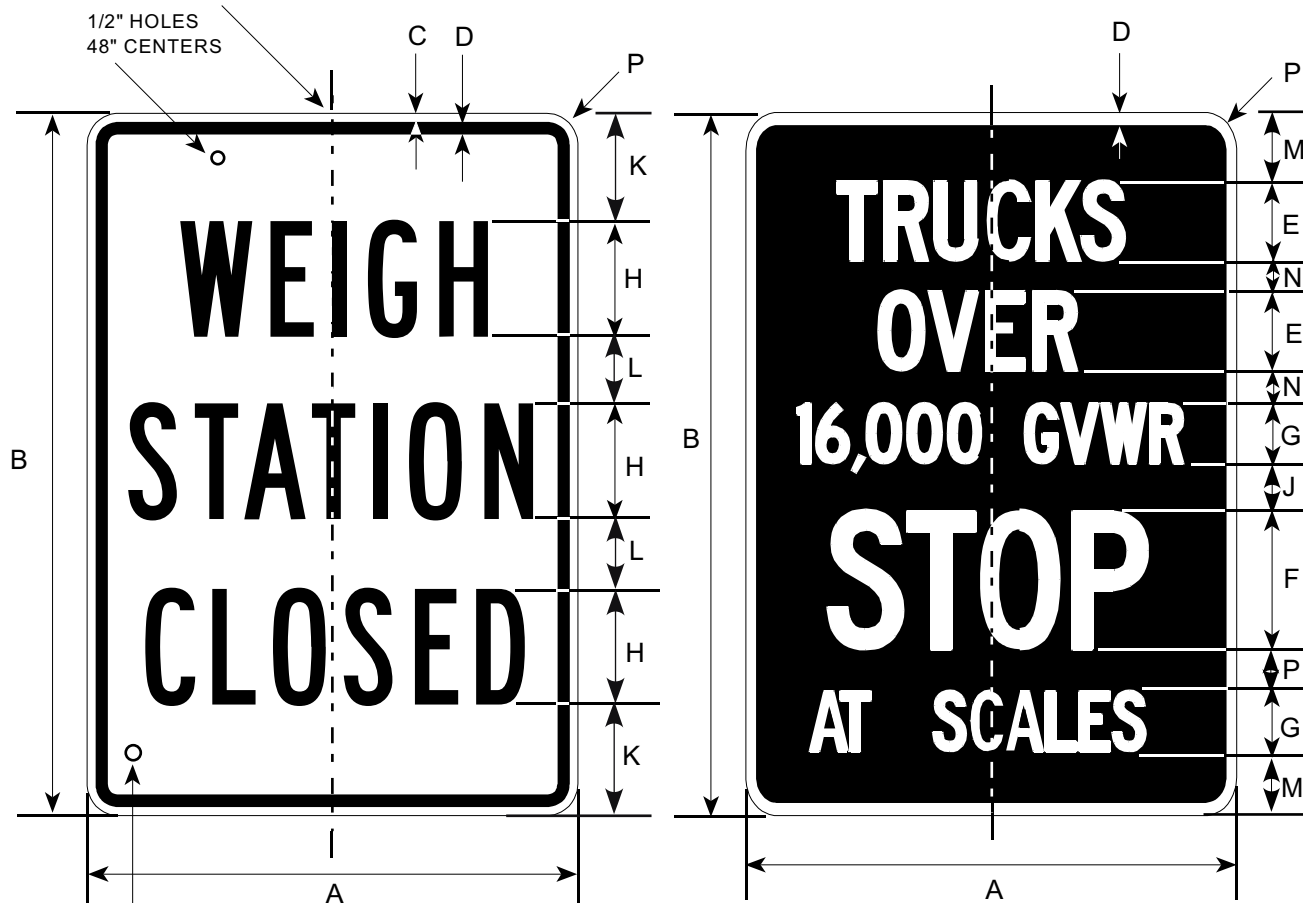

2 3/8" HOLES FOR WING-NUTS & BOLTS
1/4 " BOLT 1/2" LONG & WING NUT (STAINLESS STEEL)

REFLECTORIZED WHITE BACKGROUND WITH BLACK LETTERS AND BORDER

REFLECTORIZED LETTERS AND BORDER ON BLACK BACKGROUND

SIGN SIZE 48"x72". THIS SIGN IS COMPRISED OF ONE FULL SIZED PANEL AND ONE HALF-SIZED PANEL. HALF OF EACH MESSAGE IS ON THE FULL-SIZED PANEL. ALSO HALF OF EACH MESSAGE IS ON THE FRONT AND BACK OF THE HALF-SIZED PANEL. SIGN LOCATION IS BETWEEN THE "WEIGH STATION RIGHT LANE" AND "WEIGH STATION" GORE SIGN.

Road Class	Dimensions (inches)													
	A	B	C	D	E	F	G	H	J	K	L	M	N	P
Conv & Min	48	72	0.8	1.25	8C	14C	6C	10B	6	11	10	5	4	3

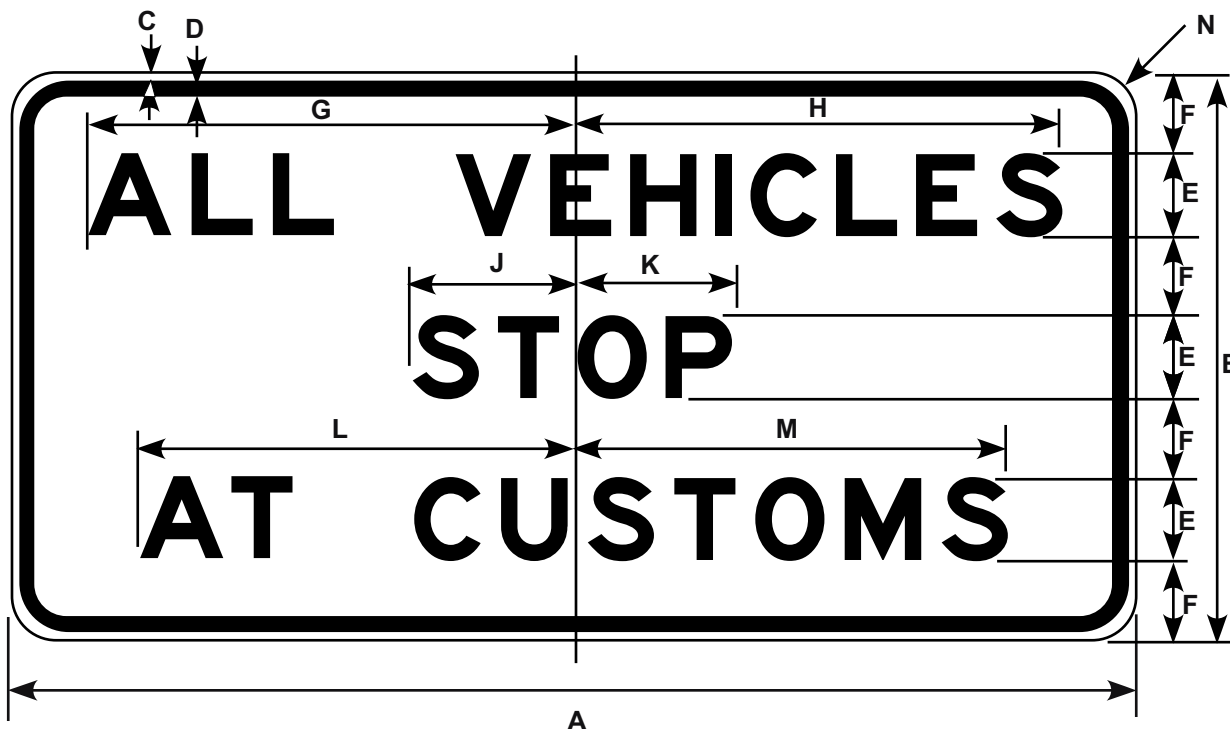

Border and Legend: Black
Background: White

Prior to the 2002 publication of this manual,
this sign was numbered R13-2.

Road Class	Dimensions (inches)													
	A	B	C	D	E	F	G	H	J	K	L	M	N	
Conv & Min	84	42	1.25	0.75	6E	6.0	35	34.75	11.5	11.5	31.13	31.13	6.0	
Expressway	108	54	1.25	0.75	8E	7.5	46.38	46.38	15.63	15.0	41.5	41	7.0	
Freeway	132	66	1.5	0.88	10E	9.0	58	58	19.25	19.0	52	51.63	8.0	

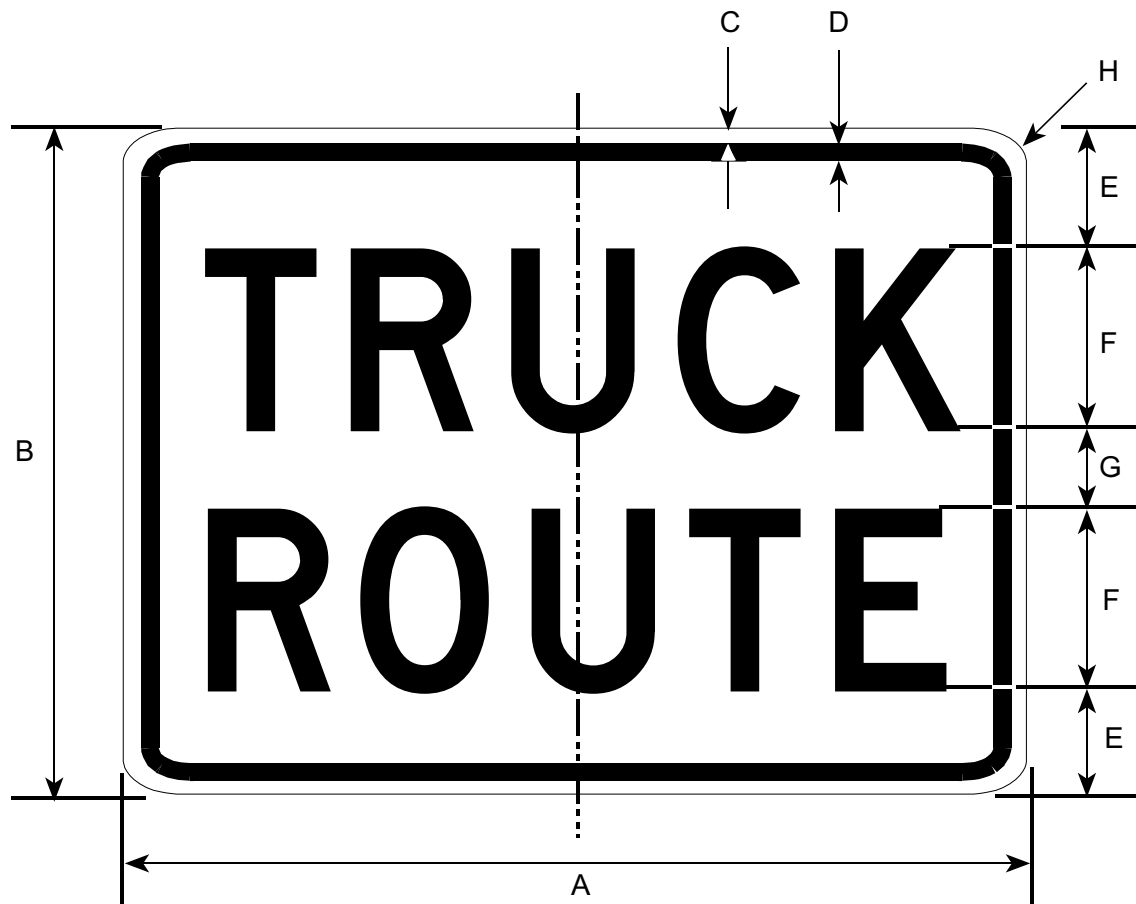

Border and Legend: Black
Background: White

Road Class	Dimensions (inches)							
	A	B	C	D	E	F	G	H
Conv & Min	24	18	0.38	0.63	3	5D	2	1.5

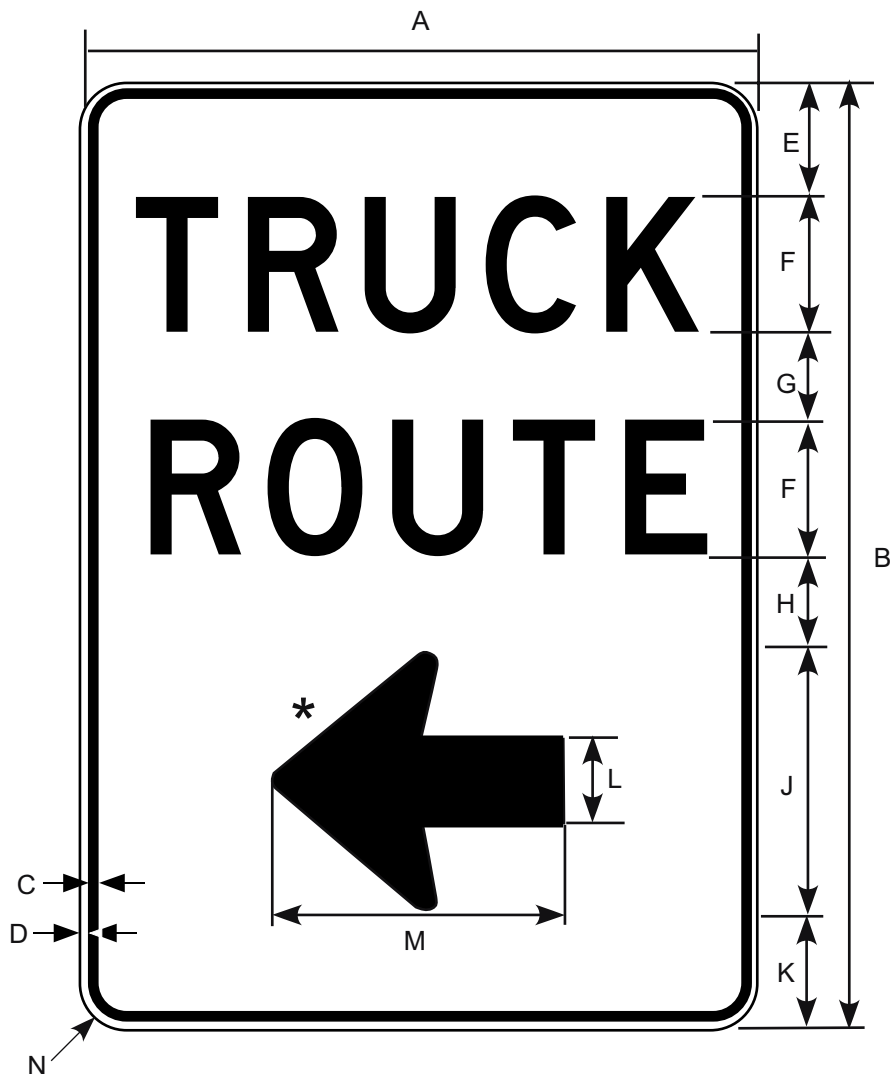

Border and Legend: Black
Background: White

*See Appendix B-1 for Standard Arrow Details.

Road Class	Dimensions (inches)												
	A	B	C	D	E	F	G	H	J	K	L	M	N
Conventional	30	42	0.75	0.50	5.0	6D	4.0	3.0	14.25	3.75	3.88	12.75	1.88

R14-2

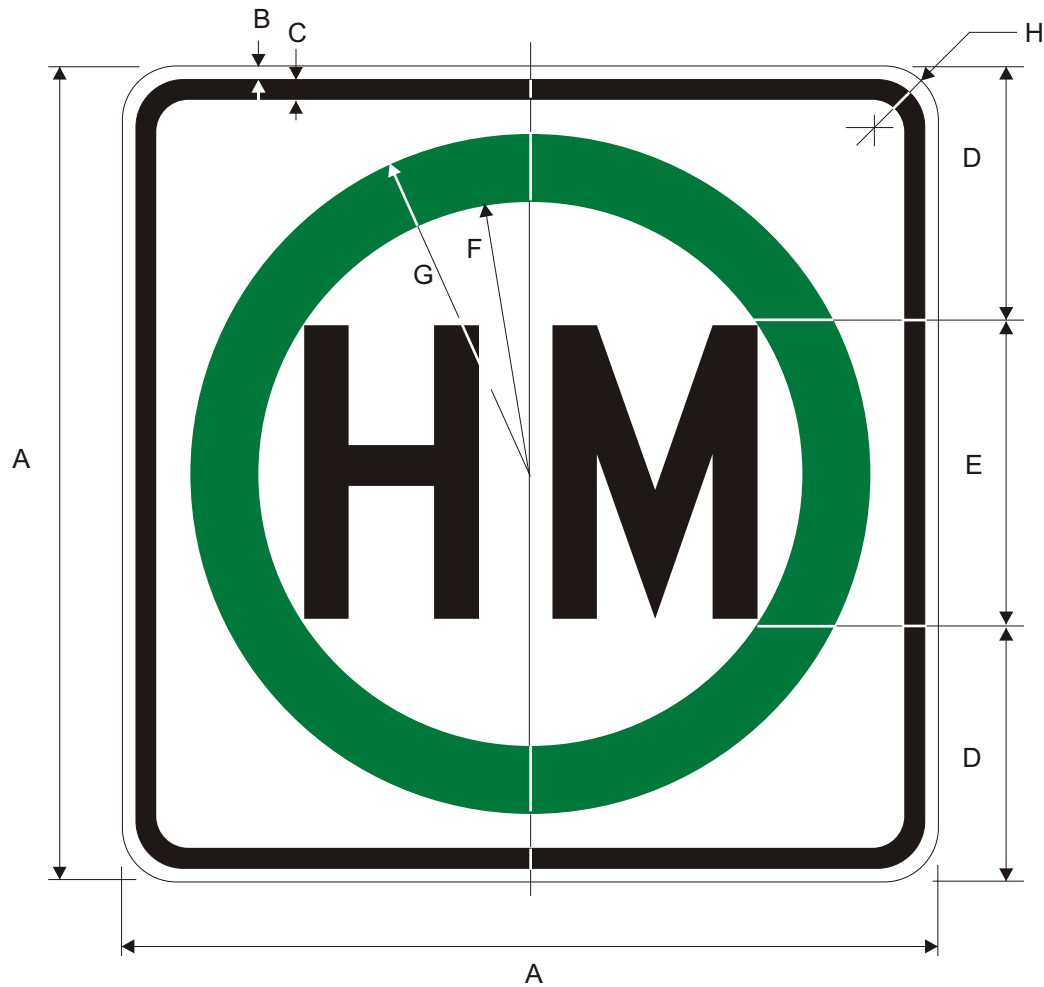

Circle: Green
 Border and Letter: Black
 Background: White

Road Class	Dimensions (inches)							
	A	B	C	D	E	F	G	H
Conv.	24	0.38	0.63	7.5	9C	8.0	10	1.5
Expy.	30	0.50	0.75	10	10C	10	12.5	1.88
Fwy.	36	0.63	0.88	12	12C	12	15	2.25
Oversized	42	0.63	0.88	14	14C	14	17.5	2.25



Circle and Diagonal: Red
 Border and Letter: Black
 Background: White

Road Class	Dimensions (inches)								
	A	B	C	D	E	F	G	H	J
Conv.	24	0.38	0.63	7.5	9C	8.0	10	2.0	1.5
Expy.	30	0.5	0.75	10	10C	10	12.5	2.5	1.88
Fwy.	36	0.63	0.88	12	12C	12	15	3.0	2.25
Oversized	42	0.63	0.88	14	14C	14	17.5	3.5	2.25

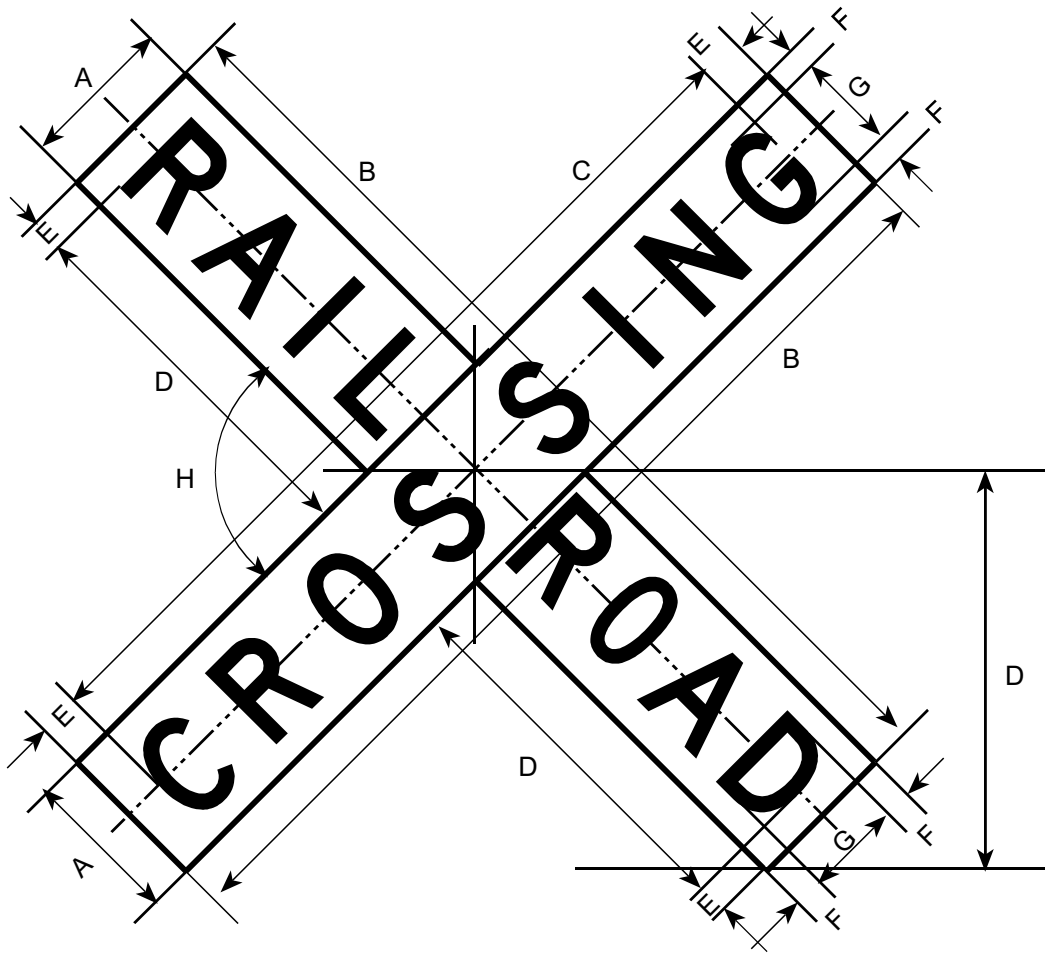

Border and Legend: Black
Background: White

NOTE: A strip of high intensity or brighter retroreflective white material not less than six inches in width shall be installed on the back of each blade of each crossbuck sign for the length of each blade. Also, a two inch strip of the same material shall be installed for the full length of the front and back of each support from the crossbuck sign or Number of Tracks (R15-2) sign to near ground level.

Road Class	Dimensions (inches)							
	A	B	C	D	E	F	G	H
Conv & Mi	9	48	45	18	1.5	1.75	5.5D	90°

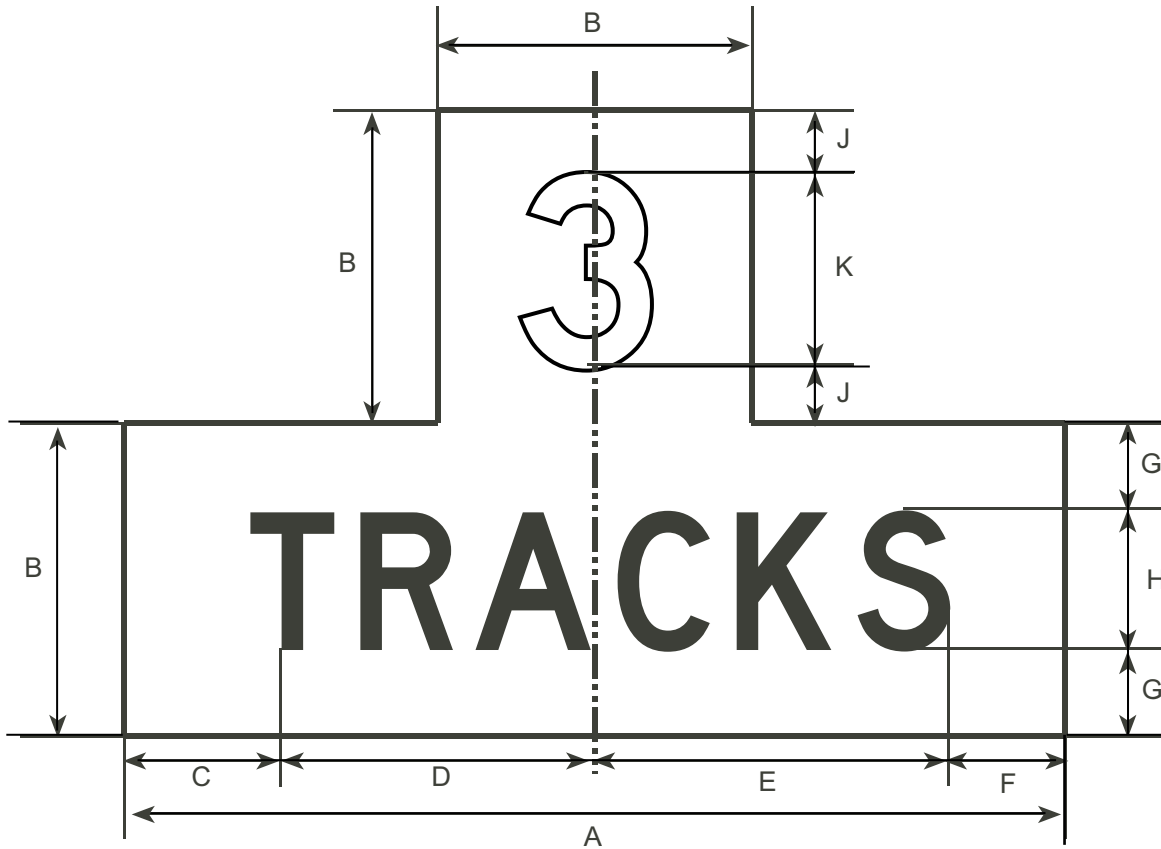

Border and Legend: Black
Background: White

NOTE: A strip of high intensity or brighter retroreflective white material not less than 2 inches in width shall be installed for the full length of the front and back of each support from the crossbuck sign or Number of Tracks (R15-2) to near ground level.

Road Class	Dimensions (inches)									
	A	B	C	D	E	F	G	H	J	K
Conv & Min	27	9	3.5	10	9.88	3.62	2.5	4D	1.75	5.5D

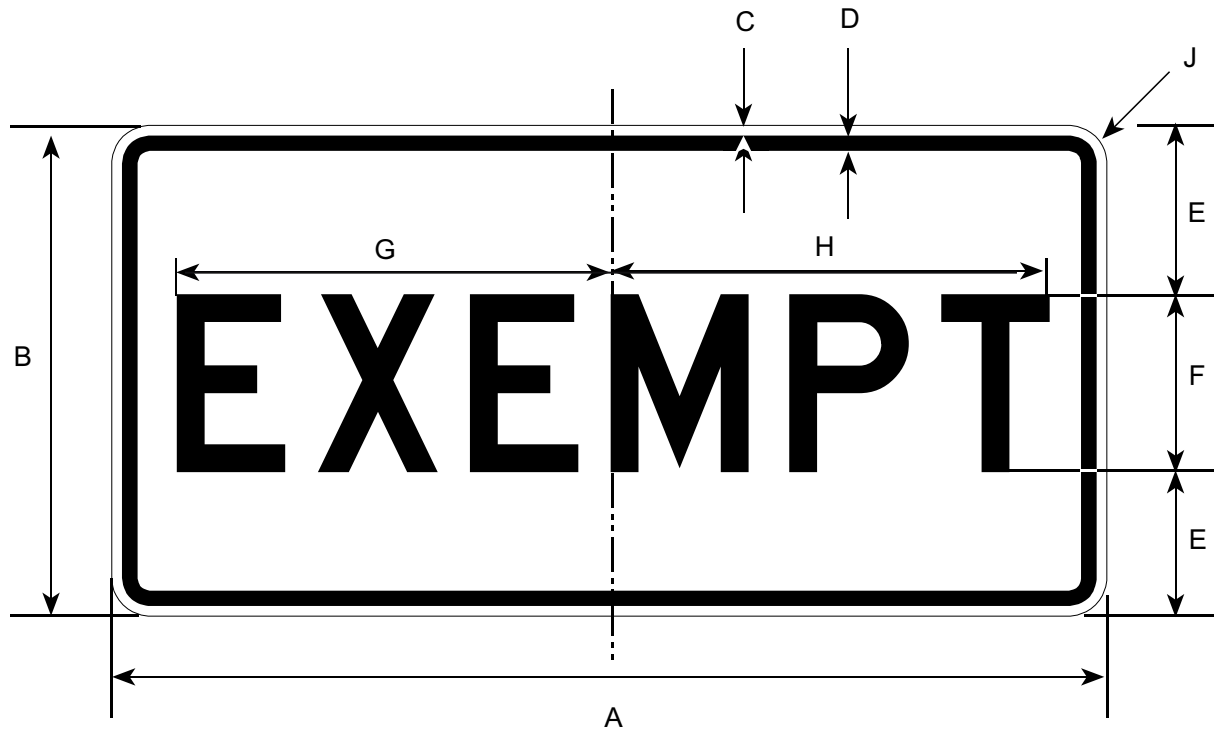

Border and Legend: Black
 Background: White

Road Class	Dimensions (inches)								
	A	B	C	D	E	F	G	H	J
Conv & Min	24	12	0.38	0.63	4	4D	9.75	10	1.5

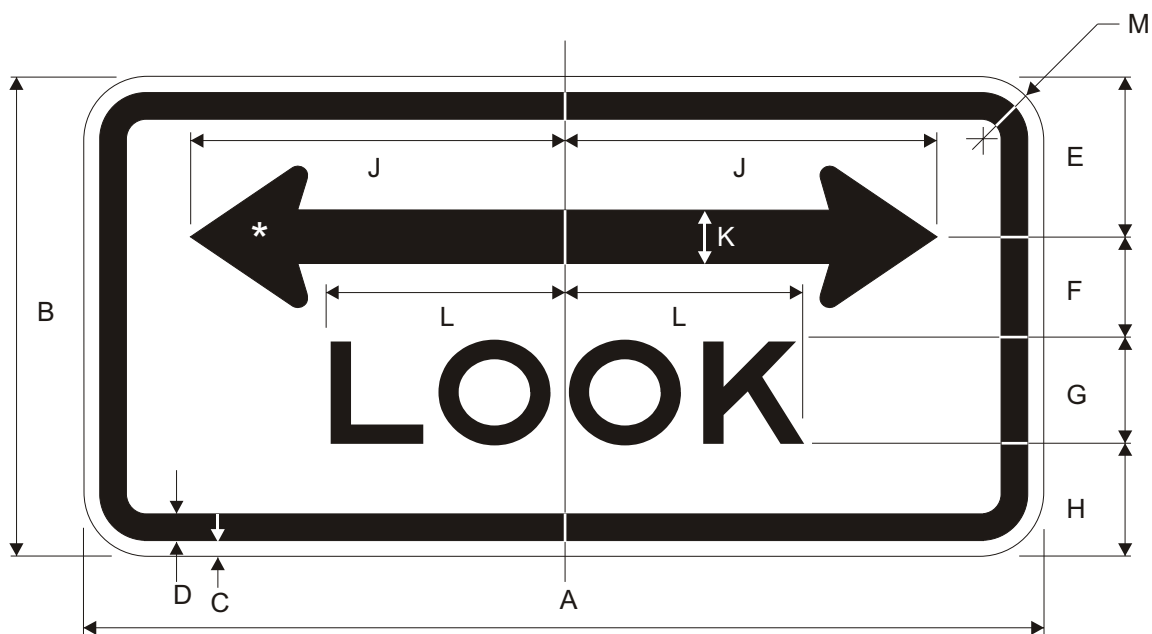

Border and Legend: Black
Background: White

*See Appendix B-1 for Standard Arrow Details.

Road Class	Dimensions (inches)											
	A	B	C	D	E	F	G	H	J	K	L	M
Conventional	36	18	0.63	0.88	6.0	4.0	4F	4.3	14	2.0	8.91	2.25
Expy/Frwy	48	24	0.8	1.25	8.0	5.0	5F	5.8	18	2.5	11.13	3.0

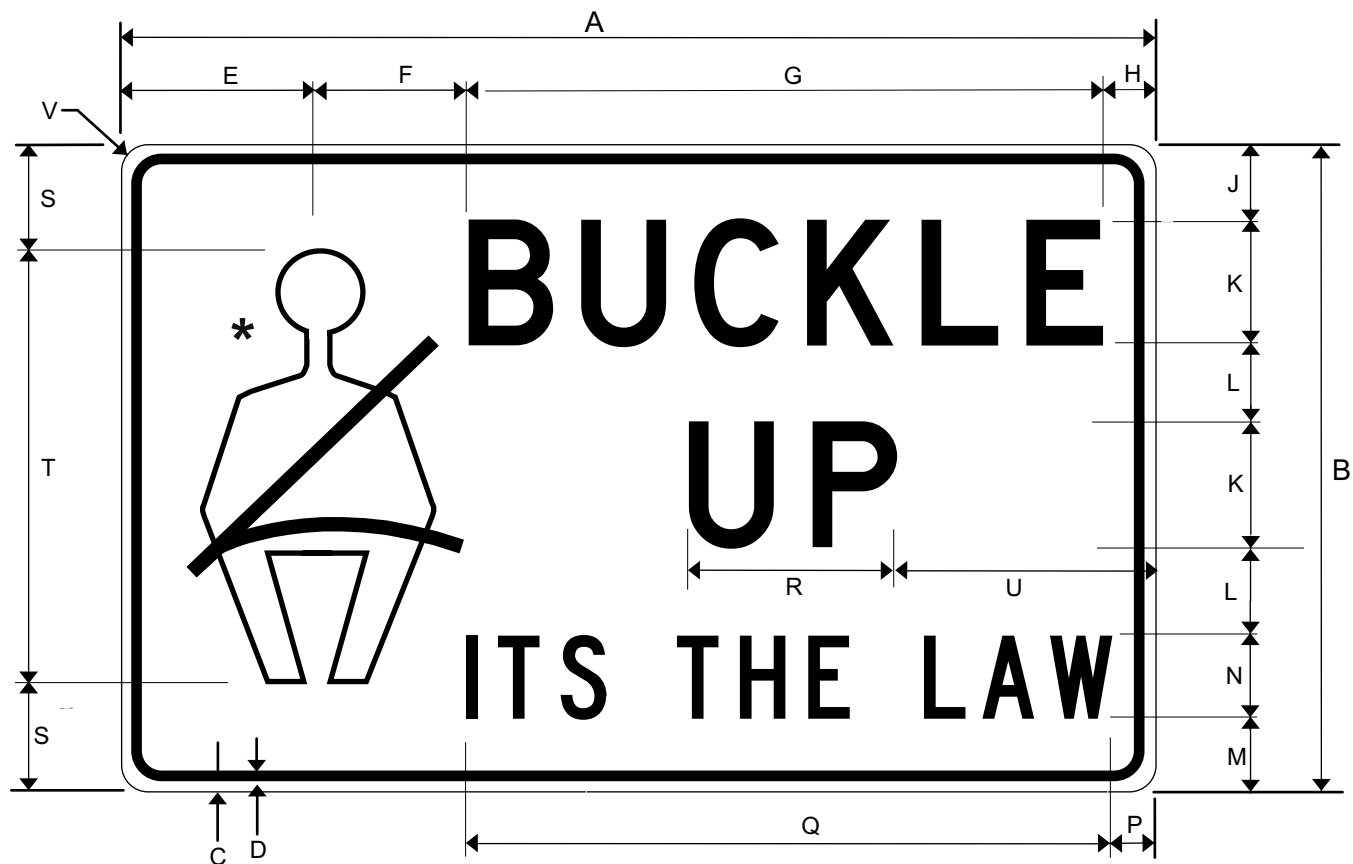

* Make seat belt symbol proportional to the graphic shown.

Border and Legend: Black
Background: White

Road Class	Dimensions (inches)																			
	A	B	C	D	E	F	G	H	J	K	L	M	N	P	Q	R	S	T	U	V
Conv & Mn	48	30	0.38	0.63	9.0	6.75	29.75	2.5	4.5	6D	3.5	2.5	4C	2.5	30.5	9.5	5.38	19.25	12.5	1.5



Border and Legend: Black
 Upper Background: Orange
 Lower Background: White

Prior to the 2002 publication of this manual,
 this sign was numbered AK-CR16-100.

Road Class	Dimensions (inches)											
	A	B	C	D	E	F	G	H	I	J	K	L
Conv & Min	36	48	0.88	0.63	3	4C	1.37	3.25	6E	5D	4.75	2.25

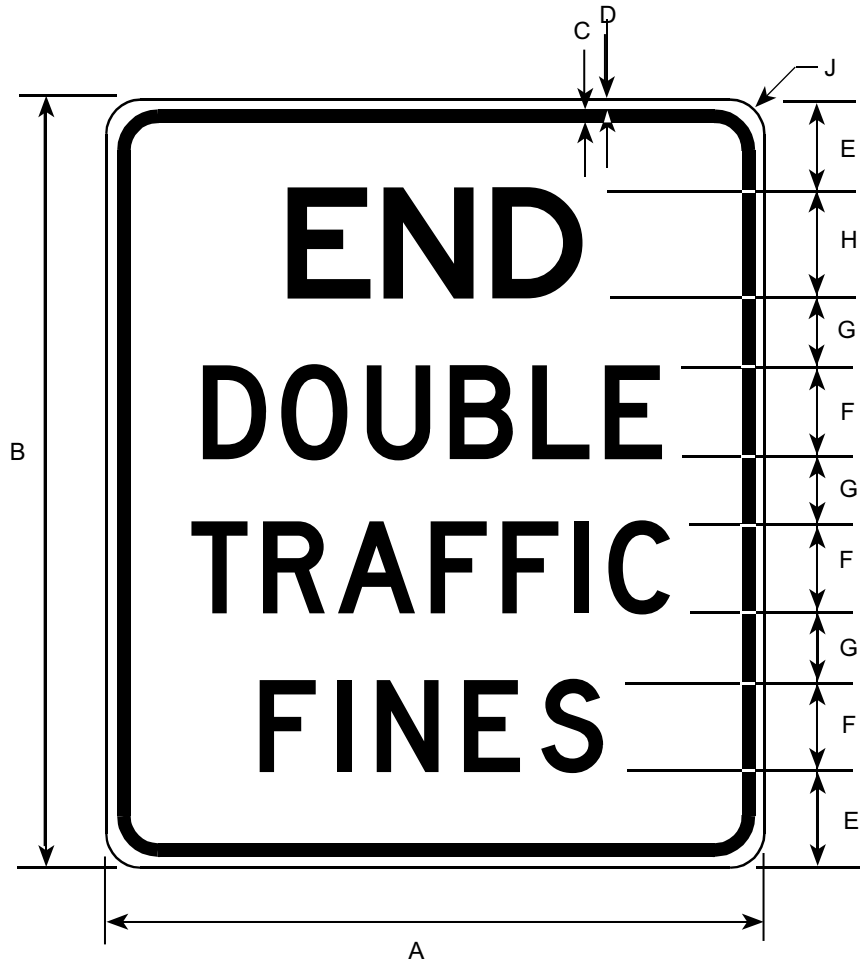

Border and Legend: Black
 Background: White

Prior to the 2002 publication of this manual,
 this sign was numbered AK-CR16-101.

Road Class	Dimensions (inches)								
	A	B	C	D	E	F	G	H	J
Conv & Min	36	42	0.88	0.63	5.25	5D	3.5	6E	2.25

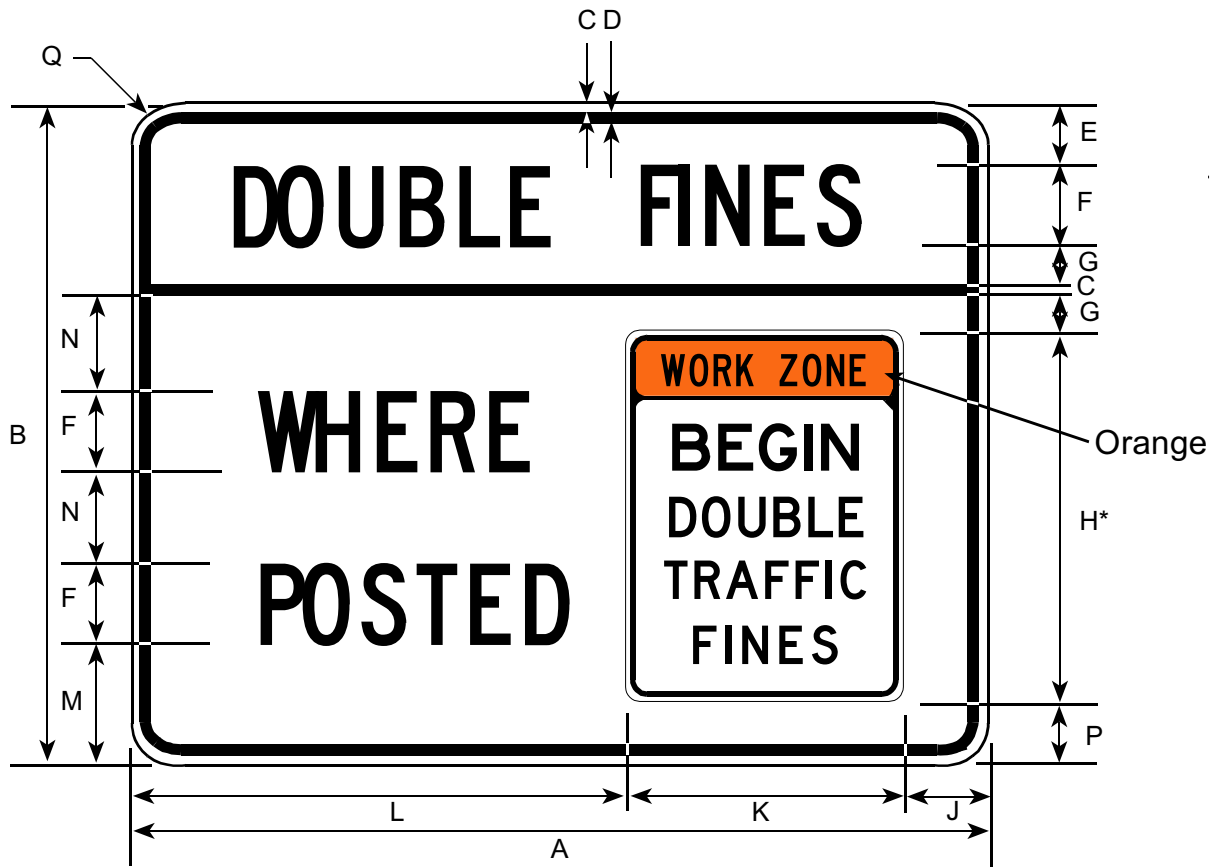

Border and Legend: Black
 Background: White
 "Work Zone" Background: Orange

* "WORK ZONE BEGIN DOUBLE TRAFFIC FINES" insert is 75% of R16-100 dimensions.

Prior to the 2002 publication of this manual, this sign was numbered AK-CR16-102.

Road Class	Dimensions (inches)														
	A	B	C	D	E	F	G	H	J	K	L	M	N	P	Q
Conv & Min	84	66	0.75	1.38	6.25	8C	4.0	36*	8.25	27	48.75	12.24	9.38	7.0	3.0

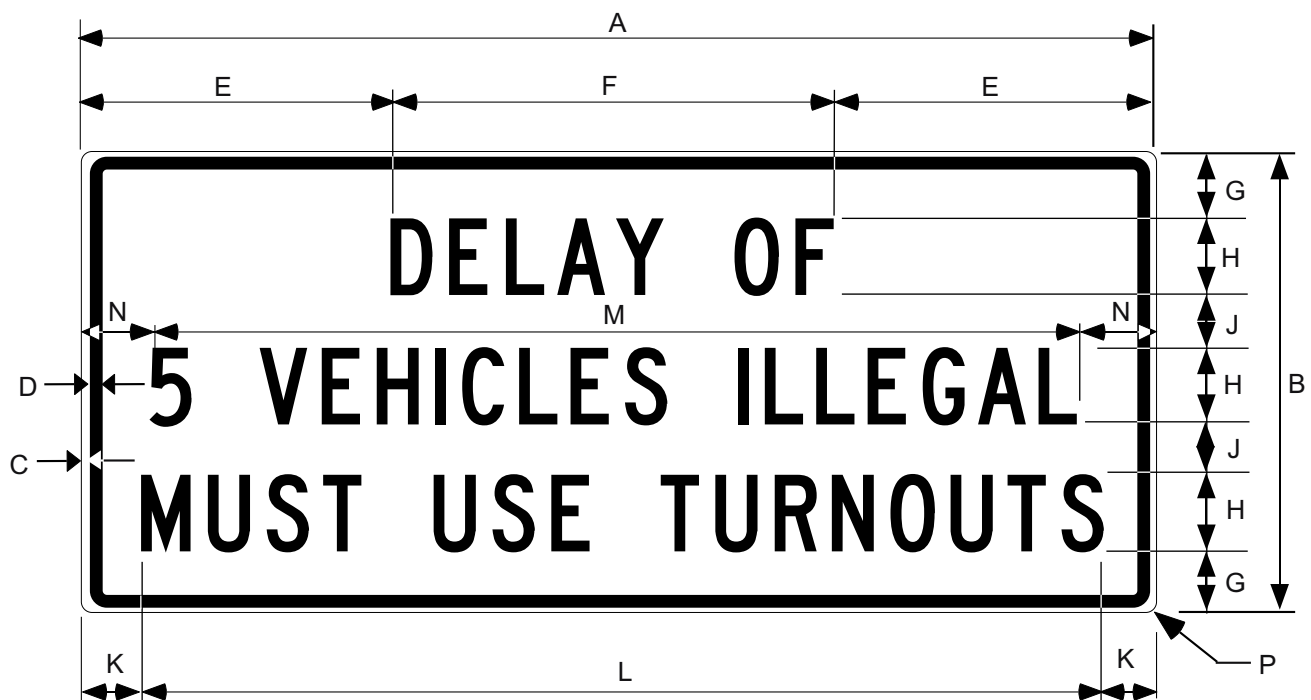

Border and Legend: Black
Background: White

Road Class	Dimensions (inches)													
	A	B	C	D	E	F	G	H	J	K	L	M	N	P
Conventional	84	36	0.75	1.25	24.7	34.6	5.0	6C	4.0	4.50	75	72.4	5.8	4.0

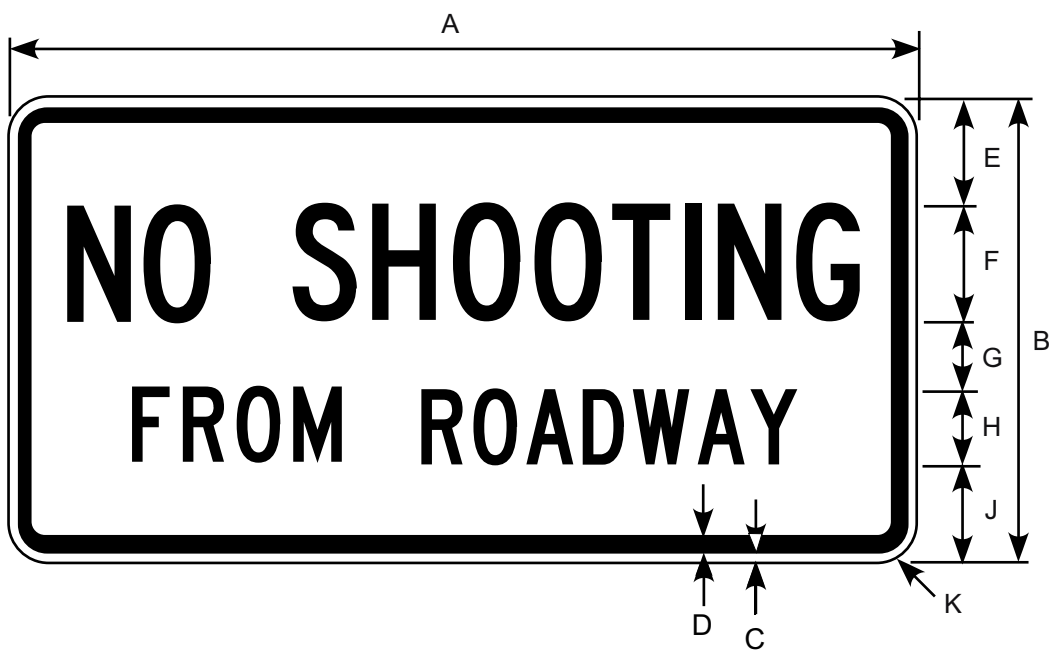

Border and Legend: Black
Background: White

Prior to the 2002 publication of this manual,
this sign was numbered R16-2.

Road Class	Dimensions (inches)									
	A	B	C	D	E	F	G	H	J	K
Conv & Min	48	24	0.63	0.88	5.5	6C	3.5	4C	5	2.25

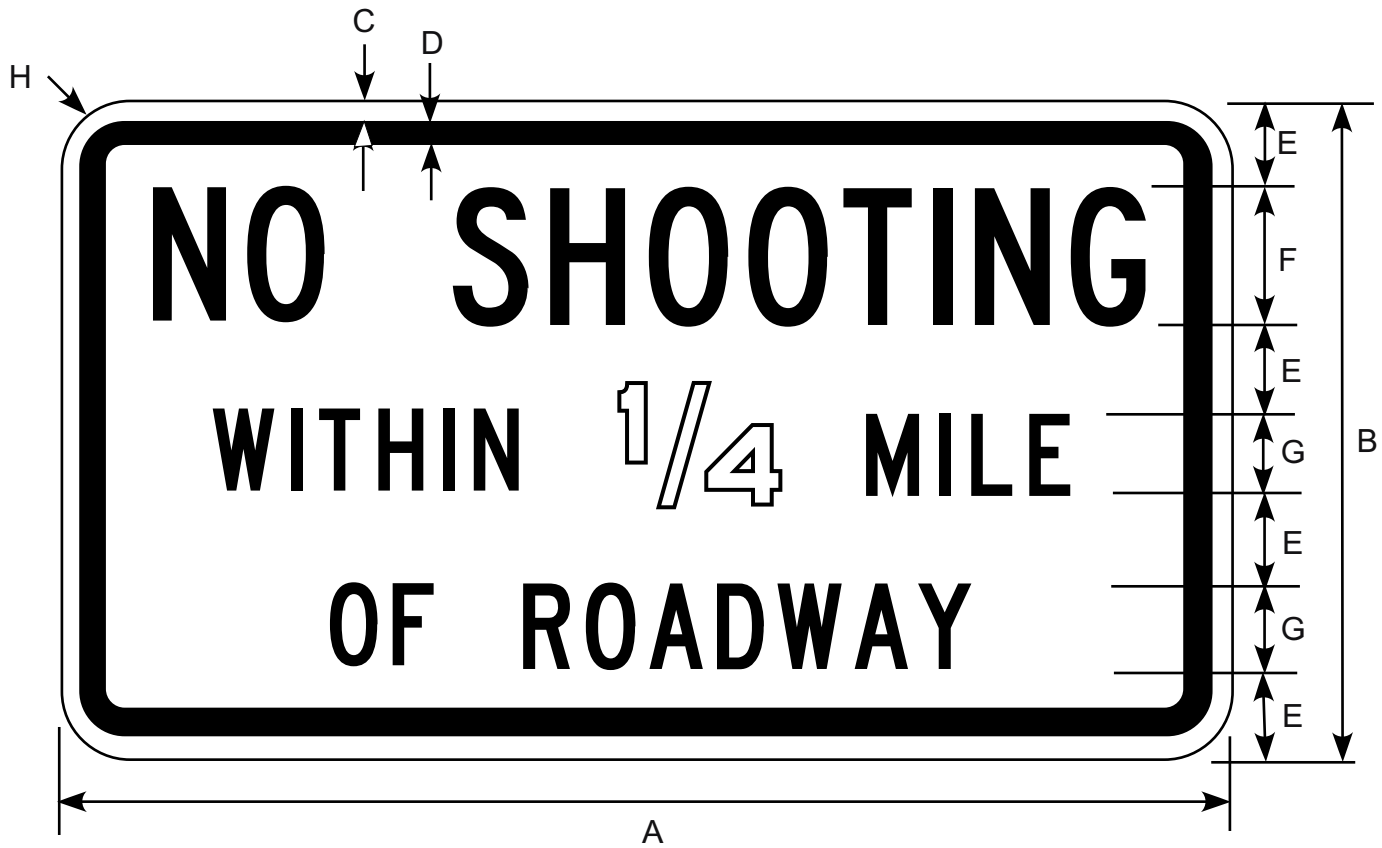

Border and Legend: Black
Background: White

Prior to the 2002 publication of this manual,
this sign was numbered R16-3.

Road Class	Dimensions (inches)							
	A	B	C	D	E	F	G	H
Conv & Min	54	30	0.75	1.25	4	6C	4C	3

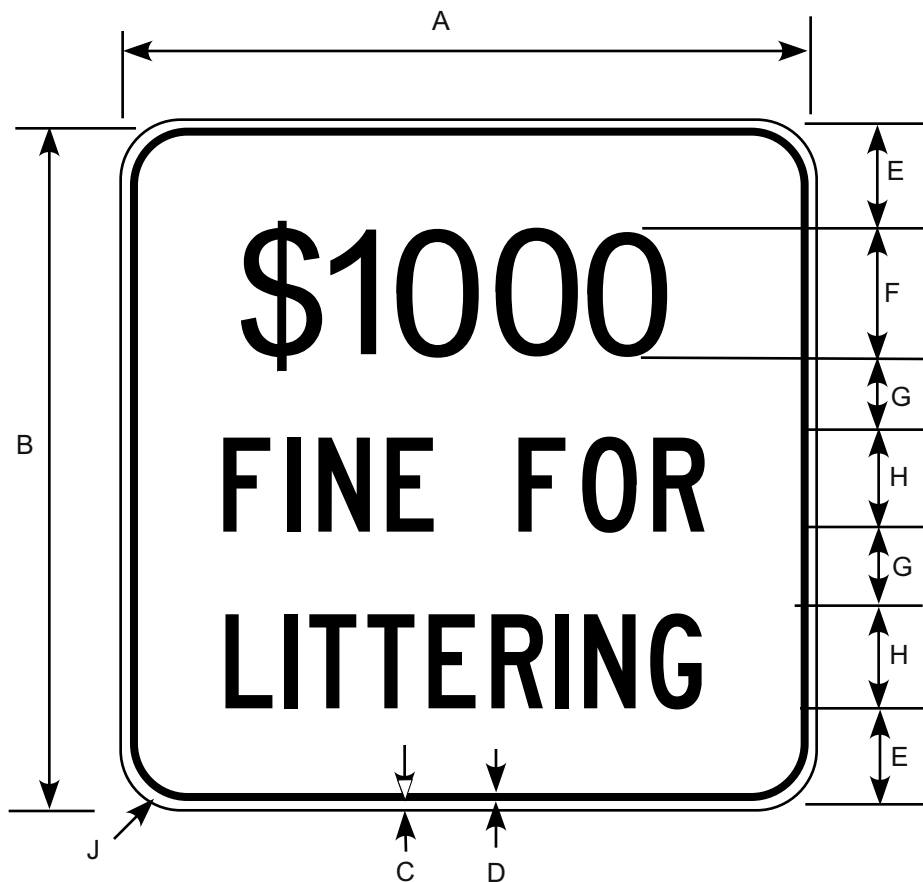

Border and Legend: Black
Background: White

Prior to the 2002 publication of this manual,
this sign was numbered R16-1.

Road Class	Dimensions (inches)								
	A	B	C	D	E	F	G	H	J
Conv & Min	42	42	0.75	1.25	6	8C	5	6C	2.25



Border and Legend: Black
Background: White

Road Class	Dimensions (inches)								
	A	B	C	D	E	F	G	H	J
Conv & Min	24	30	0.38	0.63	5D	4D	2	3	1.5

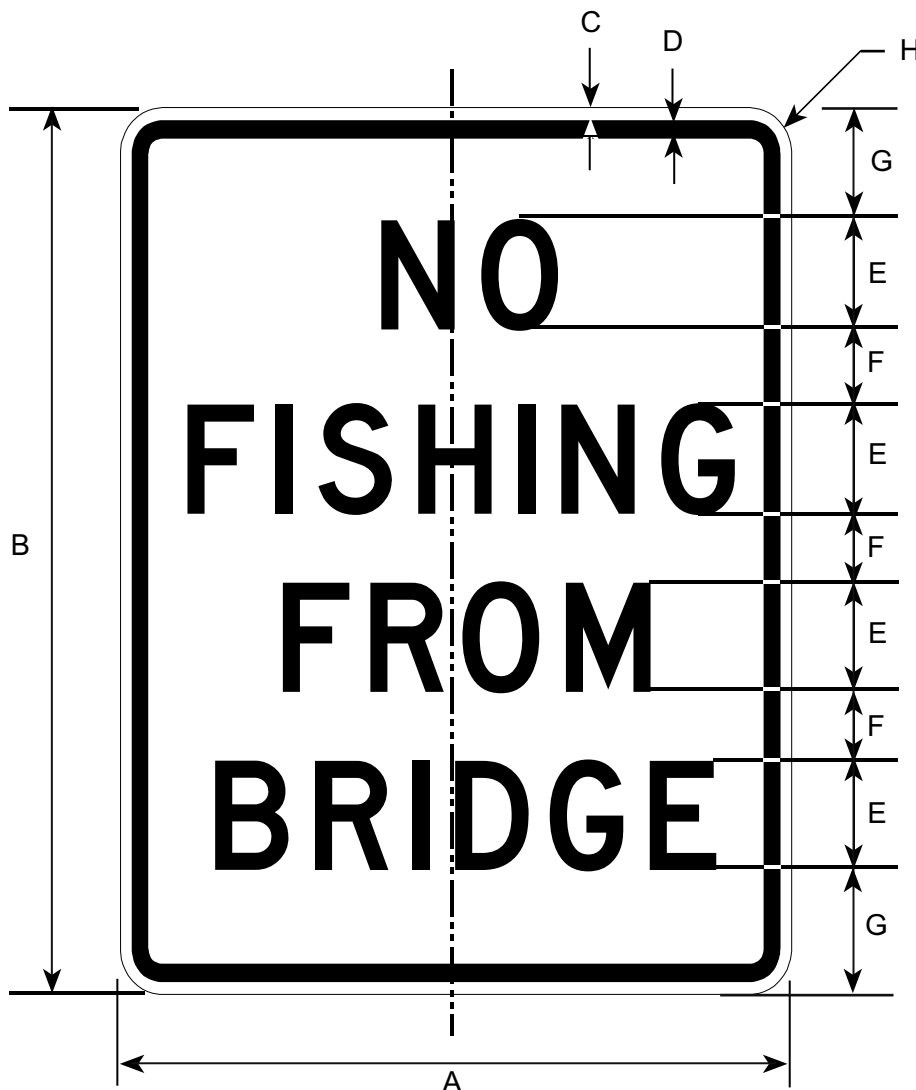

Border and Legend: Black
Background: White

Road Class	Dimensions (inches)							
	A	B	C	D	E	F	G	H
Conv & Min	18	24	0.38	0.63	3D	2	3	1.5

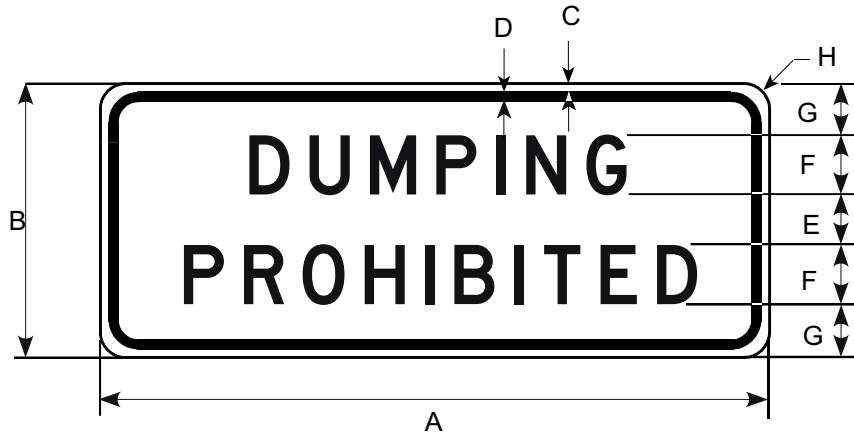

Border and Legend: Black
Background: White

Road Class	Dimensions (inches)							
	A	B	C	D	E	F	G	H
Conv & Min	30	14	0.38	0.5	3	3D	2.5	1.5

R16-110

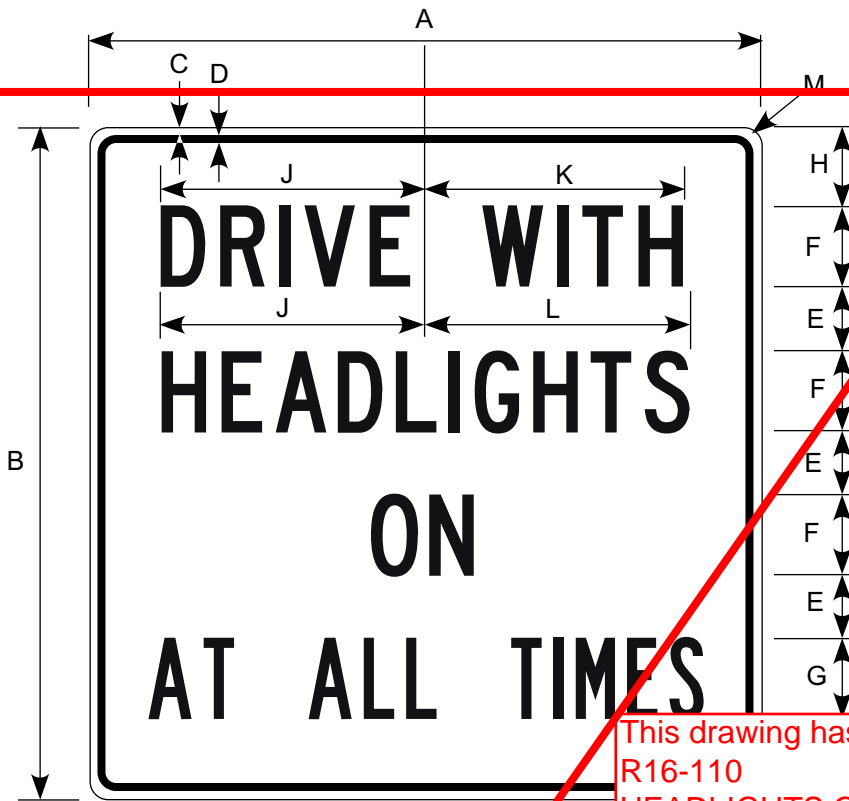

This drawing has been replaced with:
R16-110
HEADLIGHTS ON AT ALL TIMES
 (04/12/10).

Click on the drawing number in the upper right corner to go to the Interim Addenda web page.

Border and Legend: Black
 Background: White

Road Class	Dimensions (inches)											
	A	B	C	D	E	F	G	H	J	K	L	M
Conventional	42	42	0.63	0.88	4	5C	5B	5	16.50	16.25	16.63	2.25

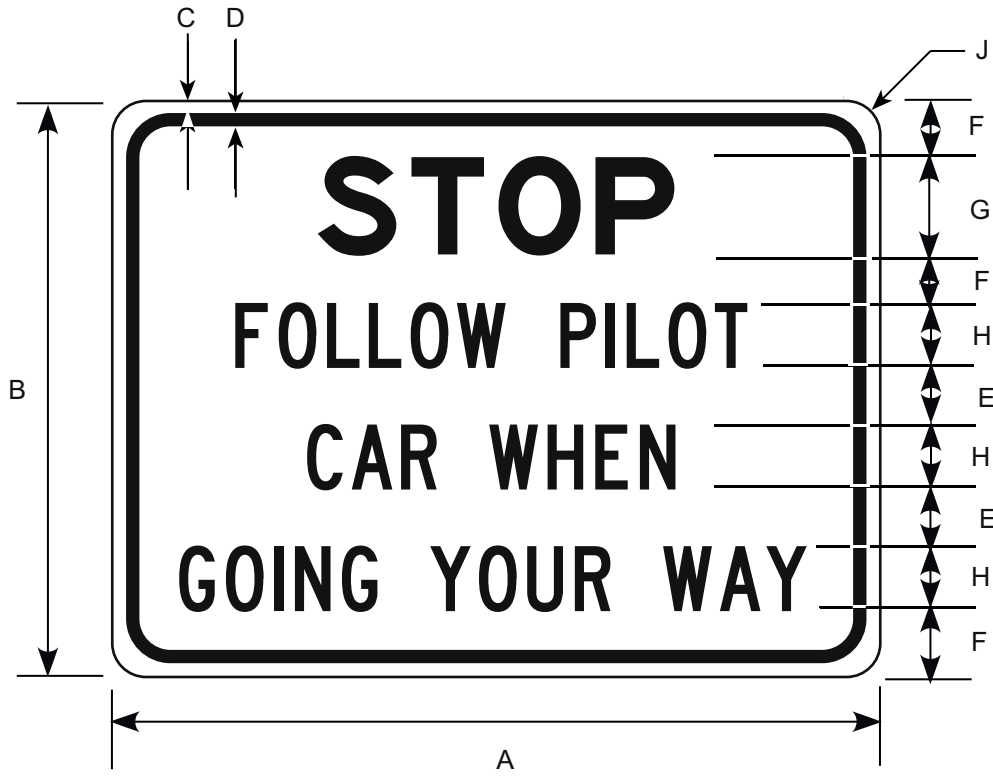

Border and Legend: Black
Background: White

Road Class	Dimensions (inches)								
	A	B	C	D	E	F	G	H	J
All	48	36	0.63	0.88	3	4	6E	4C	2.25

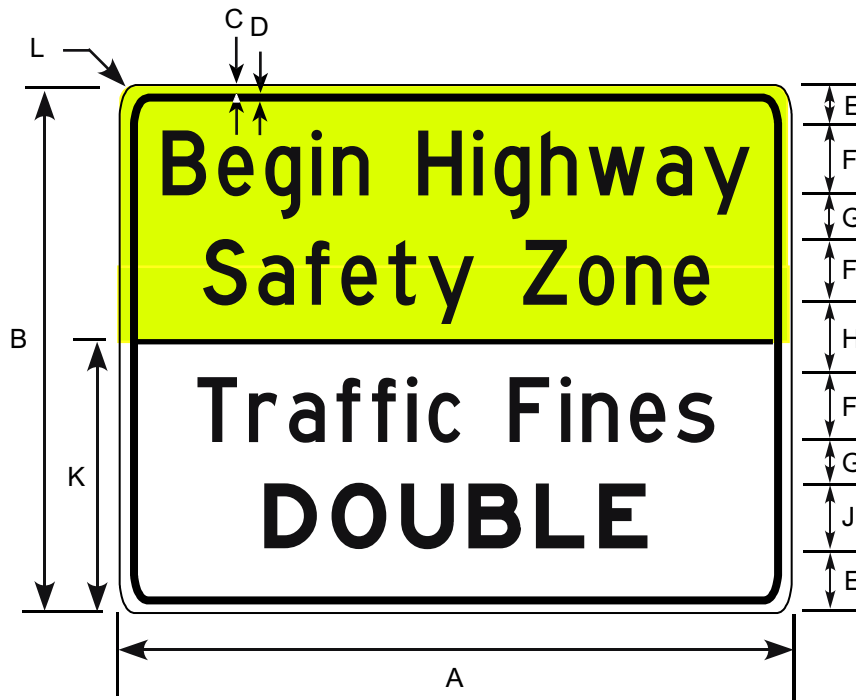

Border and Legend: Black
 Background: White / Fluorescent Yellow-Green

Road Class	Dimensions (inches)										
	A	B	C	D	E	F	G	H	J	K	L
Conventional	84	66	0.75	1.25	7.0	8D	6	8	8E	33	3



Border and Legend: Black
 Upper Background: Fluorescent Yellow-Green
 Lower Background: White

Road Class	Dimensions (inches)											
	A	B	C	D	E	F	G	H	J	K	L	M
Conv & Min	36	48	0.88	0.63	3	4C	1.38	3.25	5D	4.75	6E	2.25

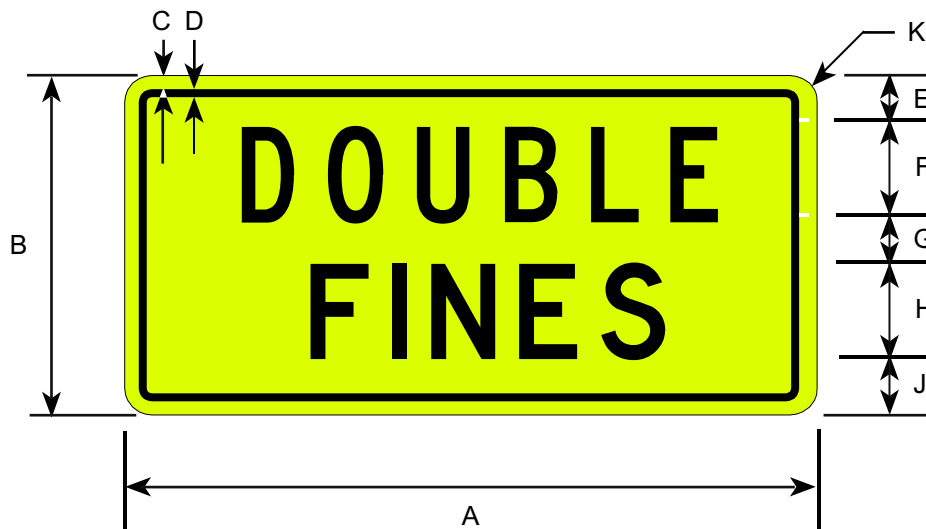

Border and Legend: Black
 Background: Fluorescent Yellow-Green

Road Class	Dimensions (inches)									
	A	B	C	D	E	F	G	H	J	K
Conventional	30	18	0.50	0.75	2.5	5C	2.5	5D	3	1.88



Border and Legend: Black
 Background: White

Road Class	Dimensions (inches)							
	A	B	C	D	E	F	G	H
Conv & Min	72	36	0.75	1.25	6C	5	4	2

SCHOOL SIGNS

S1-1 to S6-1

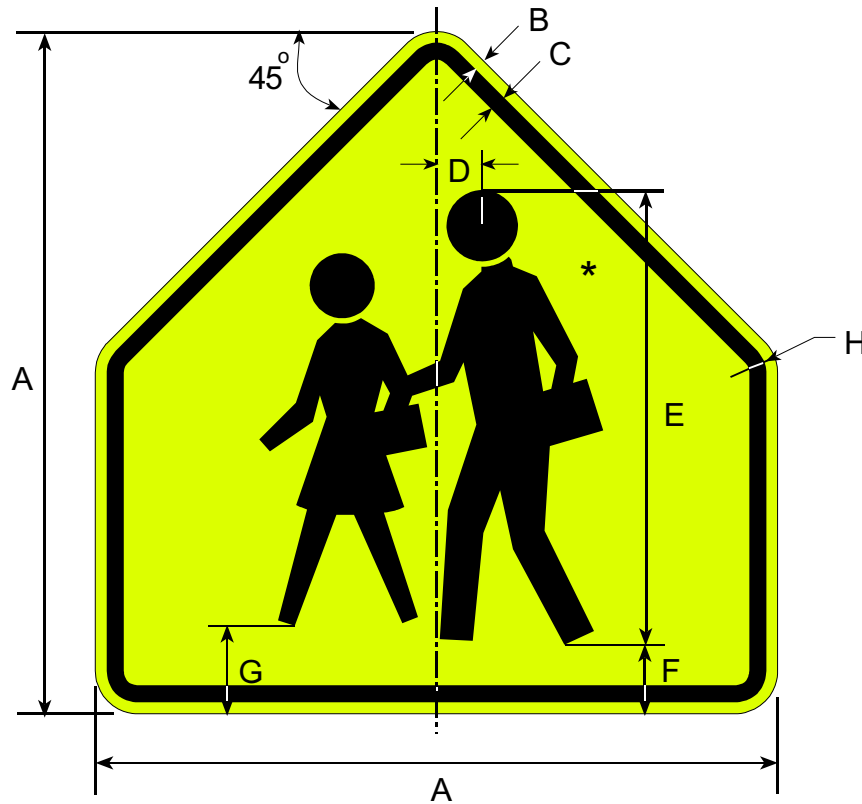

Border and Legend: Black
Background: Fluorescent Yellow-Green

* Make symbol proportional to the one shown.

S1-1s used in advance of a crossing shall be supplemented with W16-9P "AHEAD" or W16-2, "XXX FEET" plates.

S1-1s used at a crossing shall be supplemented with a W16-7P diagonal down-arrow plate.

When a plate is used with S1-1, it shall be the same color as the S1-1.

Road Class	Dimensions (inches)							
	A	B	C	D	E	F	G	H
Minimum	30	0.50	0.75	2.00	20	3.0	3.75	1.88
Conventional	36	0.63	0.88	2.50	24	3.5	4.50	2.25
Expwy/Oversized	48	0.75	1.25	3.25	32	5.0	6.00	3.00

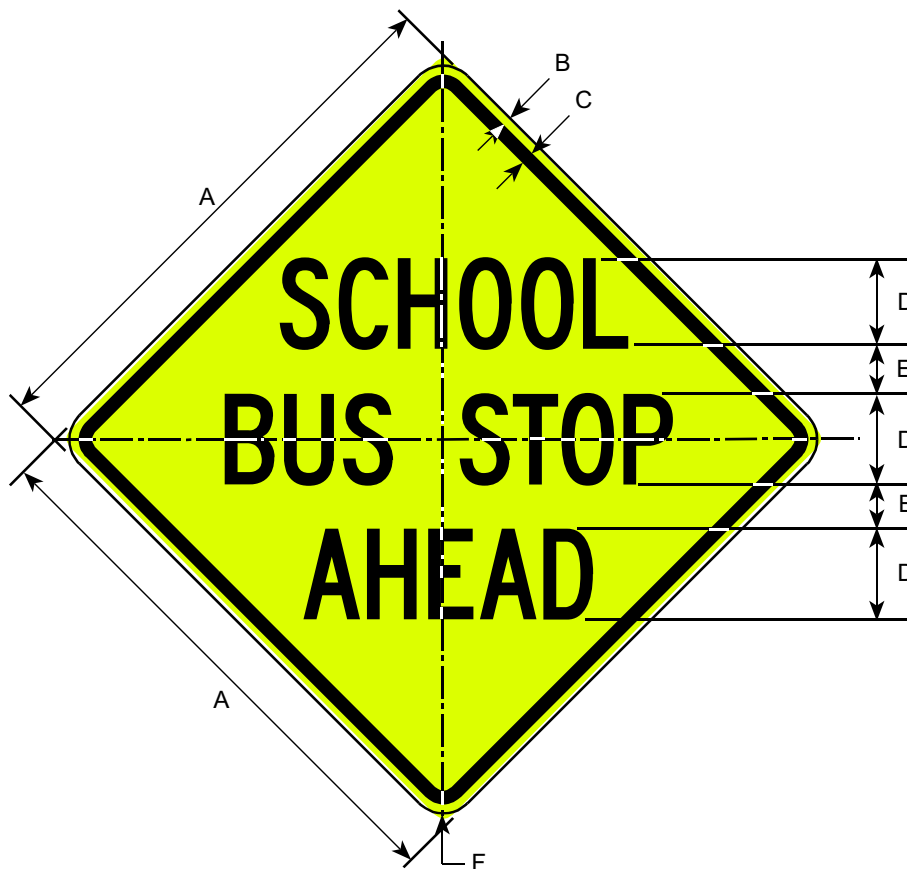

Border and Legend: Black
 Background: Fluorescent Yellow-Green

Road Class	Dimensions (inches)					
	A	B	C	D	E	F
Minimum	30	0.50	0.75	5C	2	1.88
Conventional	36	0.63	0.88	6C	3	2.25
Expw/Oversized	48	0.75	1.25	8C	5	3.00



Border and Legend: Black
 Background: White

Time is variable.

Road Class	Dimensions (inches)							
	A	B	C	D	E	F	G	H
Minimum	30	12	0.38	0.63	2.00	3D	2.0	1.50
Conventional	36	18	0.63	0.88	3.25	5D	1.5	2.25
Epxwy/Oversized	48	24	0.75	1.25	4.75	6D	2.5	3.00

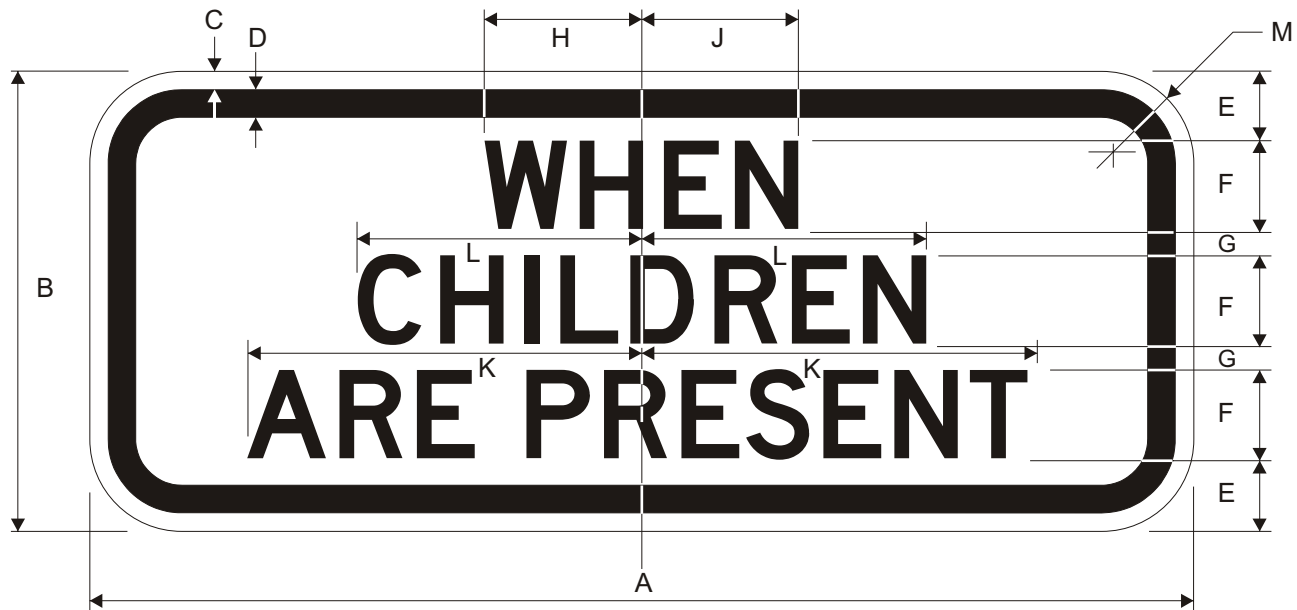

Border and Legend: Black
Background: White

Road Class	Dimensions (inches)											
	A	B	C	D	E	F	G	H	J	K	L	M
Min.	24	10	0.38	0.63	1.5	2D	0.50	3.5	3.31	9.31	6.25	1.5
Conv.	36	18	0.63	0.88	3.0	3D	1.5	5.19	5.13	14	9.38	2.25
Oversized	42	24	0.75	1.25	4.0	4D	2.0	7.0	6.63	18.63	12.5	3.0

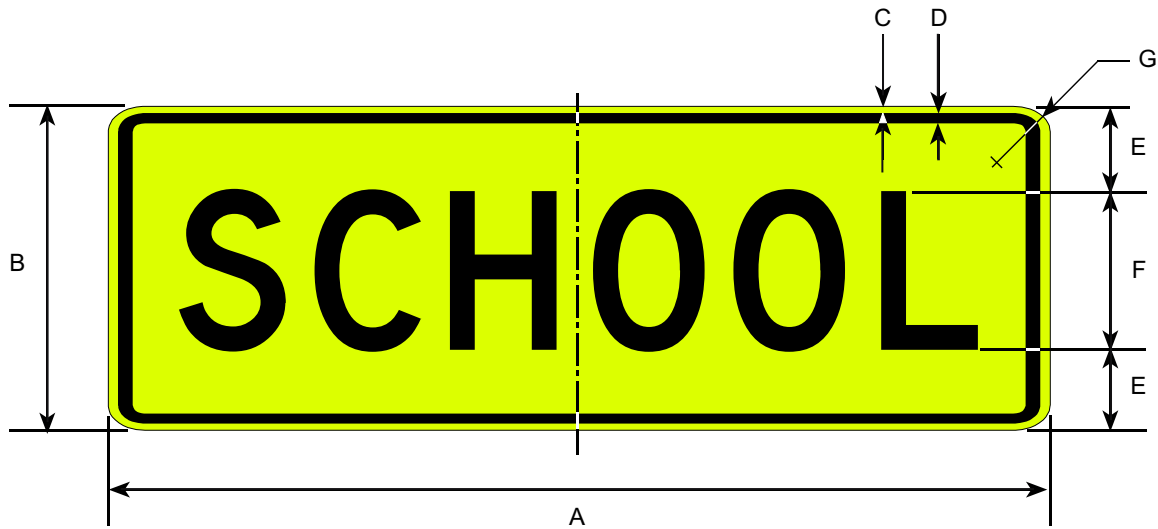

Border and Legend: Black
 Background: Fluorescent Yellow-Green

Road Class	Dimensions (inches)						
	A	B	C	D	E	F	G
Minimum	24	8.0	0.38	0.63	2.0	4D	1.5
Conventional	36	12	0.63	0.88	3.0	6D	2.25
Expwy/Oversized	48	16	0.75	1.25	4.0	8D	3.0

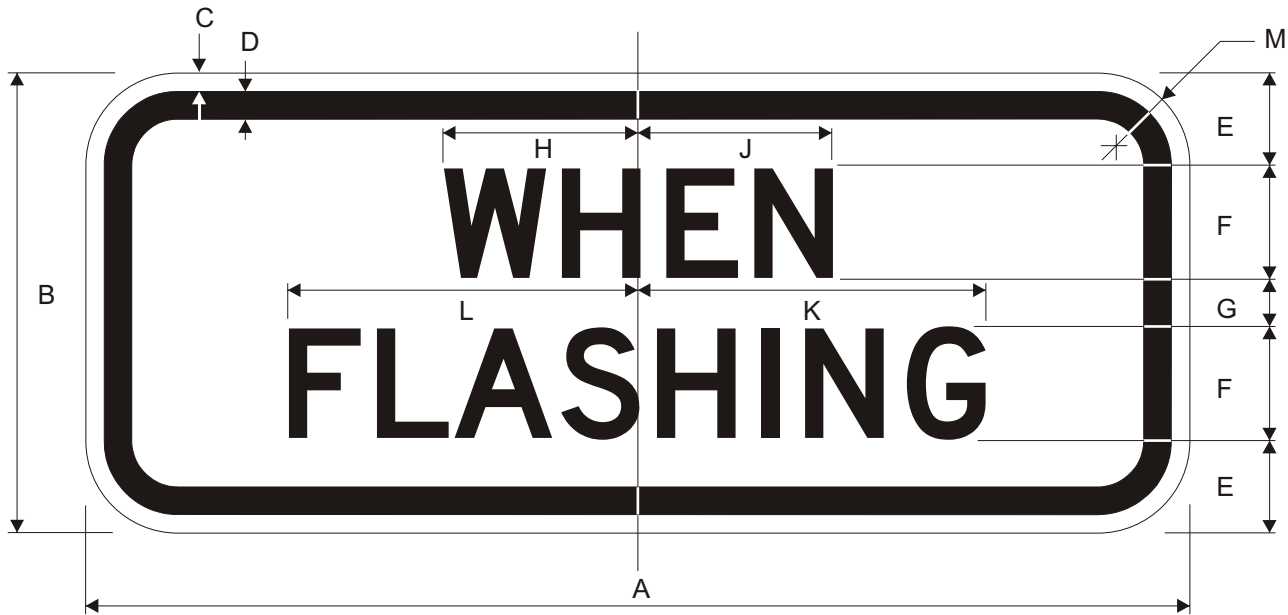

Border and Legend: Black
Background: White

Road Class	Dimensions (inches)											
	A	B	C	D	E	F	G	H	J	K	L	M
Min.	24	10	0.38	0.63	2.0	2.5D	1.0	4.38	4.25	8.06	7.63	1.5
Conv.	36	18	0.63	0.88	3.5	4D	3.0	6.94	6.81	12.94	12.19	2.25
Oversized	42	24	0.75	1.25	5.0	5D	4.0	8.75	8.5	16.13	15.25	3.0

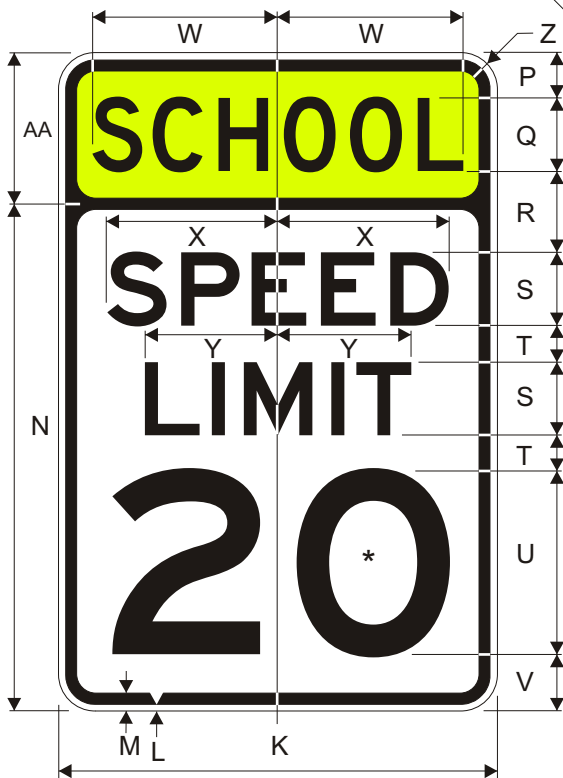
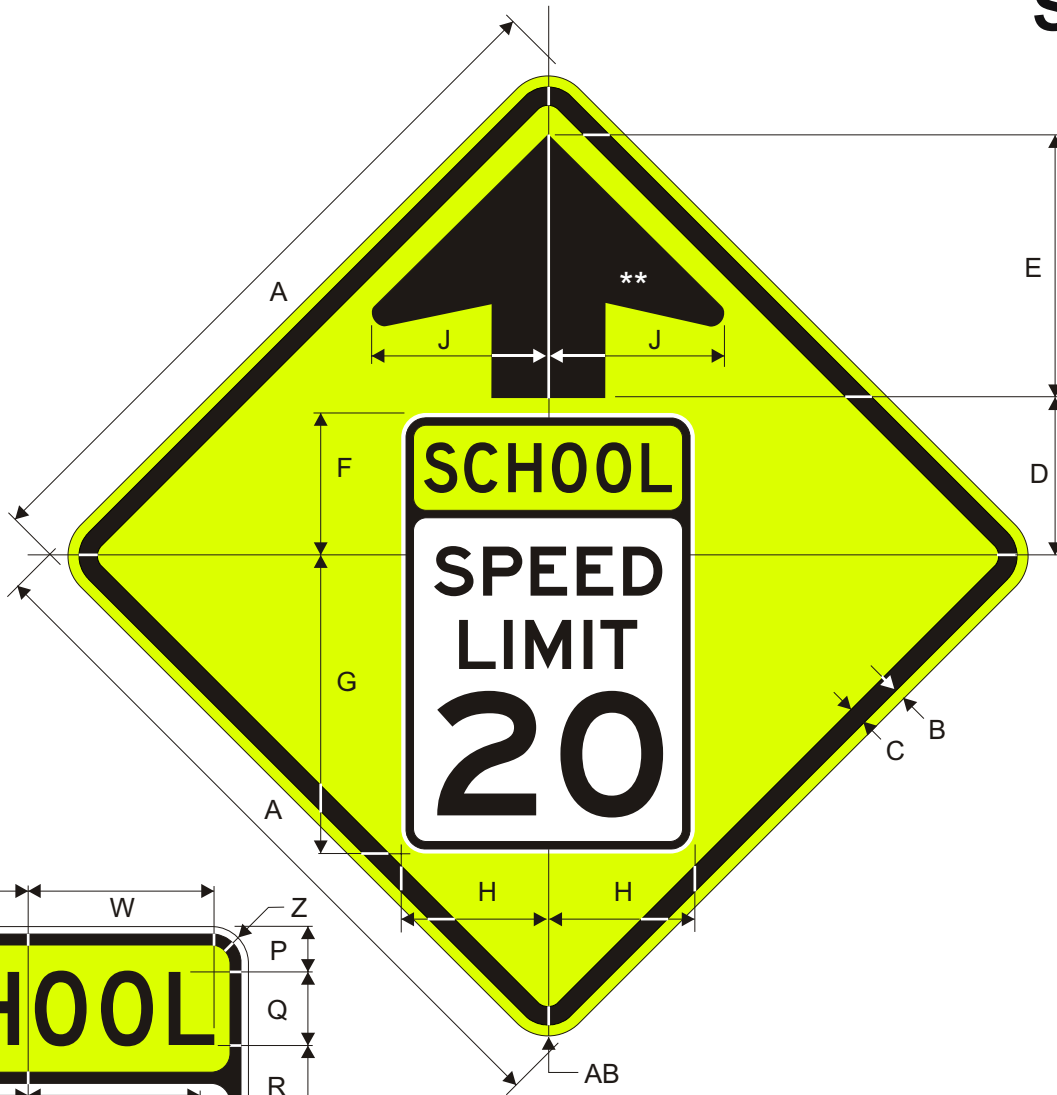

Border and Legend: Black
Background: Fluorescent Yellow-Green

*Optically center numerals about centerline.
**See Appendix B-3 for Standard Arrow Details.

Road Class	Dimensions (inches)							
	A	B	C	D	E	F	G	H
Conv.	36	0.63	0.88	8.25	13.5	7.5	15	7.5
Expy.	48	0.75	1.25	11	18	10	20	10

J	K	L	M	N	P	Q	R	S
9.0	15	0.25	0.38	17.33	1.5	2.5D	2.75	2.5E
12	20	0.30	0.50	23.1	2.0	3.3D	3.7	3.3E

T	U	V	W	X	Y	Z	AA	AB
1.25	6.25	2.0	6.34	5.83	4.55	1.25	5.18	2.25
1.63	8.3E	2.85	8.45	7.78	6.07	1.6	6.9	3.0

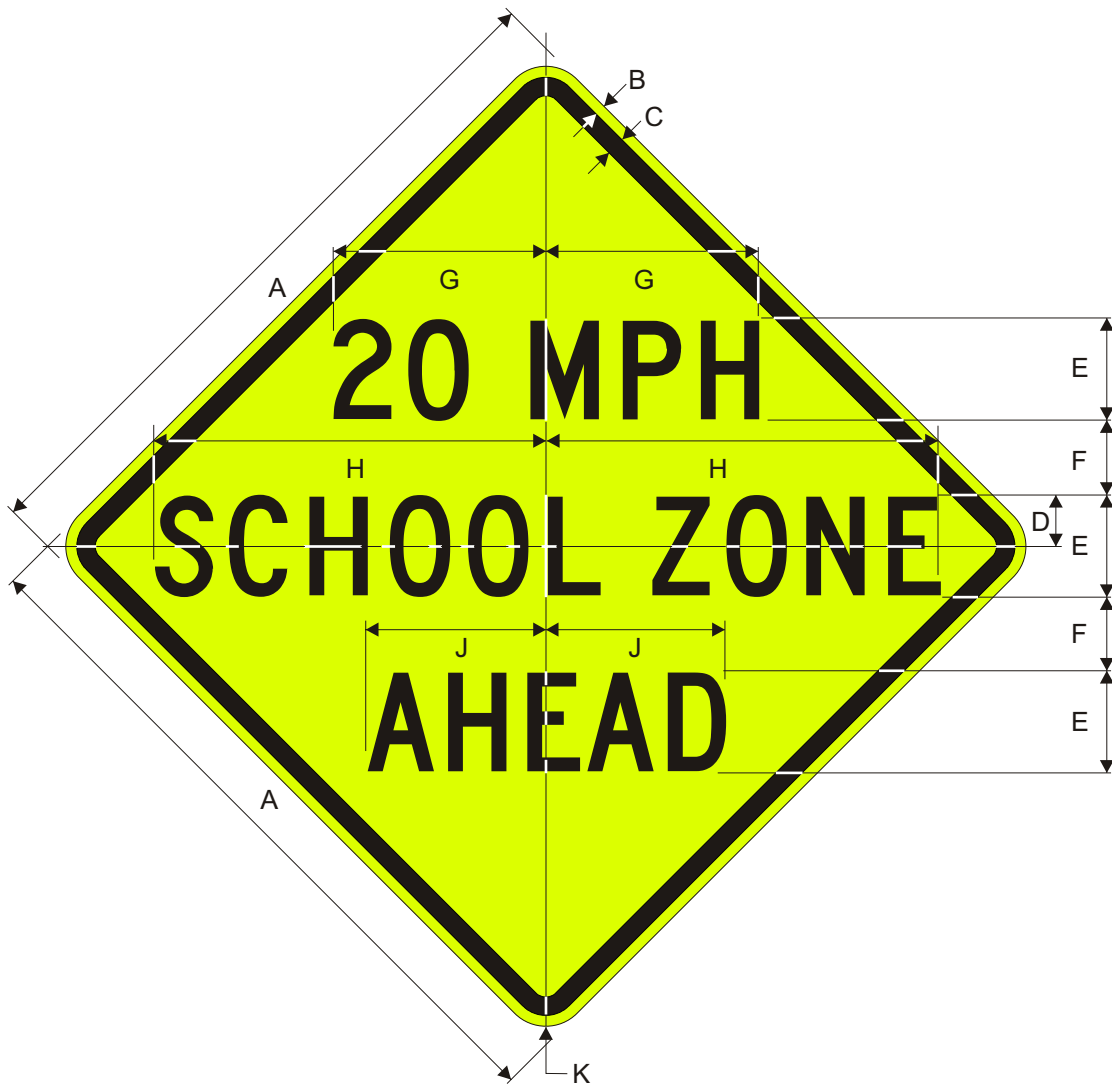

Border and Legend: Black
 Background: Fluorescent Yellow-Green

Road Class	Dimensions (inches)									
	A	B	C	D	E	F	G	H	J	K
Minimum	30	0.5	0.75	2.0	4C	3.5	8.25	15.27	6.97	1.88
Conv.	36	0.63	0.88	2.5	5C	3.5	10.32	19.09	8.71	2.3
Oversized	48	0.75	1.25	3.5	7C	5.0	14.44	26.73	12	3.0

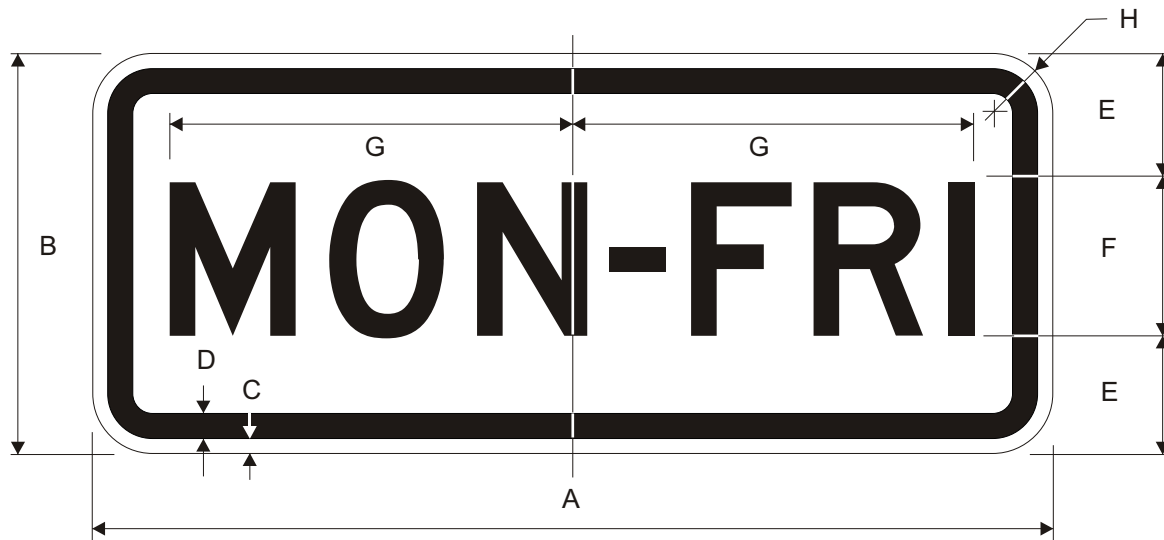

Border and Legend: Black
Background: White

Road Class	Dimensions (inches)							
	A	B	C	D	E	F	G	H
Min/Conv	24	10	0.38	0.63	3.0	4D	10	1.5
Oversized	36	18	0.63	0.88	6.0	6D	15	2.25

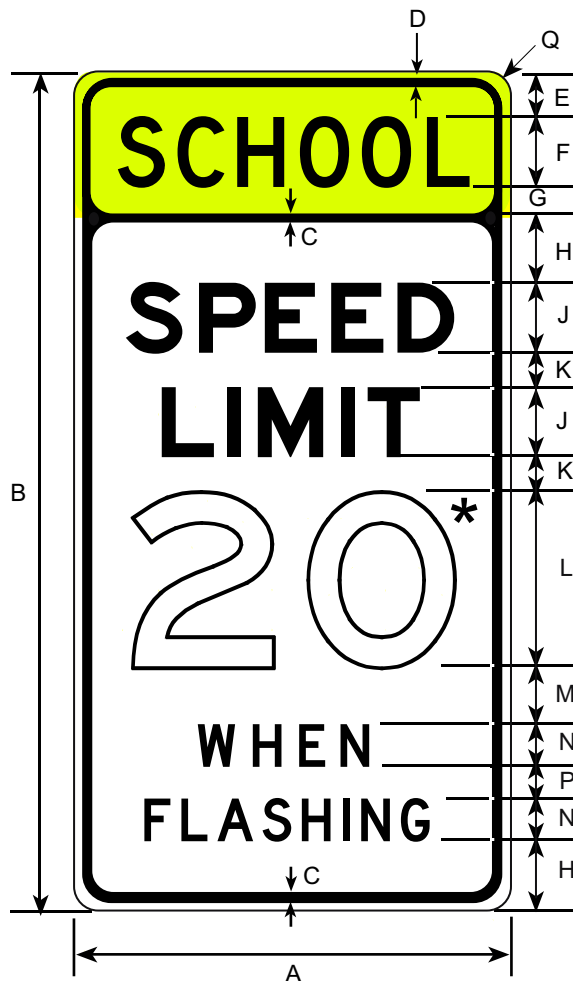

* Optically space numerals about vertical center line.

Border and Legend: Black
 Upper Background: Fluorescent Yellow-Green
 Lower Background: White

Speed limit is variable.

Road Class	Dimensions (inches)									
	A	B	C	D	E	F	G	H	J	K
Minimum	24	48	0.38	0.63	2.5	4D	1.5	4.0	4E	2.0
Conventional	36	72	0.63	0.88	3.75	6D	2.25	6.0	6E	4.0
Oversized	48	96	0.75	1.25	5.0	8D	3.0	8.0	8E	6.0
	L	M	N	P	Q					
	10E	3.0	2.5D	2.0	1.5					
	14E	4.0	4D	2.0	2.25					
	16E	6.0	5D	4.0	3.0					

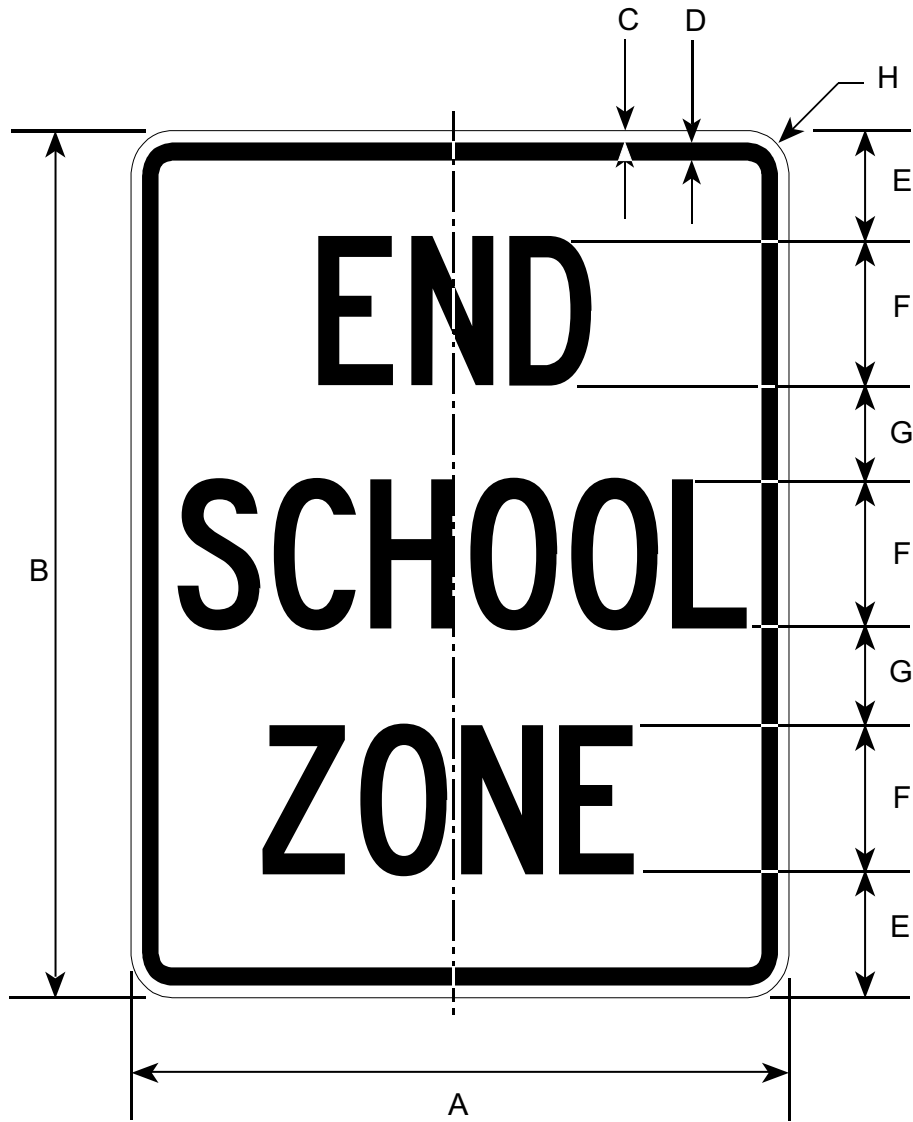

Border and Legend: Black
Background: White

Road Class	Dimensions (inches)							
	A	B	C	D	E	F	G	H
Minimum	18	24	0.38	0.63	3.5	4C	2.5	1.50
Conventional	24	30	0.38	0.63	4.0	5C	3.5	1.50
Oversized	36	48	0.63	0.88	6.5	8C	5.5	2.25

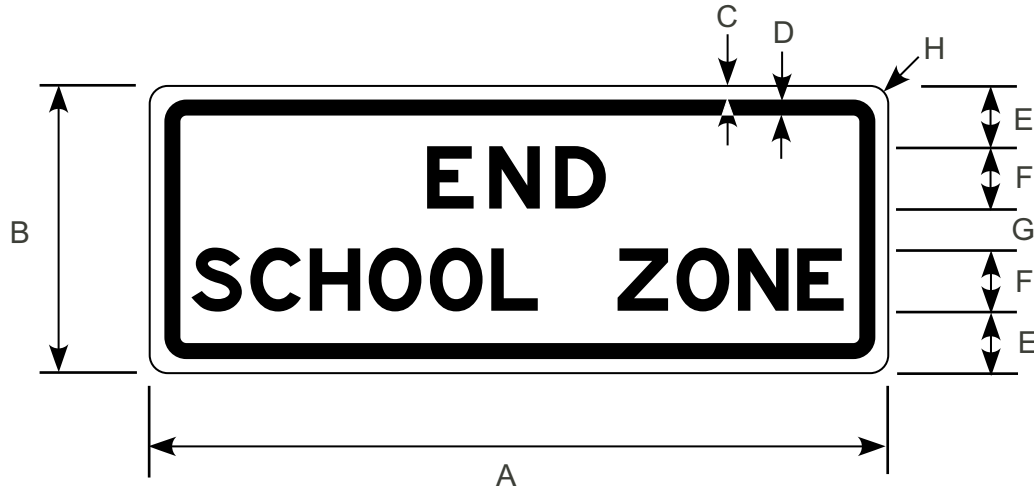

Prior to 2002 publication of this manual, this sign was numbered S6-1.

Border and Legend: Black
Background: White

Road Class	Dimensions (inches)							
	A	B	C	D	E	F	G	H
Minimum	24	10	0.38	0.63	2.25	2E	1.5	1.50
Conventional	30	12	0.50	0.75	2.75	2E	2.5	1.88
Expwy/Oversized	36	14	0.63	0.88	3.00	3E	2.0	2.25

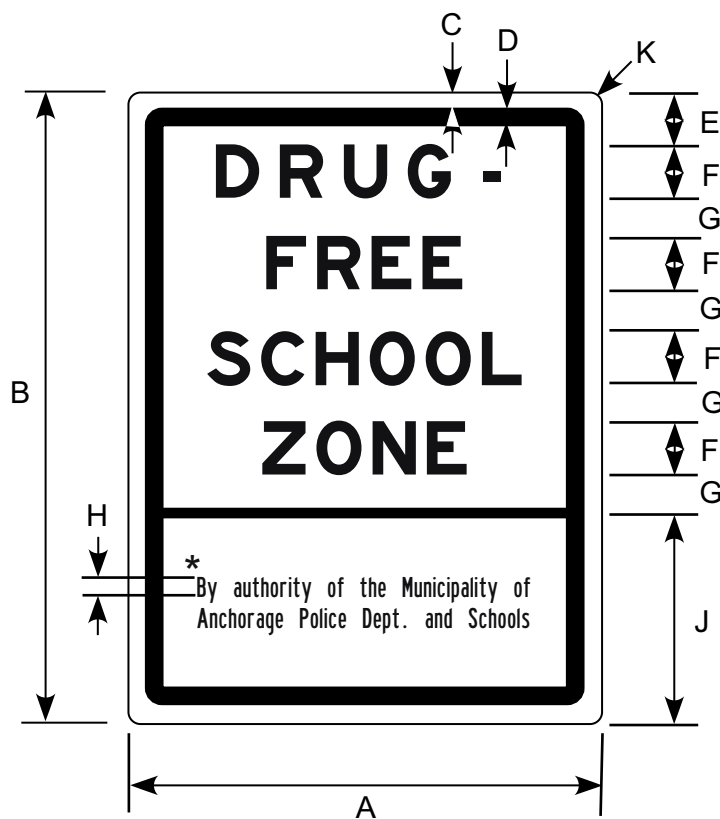

Border and Legend: Black
Background: White

* Legend is variable.

Road Class	Dimensions (inches)									
	A	B	C	D	E	F	G	H	J	K
Conventional	18	24	0.5	0.75	2	2E	1.5	.75B	8	1.5

WARNING SIGNS

W1-1 to W25-2

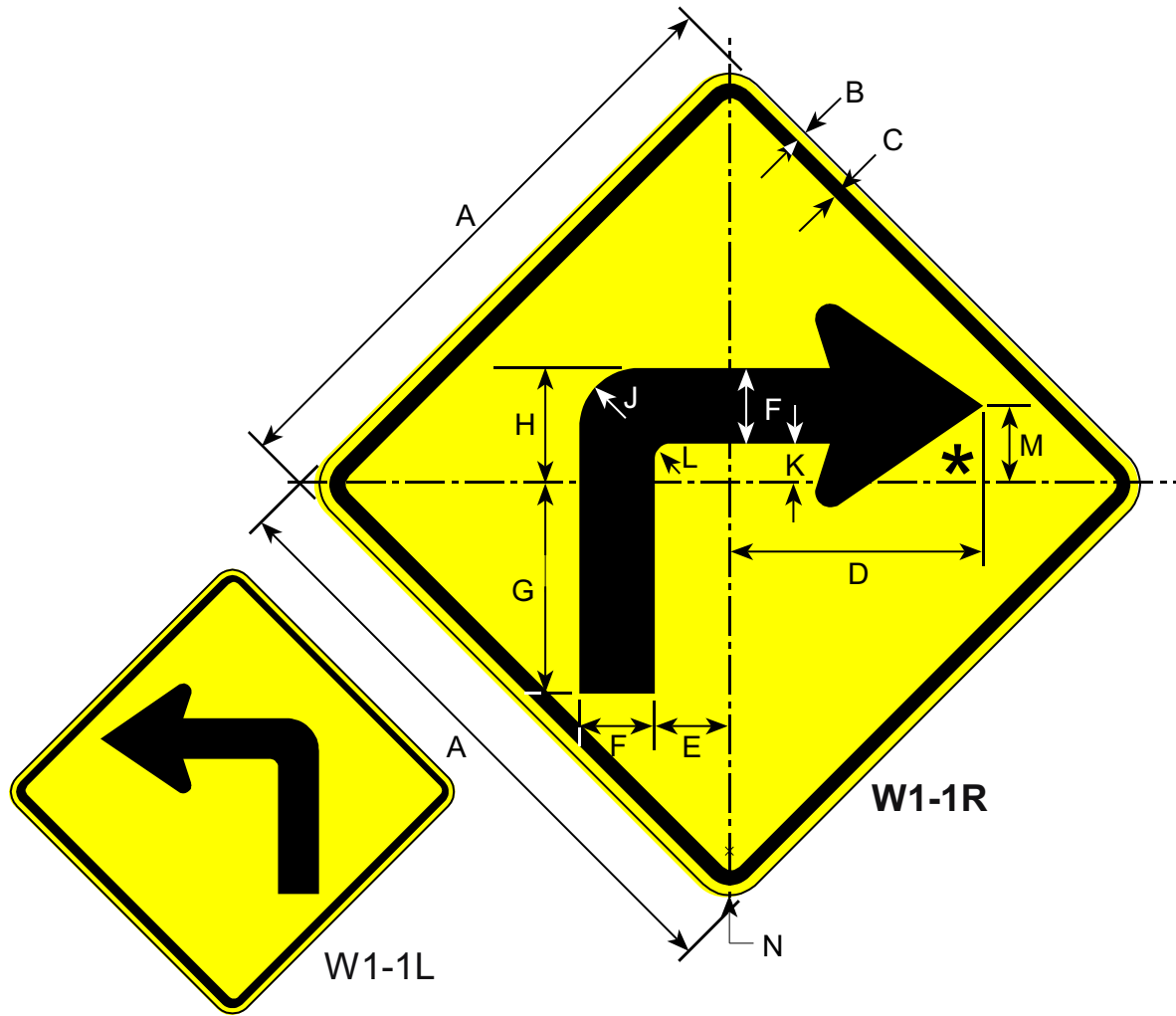

Border and Legend: Black
Background: Yellow

* See Appendix B-1 for Standard Arrow Details.

Road Class	Dimensions (inches)												
	A	B	C	D	E	F	G	H	J	K	L	M	N
Bike	18	0.38	0.63	7.25	2.25	2.63	5.88	3.75	1.88	1.0	0.63	2.5	1.5
Minimum	30	0.50	0.75	12	3.75	4.38	9.0	6.25	3.0	1.88	1.0	4.06	1.88
Conventional	36	0.63	0.88	14.38	4.5	5.25	11	7.5	3.63	2.25	1.25	4.88	2.25
Expwy/Fwy	48	0.75	1.25	19.19	6.0	7.0	15.5	10	4.88	3.0	1.63	6.5	3.0

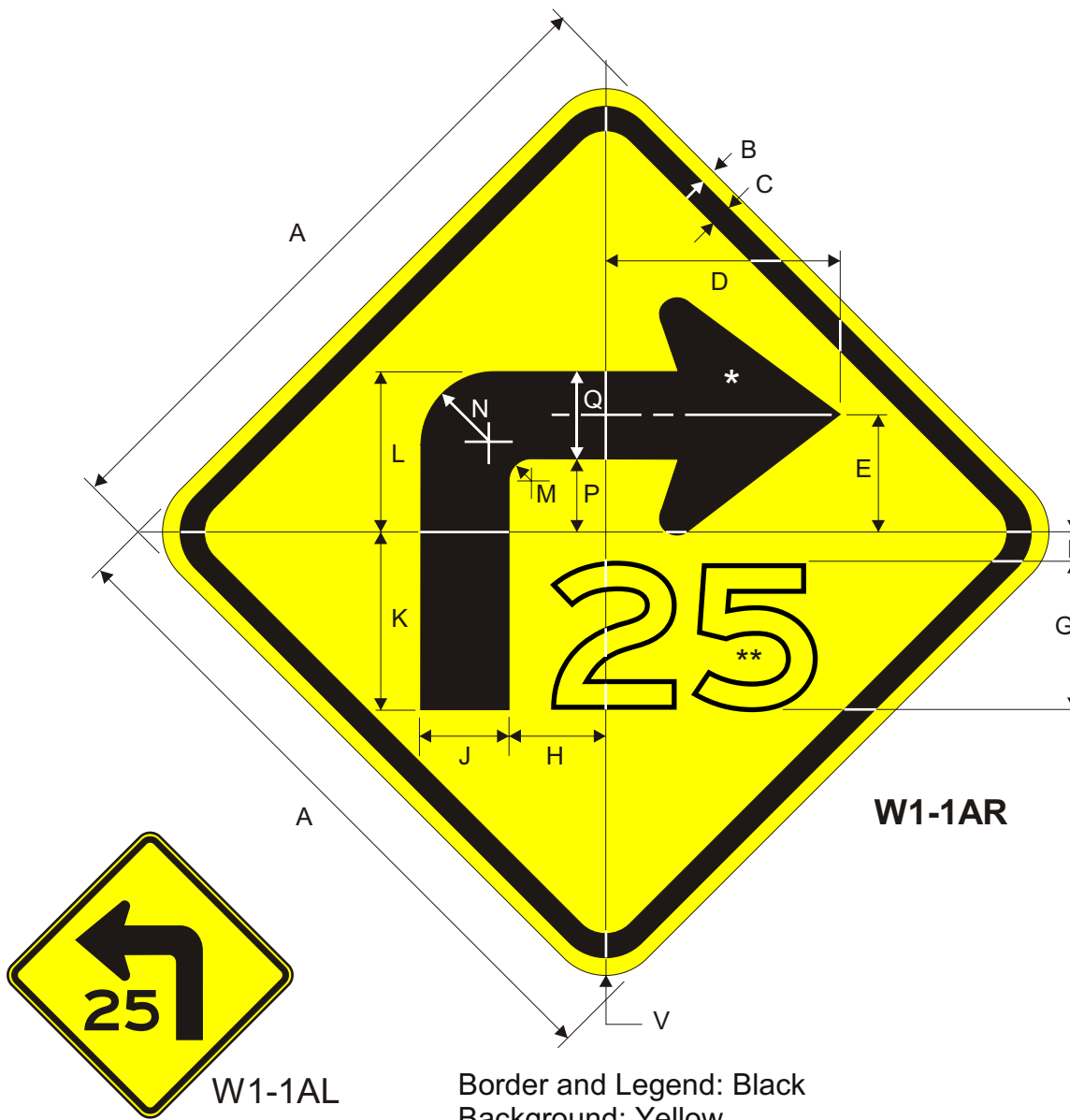

W1-1AR

W1-1AL

Border and Legend: Black
Background: Yellow

* See Appendix B-1 for Standard Arrow Details.

**Optically locate numerals.

Road Class	Dimensions (inches)										
	A	B	C	D	E	F	G	H	J	K	L
Minimum	30	0.50	0.75	10.65	5.25	2.0	6E	4.36	4.0	8.0	7.28
Conventional	36	0.63	0.88	13.33	6.65	2.92	7E	5.44	5.0	9.93	9.12
Expy/Fwy	48	0.75	1.25	18.65	9.33	5.04	9E	7.61	7.0	14.05	12.84

N	P	Q	R
3.2	3.28	4.0	1.88
4.0	4.12	5.0	2.25

W1-2 W1-2A

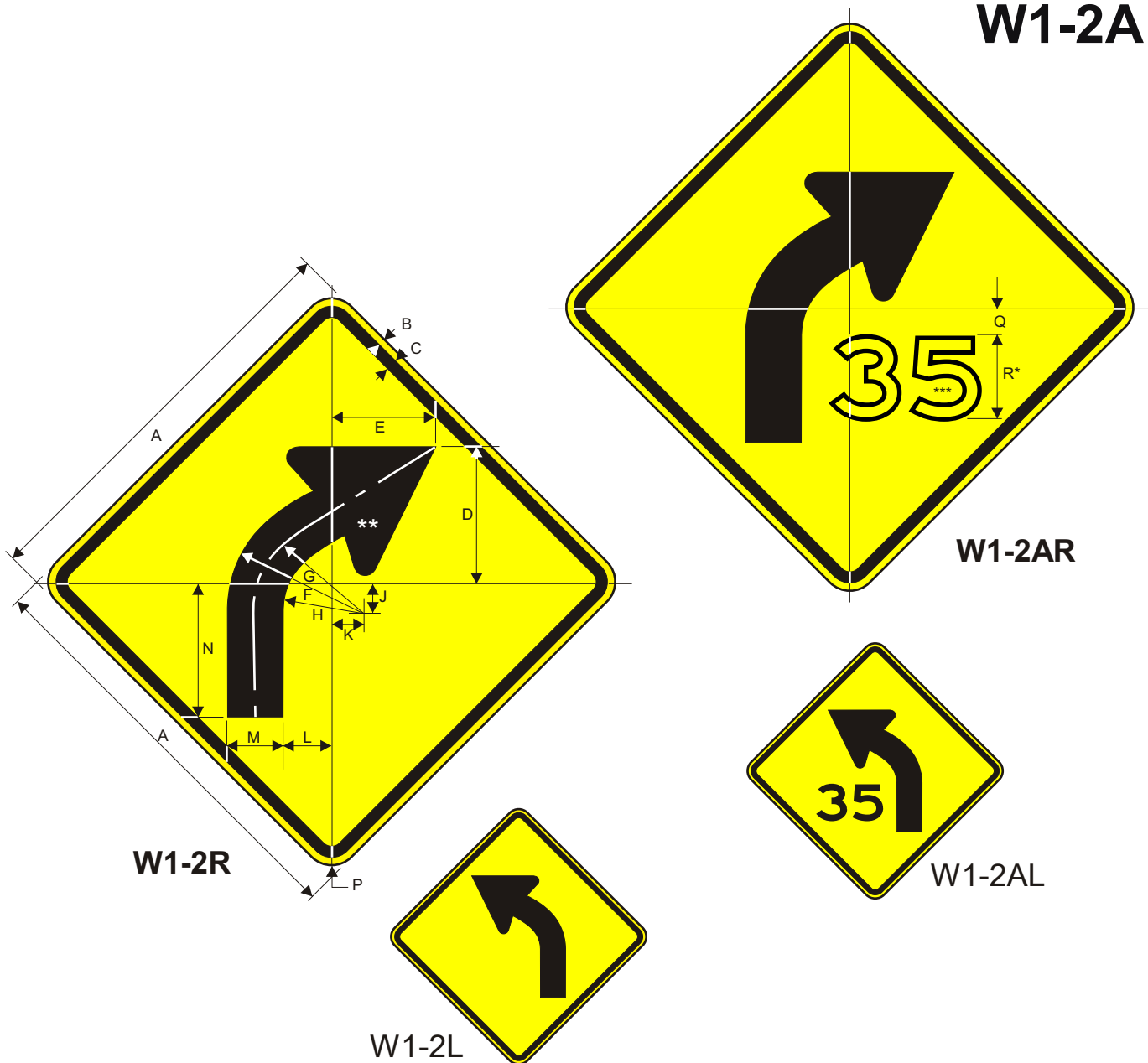

Border and Legend: Black
Background: Yellow

*See Appendix B-1 for Standard Arrow Details.
**Optically position numerals.

Road Class	Dimensions (inches)															
	A	B	C	D	E	F	G	H	J	K	L	M	N	P	Q	R
Bike	18	0.38	0.63	5.41	5.14	6.0	4.69	3.38	1.8	1.31	2.06	2.63	6.19	1.5	1.5	4E
Minimum	24	0.38	0.63	7.09	7.25	8.0	6.25	4.5	2.3	1.75	2.75	3.5	8.3	1.5	2.5	5E
Conventional	30	0.5	0.75	8.88	9.06	10	7.81	5.63	2.9	2.19	2.44	4.38	10.31	1.88	2.0	6E
Expy/Fwy	36	0.63	0.88	10.63	10.88	12	9.38	6.75	3.5	2.63	4.13	5.25	12.38	2.25	3.0	7E
Oversized	48	0.75	1.25	14.19	14.5	16	12.5	9.0	4.7	3.5	5.5	7.0	16.5	3.0	5.0	9E

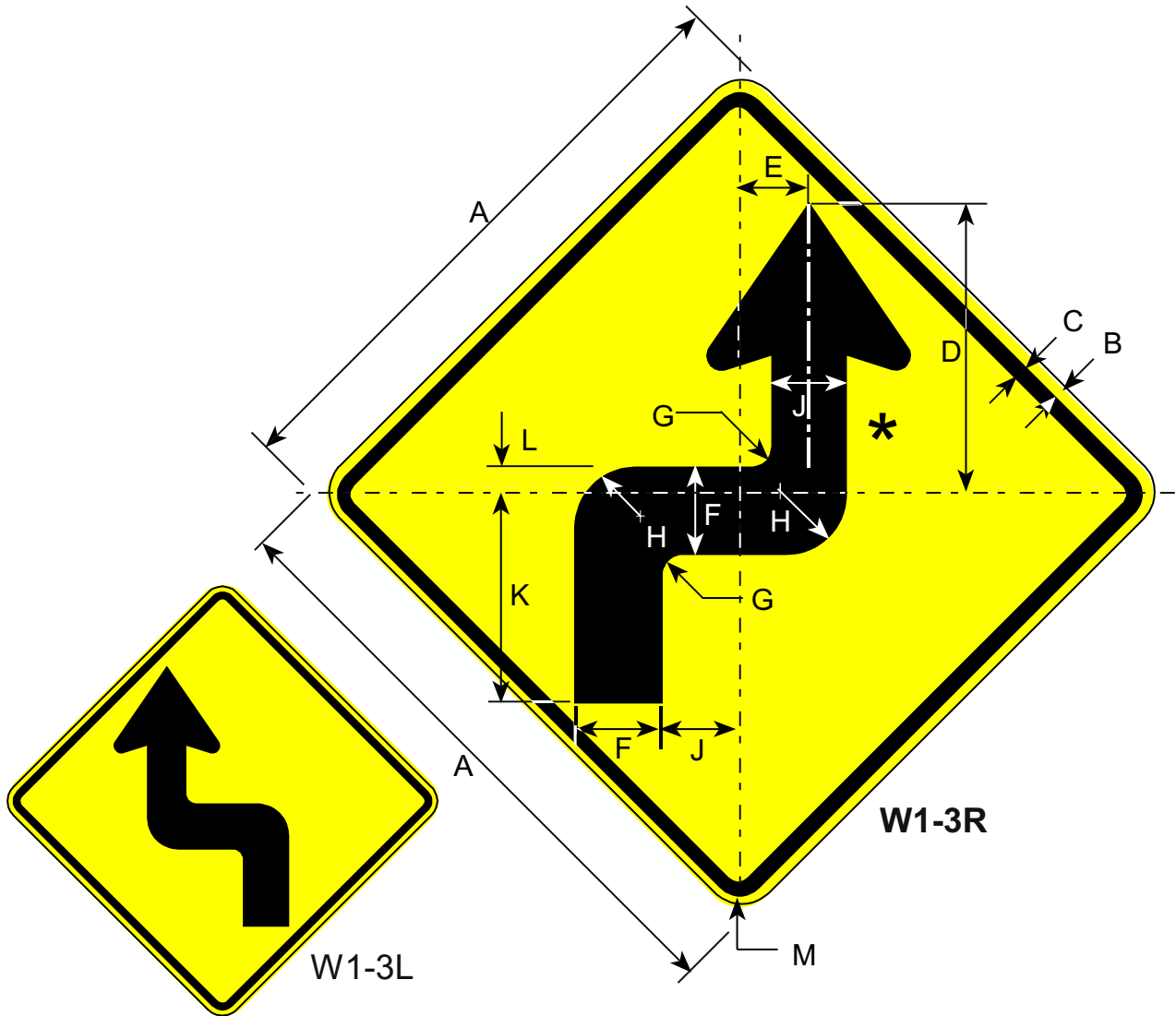

Border and Legend: Black
Background: Yellow

* See Appendix B-1 for Standard Arrow Details.

Road Class	Dimensions (inches)											
	A	B	C	D	E	F	G	H	J	K	L	M
Bike	24	0.38	0.63	11	2.81	3.5	0.81	2.5	3.0	8.31	1.09	1.5
Minimum	30	0.50	0.75	14.50	3.5	4.38	1.0	3.0	3.75	10.38	1.38	1.88
Conventional	36	0.63	0.88	17.44	4.22	5.25	1.25	3.63	4.5	12.47	1.66	2.25
Expwy/Fwy	48	0.75	1.25	23.19	5.63	7.0	1.63	4.88	6.0	16.63	2.19	3.0

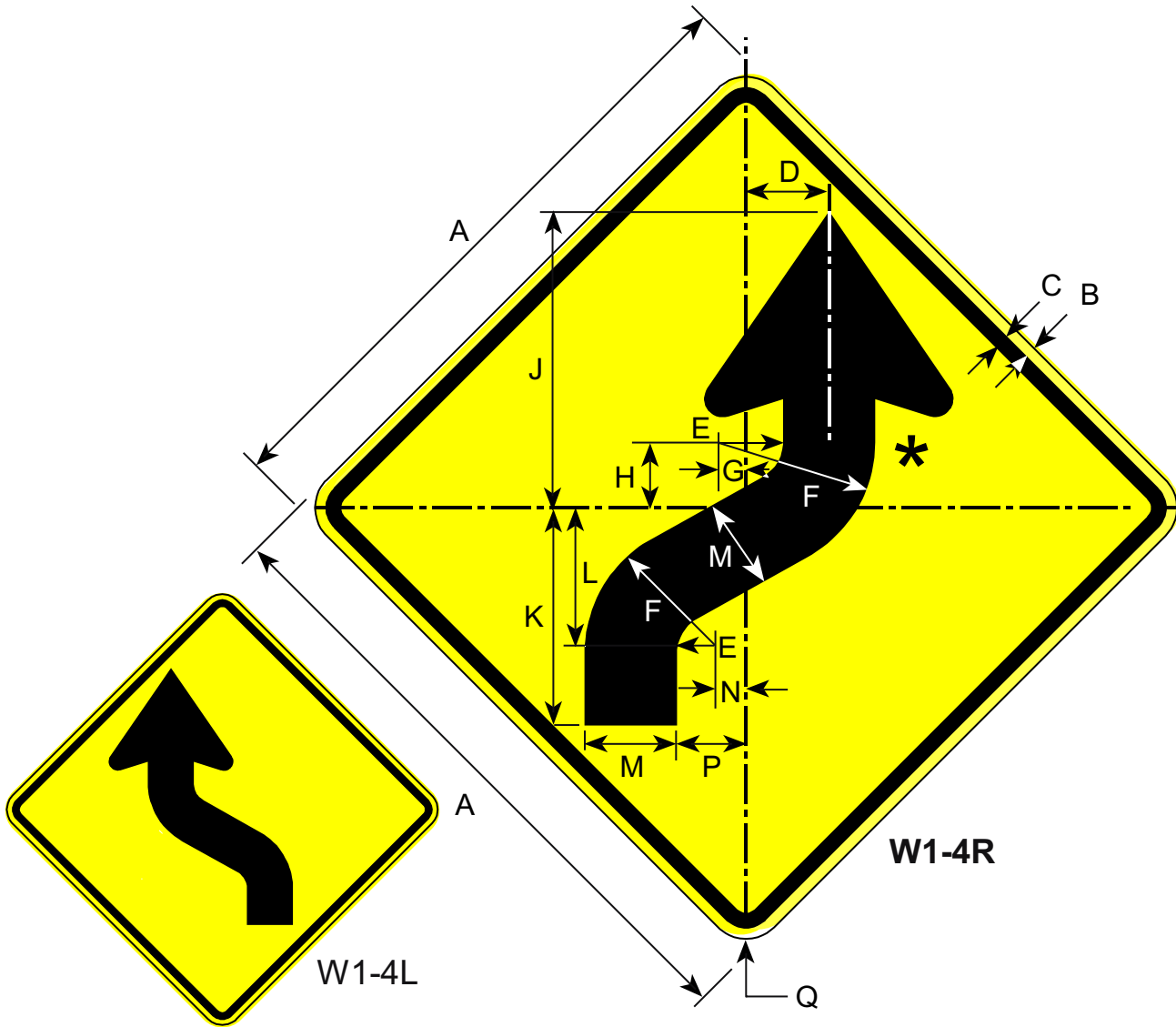

Border and Legend: Black
Background: Yellow

* See Appendix B-1 for Standard Arrow Details.

Road Class	Dimensions (inches)														
	A	B	C	D	E	F	G	H	J	K	L	M	N	P	Q
Bike	18	0.50	0.63	2.38	1.13	3.75	0.06	2.63	8.63	6.25	4.0	2.63	0.88	2.0	1.5
Minimum	30	0.50	0.75	3.94	1.88	6.25	0.13	4.38	14.06	10.94	6.56	4.38	1.81	3.28	1.88
Conventional	36	0.63	0.88	4.72	2.25	7.5	0.15	5.25	16.88	12.38	7.88	5.25	1.0	3.94	2.25
Expwy/Fwy	48	0.75	1.25	6.31	3.0	10	0.19	7.0	22.5	16.5	10.5	7.0	2.25	5.25	3.0

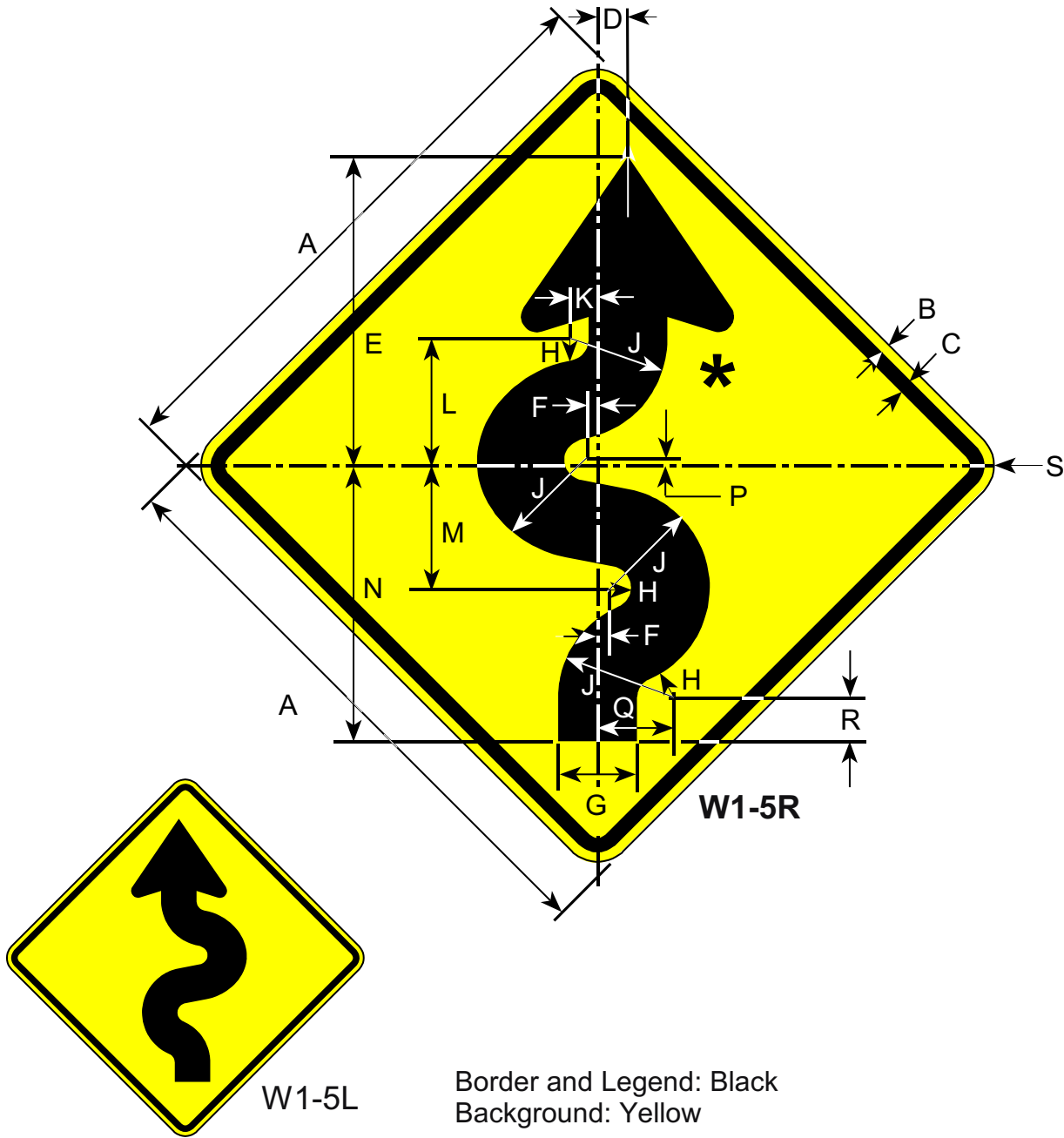

* See Appendix B-1 for Standard Arrow Details.

Road Class	Dimensions (inches)															
	A	B	C	D	E	F	G	H	J	K	L	M	N	P	Q	R
Bike	18	0.38	0.63	1.0	9.63	0.38	2.5	0.63	3.0	1.0	4.0	4.0	8.63	0.25	2.0	1.25
Minimum	30	0.50	0.75	1.56	15.06	0.63	4.06	1.09	5.16	1.56	6.56	6.56	14.22	0.31	3.13	2.0
Conventional	36	0.63	0.88	1.88	19.13	0.75	4.88	1.31	6.19	1.88	7.78	7.88	17.06	0.38	3.75	2.41
Expwy/Fwy	48	0.75	1.25	2.5	25.5	1.0	6.5	1.75	8.25	2.5	10.38	10.5	22.75	0.50	5.0	3.19

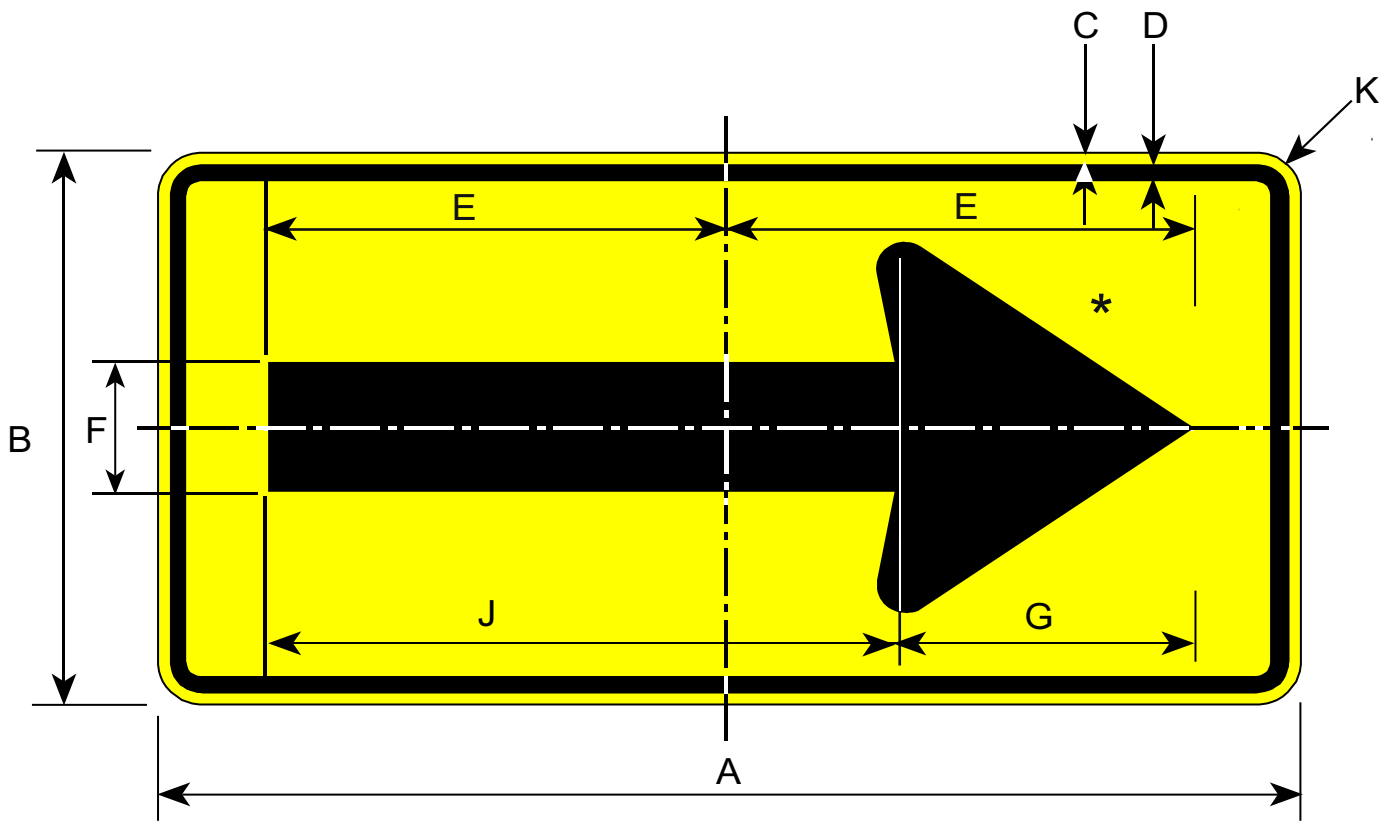

W1-6R

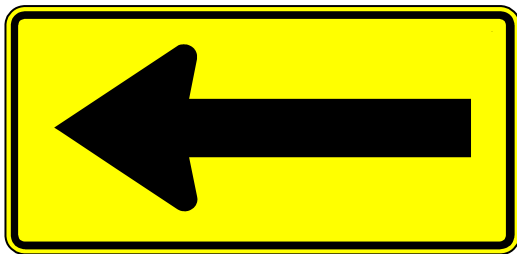

W1-6L

Border and Legend: Black
Background: Yellow

* See Appendix B-1 for Standard Arrow Details.

Road Class	Dimensions (inches)								
	A	B	C	D	E	F	G	J	K
Minimum	36	18	0.38	0.63	14.63	5.0	10.13	19.13	1.5
Conventional	48	24	0.50	0.75	19.5	6.5	13.19	25.81	1.88
Expwy/Fwy	60	30	0.63	0.88	24.38	8.0	16.25	32.5	2.25

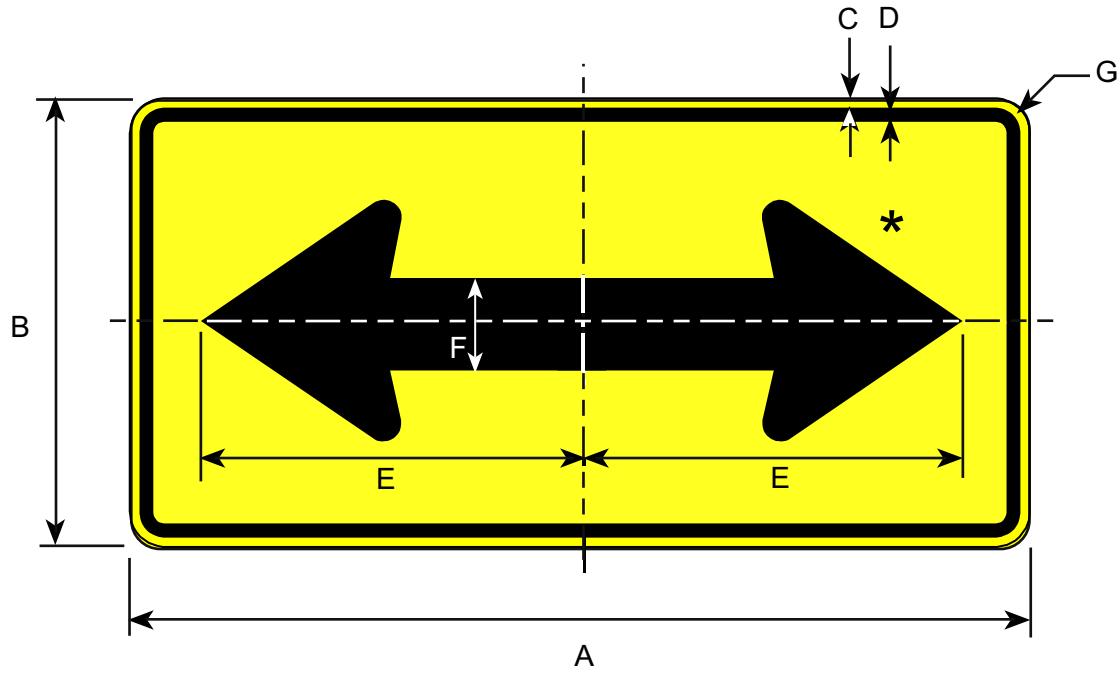

Border and Legend: Black
Background: Yellow

* See Appendix B-1 for Standard Arrow Details.

Road Class	Dimensions (inches)						
	A	B	C	D	E	F	G
Bike	24	12	0.38	0.63	10.38	3.25	1.50
Minimum	36	18	0.38	0.63	15.63	5.00	1.50
Conventional	48	24	0.50	0.75	20.50	6.50	1.88
Expwy/Fwy	60	30	0.63	0.88	25.38	8.00	2.25
Oversized	96	48	0.75	1.25	41.00	12.50	3.00

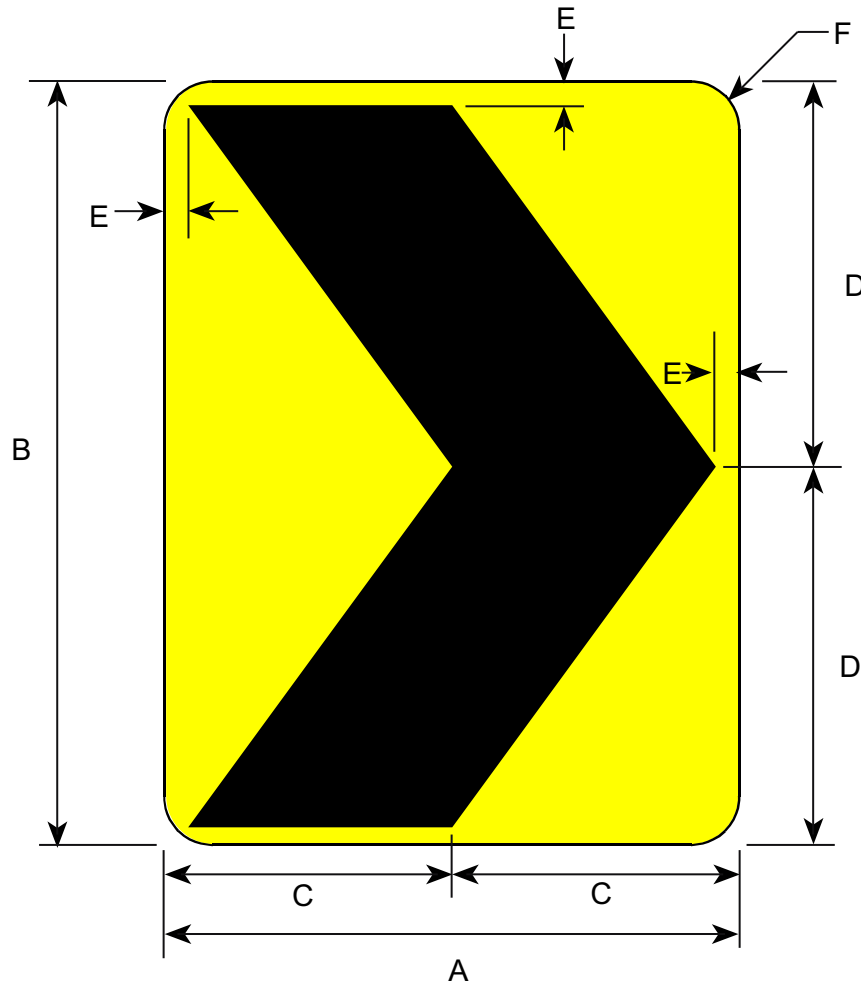

Border and Legend: Black
Background: Yellow

Make symbol proportional
to the one shown.

Road Class	Dimensions (inches)					
	A	B	C	D	E	F
Bike	12	18	6	9	0.50	1.50
Minimum	18	24	9	12	0.75	1.50
Conventional	24	30	12	15	0.88	1.50
Expwy	30	36	15	18	1.00	1.88
Freeway	36	48	18	24	1.13	2.25

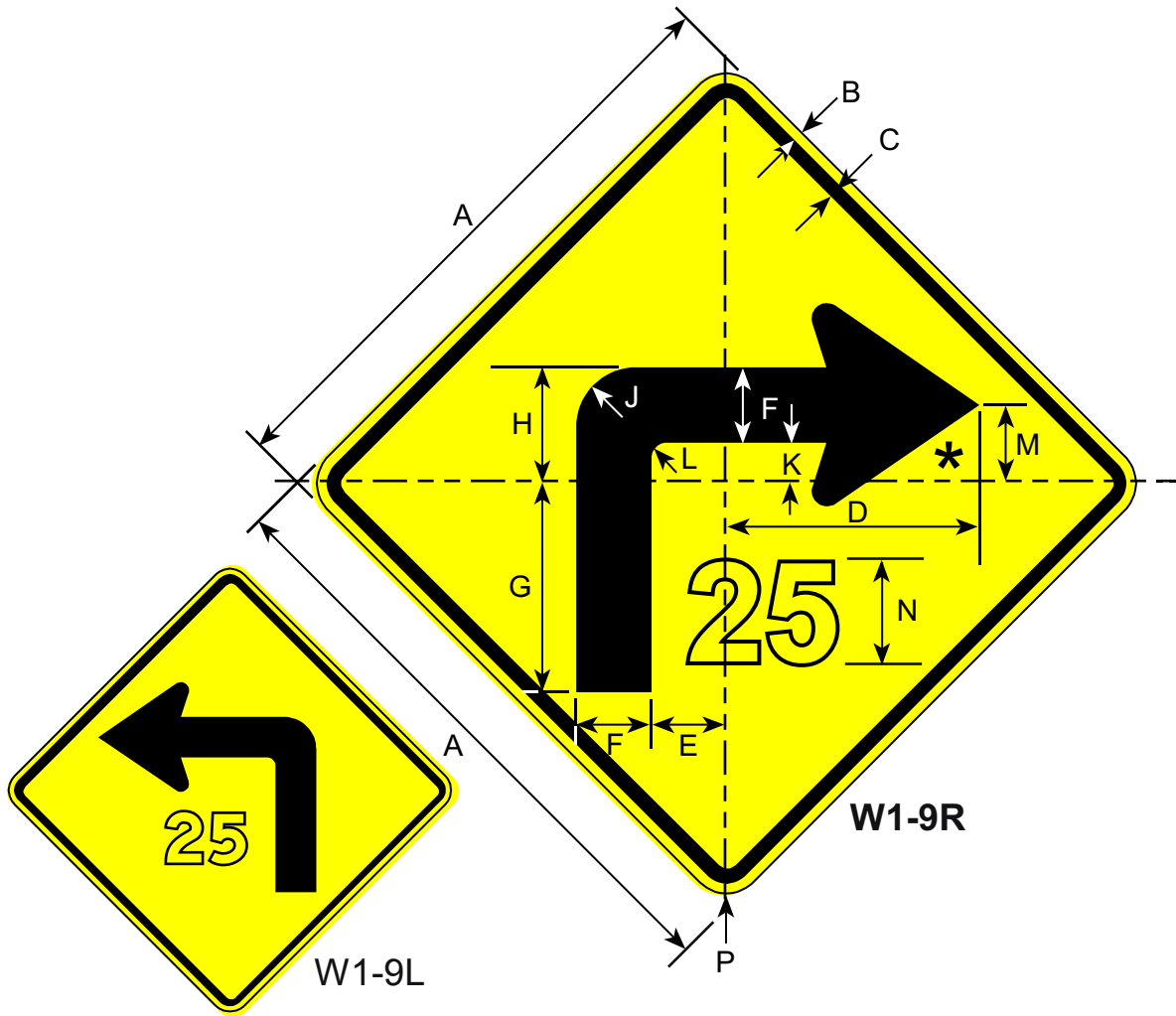

Border and Legend: Black
Background: Yellow

* See Appendix B-1 for Standard Arrow Details.

Road Class	Dimensions (inches)													
	A	B	C	D	E	F	G	H	J	K	L	M	N	P
Bike	18	0.38	0.63	7.25	2.25	2.63	5.88	3.75	1.88	1.0	0.63	2.5	4E	1.5
Conv & Min	36	0.63	0.88	14.38	4.5	5.25	11	7.5	3.63	2.25	1.25	4.88	7E	2.25
45 MPH, or Greater	48	0.75	1.25	19.19	6.0	7.0	15.5	10	4.88	3.0	1.63	6.5	9E	3.0

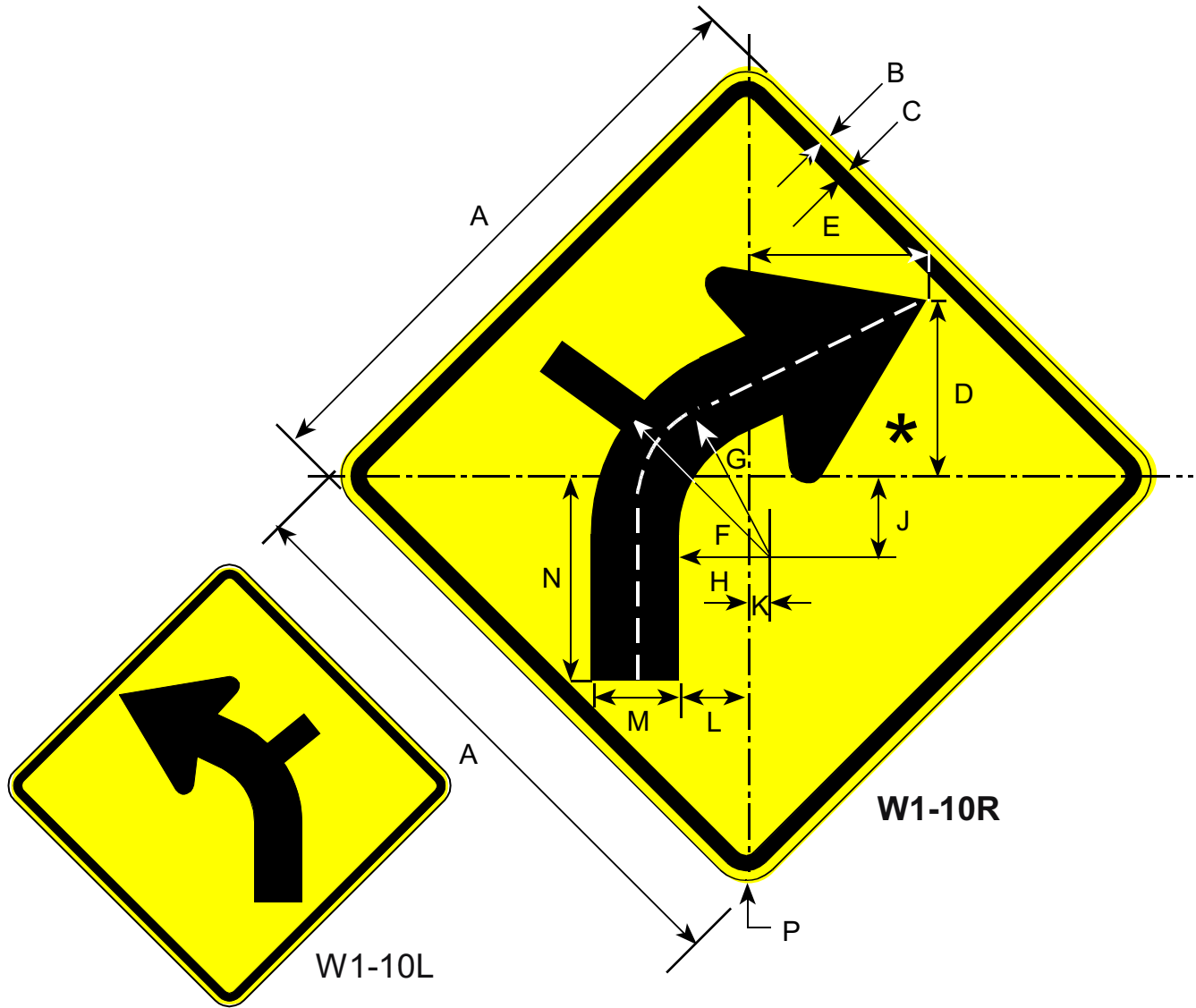

Border and Legend: Black
Background: Yellow

* See Appendix B-1 for Standard Arrow Details.

Road Class	Dimensions (inches)														
	A	B	C	D	E	F	G	H	J	K	L	M	N	P	
Bike	18	0.38	0.63	5.38	5.5	6.0	4.75	3.38	1.75	1.25	2.0	2.63	6.25	1.5	
Minimum	30	0.50	0.75	8.88	9.06	10	7.81	5.63	2.94	2.19	3.44	4.38	10.31	1.88	
Conventional	36	0.63	0.88	10.88	10.88	12	9.38	6.75	3.5	2.63	4.25	5.25	12.38	2.25	
Expwy/Fwy	48	0.75	1.25	14.81	14.25	16	12.5	9.0	4.0	3.5	5.5	7.0	16.5	3.0	

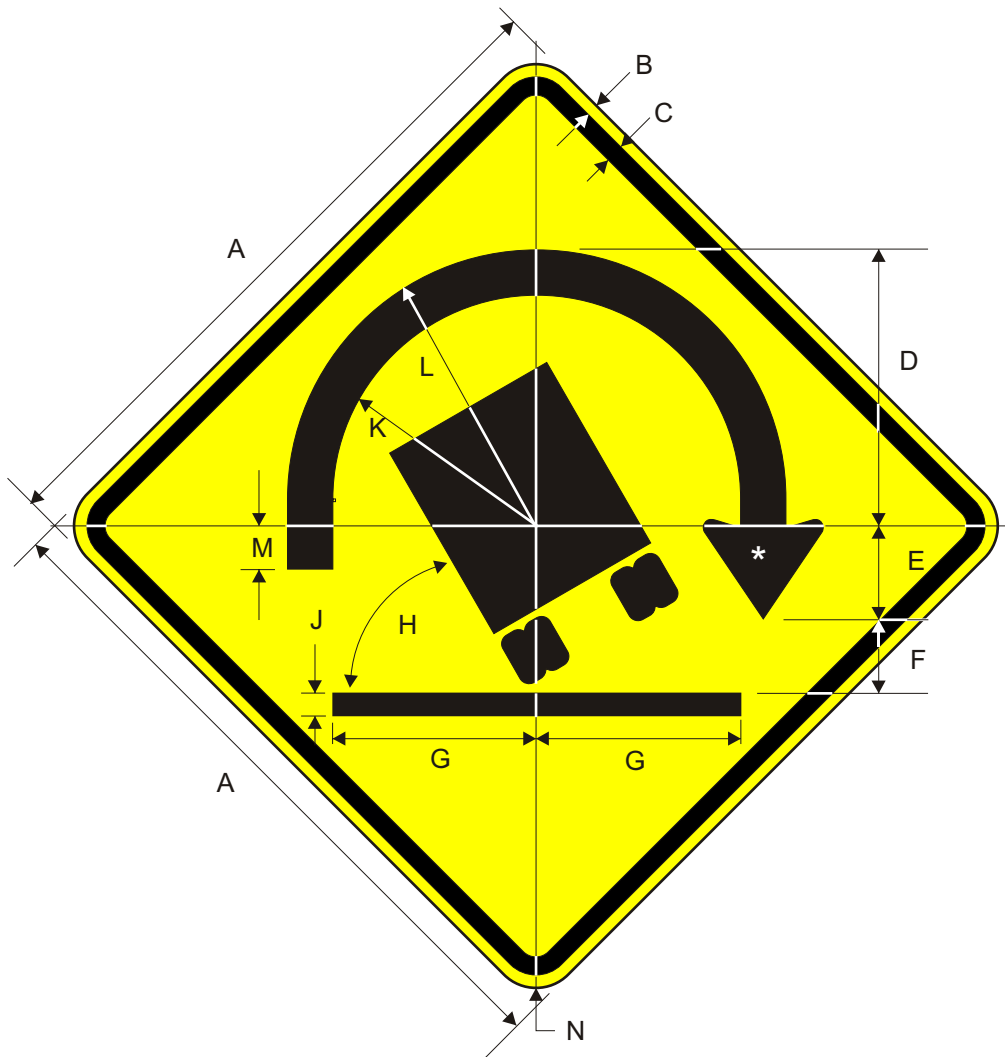

Border and Legend: Black
Background: Yellow

* See Appendix B-1 for Standard Arrow Details.

Road Class	Dimensions (inches)												
	A	B	C	D	E	F	G	H	J	K	L	M	N
Minimum	30	0.50	0.75	12.21	4.12	3.32	9.05	60°	0.96	10.21	12.21	1.92	1.88
Conventional	36	0.63	0.88	14.65	4.96	4.0	10.85	60°	1.16	12.25	14.65	2.32	2.25
Expy/Fwy	48	0.75	1.25	19.53	6.61	5.32	14.49	60°	1.52	16.33	19.53	3.08	3.0

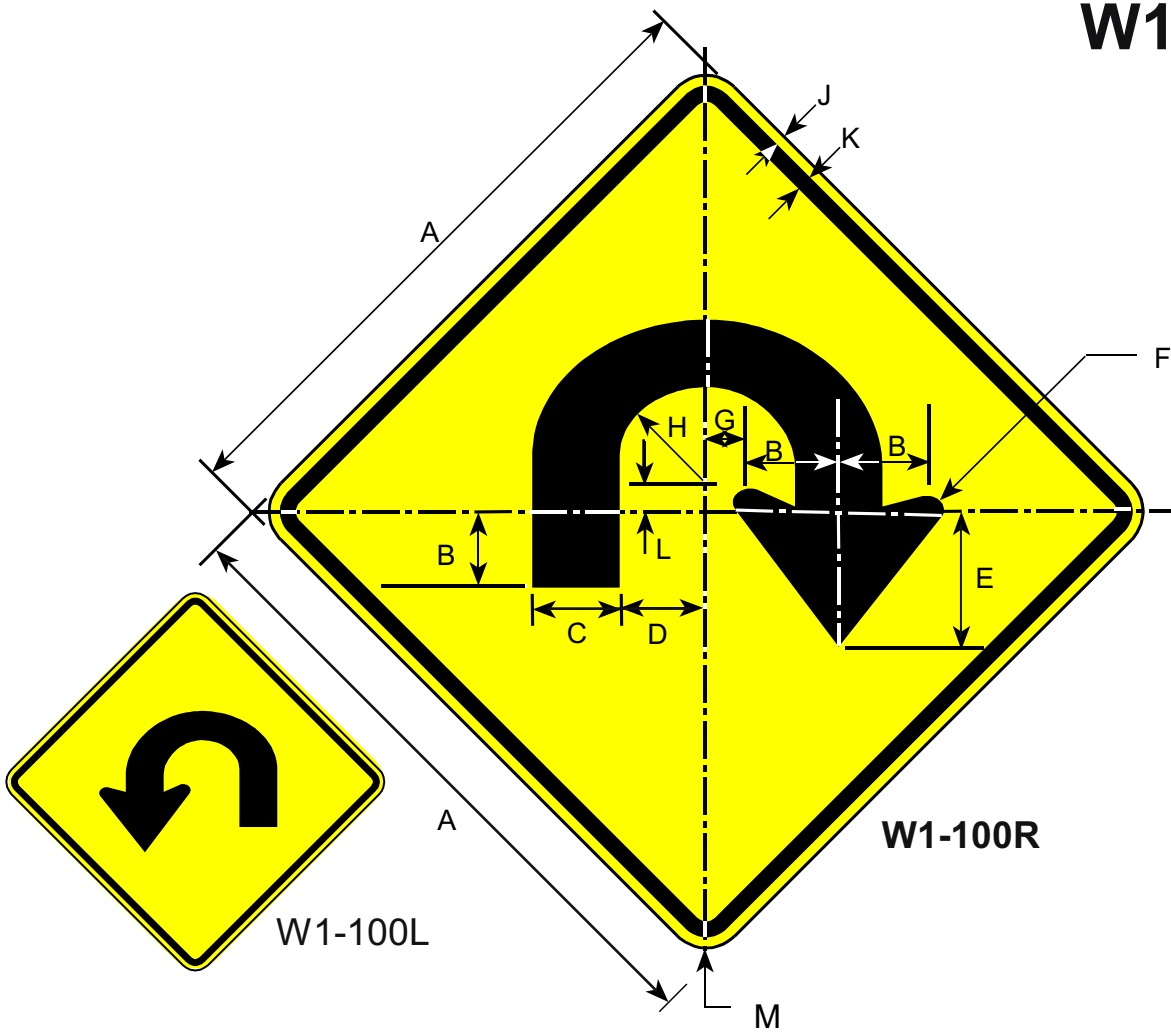

Border and Legend: Black
Background: Yellow

* See Appendix B-1 for Standard Arrow Details.

Prior to 2002 publication of this manual, this sign was numbered W1-9.

Road Class	Dimensions (inches)												
	A	B	C	D	E	F	G	H	J	K	L	M	
Minimum	30	5.0	4.38	5.75	8.75	0.75	0.25	7.0	0.88	0.50	0.75	1.88	
Conventional	36	6.0	5.25	6.88	10.5	0.94	0.30	7.5	1.13	0.63	0.88	2.25	
Expwy/Fwy	48	8.0	7.0	9.25	14	1.19	0.38	9.0	1.5	0.75	1.25	3.0	

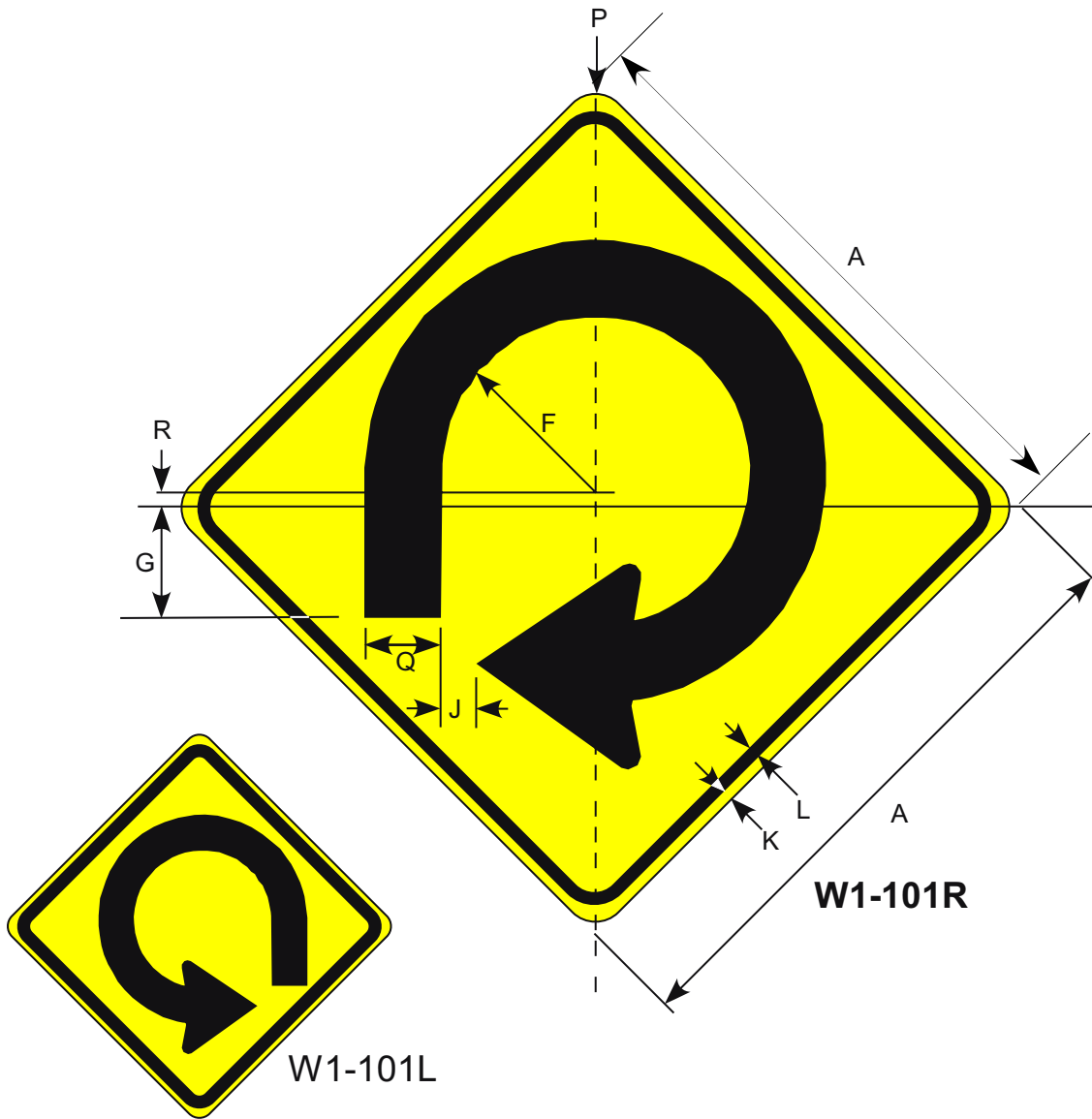

Border and Legend: Black
Background: Yellow

* See Appendix B-1 for Standard Arrow Details.

Prior to 2002 publication of this manual, this sign was numbered W1-10.

Road Class	Dimensions (inches)								
	A	F	G	J	K	L	P	Q	R
Minimum	30	8.13	6.56	2.0	0.75	0.50	1.88	3.75	0.94
Standard	36	9.75	0.88	2.38	0.88	0.63	2.25	4.5	1.13
Expwy/Fwy	48	13	10.5	3.13	1.25	0.75	3.0	6.0	1.5

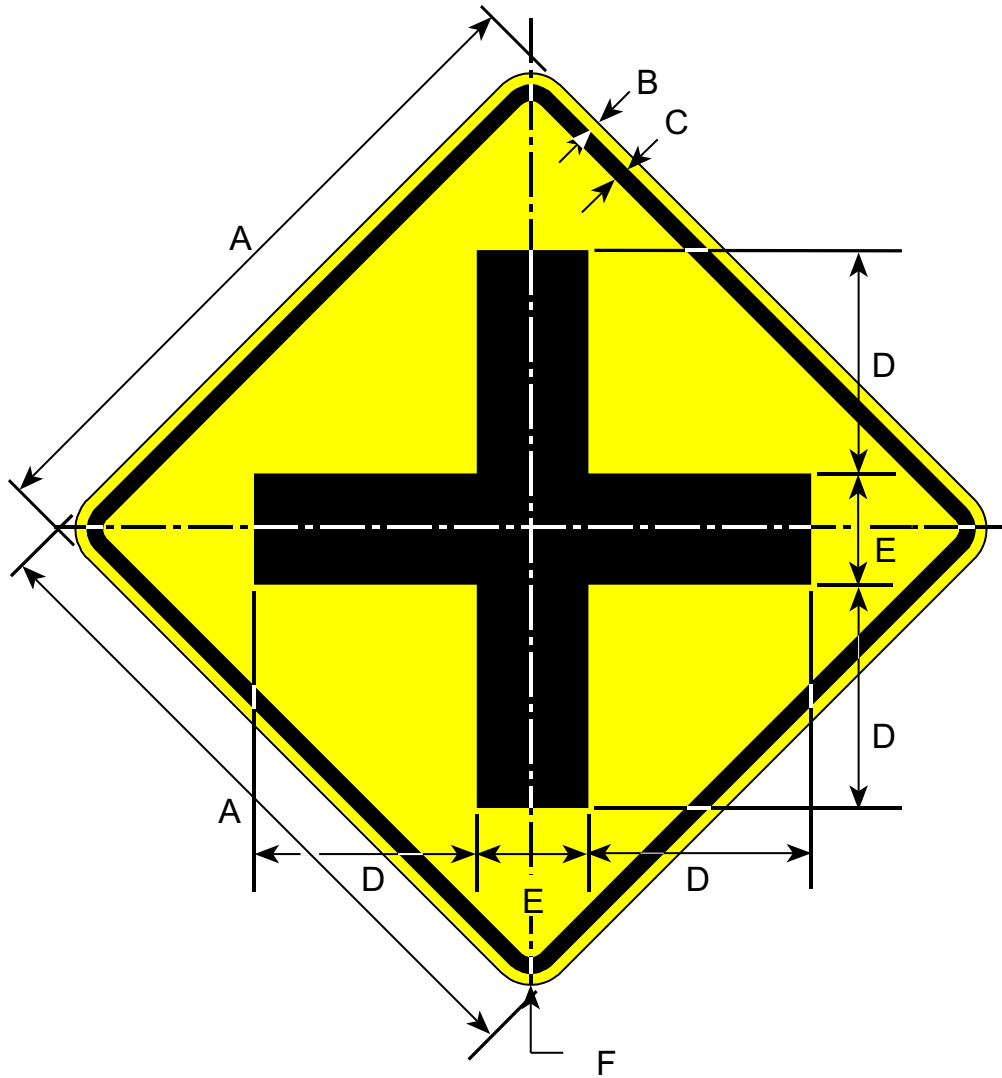

Border and Legend: Black
Background: Yellow

Road Class	Dimensions (inches)					
	A	B	C	D	E	F
Bike	18	0.38	0.63	6	3	1.50
Minimum	30	0.50	0.75	10	5	1.88
Conventional	36	0.63	0.88	12	6	2.25
Expwy/Fwy	48	0.75	1.25	16	8	3.00

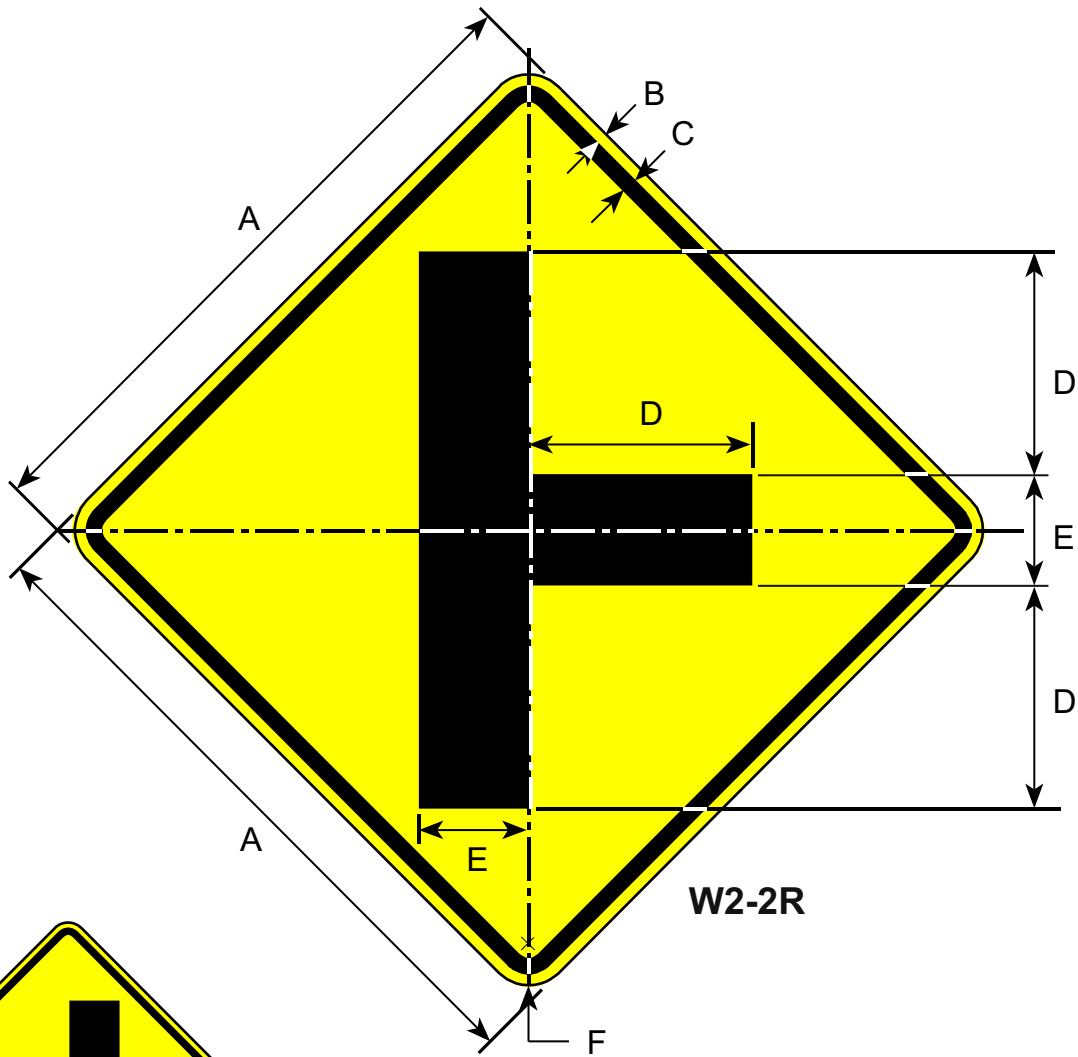

W2-2R



W2-2L

Border and Legend: Black
Background: Yellow

Road Class	Dimensions (inches)					
	A	B	C	D	E	F
Bike	18	0.38	0.63	6.0	3.0	1.5
Minimum	30	0.50	0.75	10	5.0	1.88
Conventional	36	0.63	0.88	12	6.0	2.25
Expwy/Fwy	48	0.75	1.25	16	8.0	3.0

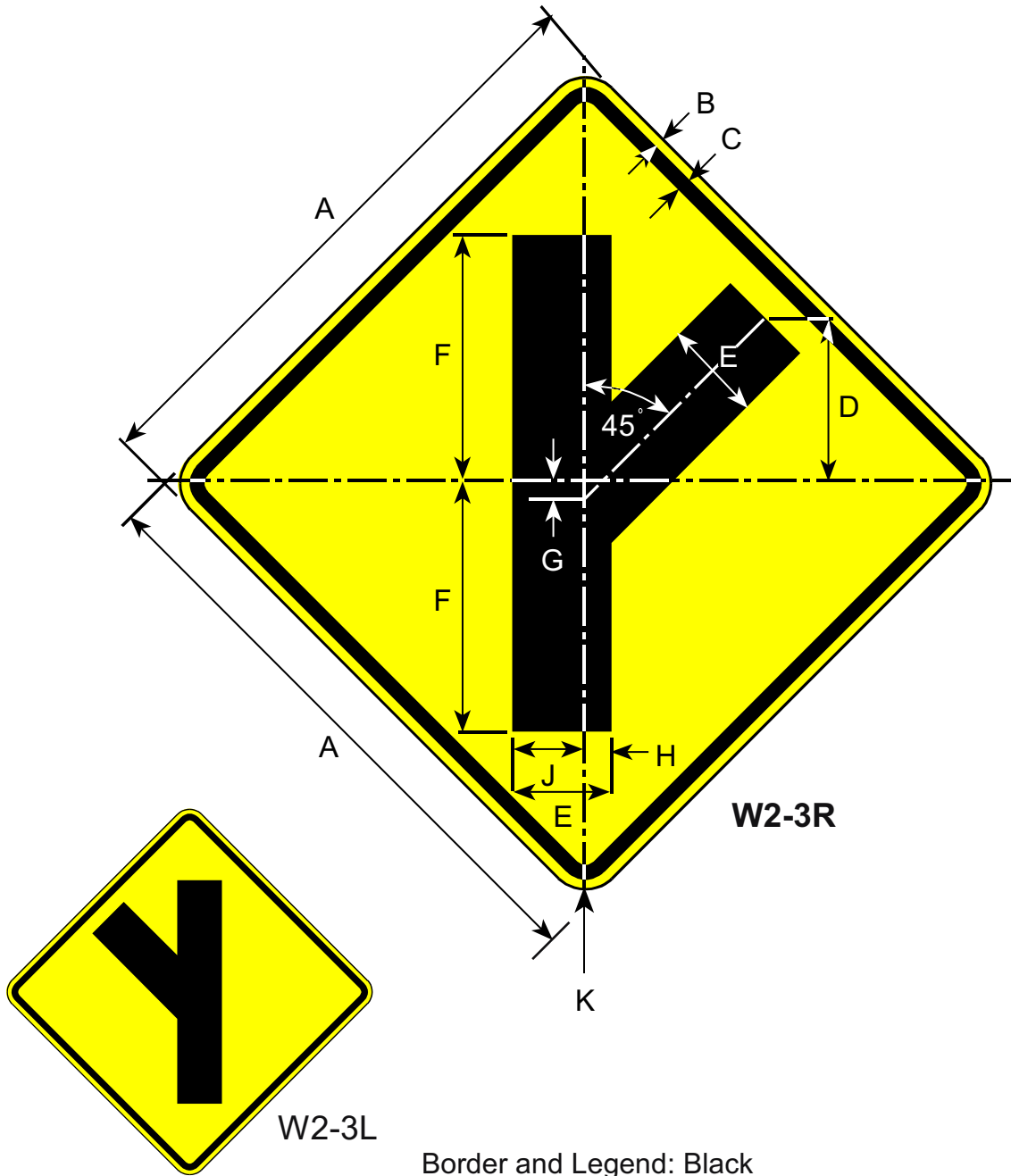

Border and Legend: Black
Background: Yellow

Road Class	Dimensions (inches)									
	A	B	C	D	E	F	G	H	J	K
Bike	18	0.38	0.63	5.0	3.0	7.75	0.38	0.75	2.25	1.5
Minimum	24	0.38	0.63	6.66	4.0	10	0.56	1.0	3.0	1.5
Conventional	30	0.50	0.75	8.31	5.0	12.5	0.66	1.25	3.75	1.88
Expwy	36	0.63	0.88	10	6.0	15	0.84	1.5	4.5	2.25
Freeway	48	0.75	1.25	13.31	7.0	20	1.13	2.0	6.0	3.0

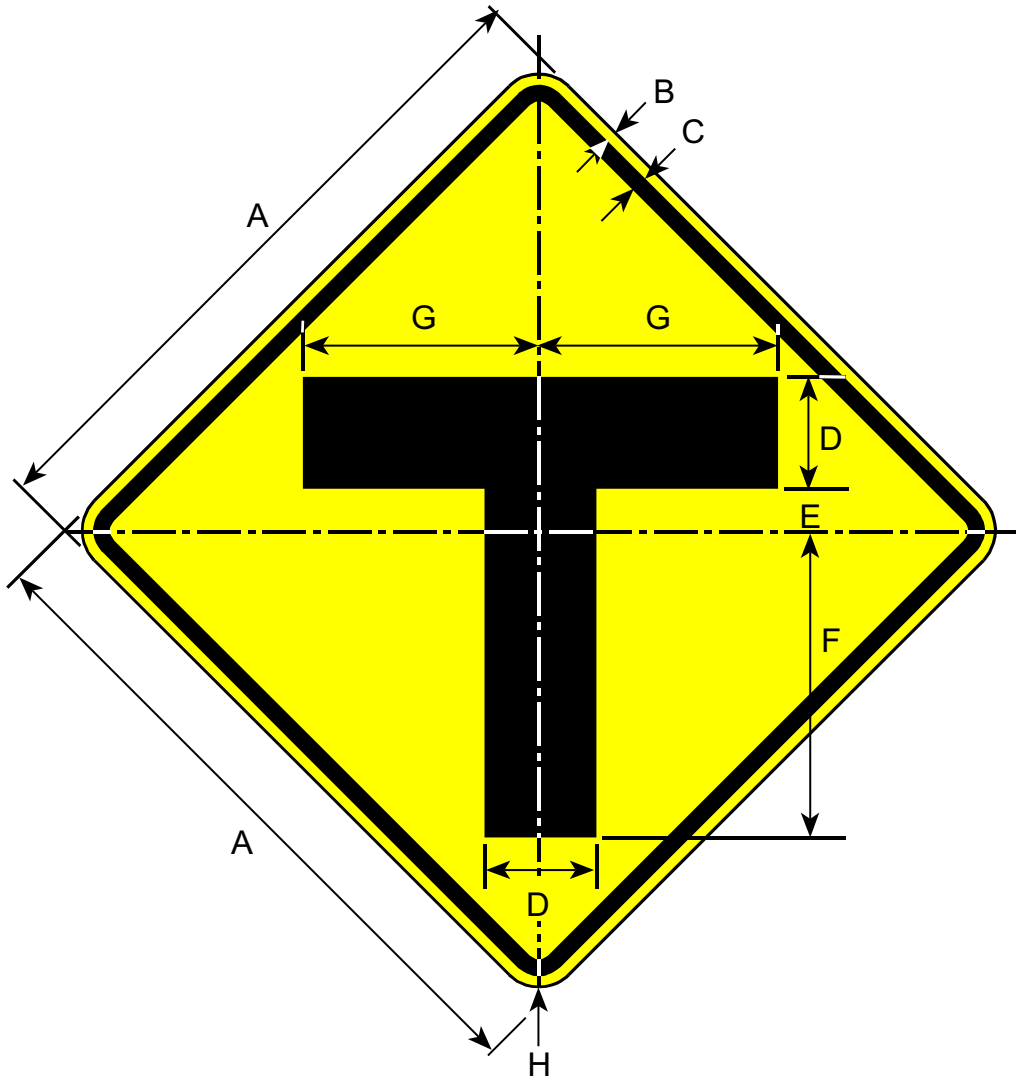

Border and Legend: Black
Background: Yellow

Road Class	Dimensions (inches)							
	A	B	C	D	E	F	G	H
Bike	18	0.38	0.63	3.0	1.25	8.38	6.38	1.5
Minimum	30	0.50	0.75	5.0	1.88	13.75	10.63	1.88
Conventional	36	0.63	0.88	6.0	2.25	16.5	12.75	2.25
Expwy/Fwy	48	0.75	1.25	8.0	3.0	22	17	3.0

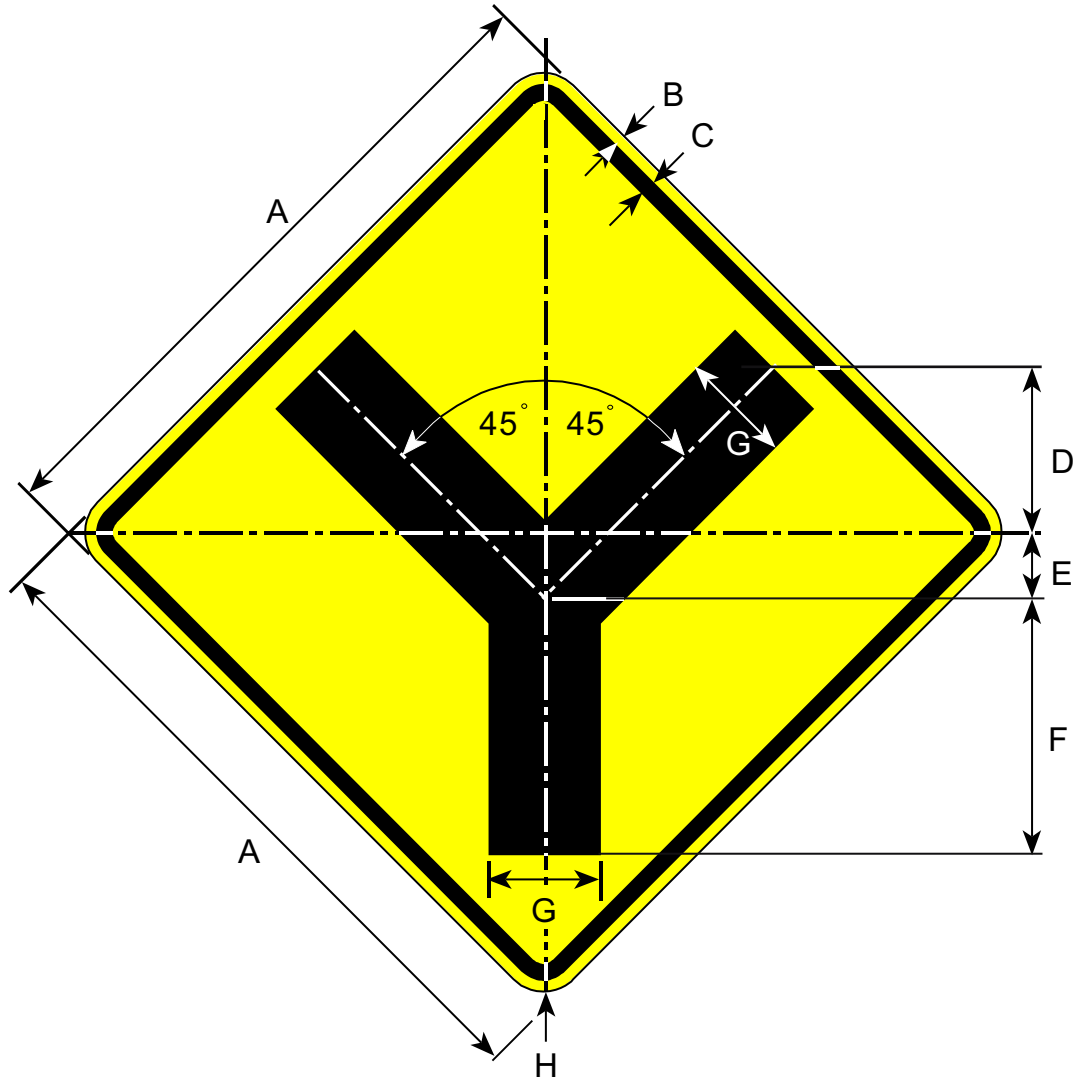

Border and Legend: Black
Background: Yellow

Road Class	Dimensions (inches)							
	A	B	C	D	E	F	G	H
Bike	18	0.38	0.63	4.50	1.75	6.66	3	1.50
Minimum	30	0.50	0.75	7.38	3.00	11.25	5	1.88
Conventional	36	0.63	0.88	8.84	3.59	13.50	6	2.25
Expwy/Fwy	48	0.75	1.25	11.66	4.75	18.00	8	3.00

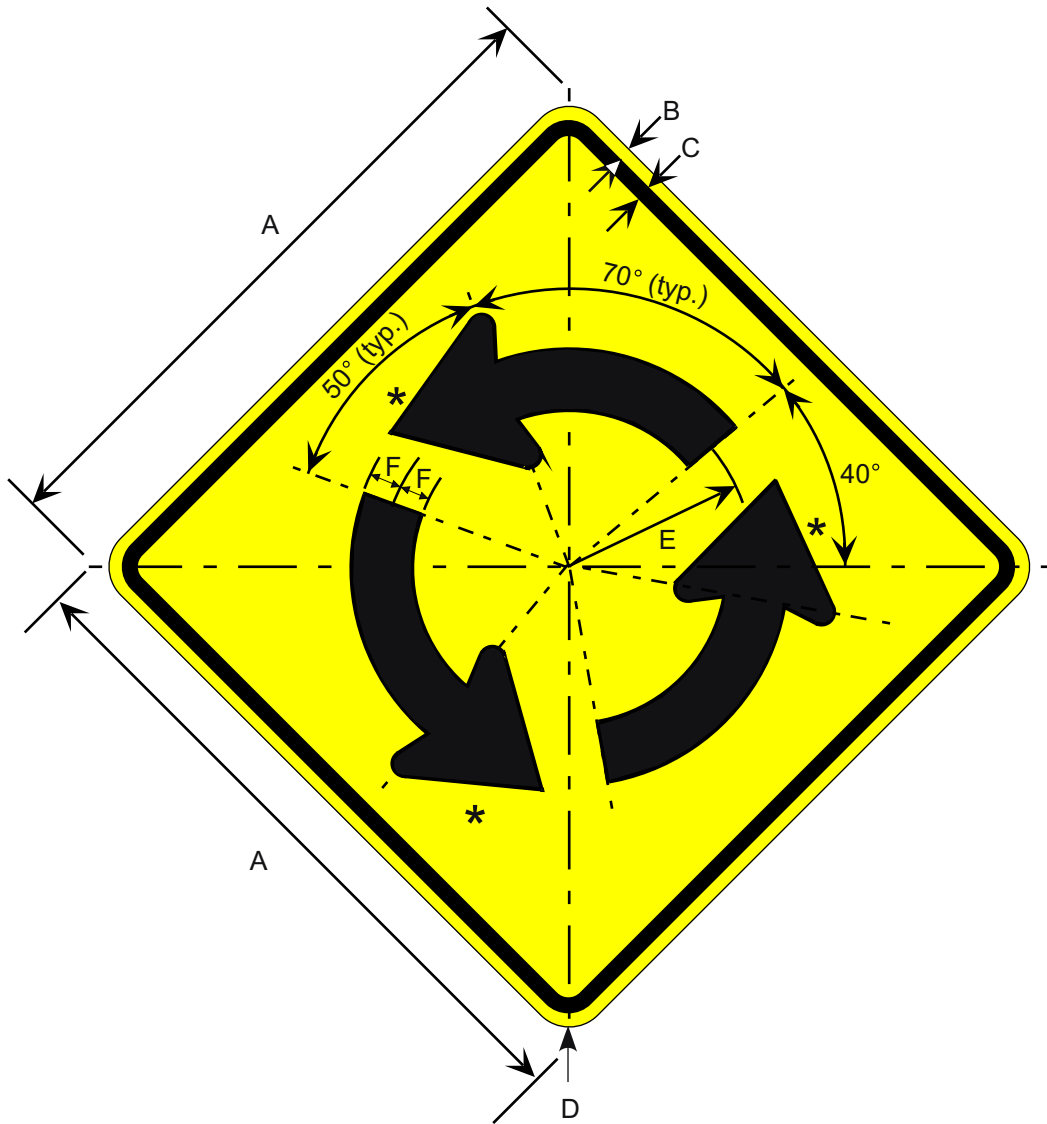

Border and Legend: Black
Background: Yellow

Make symbol proportional
to the one shown.

* See Appendix B-1 for Standard Arrow Details.

Road Class	Dimensions (inches)					
	A	B	C	D	E	F
Conventional	36	0.63	0.88	2.25	10	1.63
Expressway	48	0.75	1.25	3.0	13.25	2.13

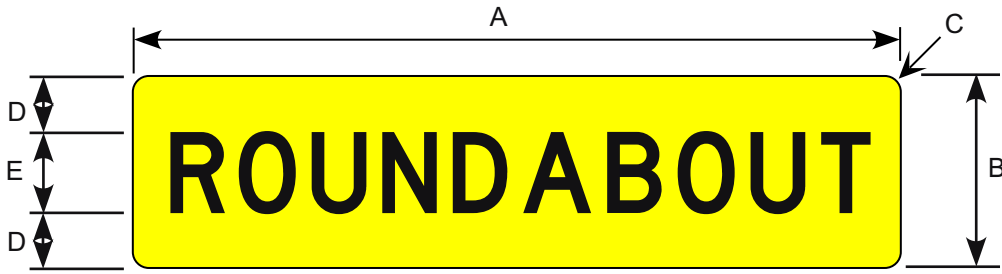

Border and Legend: Black
Background: Yellow

Road Class	Dimensions (inches)				
	A	B	C	D	E
Conv & Min	36	12	1.5	3.5	5C
Expressway	48	12	2.0	3.0	6C

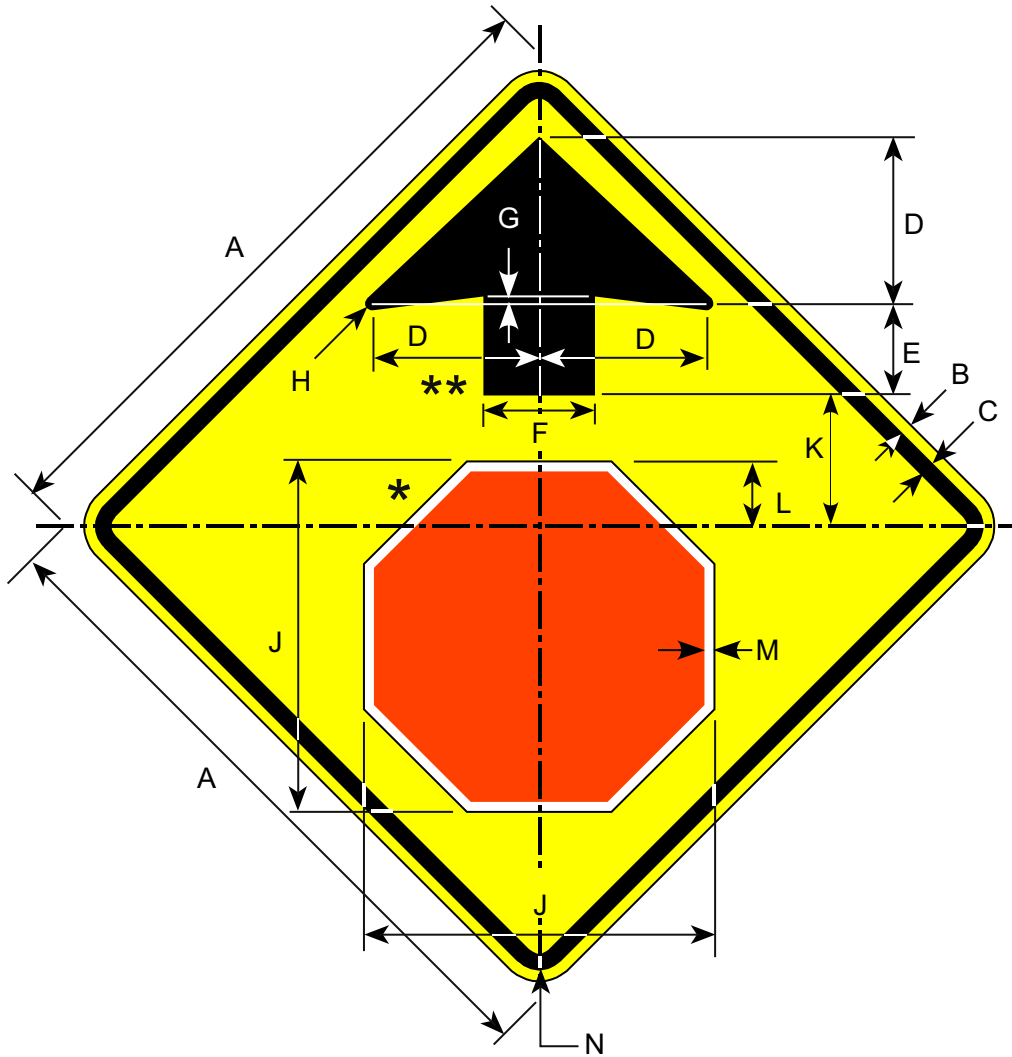

Border and Legend: Black
 Background: Yellow
 Symbol: White Border on Red Background

* Make symbol proportional to the one shown.
 ** See Appendix B-3 for Arrow Details.

Prior to the 2002 publication of this manual, this sign was numbered W3-1.

Road Class	Dimensions (inches)												
	A	B	C	D	E	F	G	H	J	K	L	M	N
Minimum	30	0.50	0.75	7.5	3.75	5.0	0.63	0.31	15.75	6.25	2.88	0.50	1.88
Conventional	36	0.63	0.88	9.0	4.5	6.0	0.75	0.38	19	7.5	3.5	0.63	2.25
Expwy/Fwy	48	0.75	1.25	12	6.0	8.0	1.0	0.50	25.13	10	4.5	0.75	3.0

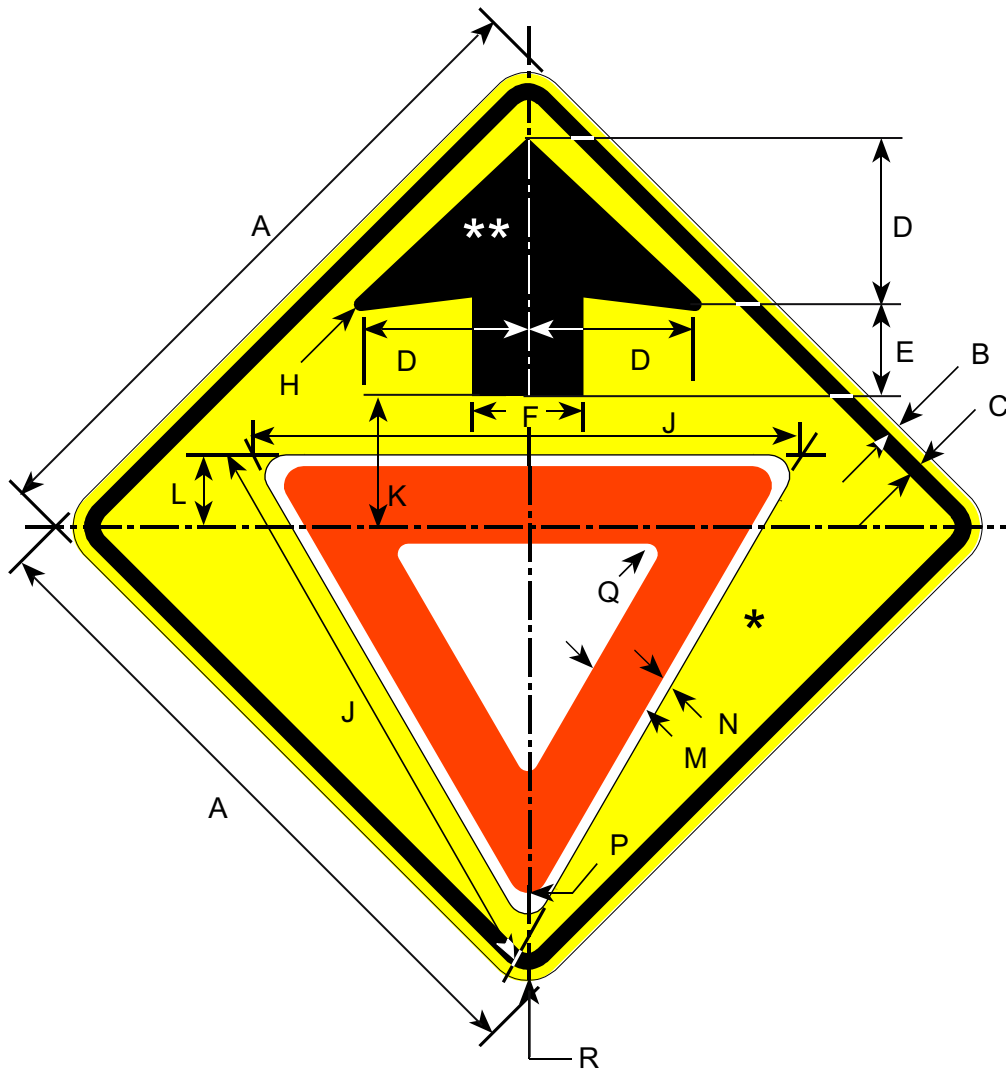

Border and Legend: Black
 Background: Yellow
 Symbol: Red Border on White Background

- * Make symbol proportional to the one shown.
- ** See Appendix B-3 for Arrow Details.

Prior to the 2002 publication of this manual, this sign was numbered W3-2.

Prior to the 2006 publication of this manual, this sign was numbered W3-2A.

Road Class	Dimensions (inches)														
	A	B	C	D	E	F	H	J	K	L	M	N	P	Q	R
Minimum	30	0.50	0.75	7.5	3.75	5.0	0.31	25	6.25	3.0	3.38	0.50	1.25	0.63	1.88
Conventional	36	0.63	0.88	9.0	4.5	6.0	0.38	28	7.5	3.38	3.75	0.63	1.38	0.75	2.25
Expwy/Fwy	48	0.75	1.25	12	6.0	8.0	0.50	38	10	4.5	5.0	0.75	1.88	1.0	3.0

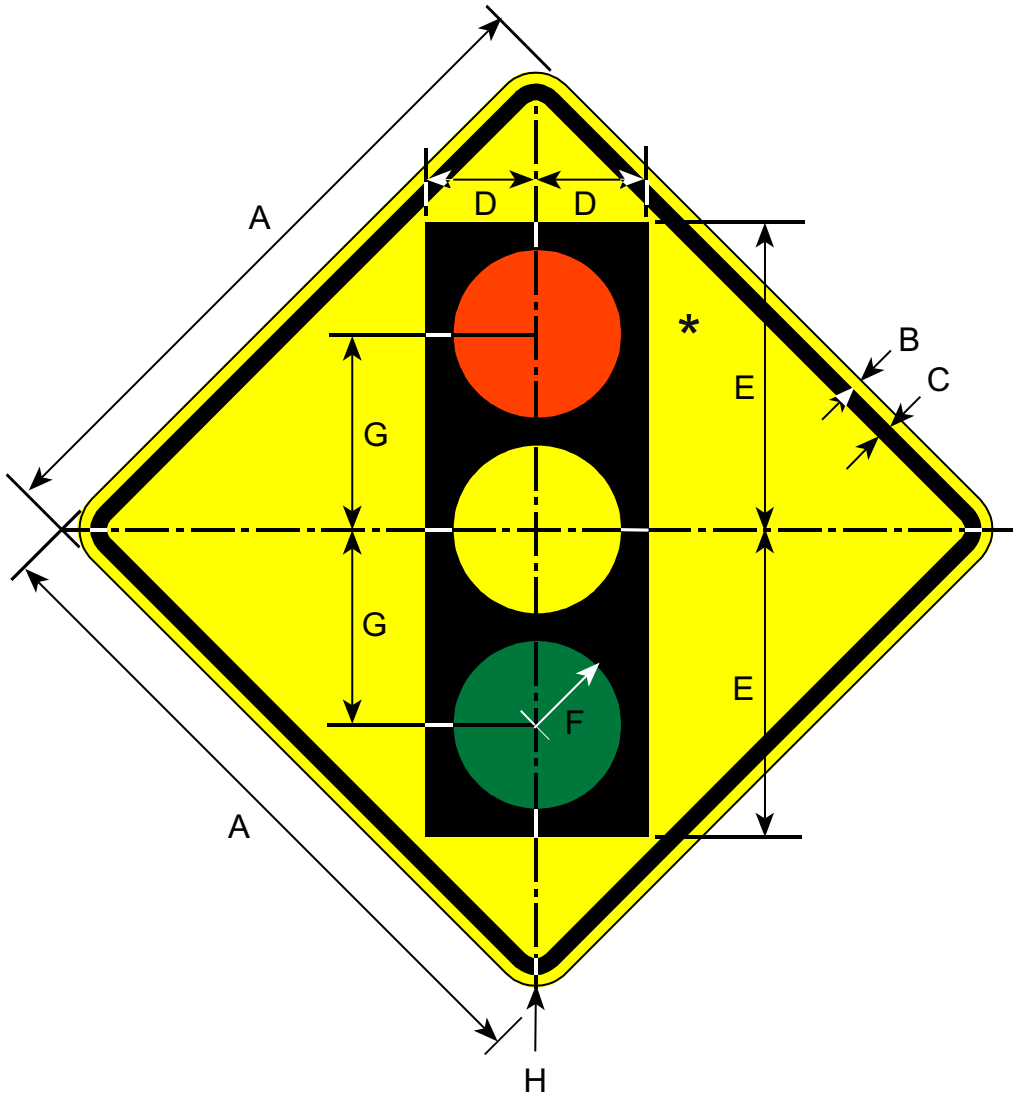

Border and Legend: Black
 Top Circle: Red
 Middle Circle: Yellow
 Bottom Circle: Green
 Background: Yellow

Road Class	Dimensions (inches)							
	A	B	C	D	E	F	G	H
Bike	18	0.38	0.63	3.00	8.00	2.25	5.00	1.50
Minimum	30	0.50	0.75	5.00	13.75	3.75	8.75	1.88
Conventiona	36	0.63	0.88	5.75	15.75	4.25	10.00	2.25
Expwy/Fwy	48	0.75	1.25	7.50	20.00	5.00	12.50	3.00

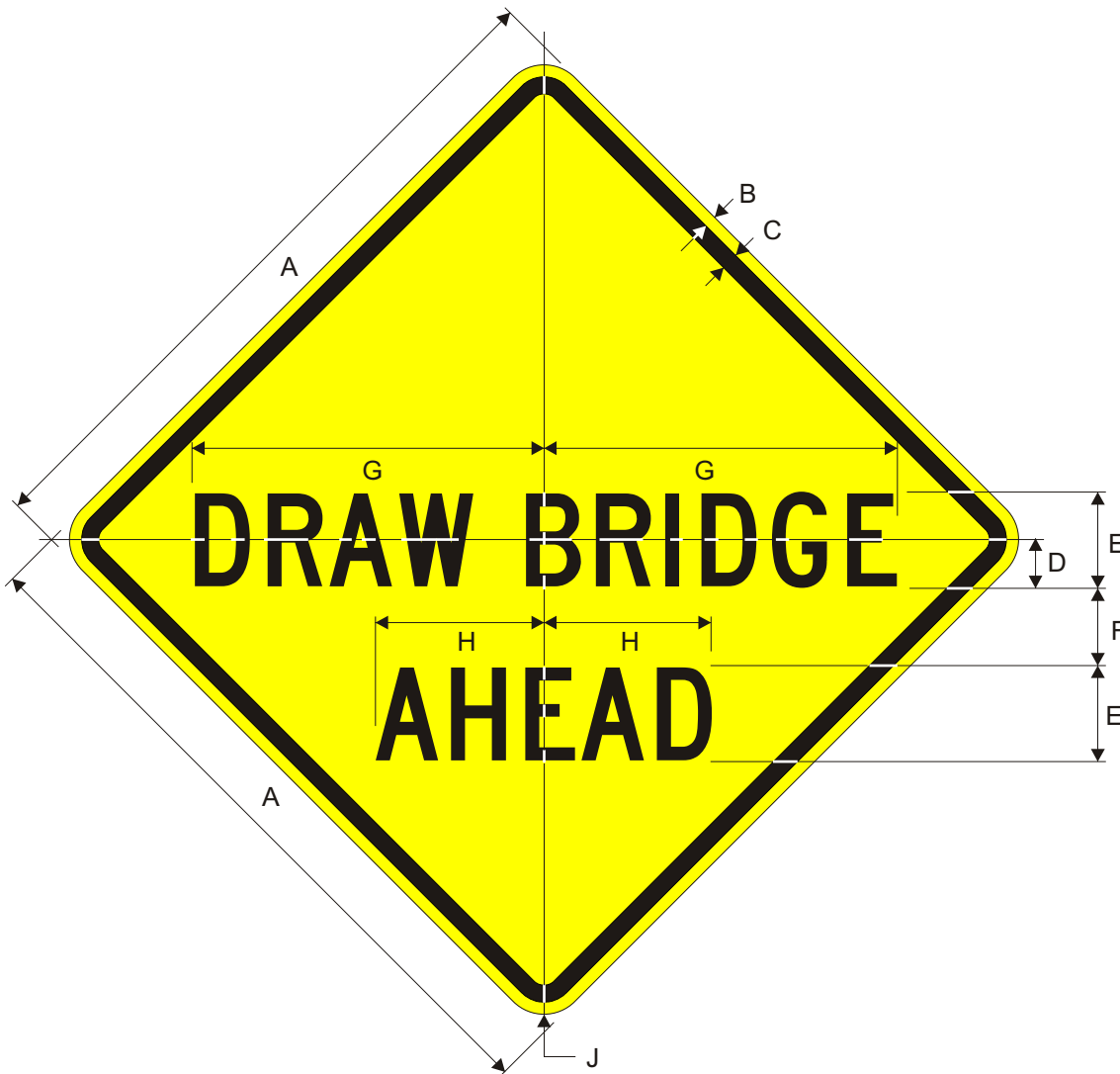

Border and Legend: Black
Background: Yellow

Road Class	Dimensions (inches)								
	A	B	C	D	E	F	G	H	J
Conventional	36	0.63	0.88	2.5	5C	4.0	18.27	8.71	2.25
Expy/Fwy	48	0.75	1.25	3.5	7C	6.0	25.58	12.20	3.0
Oversized	60	0.75	1.25	4.5	9C	8.0	32.89	15.69	3.0

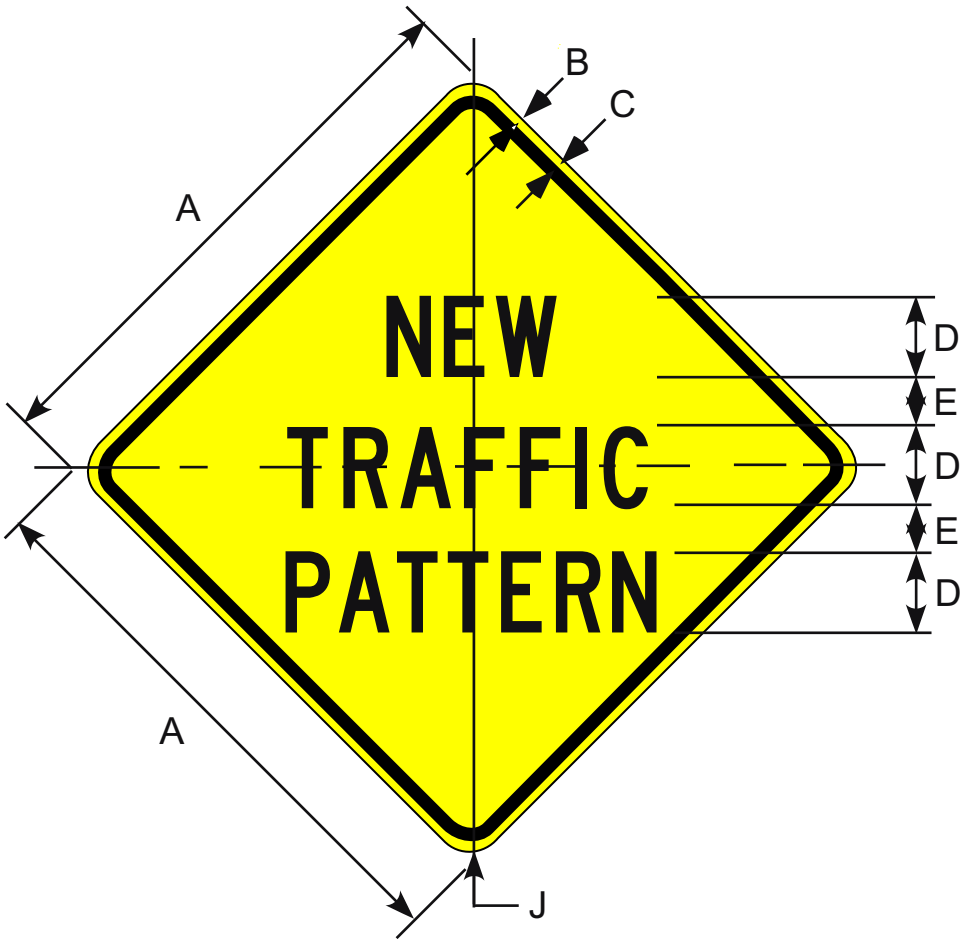

Border and Legend: Black
 Background: Yellow

Road Class	Dimensions (inches)					
	A	B	C	D	E	J
Minimum	30	0.50	0.75	4C	2.50	1.88
Conventional	36	0.63	0.88	5C	3.00	2.25
Expwy/Fwy	48	0.75	1.25	7C	4.00	3.00

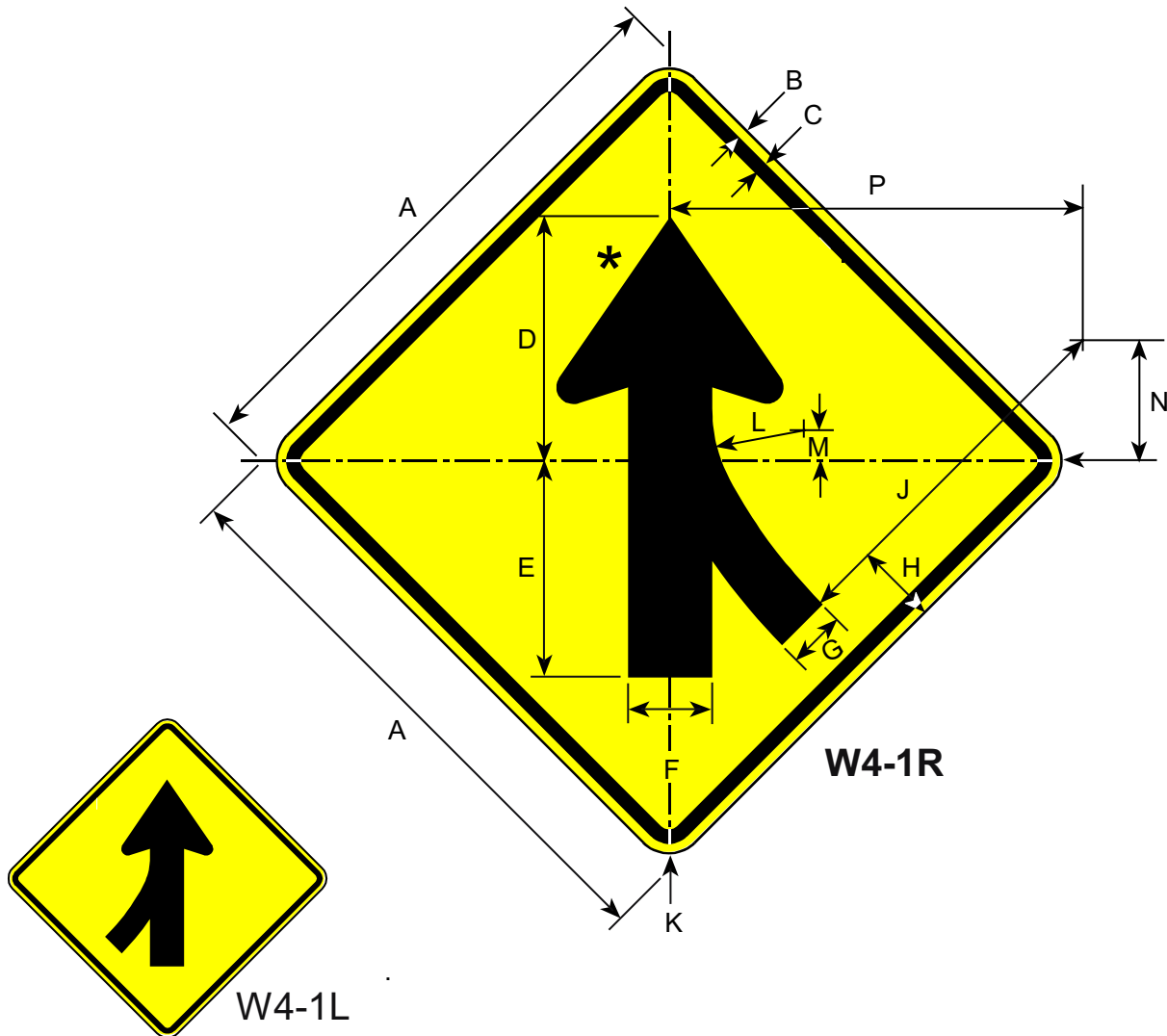

Border and Legend: Black
Background: Yellow

* See Appendix B-1 for Standard Arrow Details.

Road Class	Dimensions (inches)														
	A	B	C	D	E	F	G	H	J	K	L	M	N	P	
Bike	24	0.38	0.63	10.25	8.75	3.5	2.38	4.19	22.25	1.5	6.38	2.63	10.38	22.19	
Minimum	30	0.50	0.75	13	11	4.38	3.0	5.25	28	1.88	8.0	3.0	13	27.75	
Conventional	36	0.63	0.88	15.75	13.25	5.25	3.63	6.31	33.63	2.25	9.63	4.0	15.63	35.31	
Expwy/Fwy	48	0.75	1.25	20.5	17.5	7.0	4.75	8.38	45	3.0	12.81	5.25	20.75	44.38	

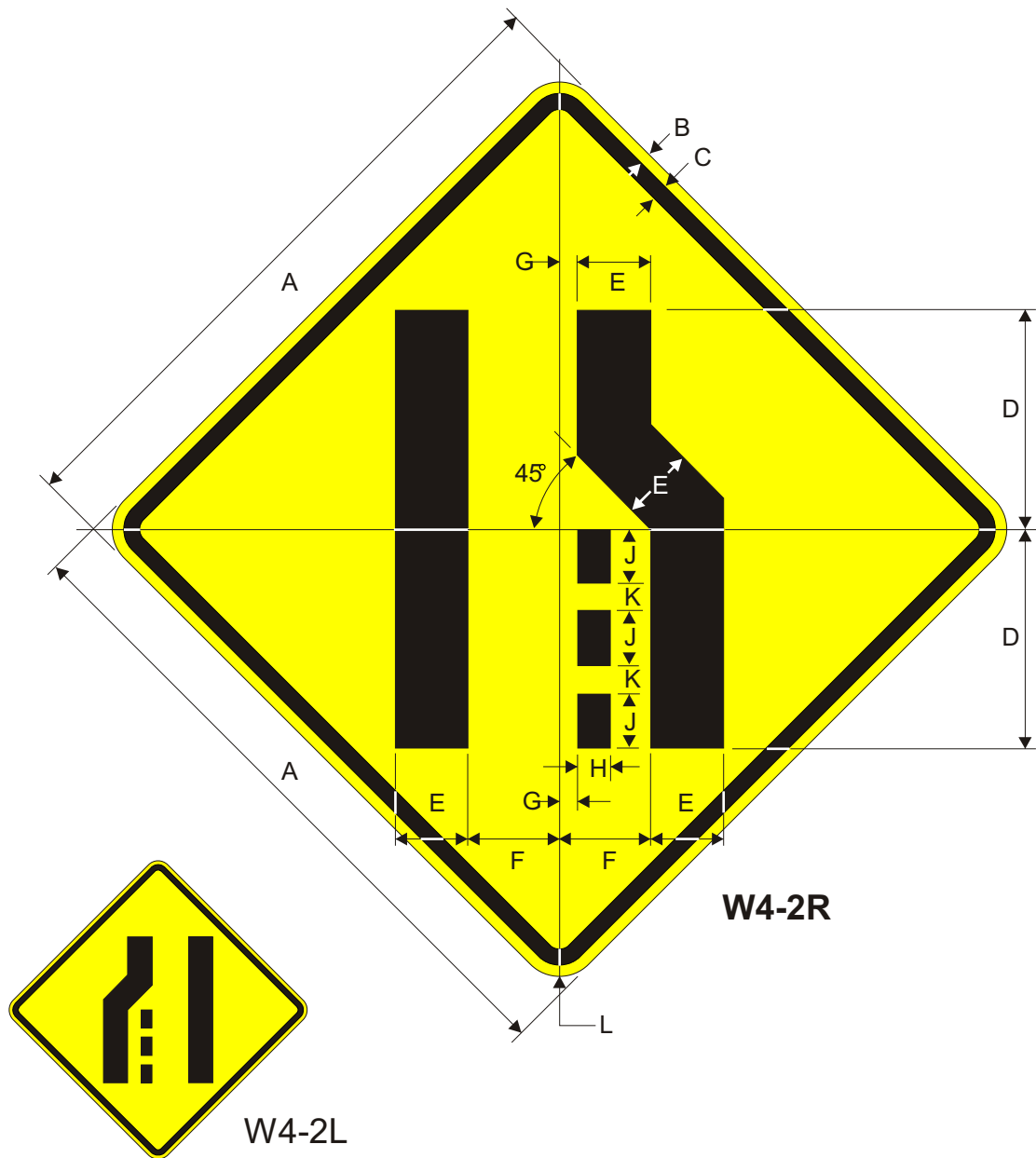

Border and Legend: Black
Background: Yellow

Road Class	Dimensions (inches)										
	A	B	C	D	E	F	G	H	J	K	L
Min.	30	0.50	0.75	10	3.38	4.19	0.88	1.5	2.5	1.25	1.88
Conv.	36	0.63	0.88	12	4.0	5.0	1.0	1.75	3.0	1.5	2.25
Expy/Fwy	48	0.75	1.25	16	5.38	6.69	1.25	2.38	4.0	2.0	3.0

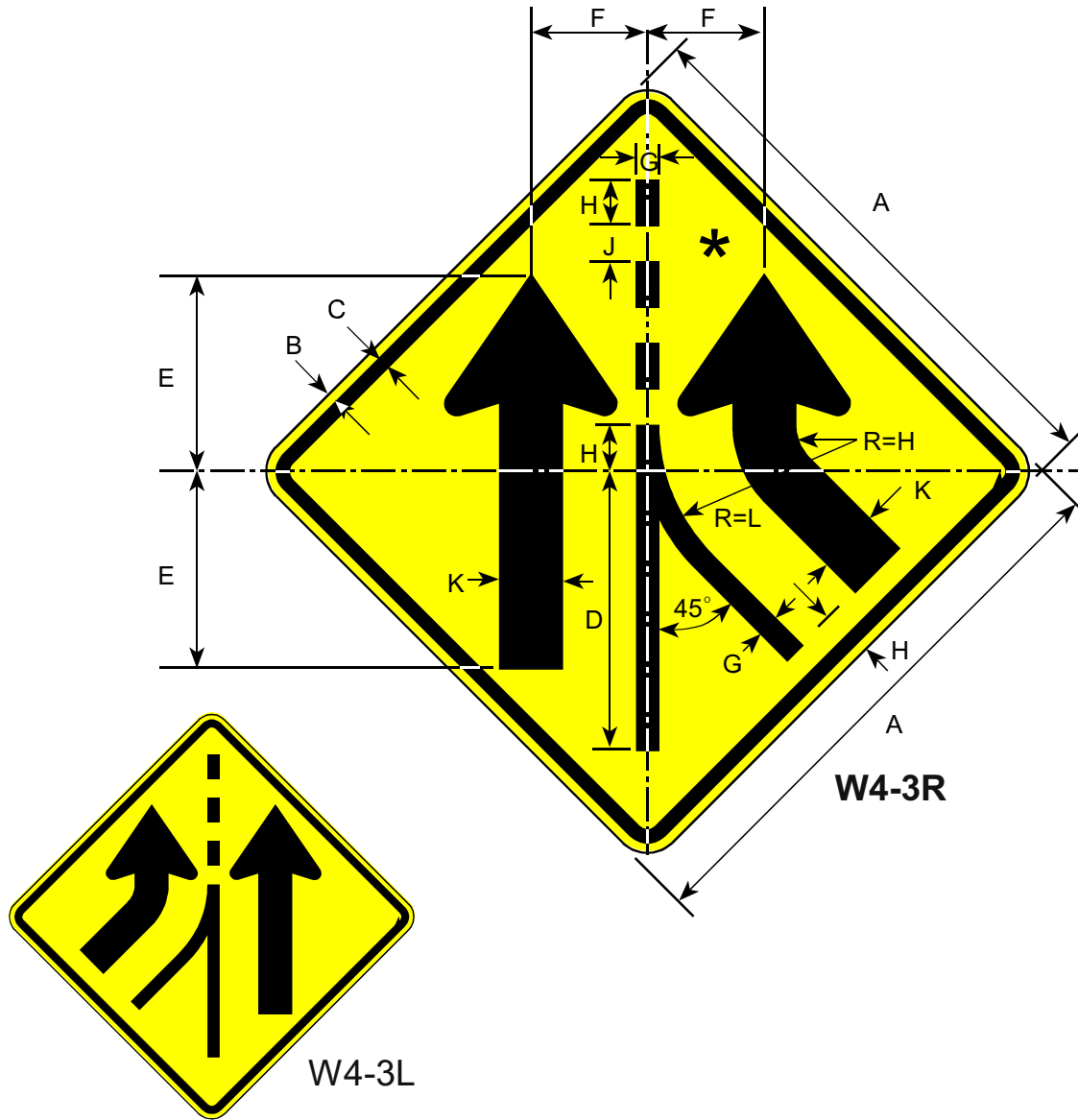

Border and Legend: Black
Background : Yellow

* See Appendix B-1 for Standard Arrow Details.

Road Class	Dimensions (inches)										
	A	B	C	D	E	F	G	H	J	K	L
Expwy/Fwy	48	0.75	1.25	24	17	10	2.0	4.0	3.0	5.5	15.75

W4-4P
W4-4A
W4-4B



W4-4P



W4-4A



W4-4B

Shall only be used with R1-1 "Stop Sign"

Border and Legend: Black
Background: Yellow

Road Class	Dimensions (inches)												
	A	B	C	D	E	F	G	H	J	K	L	M	N
Min.	24	12	0.38	0.63	3.0	2.25C	1.5	9.31	9.63	2.25B	10.11	9.78	1.5
Conv.	30	15	0.50	0.75	3.5	3C	2.0	12.42	12.42	3B	12.9	13.04	1.88
Expy.	36	18	0.63	0.88	4.0	3.5C	3.0	14.49	14.98	3.5B	15.72	15.21	2.25
Oversized	48	24	0.75	1.25	5.5	4.5C	4.0	18.63	19.26	4.5B	20.21	19.56	3.0

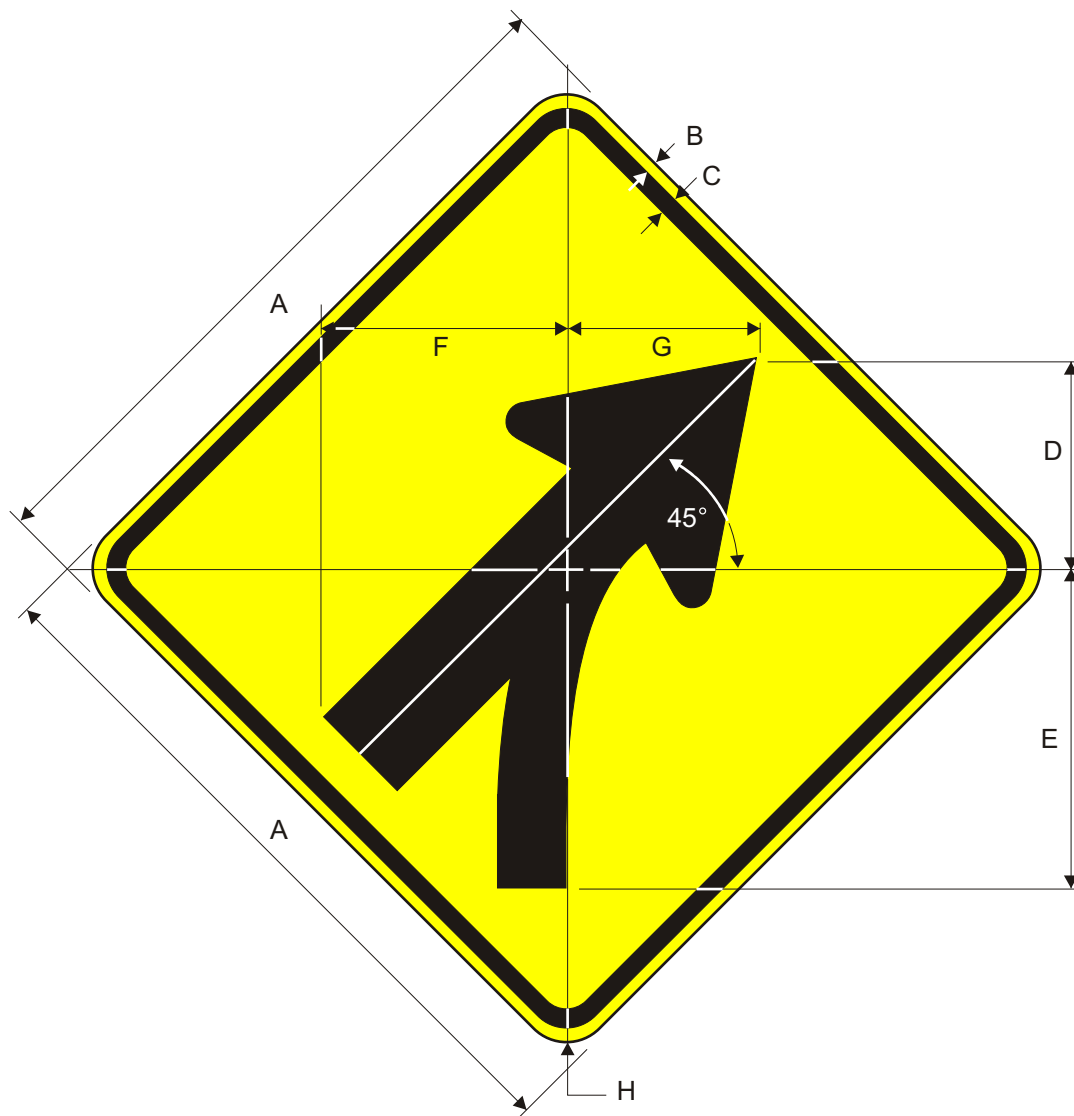

Scale and rotate W4-1 to fit dimensions.

Border and Legend: Black
Background: Yellow

Road Class	Dimensions (inches)							
	A	B	C	D	E	F	G	H
Min.	30	0.5	0.75	9.13	13.77	10.45	8.17	1.88
Conv.	36	0.63	0.88	10.93	16.53	12.57	9.81	2.25
Expy/Fwy	48	0.75	1.25	14.57	22	16.73	16.05	3.0

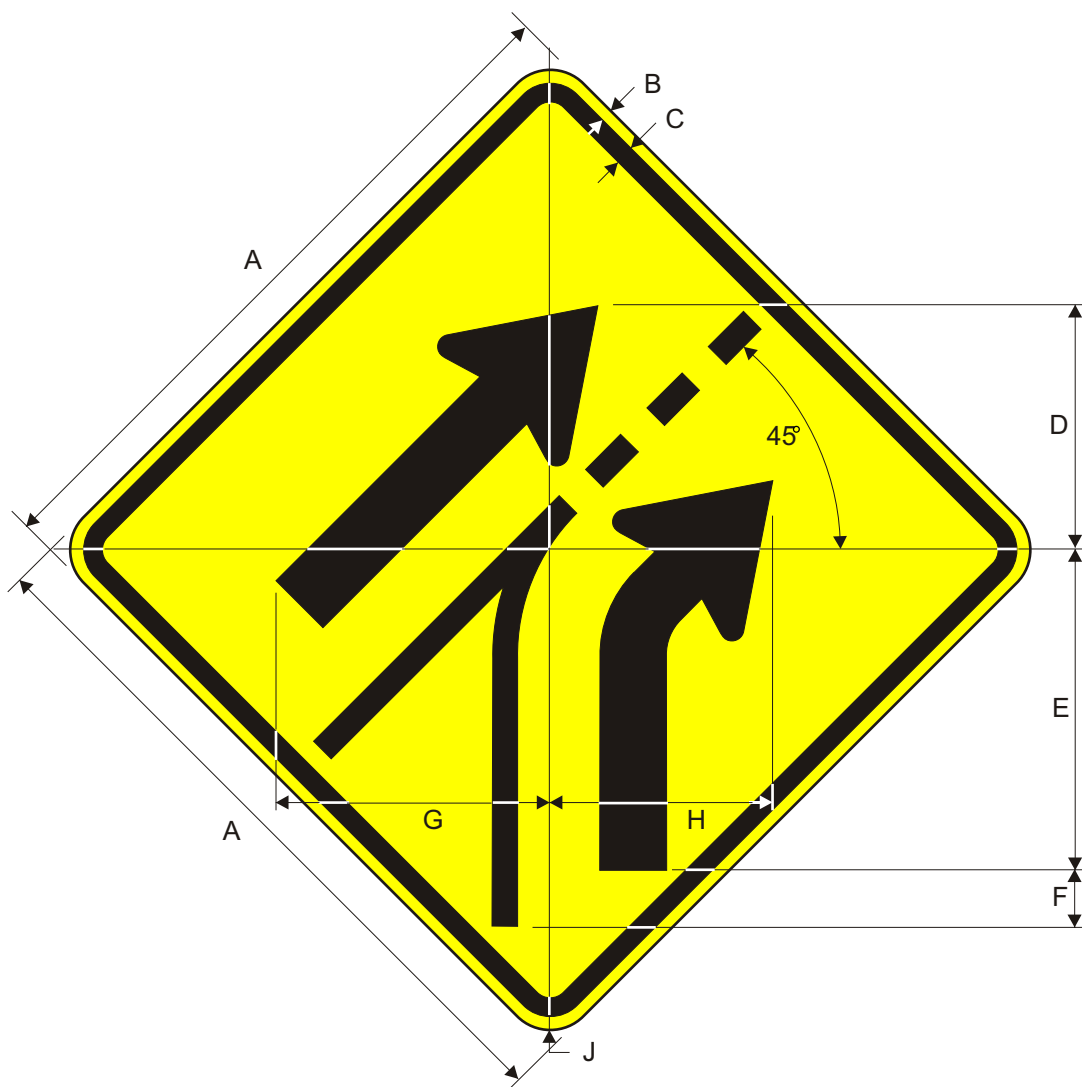

Scale and rotate W4-3 to fit dimensions.

Border and Legend: Black
Background: Yellow

Road Class	Dimensions (inches)								
	A	B	C	D	E	F	G	H	J
Min.	30	0.5	0.75	12.97	13.41	15.69	14.57	11.21	1.88
Conv.	36	0.63	0.88	15.57	16.09	18.81	17.49	13.45	2.25
Expy/Fwy	48	0.75	1.25	20.74	21.46	25.14	23.30	17.93	3.0

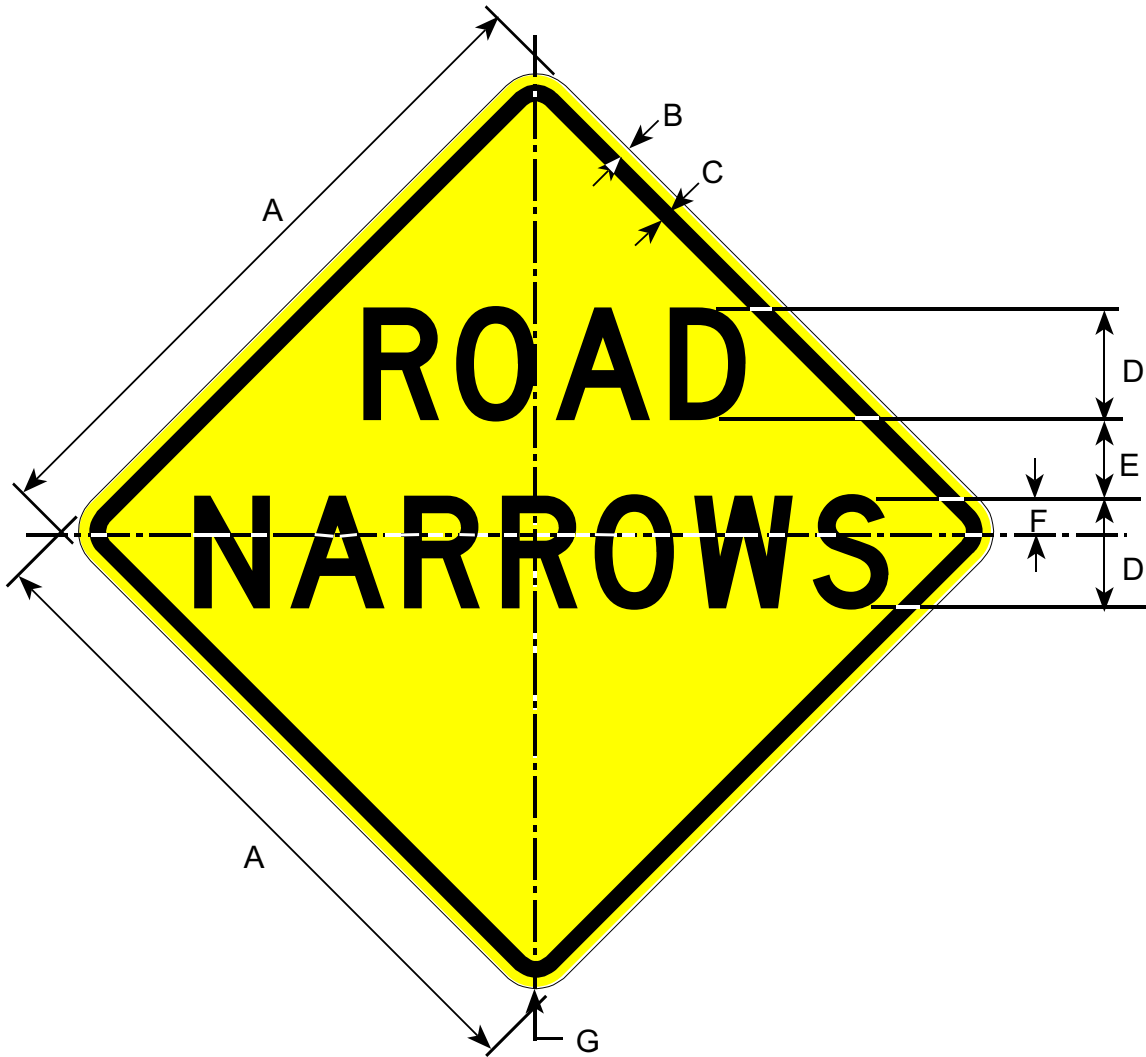

Border and Legend: Black
Background: Yellow

Road Class	Dimensions (inches)						
	A	B	C	D	E	F	G
Minimum	30	0.50	0.75	5D	3.0	1.75	1.88
Conventional	36	0.63	0.88	6D	3.5	2.00	2.25
Expwy/Fwy	48	0.75	1.25	8D	4.0	3.00	3.00

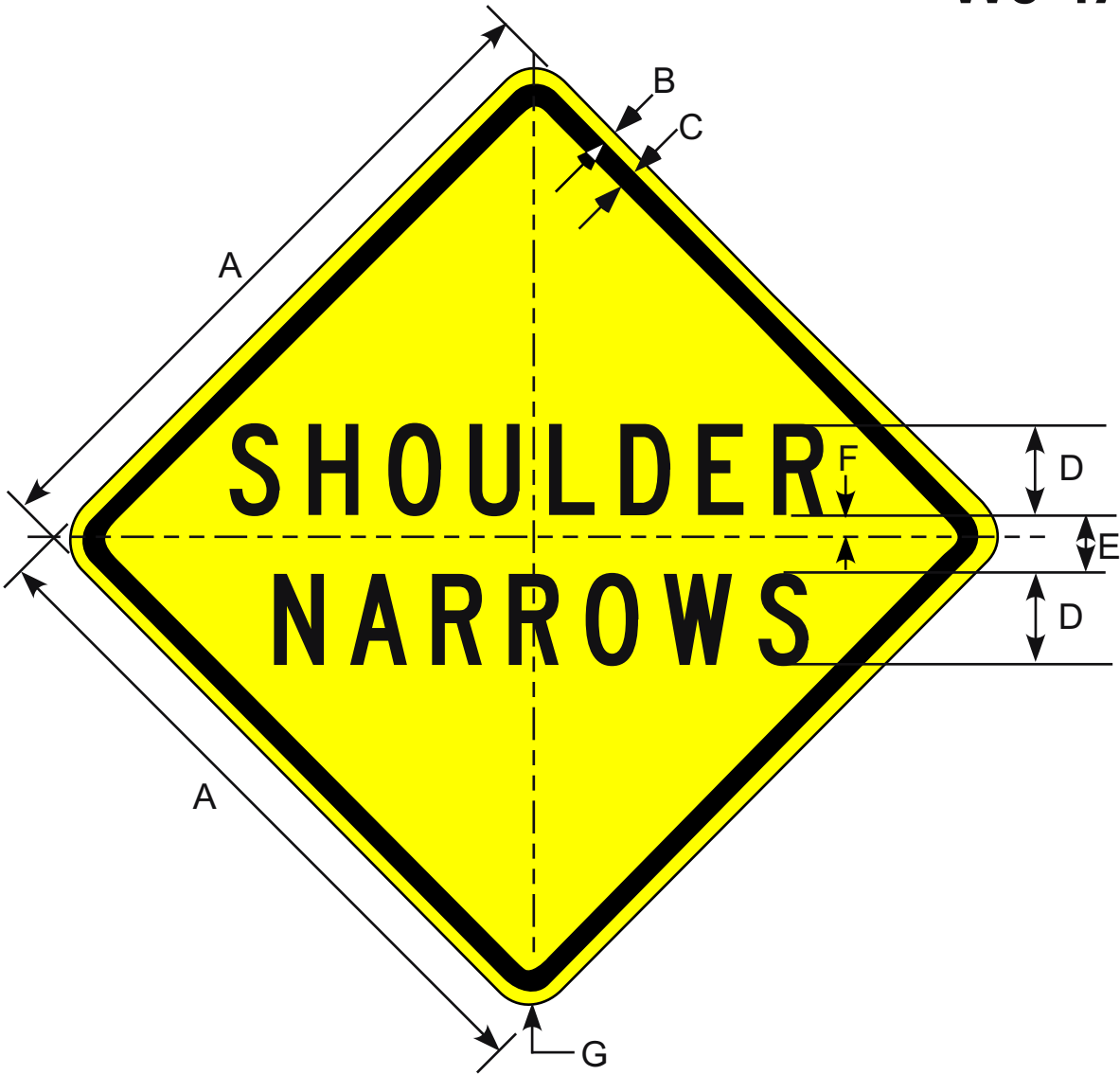

Border and Legend: Black
Background: Yellow

Road Class	Dimensions (inches)						
	A	B	C	D	E	F	G
Minimum	30	0.50	0.75	4C	3.0	1	1.88
Conventional	36	0.63	0.88	5C	3.5	1	2.25
Expwy/Fwy	48	0.75	1.25	7C	4.5	2	3.00

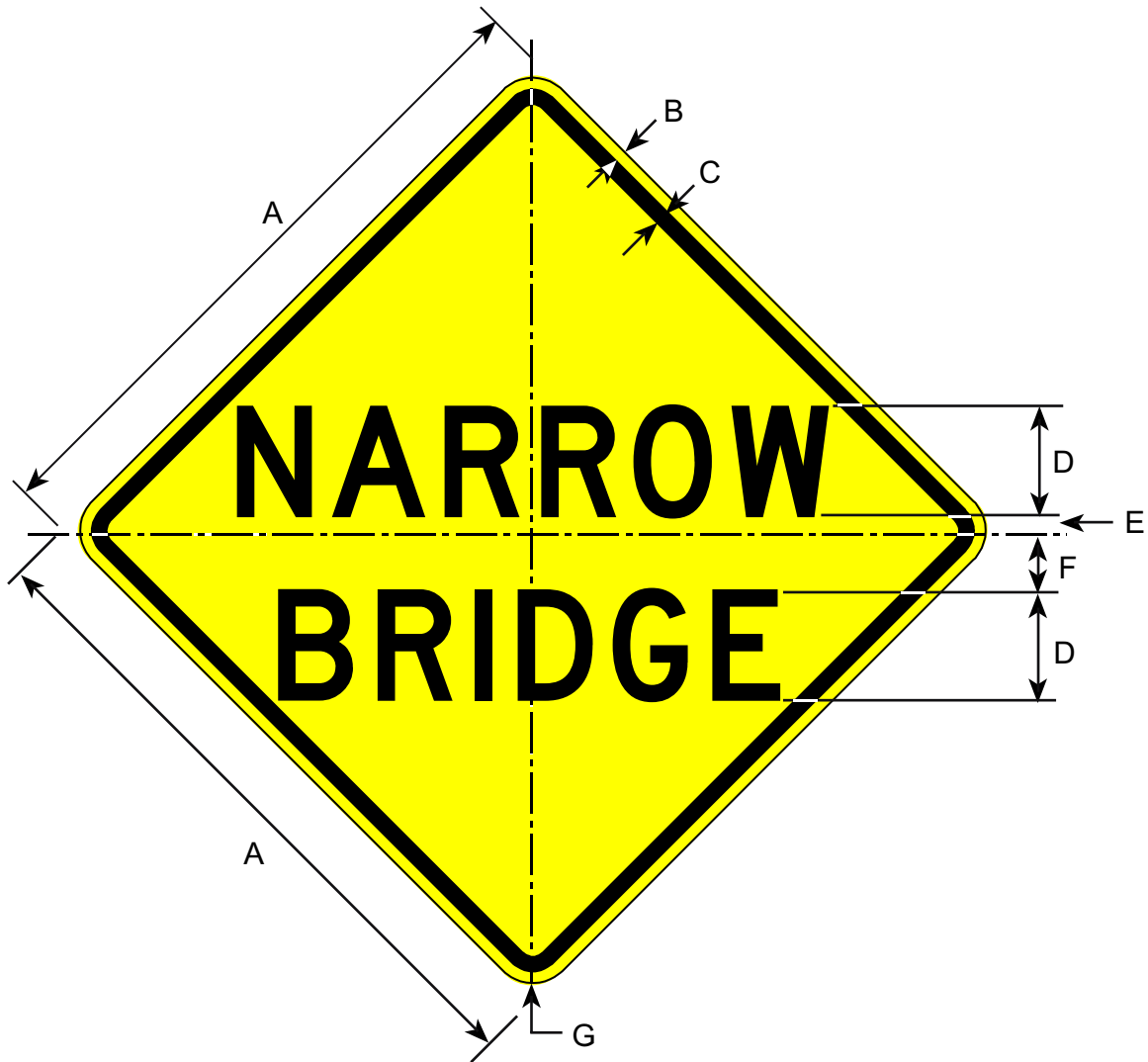

Border and Legend: Black
Background: Yellow

Road Class	Dimensions (inches)						
	A	B	C	D	E	F	G
Minimum	30	0.50	0.75	5D	0.50	2.5	1.88
Conventional	36	0.63	0.88	6D	0.75	3.0	2.25
Expwy/Fwy	48	0.75	1.25	8D	1.25	4.0	3.00

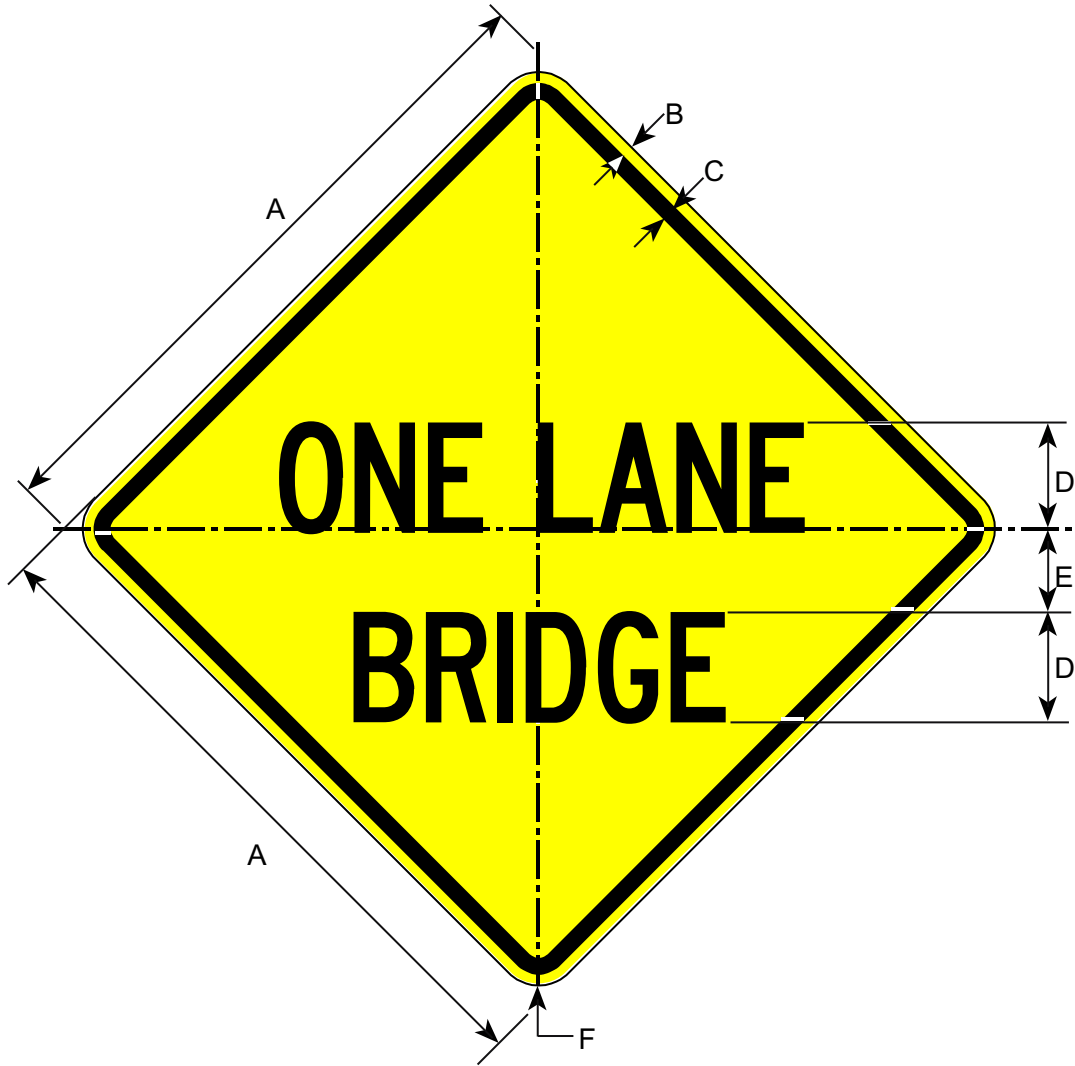

Border and Legend: Black
Background: Yellow

Road Class	Dimensions (inches)					
	A	B	C	D	E	F
Minimum	30	0.50	0.75	5C	3.25	1.88
Conventional	36	0.63	0.88	6C	4.00	2.25
Expwy/Fwy	48	0.75	1.25	8C	5.00	3.00

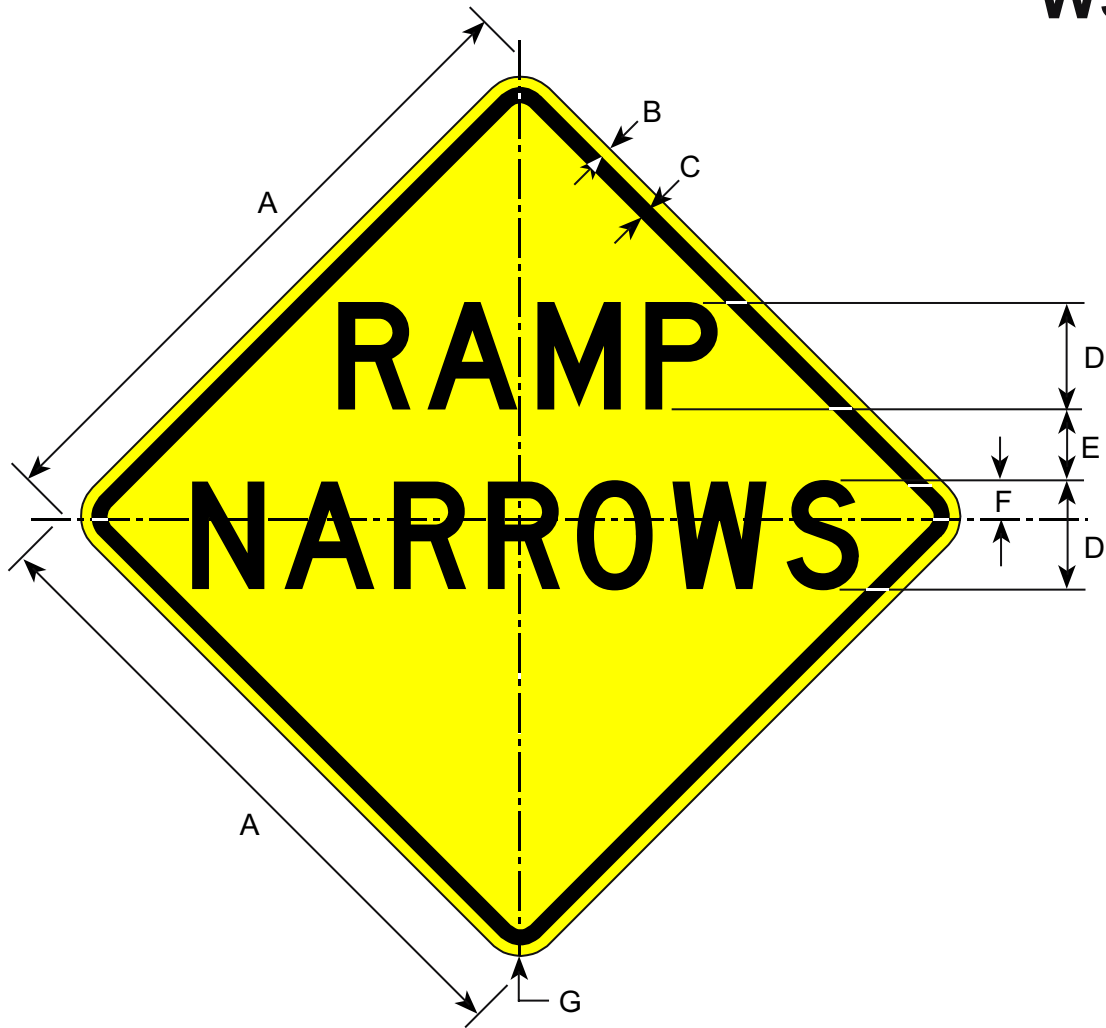

Border and Legend: Black
Background: Yellow

Road Class	Dimensions (inches)						
	A	B	C	D	E	F	G
Minimum	30	0.50	0.75	5D	3.0	1.75	1.88
Conventional	36	0.63	0.88	6D	3.5	2.00	2.50
Expwy/Fwy	48	0.75	1.50	8D	4.0	3.00	3.00



Border and Legend: Black
Background: Yellow

Road Class	Dimensions (inches)								
	A	B	C	D	E	F	G	H	J
Shared Use Path	18	0.38	0.63	0.63	3C	1.0	6.85	7.53	1.5
Roadway	30	0.5	0.75	1.0	5C	1.81	11.41	12.55	1.88

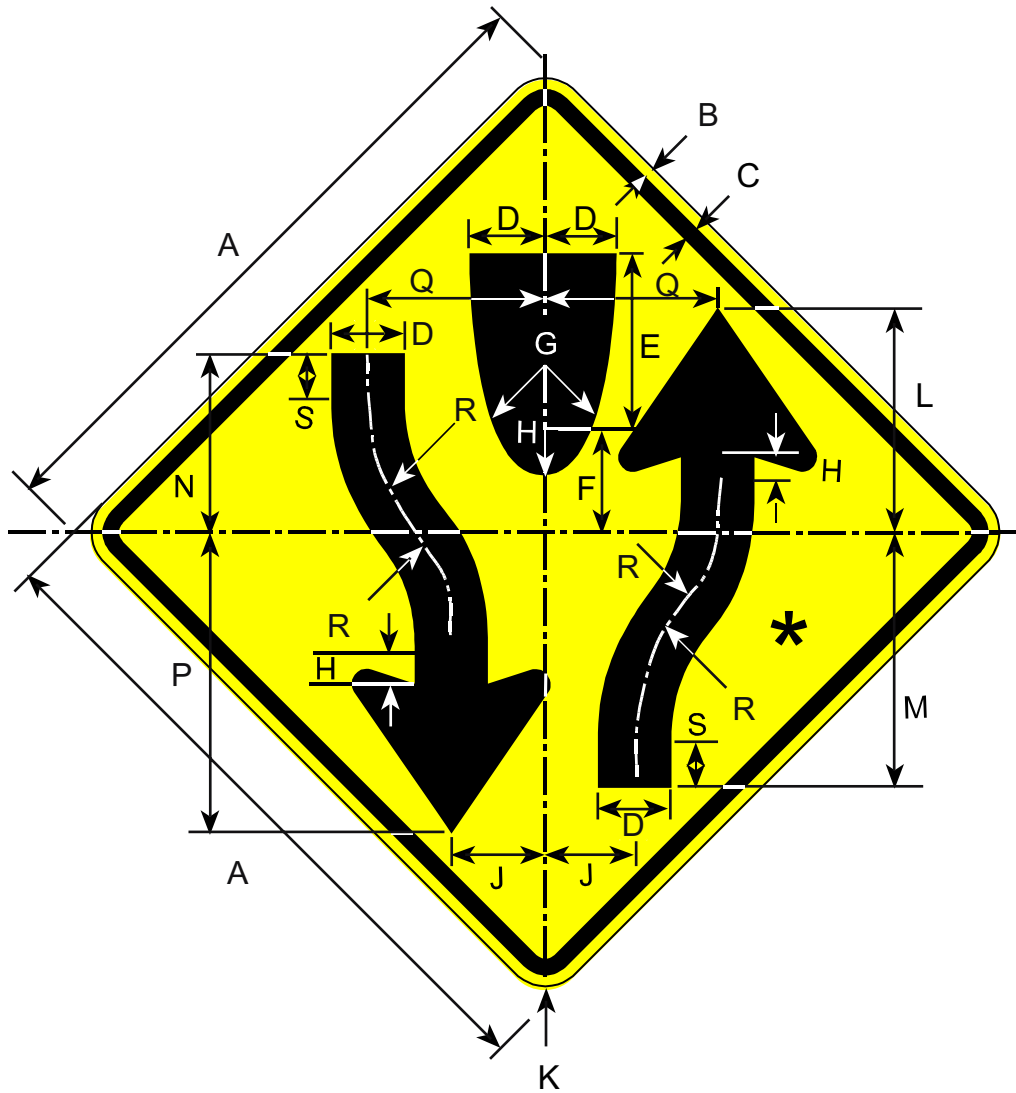

Border and Legend: Black
Background: Yellow

* See Appendix B-1 for Standard Arrow Details.

Road Class	Dimensions (inches)										
	A	B	C	D	E	F	G	H	J	K	L
Minimum	30	0.50	0.75	3.31	8.31	4.13	25	1.69	4.13	1.88	10
Conventional	36	0.63	0.88	4.0	10	5.0	30	2.0	5.0	2.25	12
Expwy/Fwy	48	0.75	1.25	5.25	13.13	6.56	39.31	2.63	6.56	3.0	16

M	N	P	Q	R	S
11.63	7.94	13.69	7.88	8.31	2.06
14	9.5	16.5	9.5	10	2.5
18.69	12.69	22	12.44	13.13	3.31

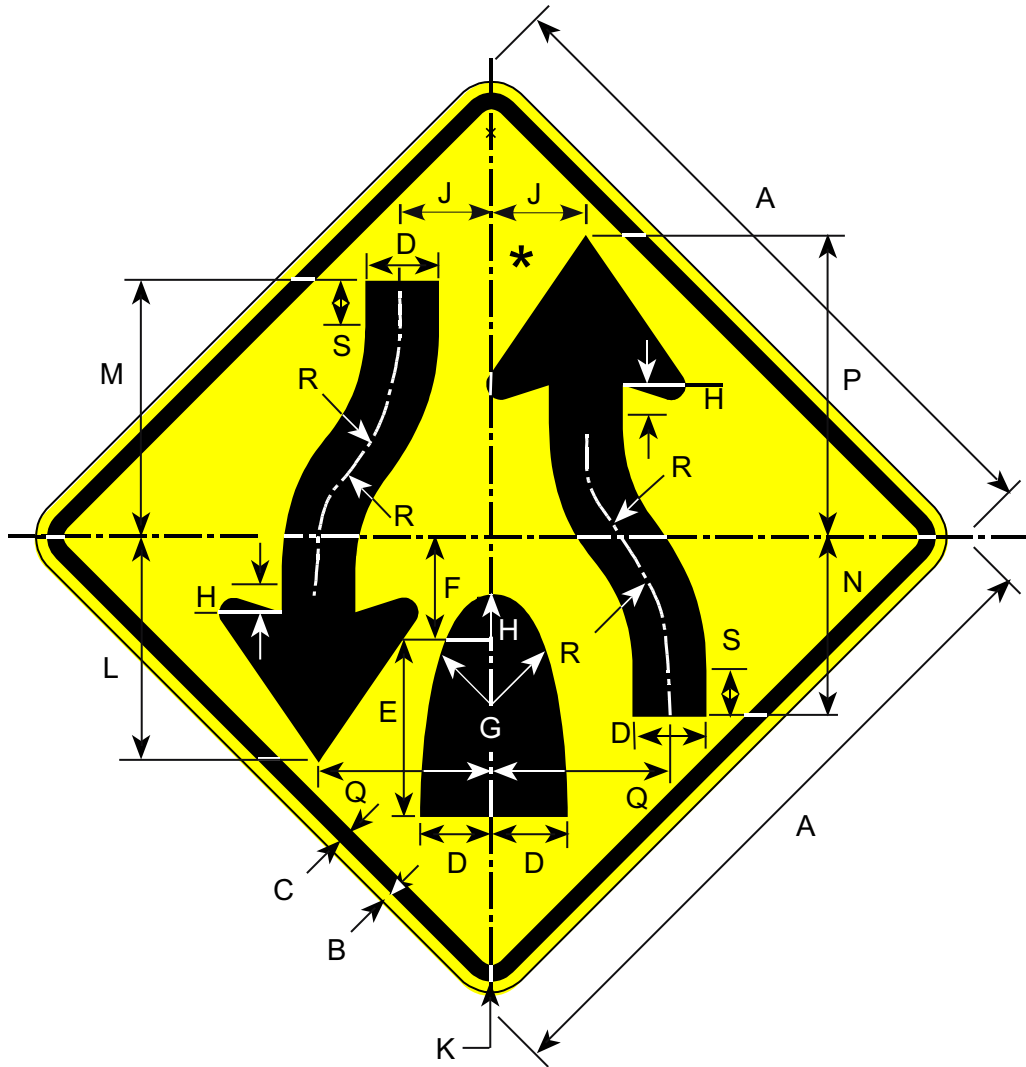

Border and Legend: Black
Background: Yellow

* See Appendix B-1 for Standard Arrow Details.

Road Class	Dimensions (inches)										
	A	B	C	D	E	F	G	H	J	K	L
Minimum	30	0.5	0.75	3.31	8.31	4.13	25	1.0	4.13	1.88	10
Conventional	36	0.63	0.88	4.0	10	5.0	30	2.0	5.0	2.25	12
Expwy/Fwy	48	0.75	1.25	5.25	13.13	6.56	39.31	2.63	6.56	3.0	16
	M	N	P	Q	R	S					
	11.63	7.94	13	7.88	8.31	2.06					
	14	9.5	16.5	9.5	10	2.5					
	18.69	12.69	22	12.44	13.13	3.31					

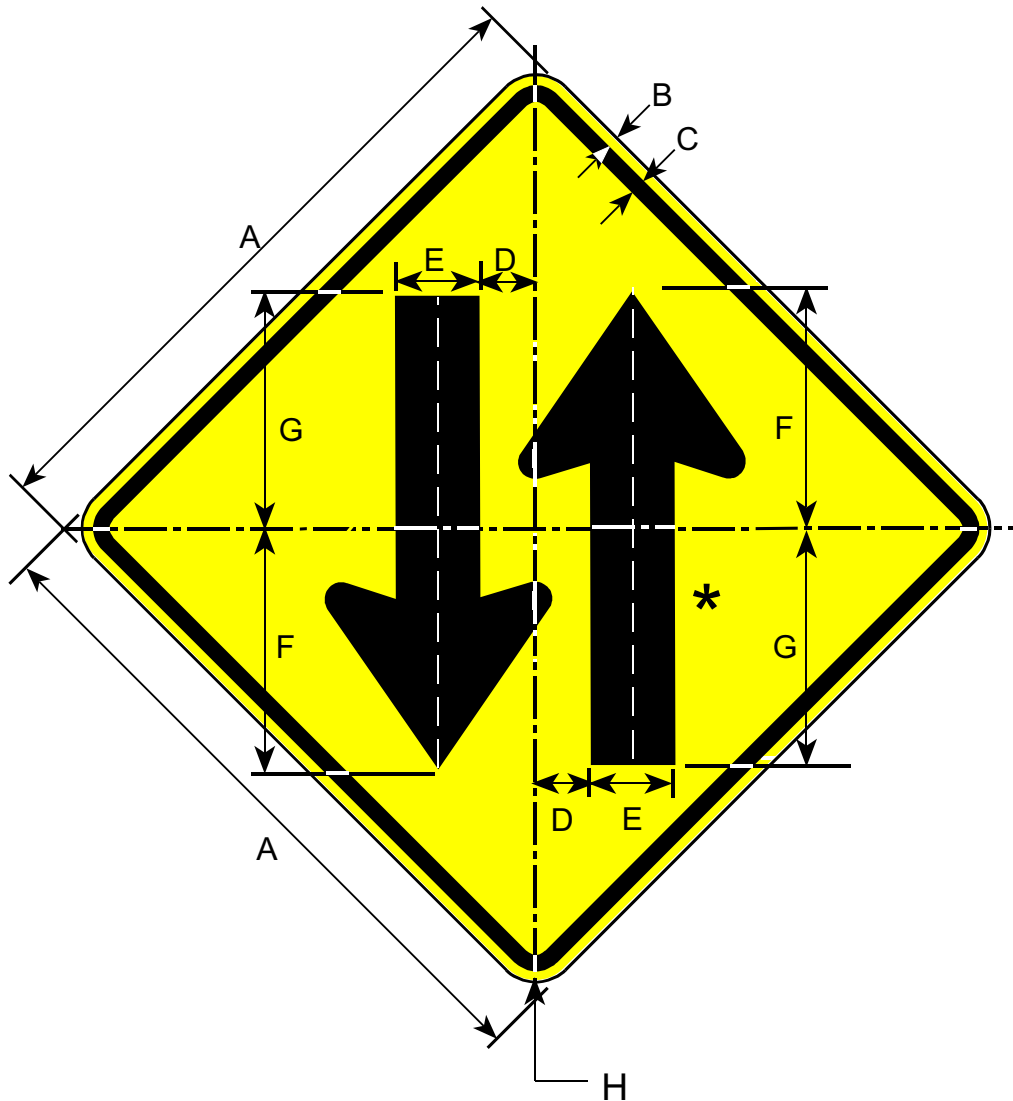

Border and Legend: Black
Background: Yellow

* See Appendix B-1 for Standard Arrow Details.

Road Class	Dimensions (inches)							
	A	B	C	D	E	F	G	H
Minimum	30	0.50	0.75	2.44	3.75	11	10.63	1.88
Conventional	36	0.63	0.88	2.94	4.5	13.5	12.75	2.25
Expwy/Fwy	48	0.75	1.5	3.88	6.0	18	17	3.0

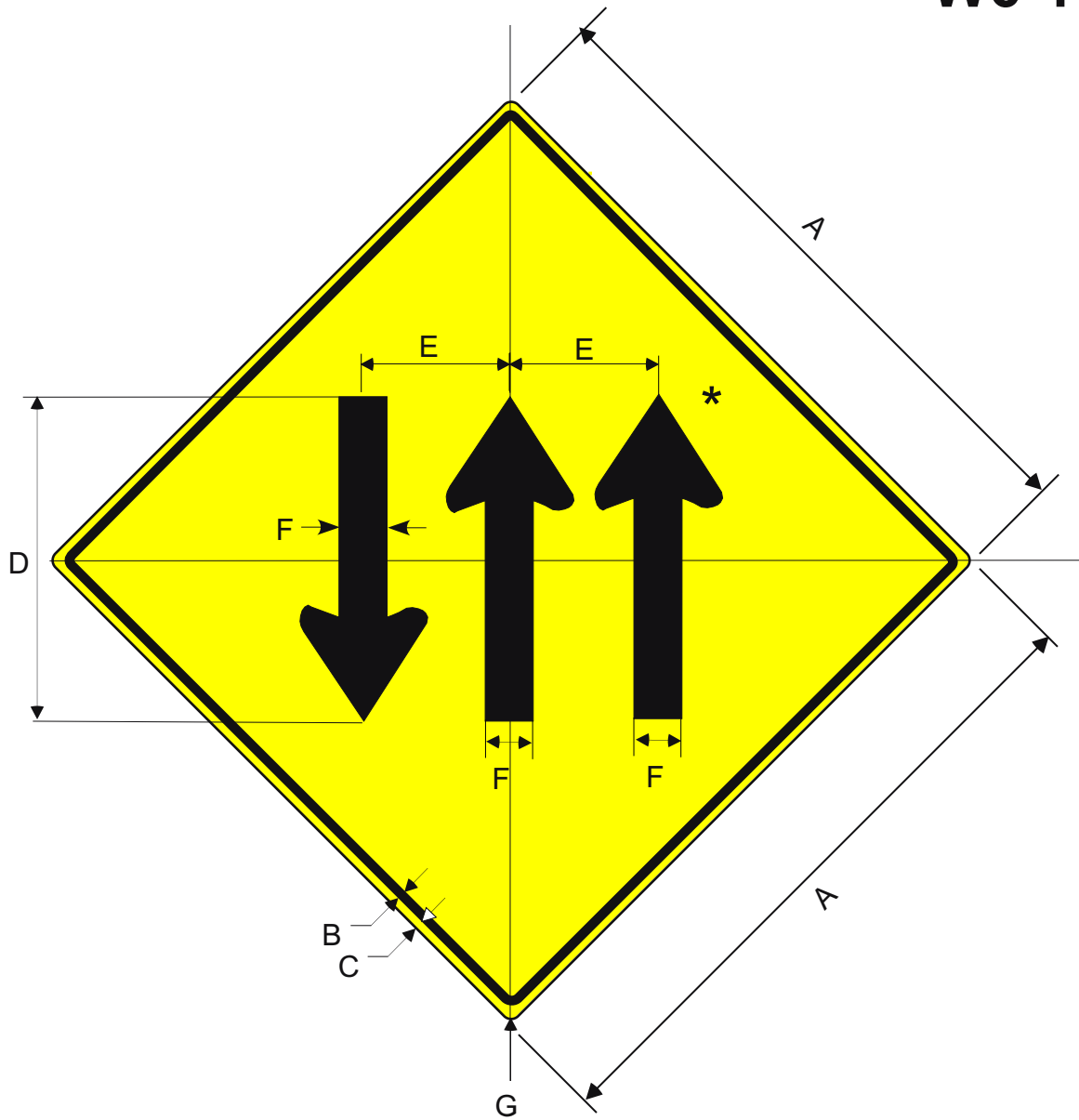

Border and Legend: Black
Background: Yellow

* See Appendix B-1 for Standard Arrow Details.

Prior to the 2002 publication of this manual, this sign was numbered W6-4(1-2).

Road Class	Dimensions (inches)						
	A	B	C	D	E	F	G
Conventional	36	0.63	0.88	22	8.0	2.75	2.25
Expwy/Fwy	48	0.75	1.25	30	11	3.5	3.0

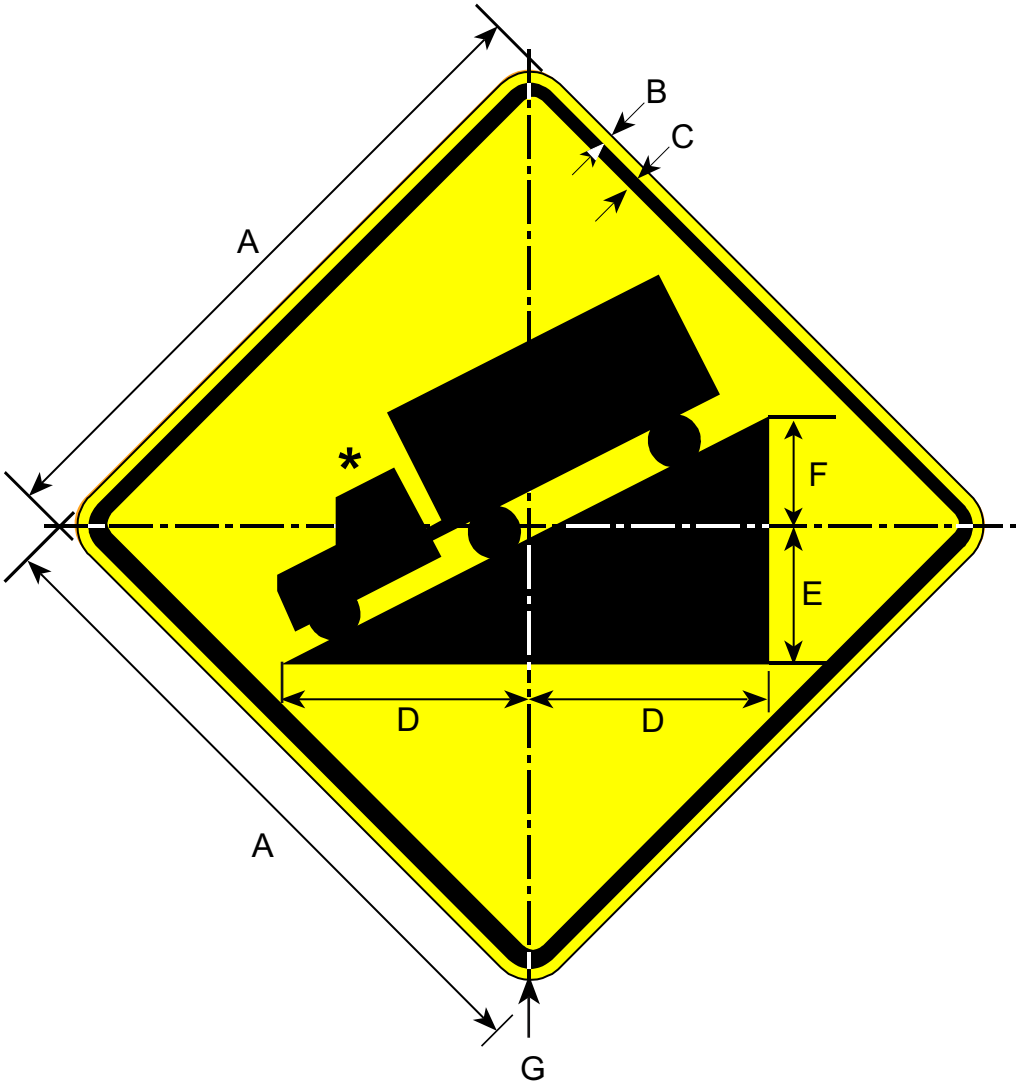

*Make symbol proportional to the graphic shown.

Border and Legend: Black
Background: Yellow

Road Class	Dimensions (inches)						
	A	B	C	D	E	F	G
Minimum	30	0.50	0.75	11	7.50	6.55	1.88
Conventional	36	0.63	0.88	13.25	9.0	7.85	2.25
Expwy/Fwy	48	0.75	1.25	17.5	12	10.48	3.0

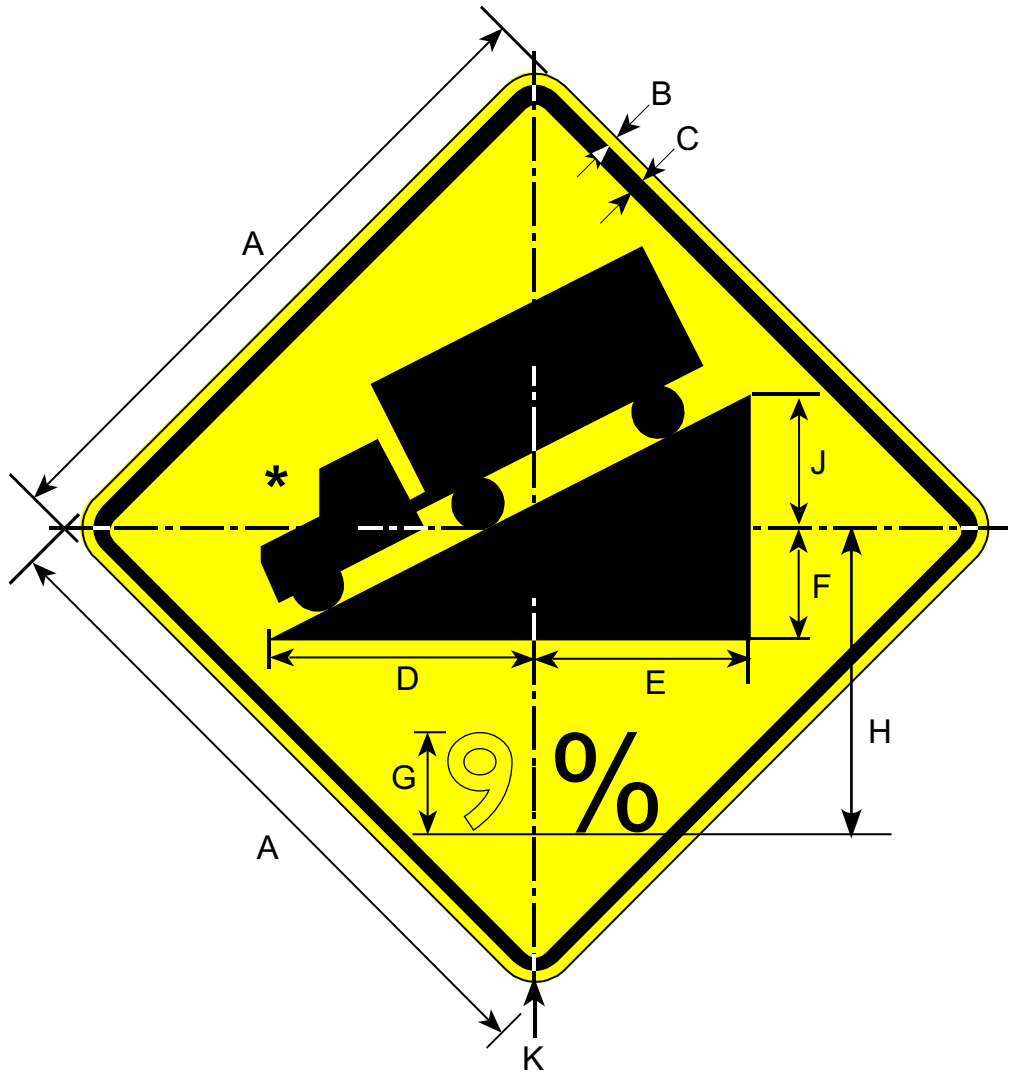

*Make symbol proportional to the graphic shown.

Border and Legend: Black
Background: Yellow

Road Class	Dimensions (inches)									
	A	B	C	D	E	F	G	H	J	K
Minimum	30	0.50	0.75	12.75	9.25	5.0	5D	12.5	6.0	1.88
Conventional	36	0.63	0.88	15.38	11.13	6.0	6D	15	7.0	2.25
Expwy/Fwy	48	0.75	1.25	20.5	14.5	8.0	8D	20	9.0	3.0

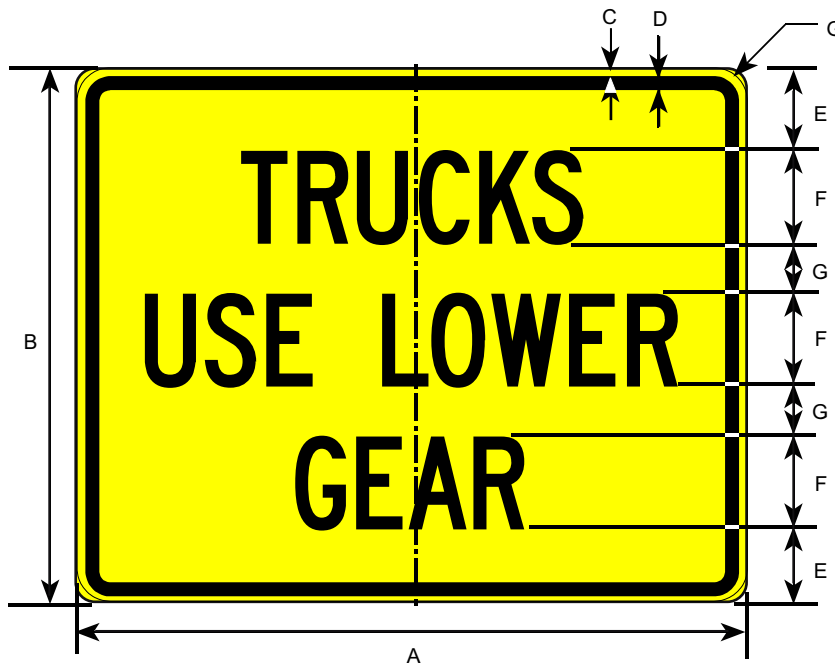

Border and Legend: Black
Background: Yellow

Prior to the 2002 publication of this manual, this sign was numbered W7-2.

Road Class	Dimensions (inches)						
	A	B	C	D	E	F	G
Min. & Conv.	24	18	0.38	0.63	3	3C	1.5

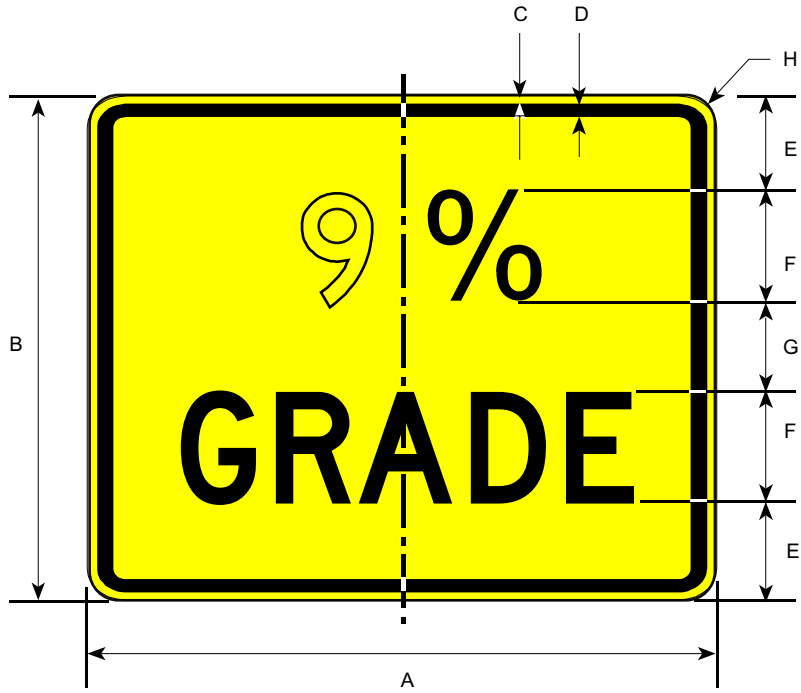

Border and Legend: Black
Background: Yellow

Road Class	Dimensions (inches)							
	A	B	C	D	E	F	G	H
Min. & Conv.	24	18	0.38	0.63	4	4D	2	1.5

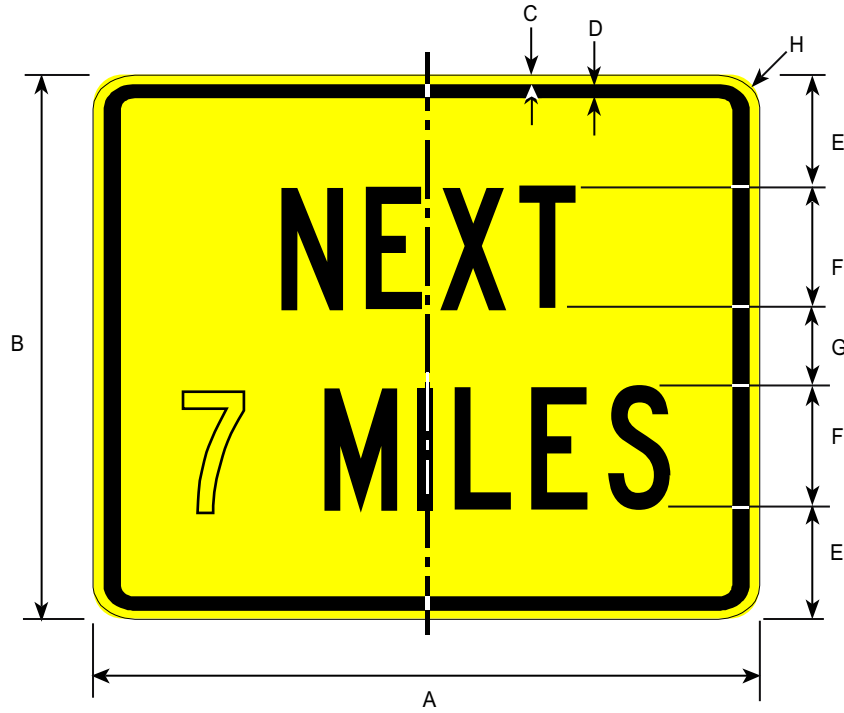

Border and Legend: Black
Background: Yellow

Road Class	Dimensions (inches)							
	A	B	C	D	E	F	G	H
Conv & Min	24	18	0.38	0.63	4	4C	2	1.5

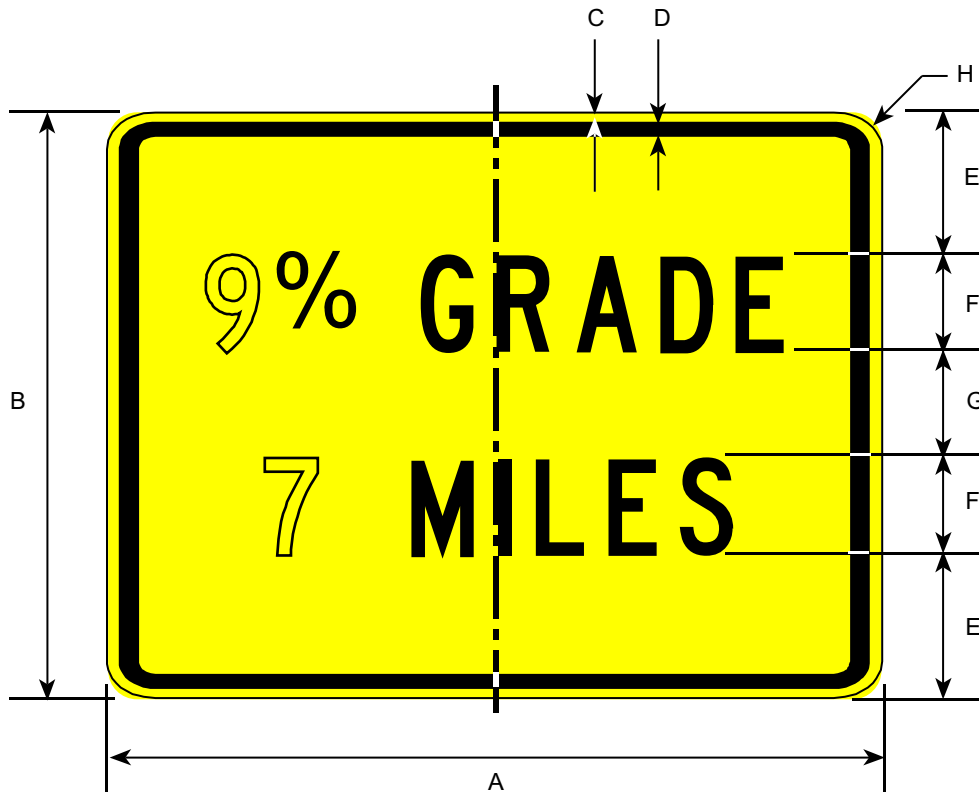

Border and Legend: Black
Background: Yellow

Road Class	Dimensions (inches)							
	A	B	C	D	E	F	G	H
Conv & Min	24	18	0.38	0.63	4	3C	4	1.5

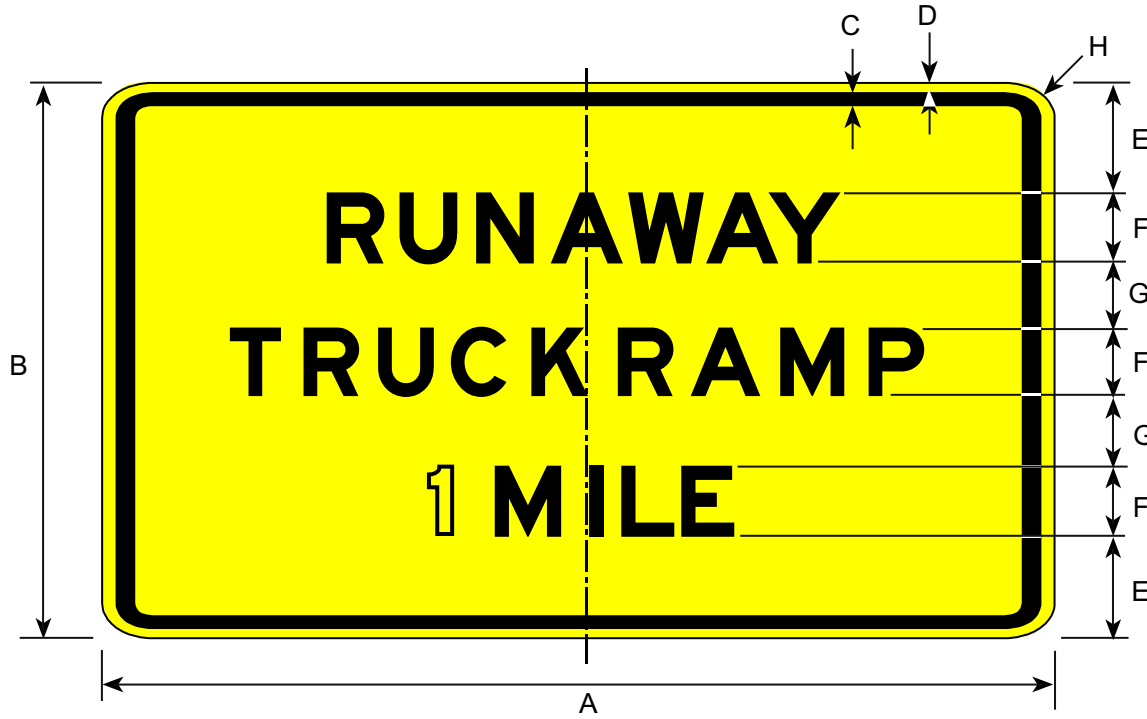

Border and Legend: Black
Background: Yellow

Road Class	Dimensions (inches)							
	A	B	C	D	E	F	G	H
Expwy/Fwy	78	48	1.25	0.75	9	6E	6	3

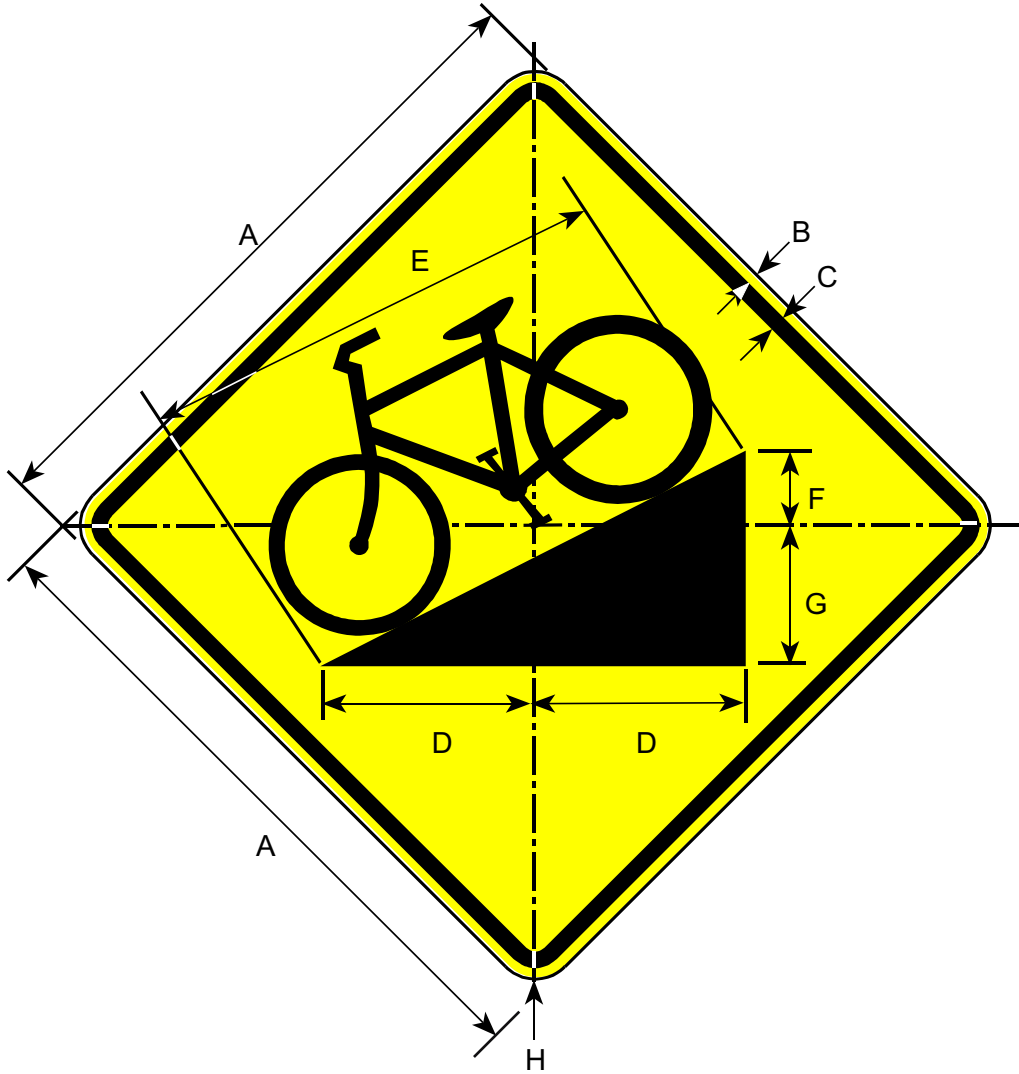

*Make symbol proportional to the graphic shown.

Border and Legend: Black
Background: Yellow

Road Class	Dimensions (inches)							
	A	B	C	D	E	F	G	H
Bike	18	0.38	0.63	5.63	12.63	1.75	4	1.5

W7-4B

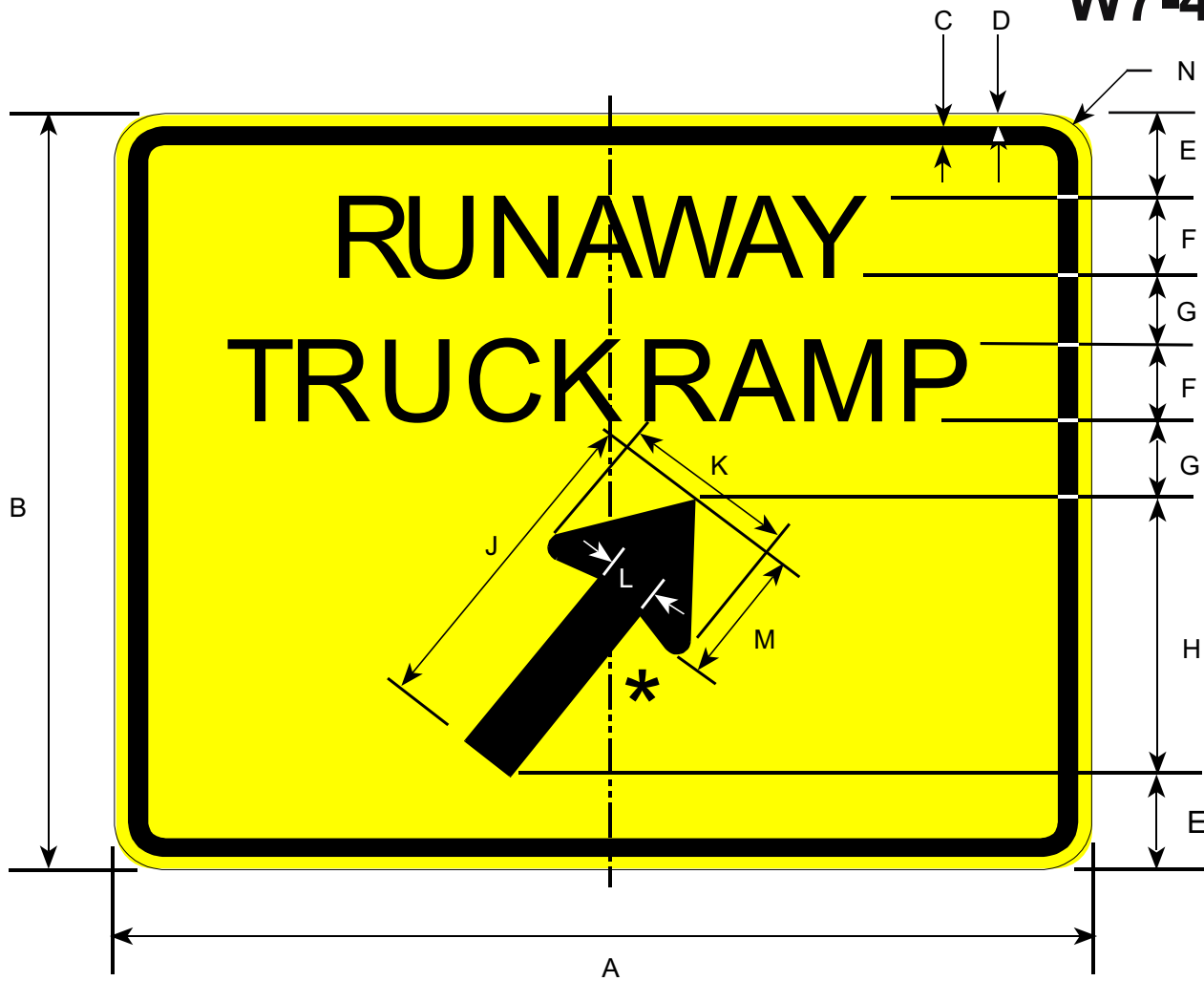

Border and Legend: Black
Background: Yellow

* See Appendix B-1 for Standard Arrow Details.

Prior to 2002 publication of this manual, this sign was numbered W7-4A.

Road Class	Dimensions (inches)												
	A	B	C	D	E	F	G	H	J	K	L	M	N
Expwy/Fwy	78	60	1.25	0.75	7.0	8C	5.0	20	27	15.13	3.75	11.56	3.0



Border and Legend: Black
Background: Yellow

W7-4D
W7-4E
W7-4F

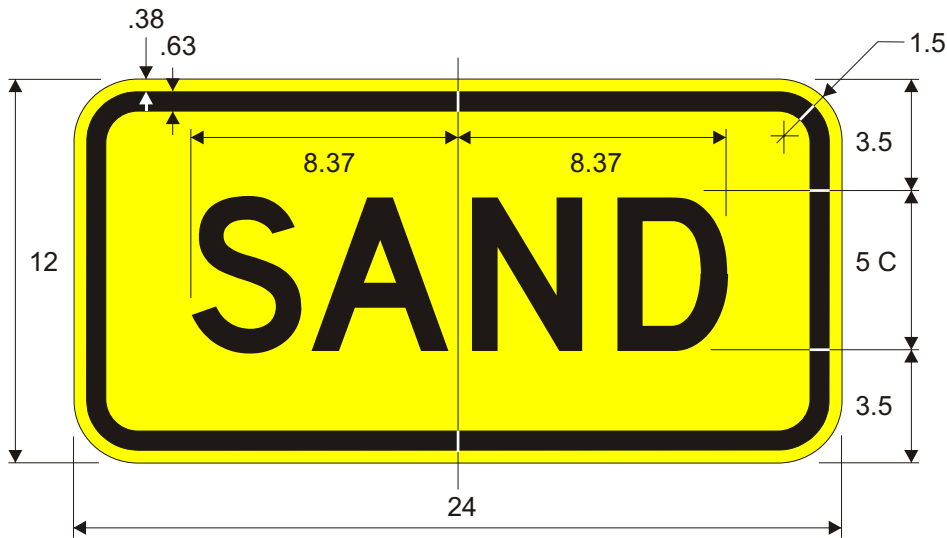

W7-4D

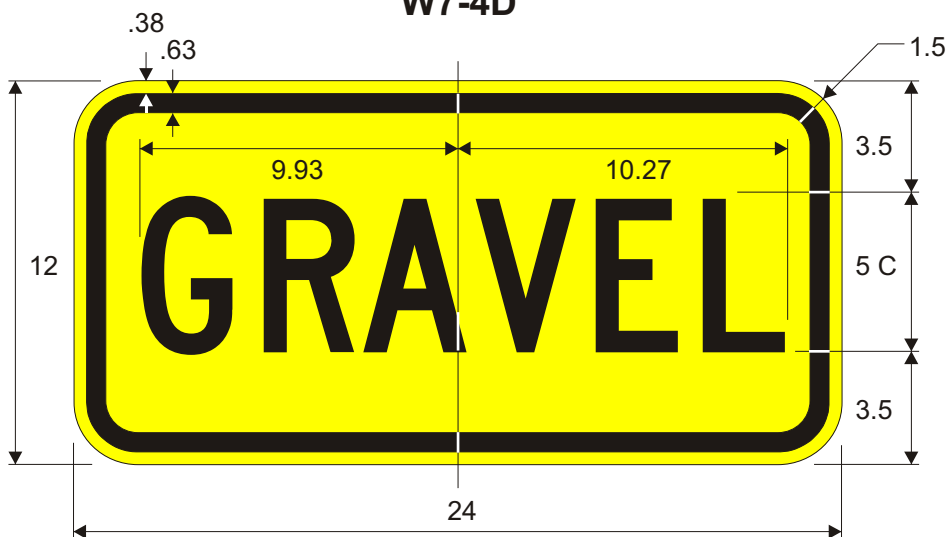

W7-4E

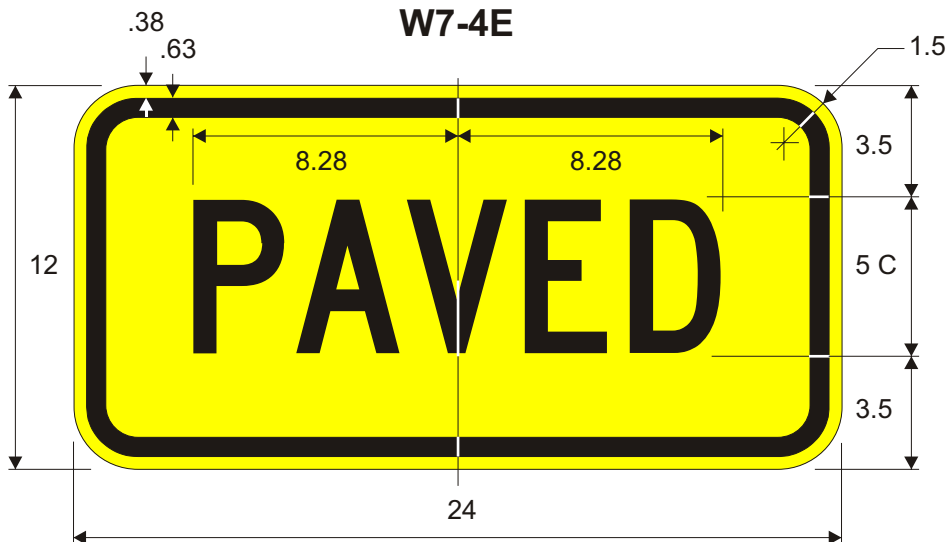

W7-4F

Border and Legend: Black
Background: Yellow

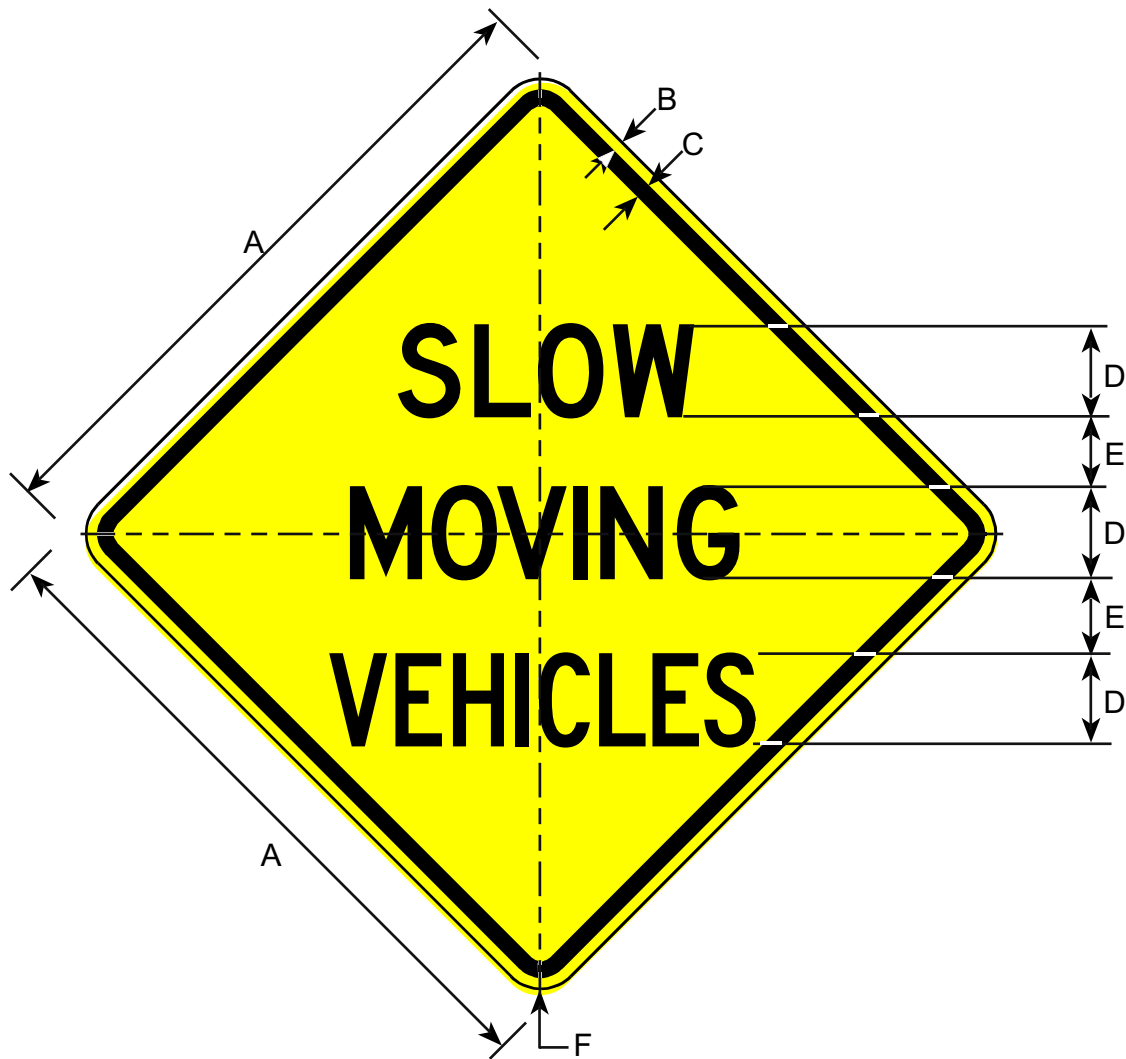

Border and Legend: Black
Background: Yellow

Prior to 2002 publication of this manual, this sign was numbered W7-6.

Road Class	Dimensions (inches)					
	A	B	C	D	E	F
Minimum	30	0.50	0.75	4C	3.0	1.88
Conventional	36	0.63	0.88	5C	3.5	2.25
Expwy/Fwy	48	0.75	1.25	7C	4.25	3.0

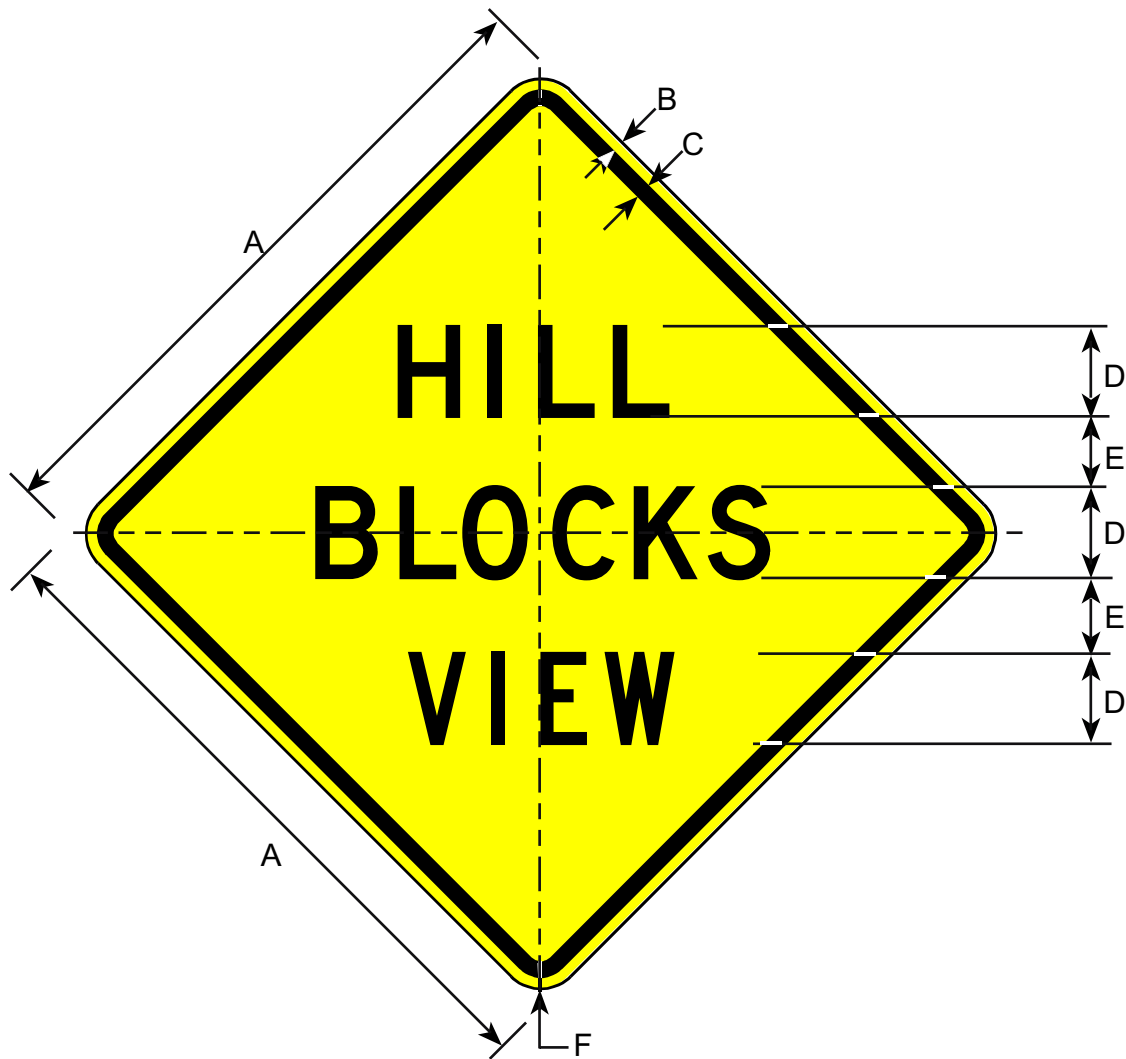

Border and Legend: Black
 Background: Yellow

Road Class	Dimensions (inches)					
	A	B	C	D	E	F
Minimum	30	0.50	0.75	4D	2.5	1.88
Conventional	36	0.63	0.88	5D	3.0	2.25
Expwy/Fwy	48	0.75	1.25	7D	4.25	3.0

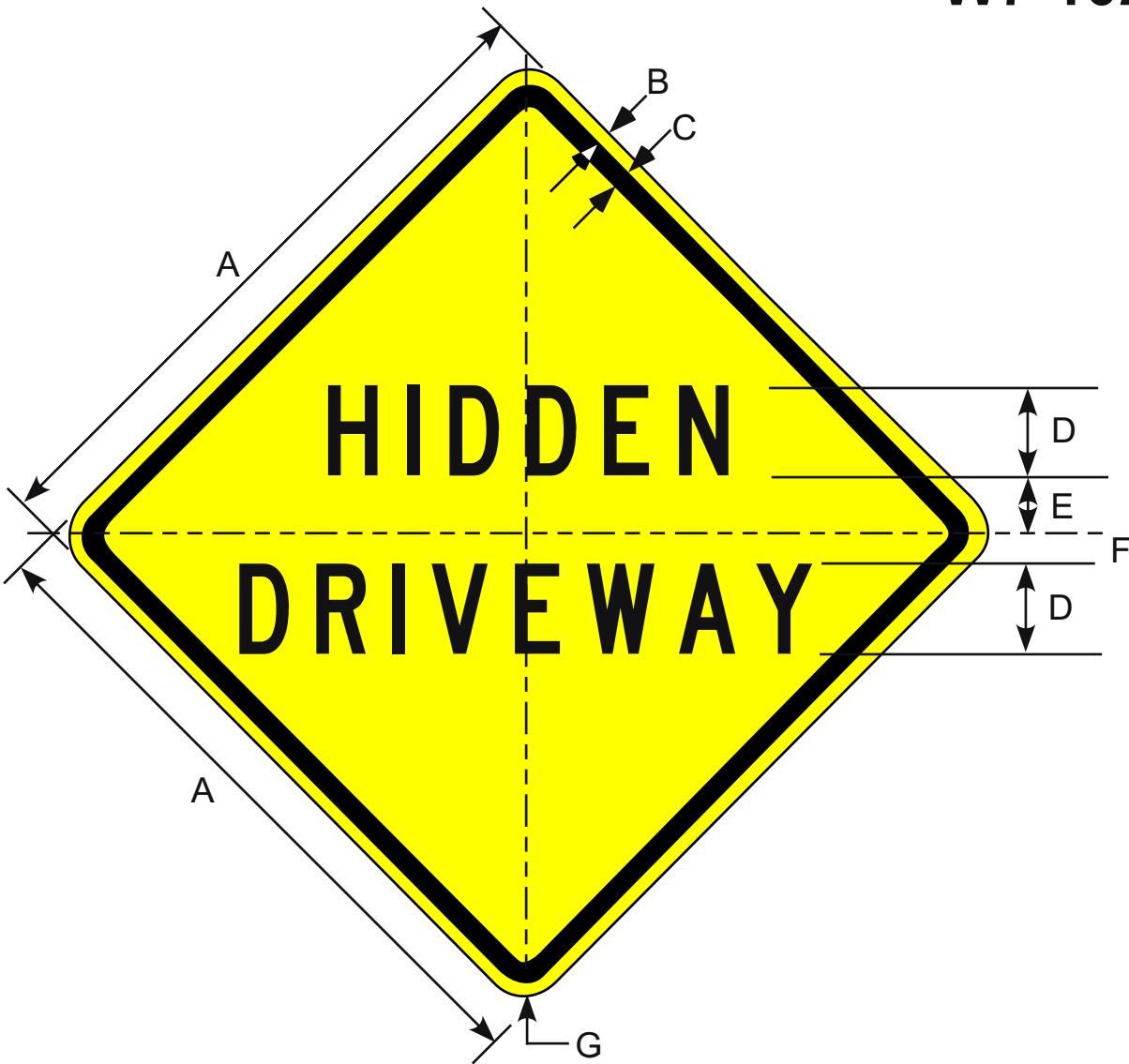

Border and Legend: Black
Background: Yellow

Road Class	Dimensions (inches)						
	A	B	C	D	E	F	G
Minimum	30	0.50	0.75	4C	2.50	1.25	1.88
Conventional	36	0.63	0.88	5C	3.25	1.63	2.25
Expwy/Fwy	48	0.75	1.25	7C	4.75	2.38	3.00

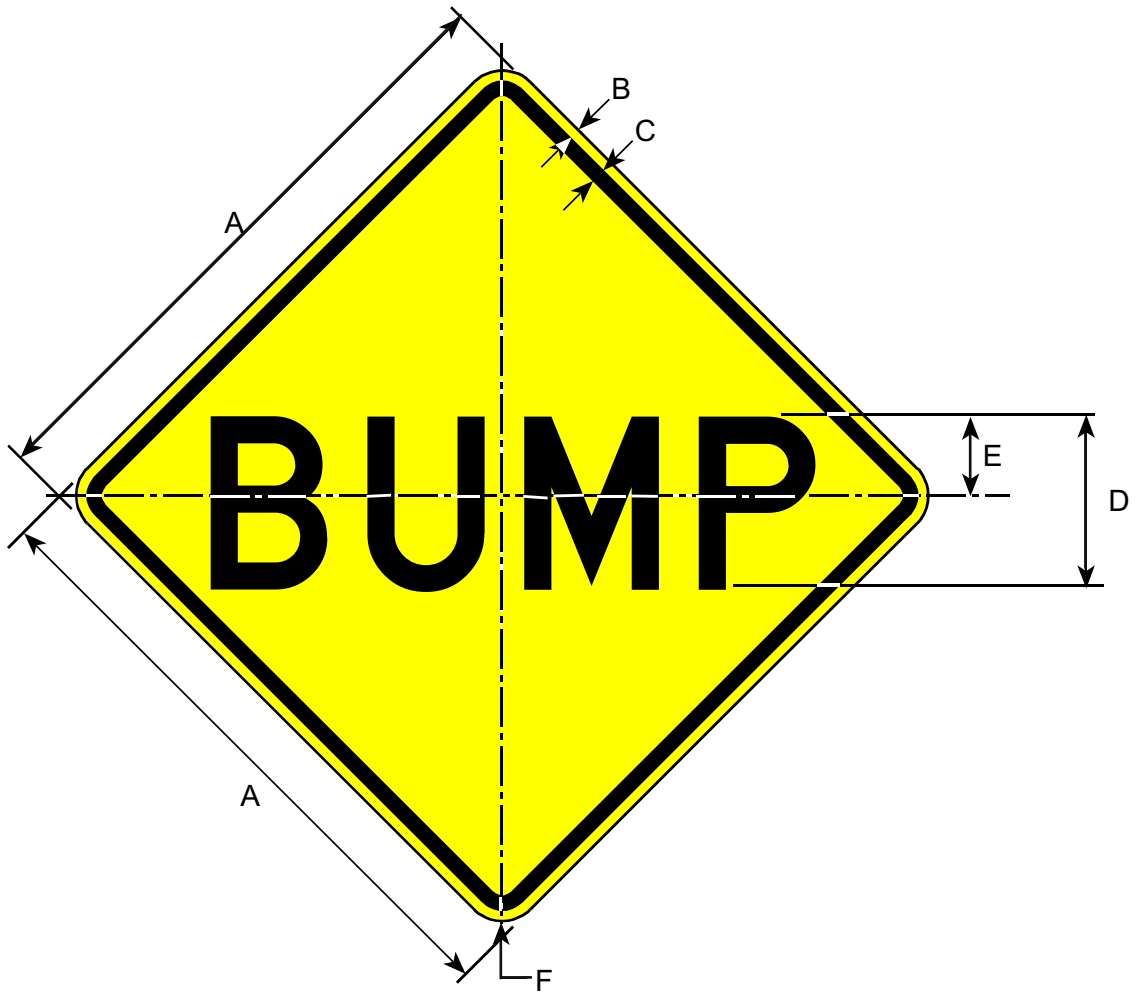

Border and Legend: Black
Background: Yellow

Road Class	Dimensions (inches)					
	A	B	C	D	E	F
Bike	24	0.38	0.63	6D	3	1.50
Minimum	30	0.50	0.75	8D	4	1.88
Conventional	36	0.63	0.88	10D	5	2.25
Expwy/Fwy	48	0.75	1.25	12D	6	3.00

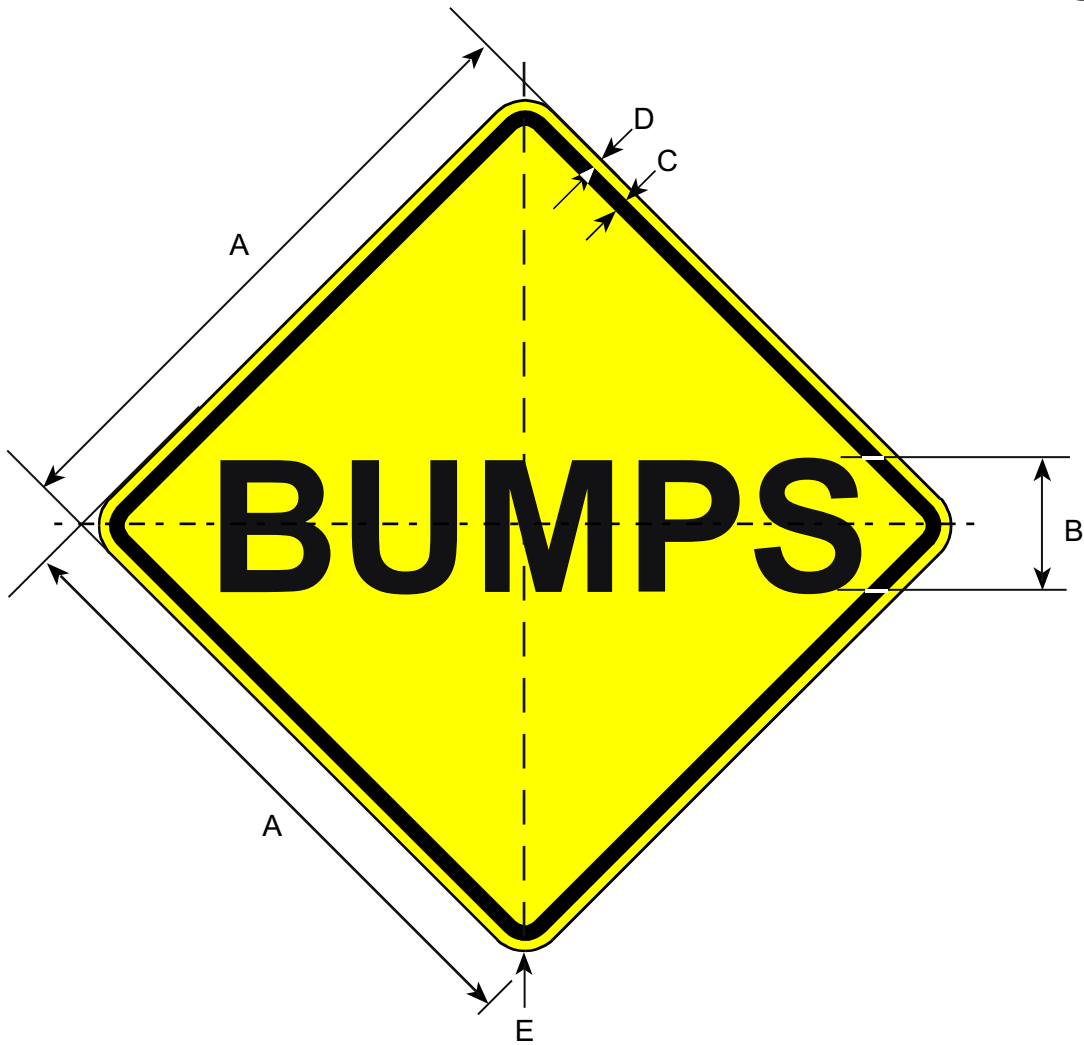

Border and Legend: Black
Background: Yellow

Road Class	Dimensions (inches)				
	A	B	C	D	E
Minimum	30	6D	0.75	0.50	1.88
Conventional	36	8D	0.88	0.63	2.25
Expwy/Fwy	48	10D	1.25	0.75	3.0

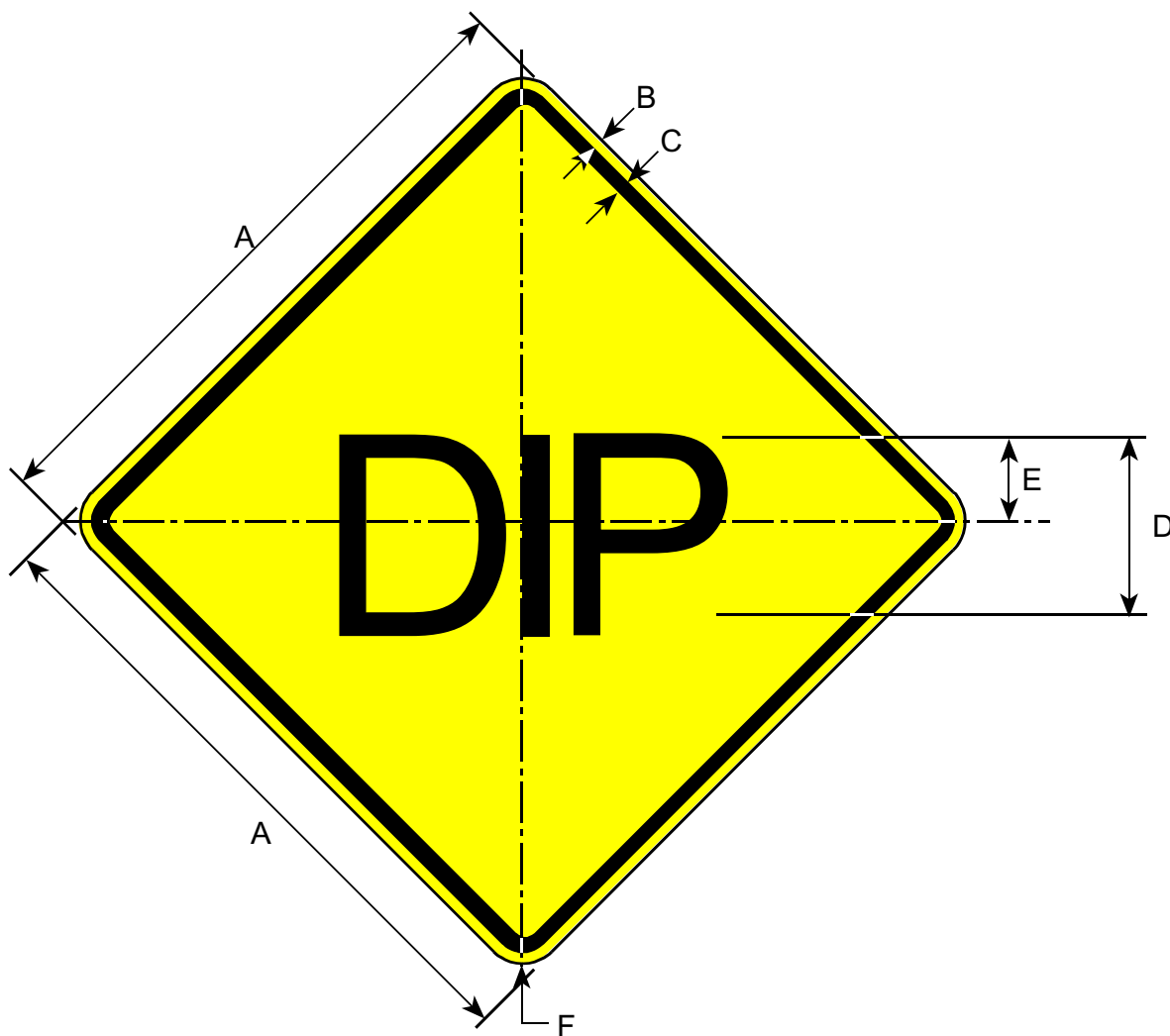

Border and Legend: Black
Background: Yellow

Road Class	Dimensions (inches)					
	A	B	C	D	E	F
Minimum	30	0.50	0.75	8E	4	1.88
Conventional	36	0.63	0.88	10E	5	2.25
Expwy/Fwy	48	0.75	1.25	12E	6	3.00

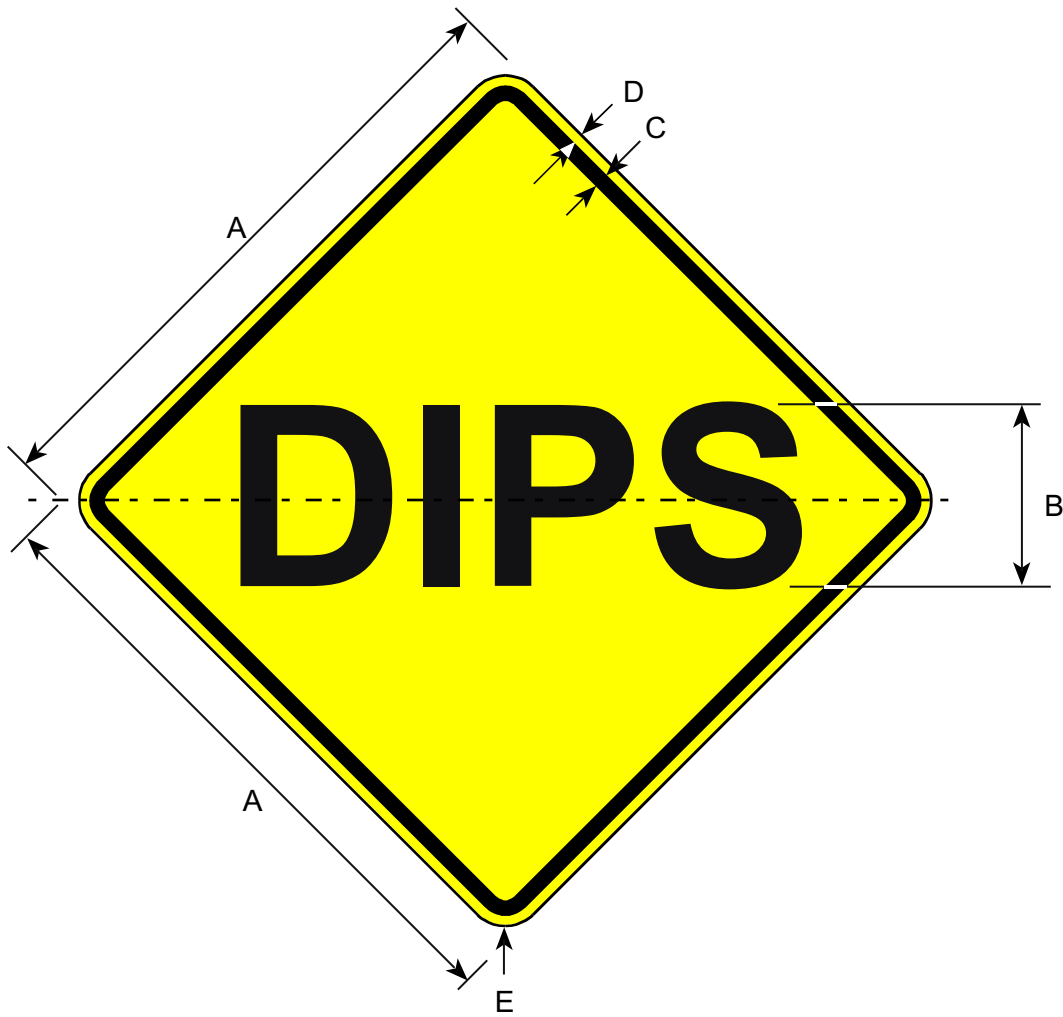

Border and Legend: Black
Background: Yellow

Road Class	Dimensions (inches)				
	A	B	C	D	E
Minimum	30	7E	0.75	0.50	1.88
Conventional	36	8E	0.88	0.63	2.25
Expwy/Fwy	48	10E	1.25	0.75	3.0

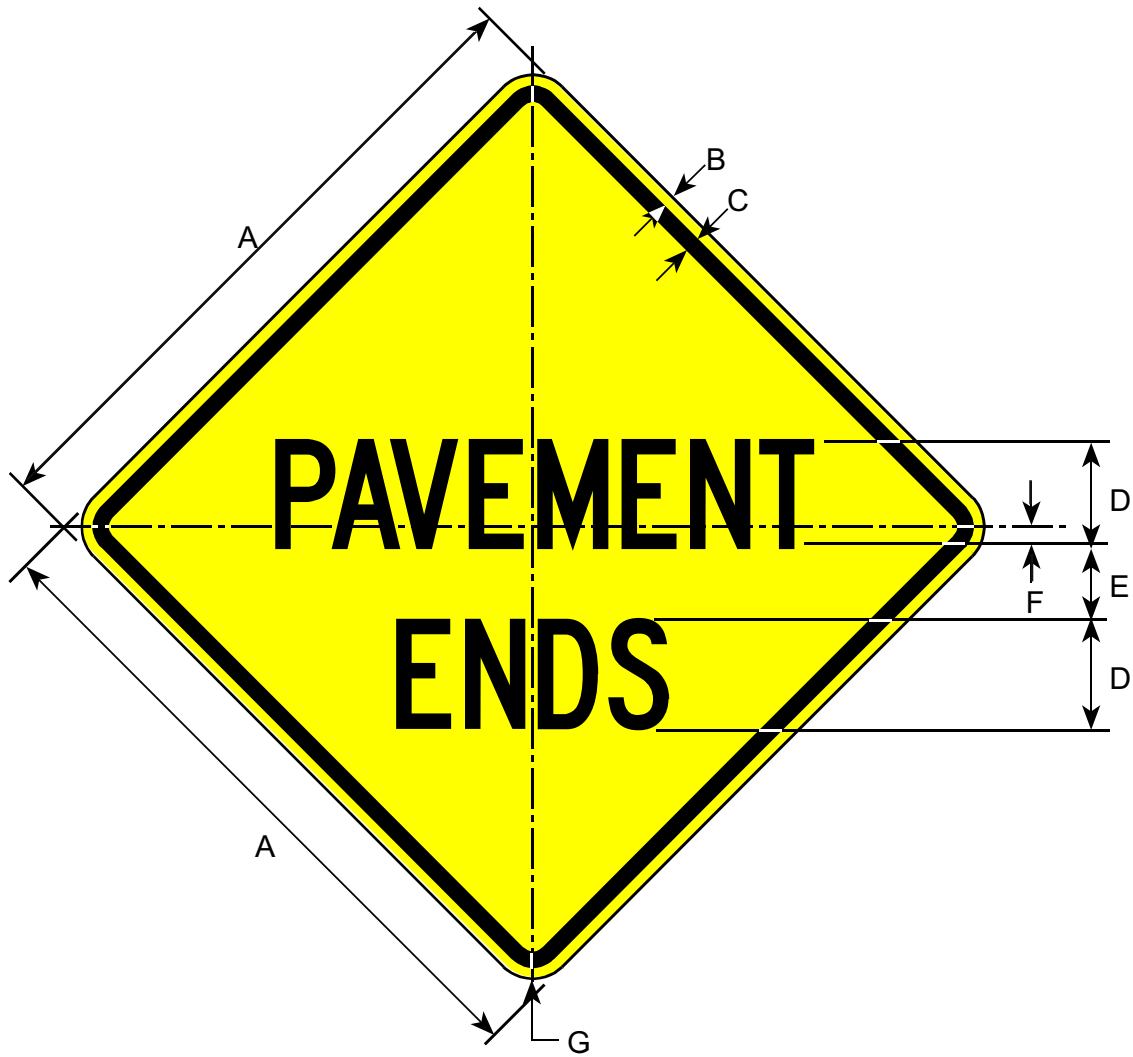

Border and Legend: Black
Background: Yellow

Road Class	Dimensions (inches)						
	A	B	C	D	E	F	G
Bike	18	0.38	0.63	4C	2.5	0.50	1.5
Conventional	36	0.63	0.88	6C	3.5	1.0	2.25
Expwy/Fwy	48	0.75	1.25	8C	4.5	1.5	3.0

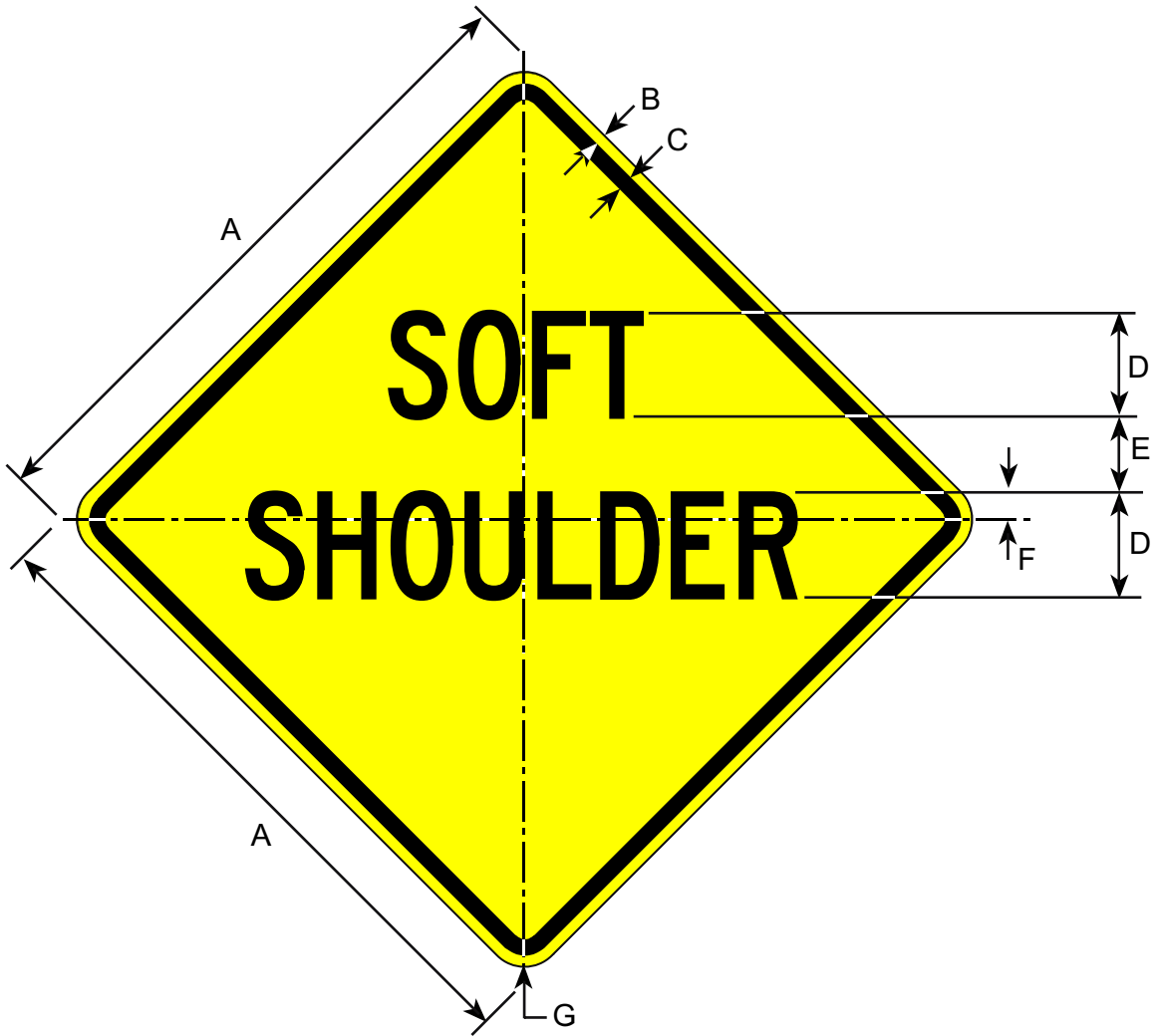

Border and Legend: Black
Background: Yellow

Road Class	Dimensions (inches)						
	A	B	C	D	E	F	G
Minimum	30	0.50	0.75	5C	3.0	0.75	1.88
Conventional	36	0.63	0.88	6C	3.5	1.00	2.25
Expwy/Fwy	48	0.75	1.25	8C	5.0	1.25	3.00

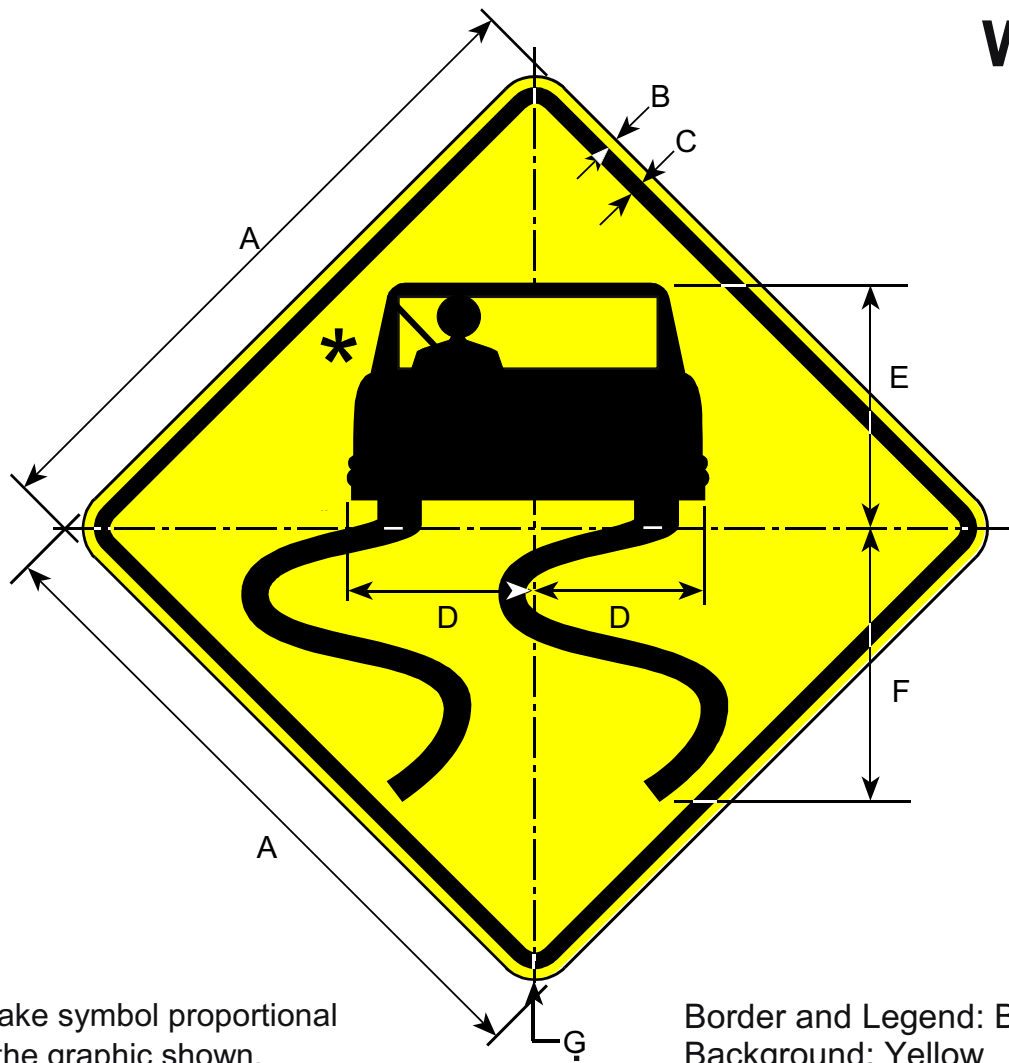

Sign shall only be used with
W8-5P-Slippery When Wet (Plate)

Road Class	Dimensions (inches)						
	A	B	C	D	E	F	G
Minimum	30	0.50	0.75	8.0	11	12.5	1.88
Conventional	36	0.63	0.88	9.5	13	14.81	2.25
Expwy/Fwy	48	0.75	1.25	12.63	17.33	19.75	3.0



Border and Legend: Black
Background: Yellow

Plate shall only be used with
W8-5 - Slippery When Wet

Road Class	Dimensions (inches)												
	A	B	C	D	E	F	G	H	J	K	L	M	N
Conventional	24	18	0.38	0.63	4.0	4C	3C	3.0	8.69	8.63	9.88	10	1.5

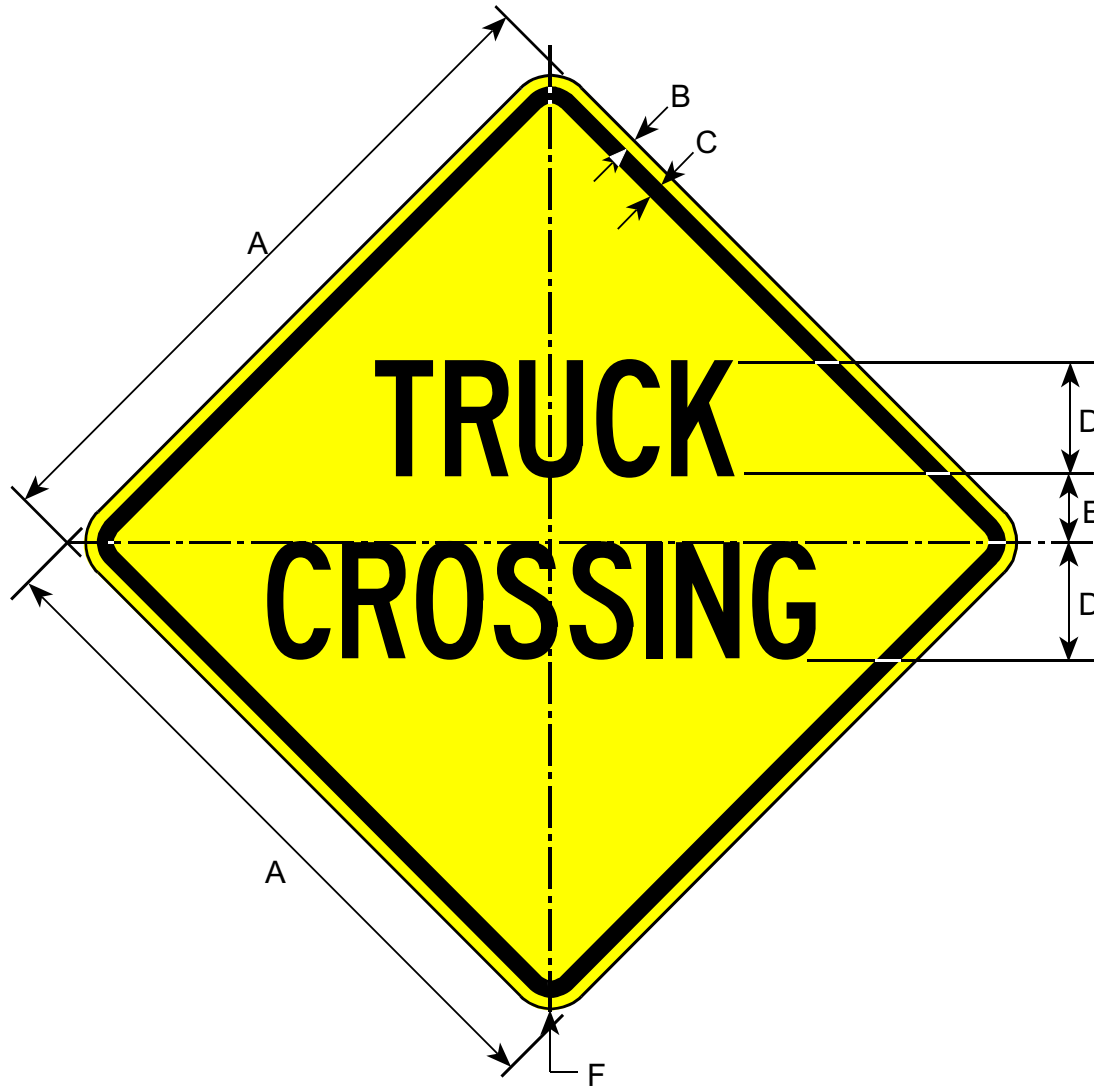

Border and Legend: Black
Background: Yellow

Road Class	Dimensions (inches)					
	A	B	C	D	E	F
Minimum	30	0.50	0.75	5C	3.0	1.88
Conventional	36	0.63	0.88	6C	3.5	2.25
Expwy/Fwy	48	0.75	1.25	8C	5.0	3.00

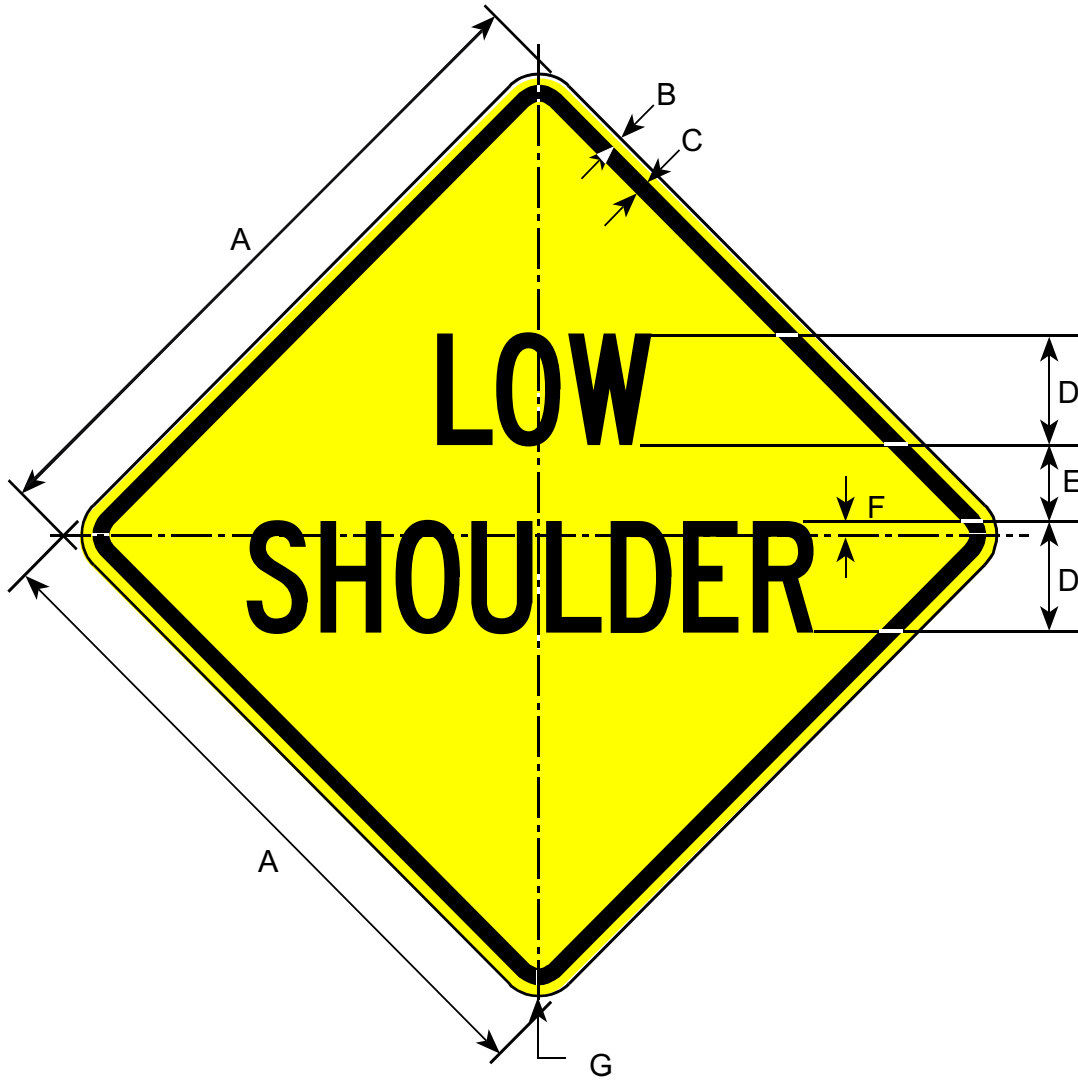

Border and Legend: Black
Background: Yellow

Road Class	Dimensions (inches)						
	A	B	C	D	E	F	G
Minimum	30	0.50	0.75	5C	3.0	0.75	1.88
Conventional	36	0.63	0.88	6C	3.5	1.00	1.25
Expwy/Fwy	48	0.75	1.25	8C	5.0	1.25	3.00

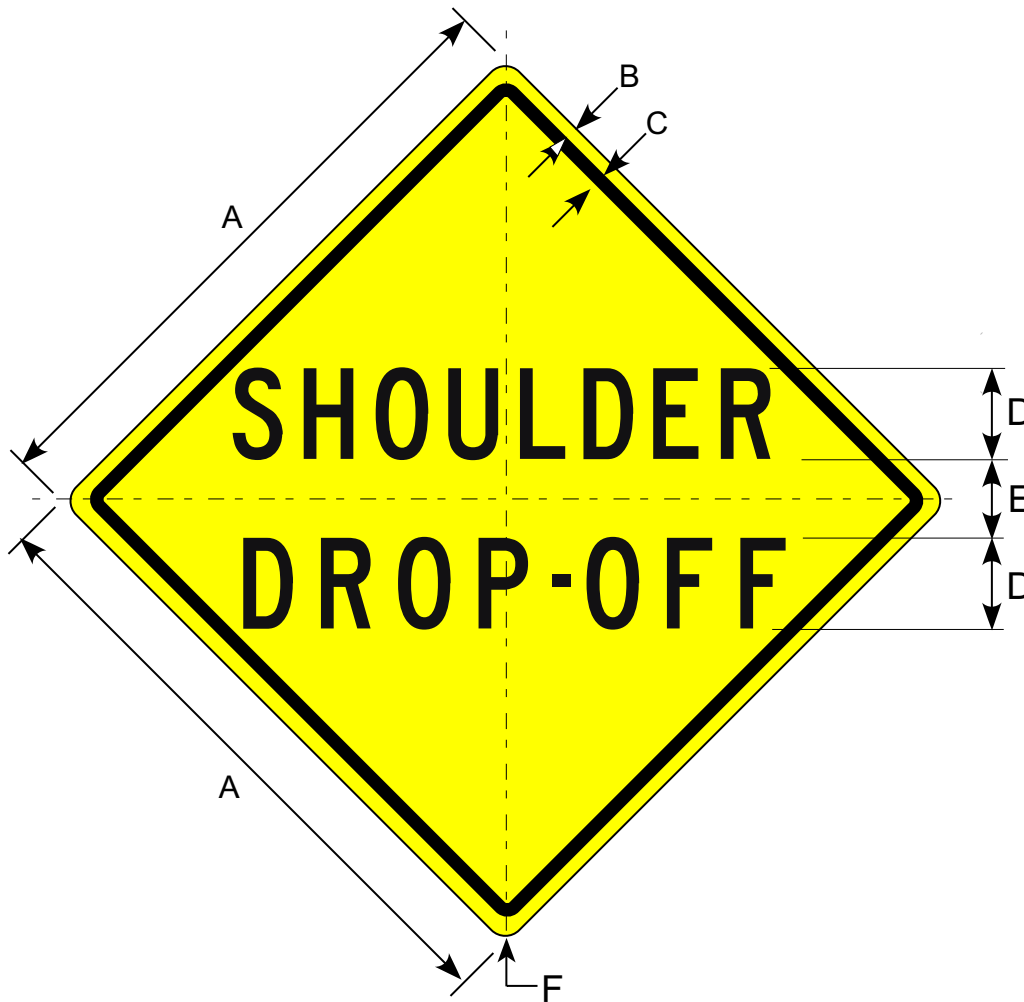

Border and Legend: Black
Background: Yellow

Road Class	Dimensions (inches)					
	A	B	C	D	E	F
Minimum	30	0.50	0.75	5C	3.75	1.9
Conventional	36	0.63	0.88	6C	4.50	2.3
Expwy/Fwy	48	0.75	1.25	7C	6.00	3.0

W8-10 W8-10A

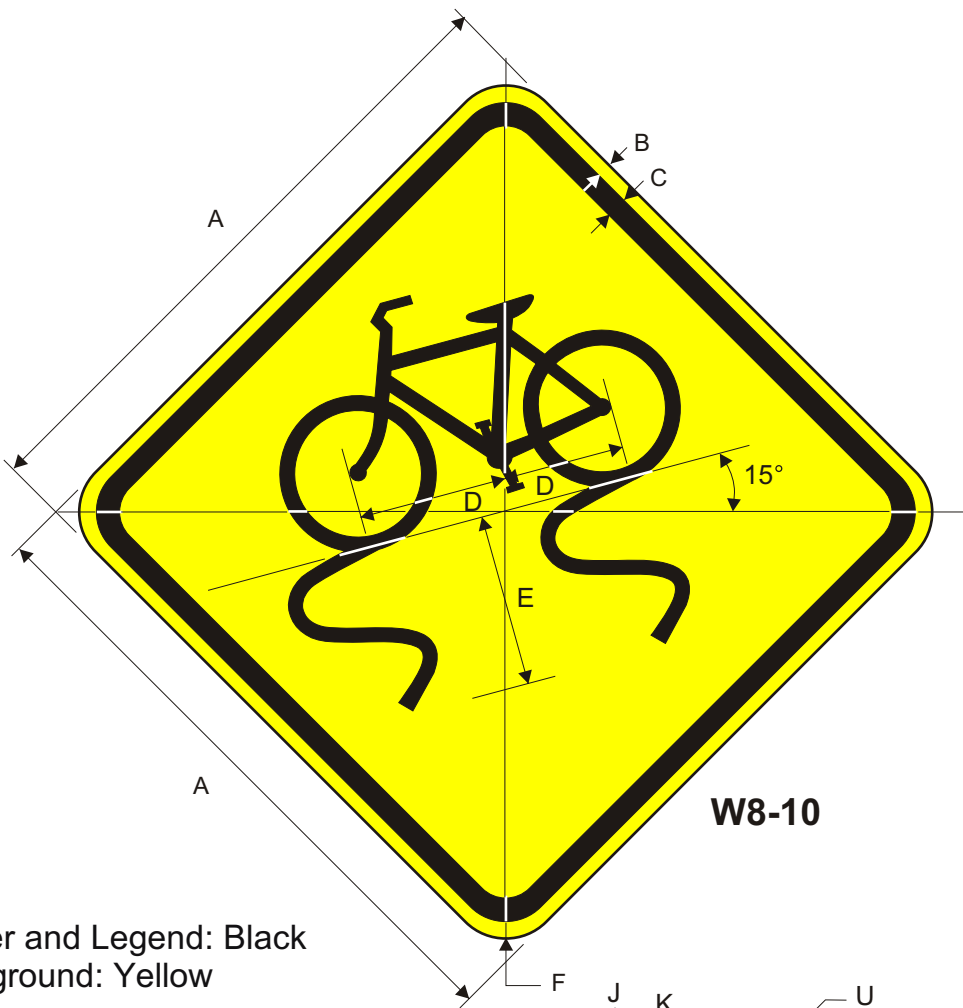

W8-10

Border and Legend: Black
Background: Yellow



W8-10a

*Reduce spacing 25%

Road Class	Dimensions (inches)											
	A	B	C	D	E	F	G	H	J	K	L	M
Shared Use Path	18	0.38	0.63	3.63	4.66	1.5	12	9.0	0.38	0.38	2.0	2C
Roadway	24	0.38	0.63	4.83	6.21	1.5	24	18	0.38	0.63	4.0	4C

N	P	Q	R	S	T	U
1.5	1.5C	5.0	5.25	4.63	4.25	1.5
3.0	3C	10	10.38	9.0	8.63	1.5

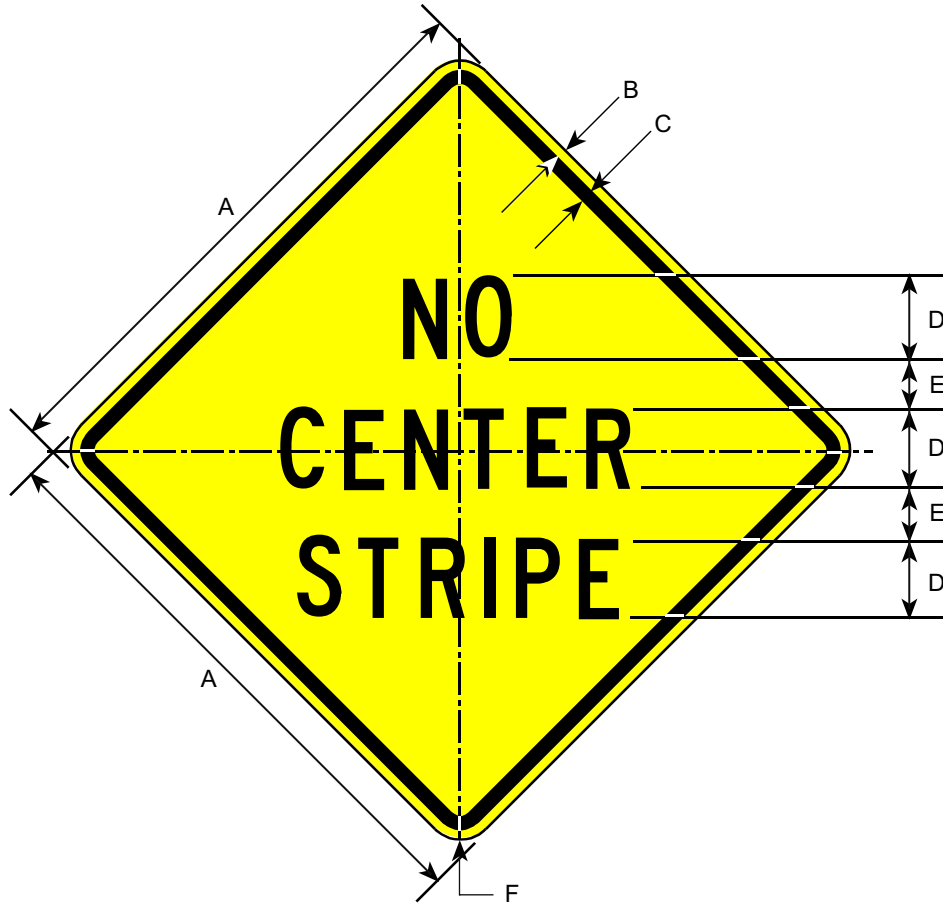

Border and Legend: Black
Background: Yellow

Road Class	Dimensions (inches)					
	A	B	C	D	E	F
Minimum	30	0.50	0.75	4C	2.50	1.88
Conventional	36	0.63	0.88	5C	3.25	2.25
Expwy/Fwy	48	0.75	1.25	7C	4.50	3.00

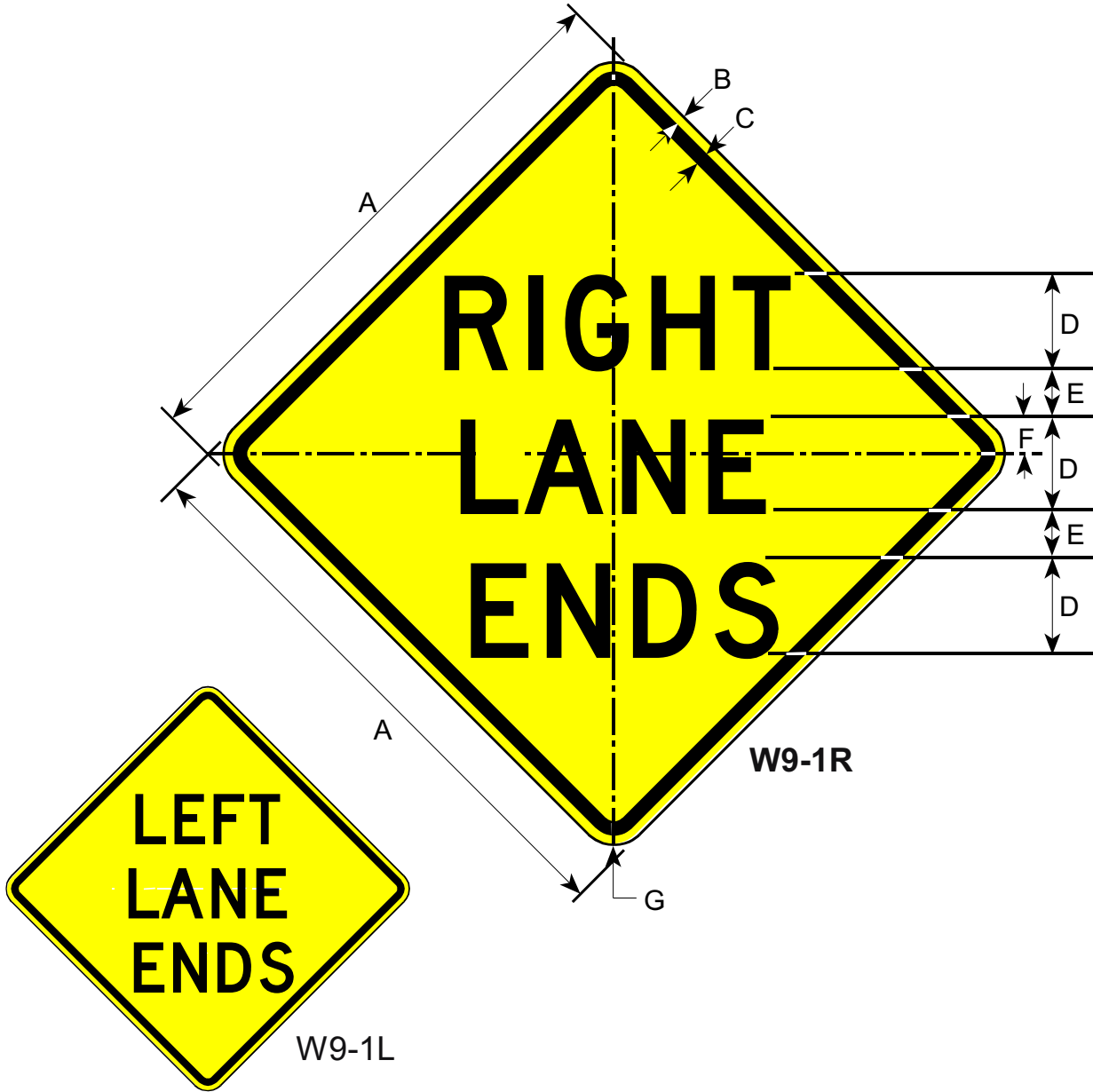

Border and Legend: Black
Background: Yellow

Road Class	Dimensions (inches)						
	A	B	C	D	E	F	G
Minimum	30	0.50	0.75	5D	2.5	1.5	1.88
Conventional	36	0.63	0.88	6D	3.0	2.0	2.25
Expwy/Fwy	48	0.75	1.25	8D	4.0	3.0	3.0

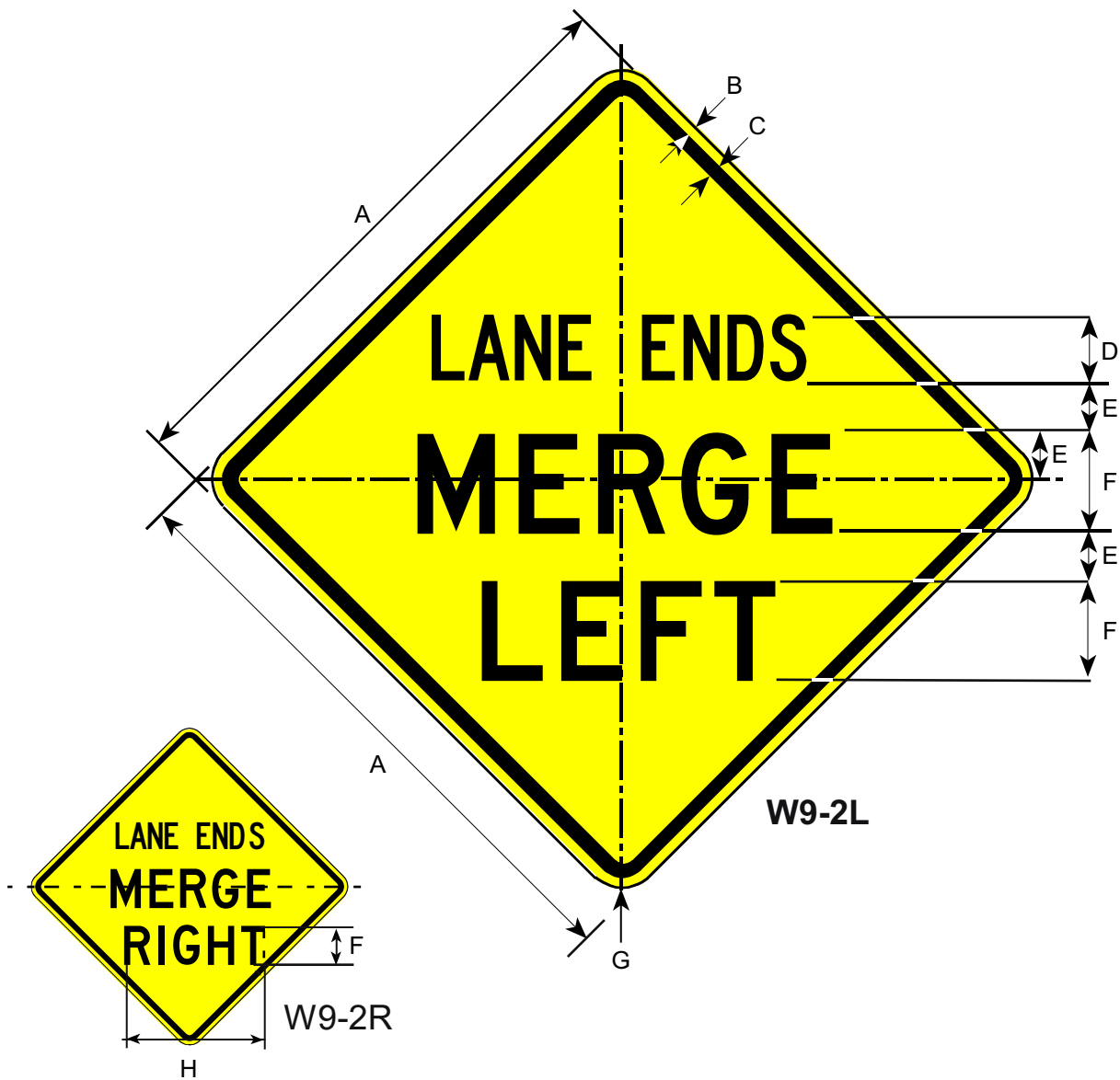

Border and Legend: Black
Background: Yellow

Road Class	Dimensions (inches)							
	A	B	C	D	E	F	G	H
Minimum	30	0.50	0.75	3C	2.5	5D	1.88	18.38
Conventional	36	0.63	0.88	4C	3.0	6D	2.25	22
Expwy/Fwy	48	0.75	1.25	6C	4.0	8D	3.0	29.5

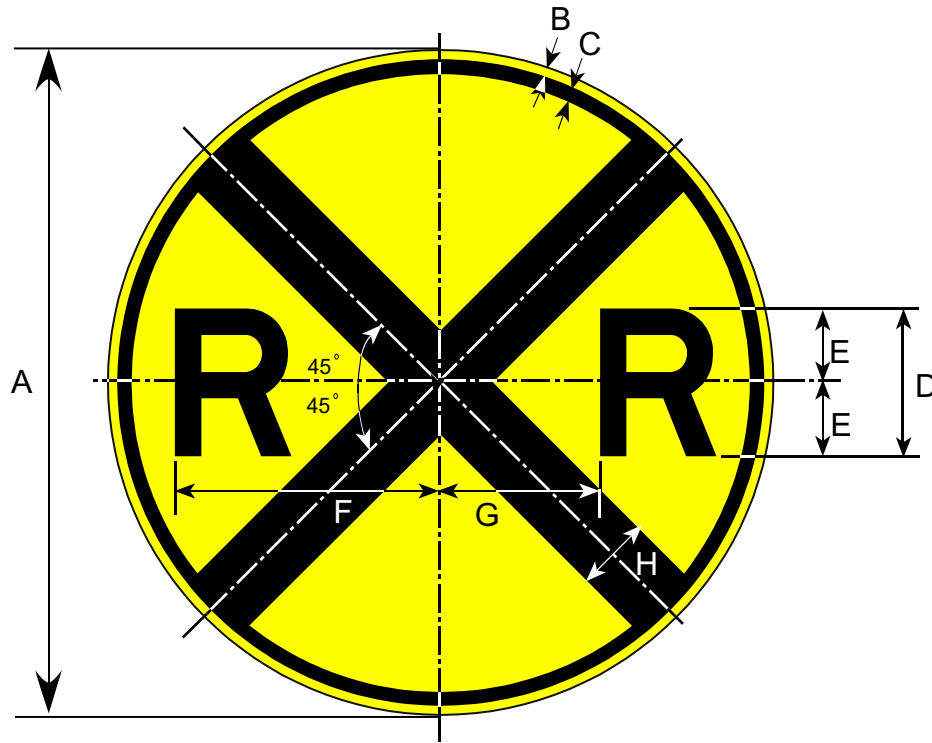

Border and Legend: Black
Background: Yellow

Make symbol proportional
to the one shown.

Road Class	Dimensions (inches)							
	A	B	C	D	E	F	G	H
Minimum	30	0.38	0.63	7E	3.5	12.38	7.13	3.0
Conventional	36	0.50	0.75	8E	4.0	14.38	8.63	4.0
Expwy/Fwy	48	0.75	1.25	10E	5.0	18.38	11.63	5.0

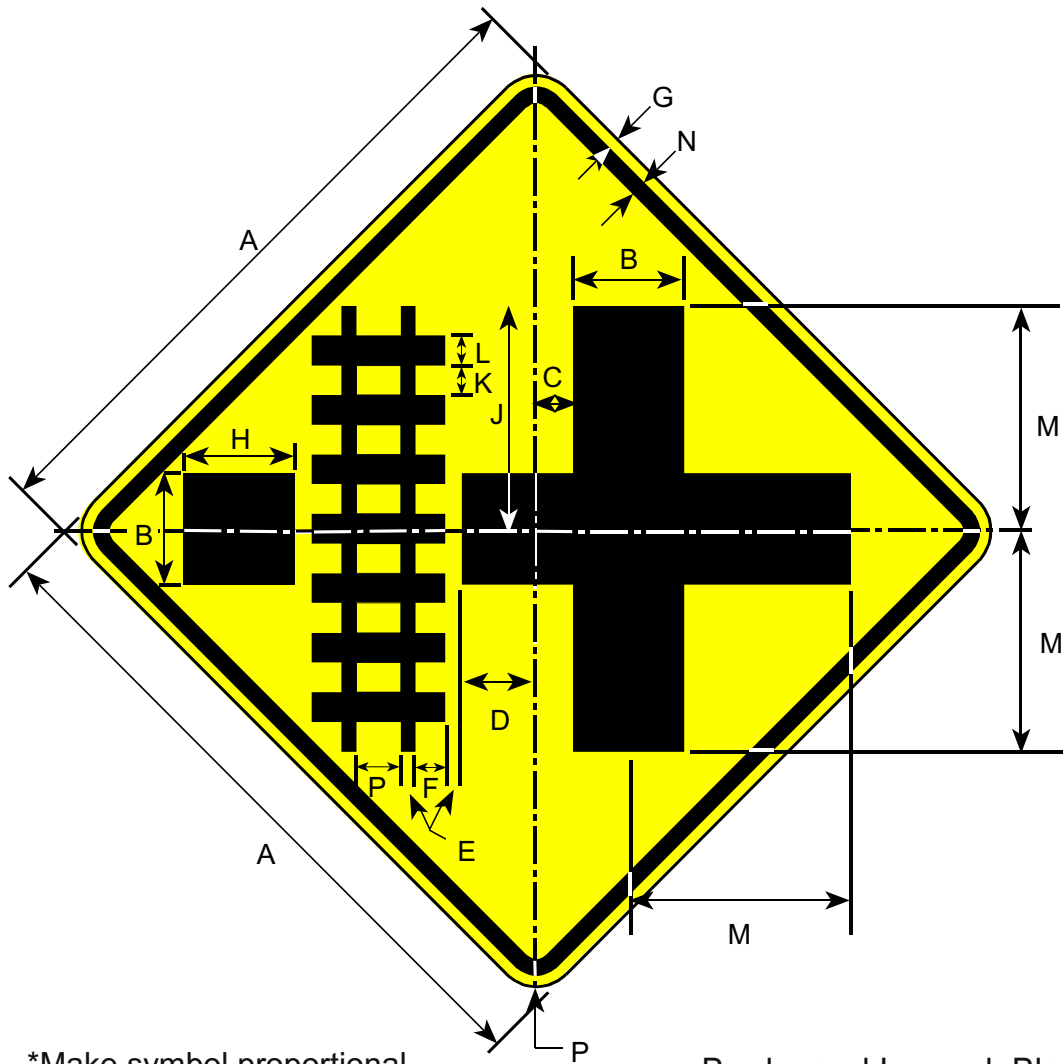

*Make symbol proportional to the graphic shown.

Border and Legend: Black
Background: Yellow

Prior to the 2002 publication of this manual, this sign was numbered W10-4.

Road Class	Dimensions (inches)													
	A	B	C	D	E	F	G	H	J	K	L	M	N	P
Minimum	30	4.13	3.5	4.75	0.63	0.88	0.50	2.88	8.38	1.13	1.25	10.38	0.75	1.88
Conventional	36	5.0	4.25	5.75	0.75	1.13	0.63	3.5	10.06	1.38	1.5	12.5	0.88	2.25
Expwy/Fwy	48	6.63	5.63	7.88	1.0	1.5	0.75	4.63	13.13	1.75	2.0	16.56	1.25	3.0

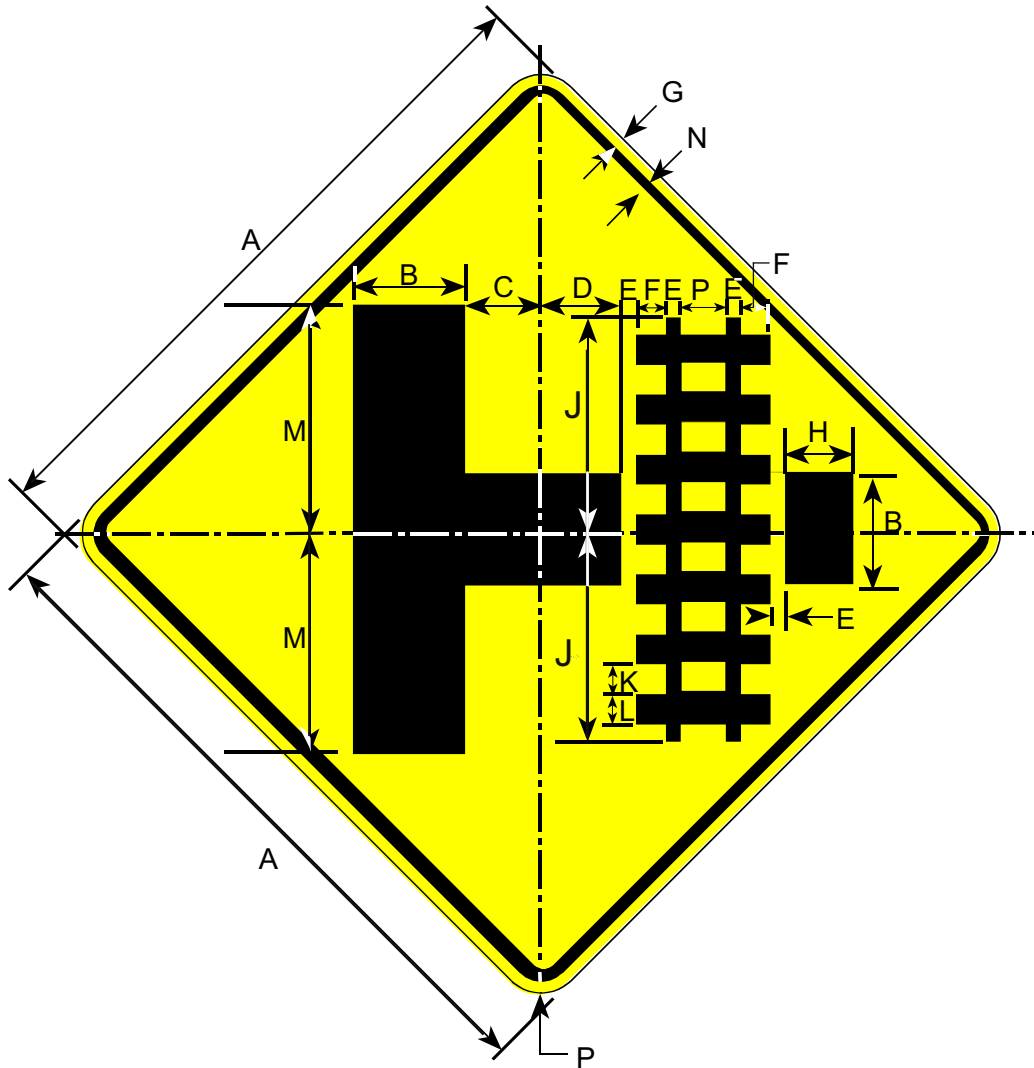

*Make symbol proportional to the graphic shown.

Border and Legend: Black
Background: Yellow

Road Class	Dimensions (inches)													
	A	B	C	D	E	F	G	H	J	K	L	M	N	P
Minimum	30	4.13	3.50	4.75	0.63	0.88	0.50	2.88	8.38	1.13	1.25	10.38	0.75	1.88
Conventional	36	5.00	4.25	5.75	0.75	1.13	0.63	3.50	10.06	1.38	1.50	12.50	0.88	2.25
Expwy/Fwy	48	6.63	5.63	7.88	1.00	1.50	0.75	4.63	13.13	1.75	2.00	16.56	1.25	3.00

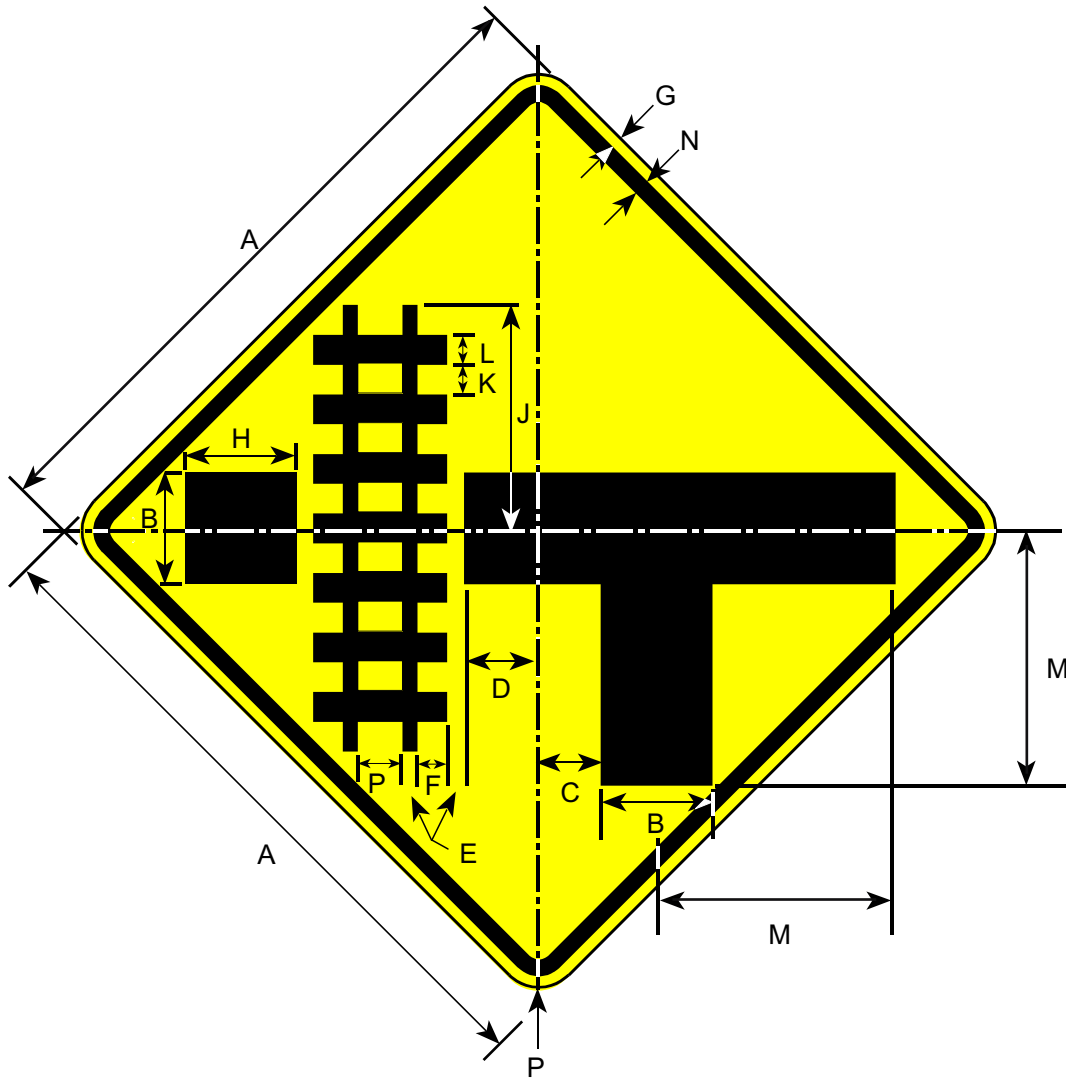

*Make symbol proportional to the graphic shown.

Border and Legend: Black
Background: Yellow

Road Class	Dimensions (inches)													
	A	B	C	D	E	F	G	H	J	K	L	M	N	P
Minimum	30	4.25	3.5	4.75	0.63	0.88	0.50	2.88	8.38	1.13	1.25	10.38	0.75	1.88
Conventional	36	5.0	4.25	5.75	0.75	1.13	0.63	3.5	10.06	1.38	1.5	12.5	0.88	2.25
Expwy/Fwy	48	6.63	5.63	7.88	1.0	1.5	0.75	4.63	13.13	1.75	2.0	16.56	1.25	3.0

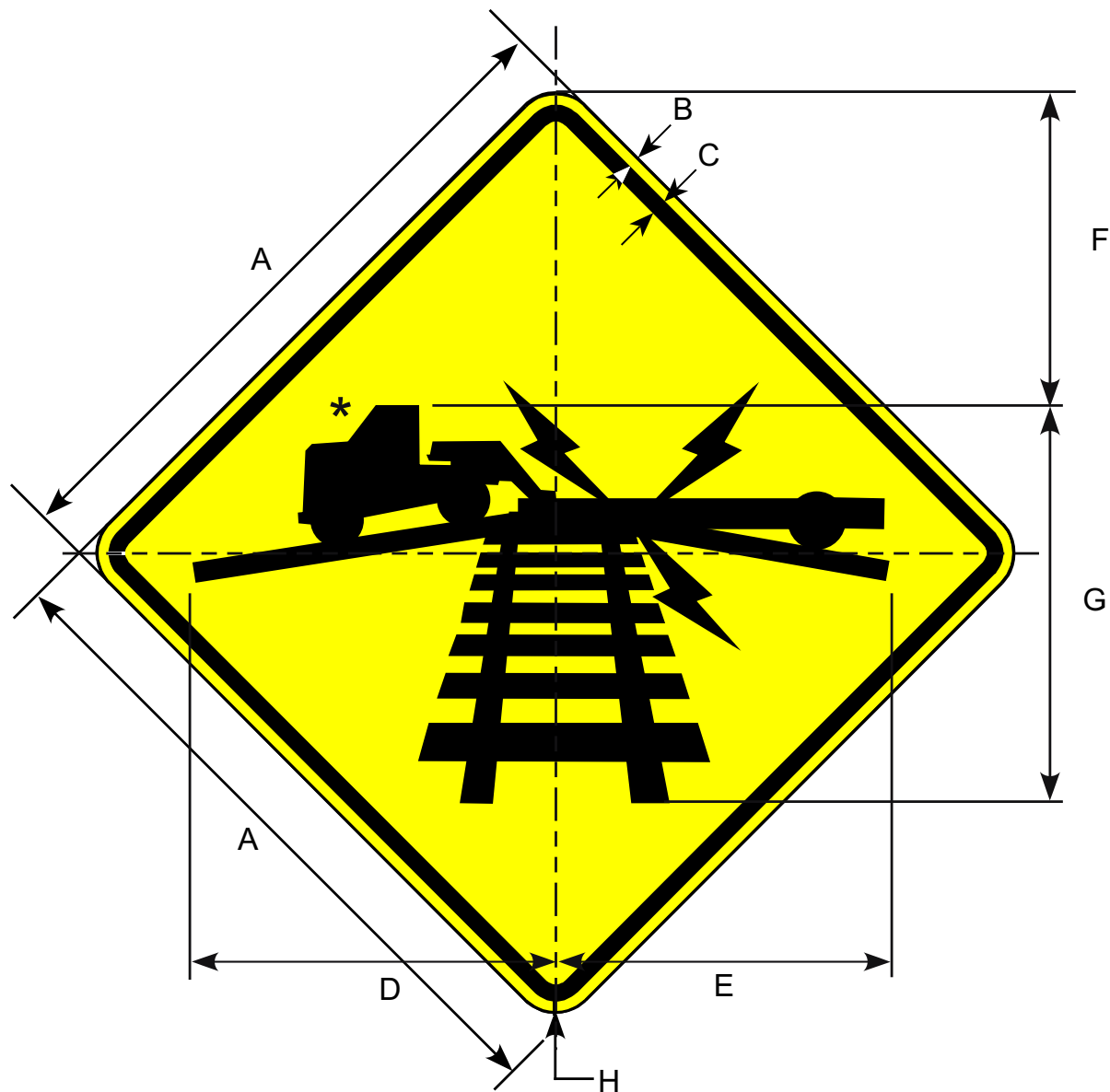

Border and Legend: Black
Background : Yellow

* Make symbol proportional
to the one shown.

Road Class	Dimensions (inches)							
	A	B	C	D	E	F	G	H
Minimum	30	0.50	0.75	15.69	15.25	13.41	17.53	1.88
Conventional	36	0.63	0.88	19.29	18.89	15.45	21.62	2.25
Expwy/Fwy	48	0.75	1.25	24.86	24.46	20.62	27.86	3.00

W10-9 W10-10



W10-9

Sign Shall Only Be Used With W10-1

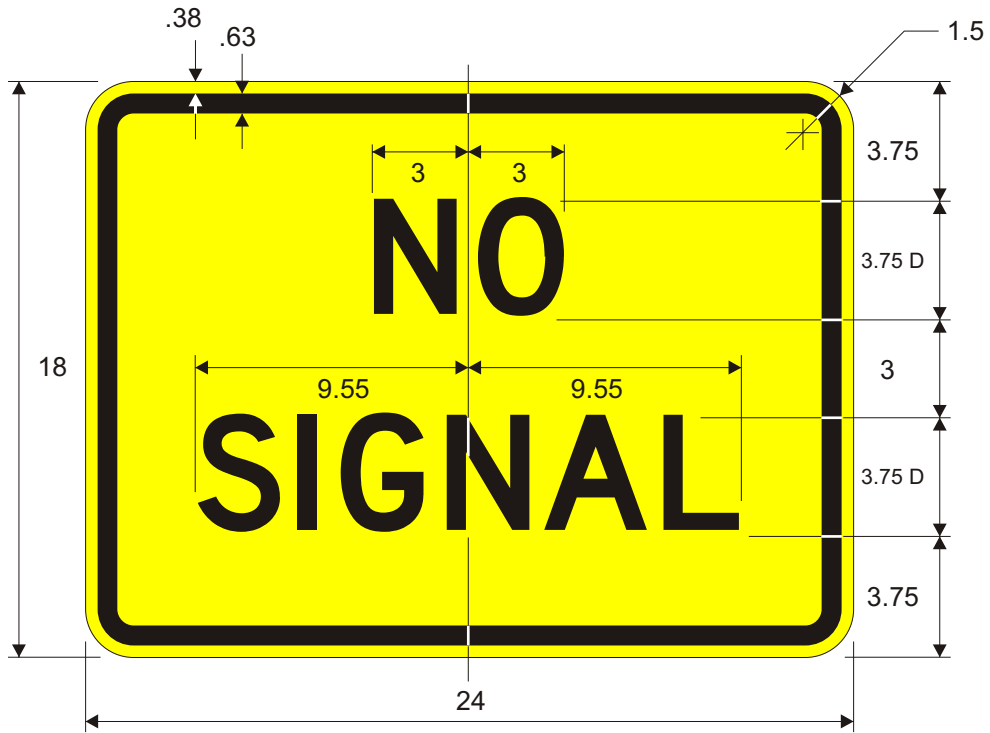

W10-10

Border and Legend: Black
Background: Yellow

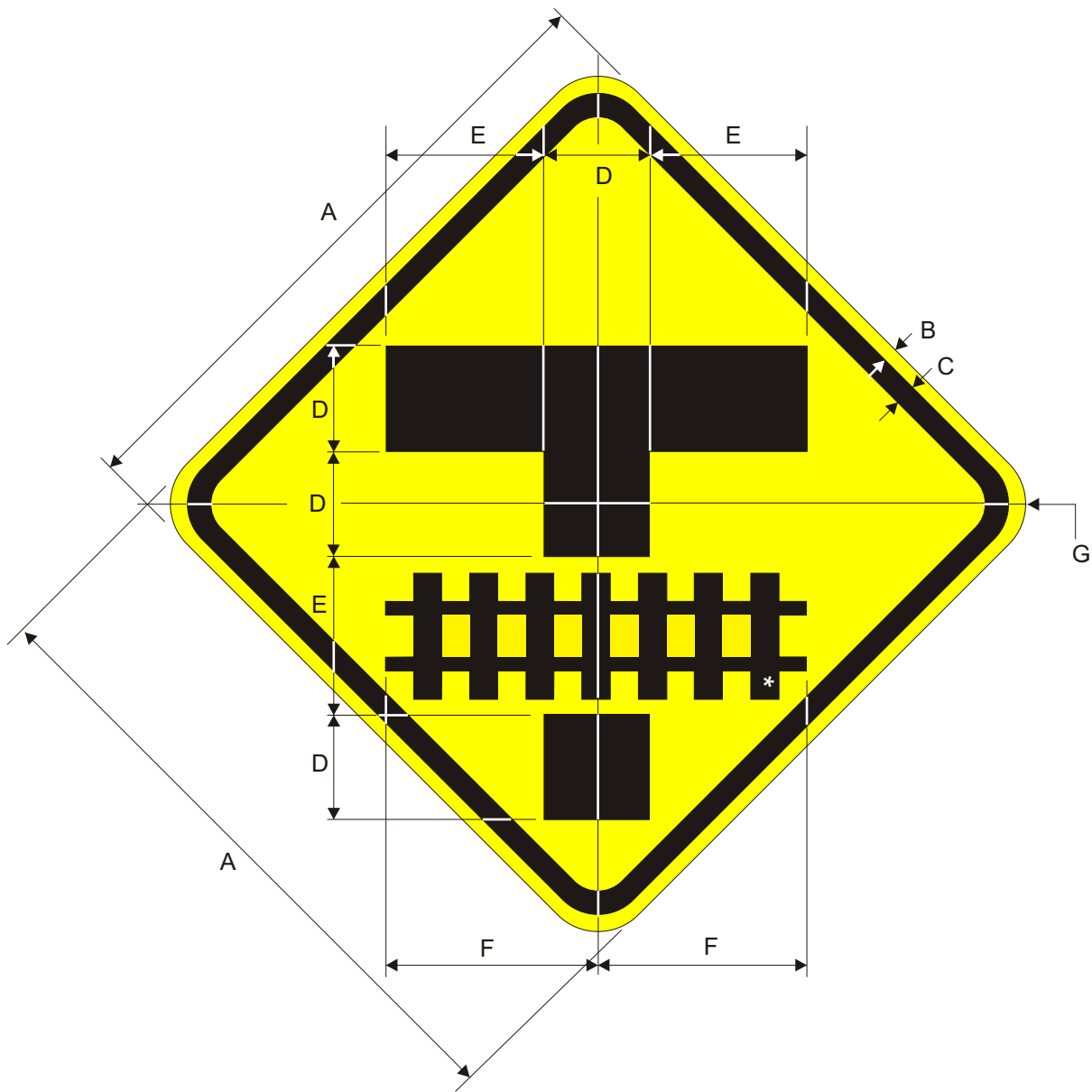

Border and Legend: Black
Background: Yellow

Road Class	Dimensions (inches)						
	A	B	C	D	E	F	G
Min.	30	0.5	0.75	5.0	7.49	10	1.88
Conv.	36	0.63	0.88	6.0	9.0	12	2.25
Expy	48	0.75	1.25	8.0	12	16	3.0

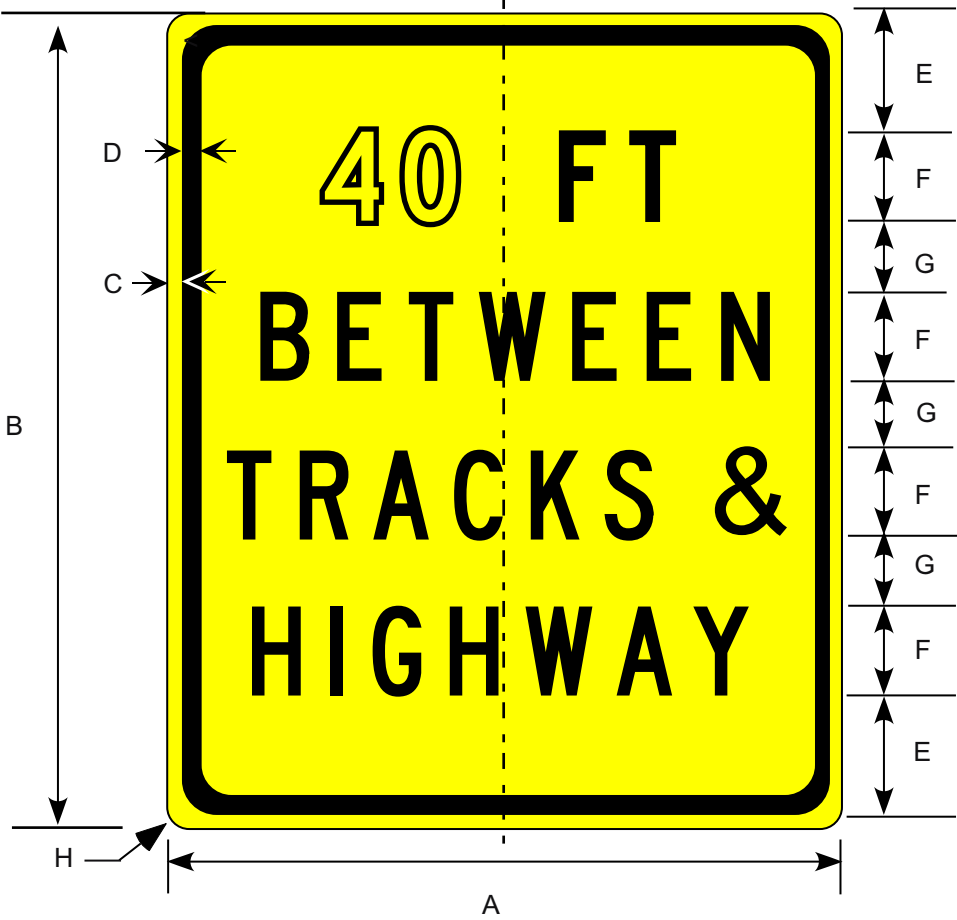

Border and Legend: Black
 Background: Yellow

Road Class	Dimensions (inches)							
	A	B	C	D	E	F	G	H
Conv & Min	30	36	0.50	0.75	5.13	4C	3.25	1.88

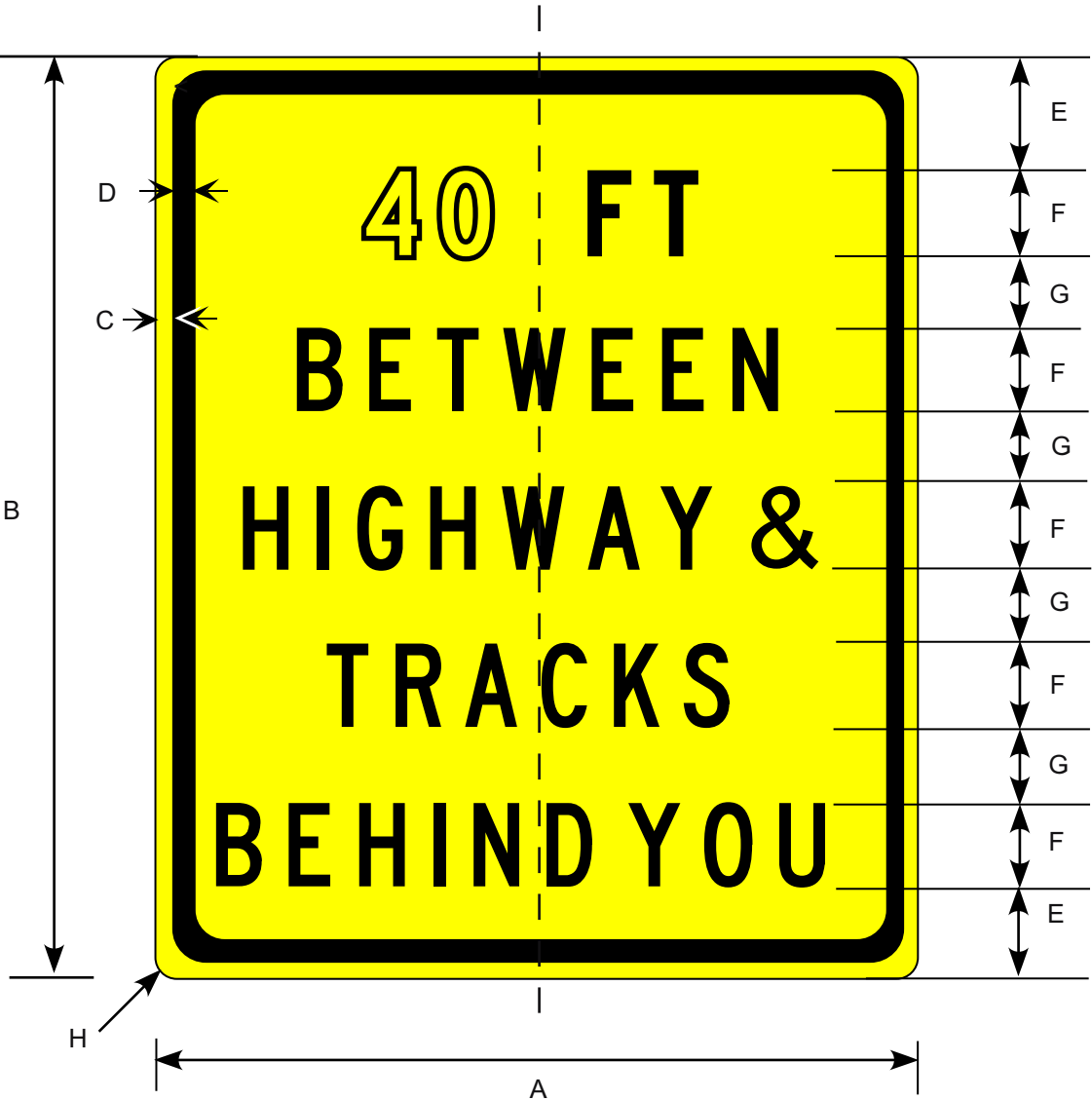

Border and Legend: Black
 Background: Yellow

Road Class	Dimensions (inches)							
	A	B	C	D	E	F	G	H
Conv & Min	36	42	0.63	0.88	4.5	4C	3.25	2.25

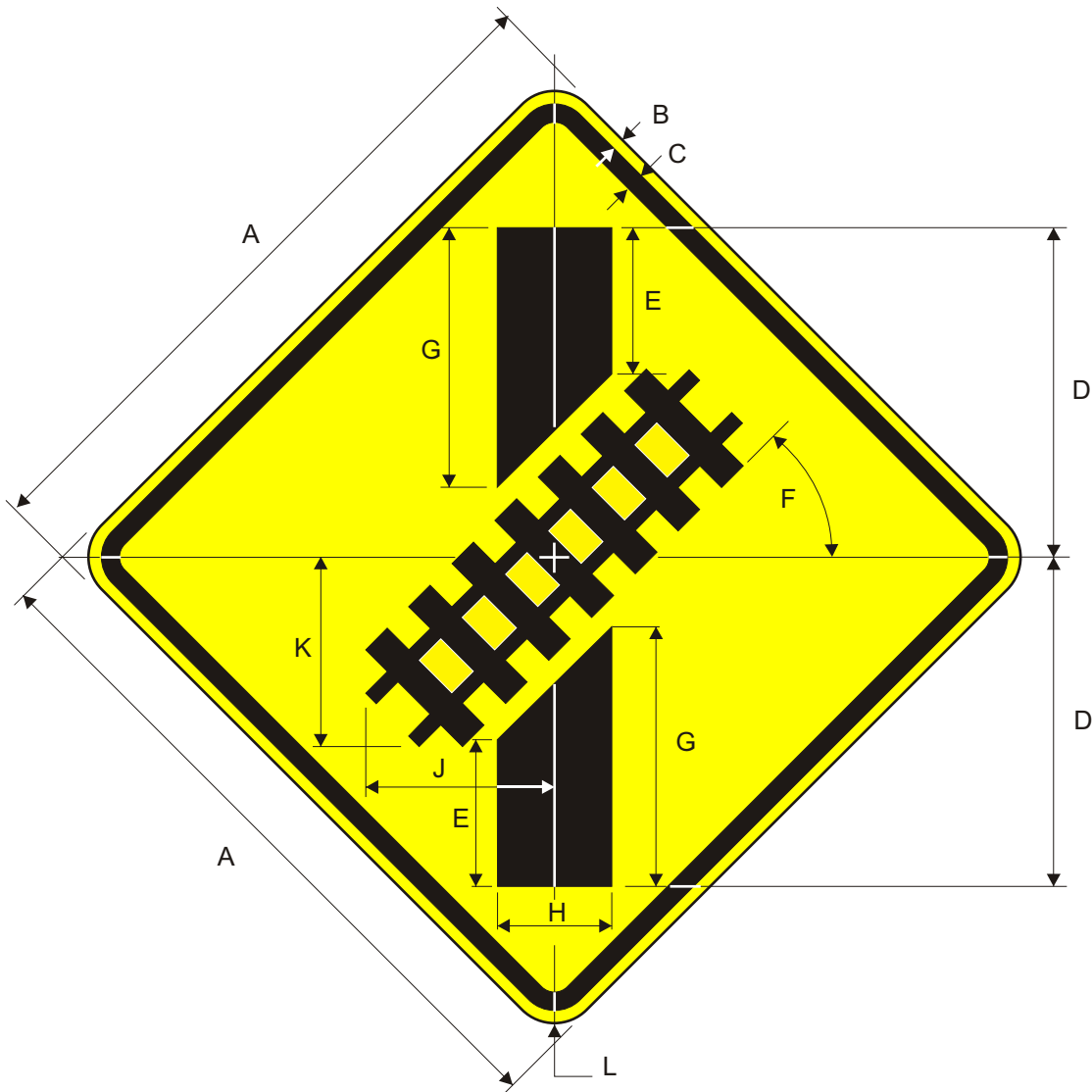

Border and Legend: Black
Background : Yellow

Road Class	Dimensions (inches)										
	A	B	C	D	E	F	G	H	J	K	L
Min.	30	0.5	0.75	14.41	6.36	45°	11.37	5.0	8.21	8.29	1.88
Conv.	36	0.63	0.88	17.29	7.65	45°	13.65	6.0	9.85	9.93	2.25
Expy	48	0.75	1.25	23.06	10.17	45°	18.17	8.0	13.13	13.25	3.0

W10-13

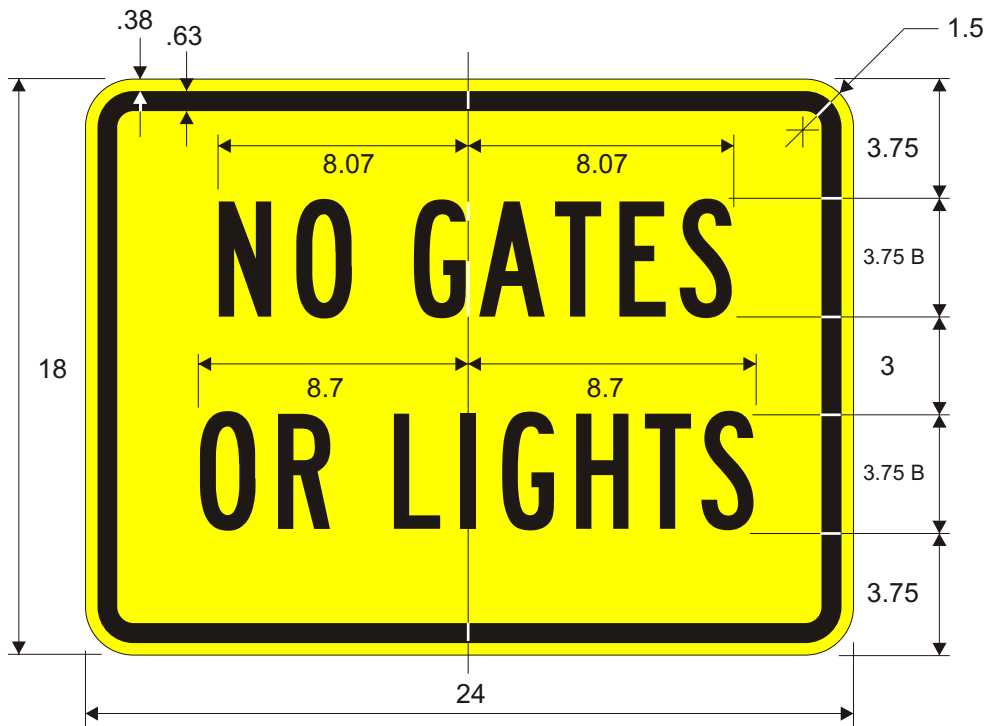

Sign Shall Only be Used With W10-1

Border and Legend: Black
Background : Yellow

W10-14
W10-14A

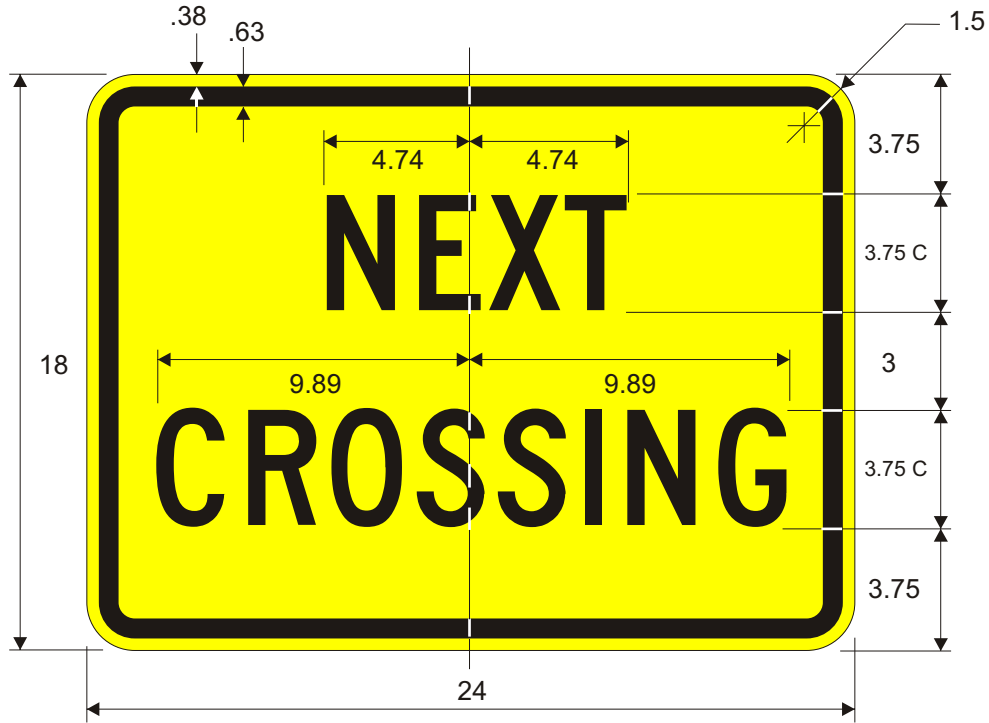

W10-14

For Use With W10-5

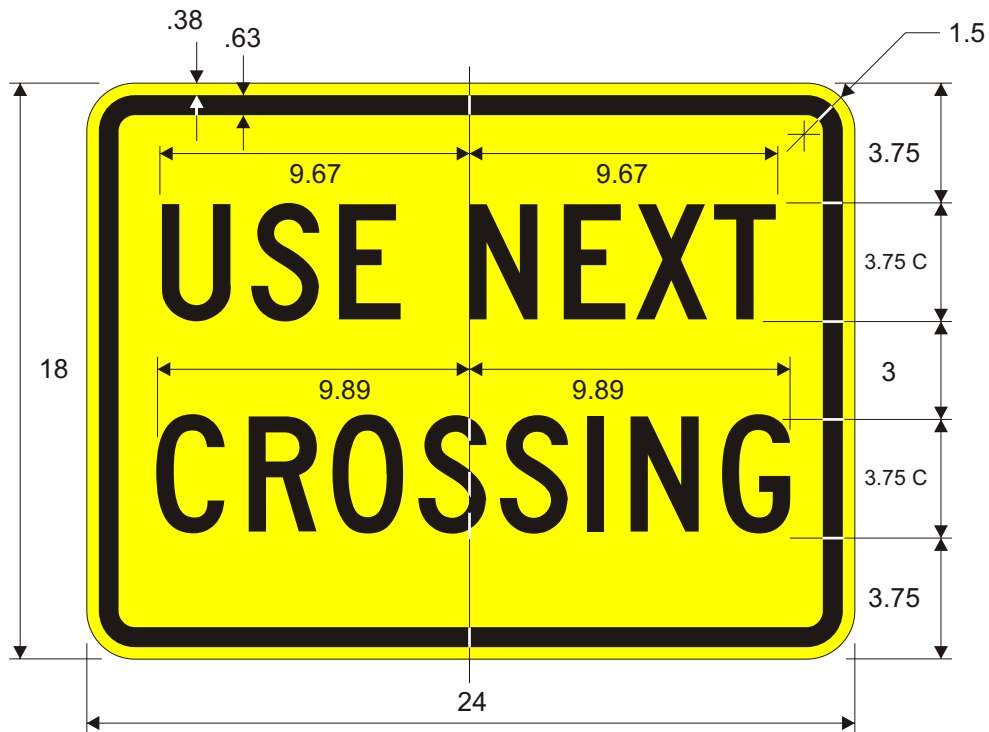

W10-14A

Border and Legend: Black
Background : Yellow

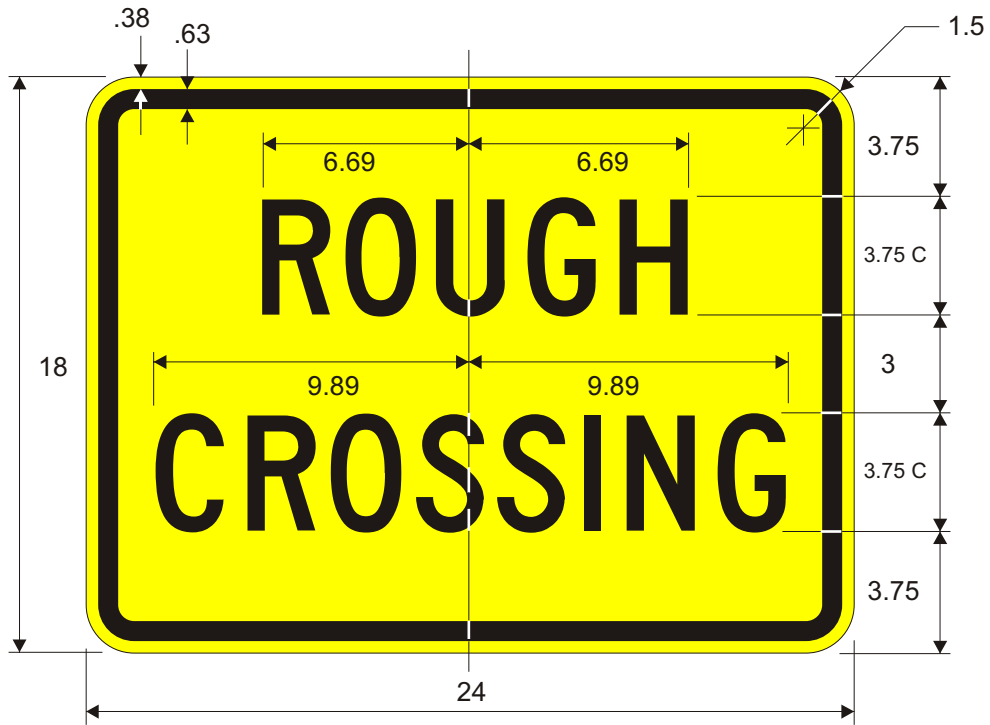

Border and Legend: Black
Background : Yellow

W10-100

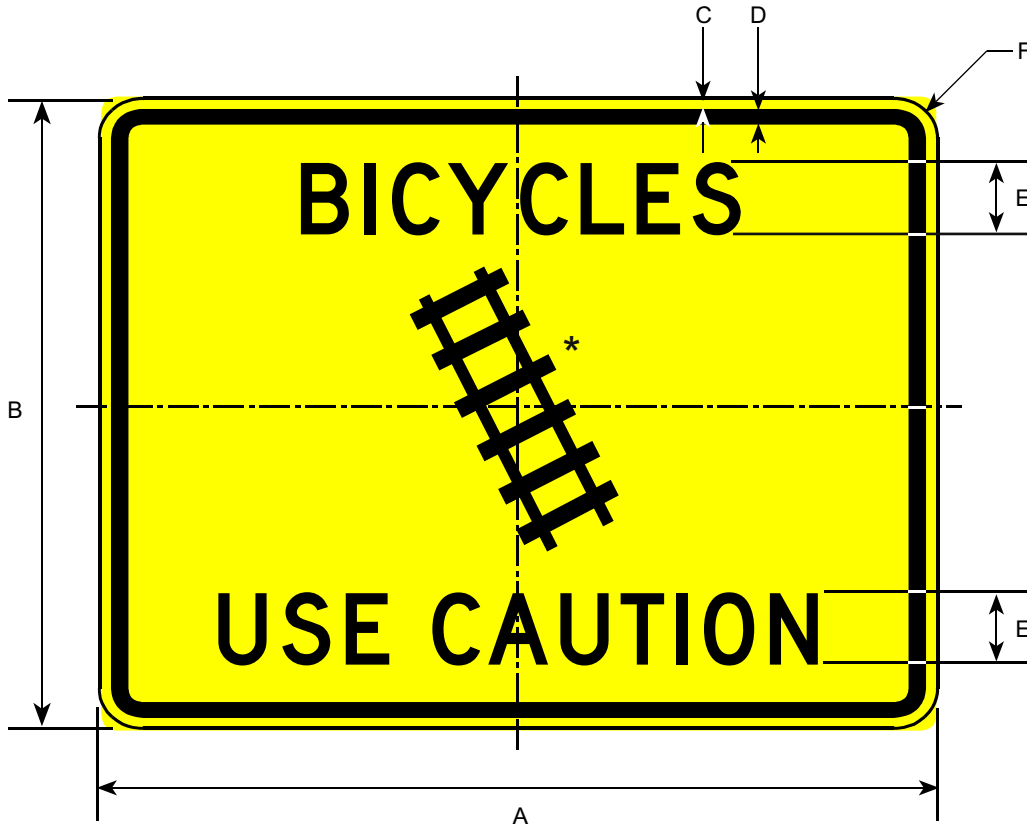

*Make symbol proportional to the graphic shown.

Border and Legend: Black
Background: Yellow

Prior to the 2002 publication of this manual, this sign was numbered W10-5A.

Road Class	Dimensions (inches)					
	A	B	C	D	E	F
Conventional	24	18	0.38	0.63	2D	1.5

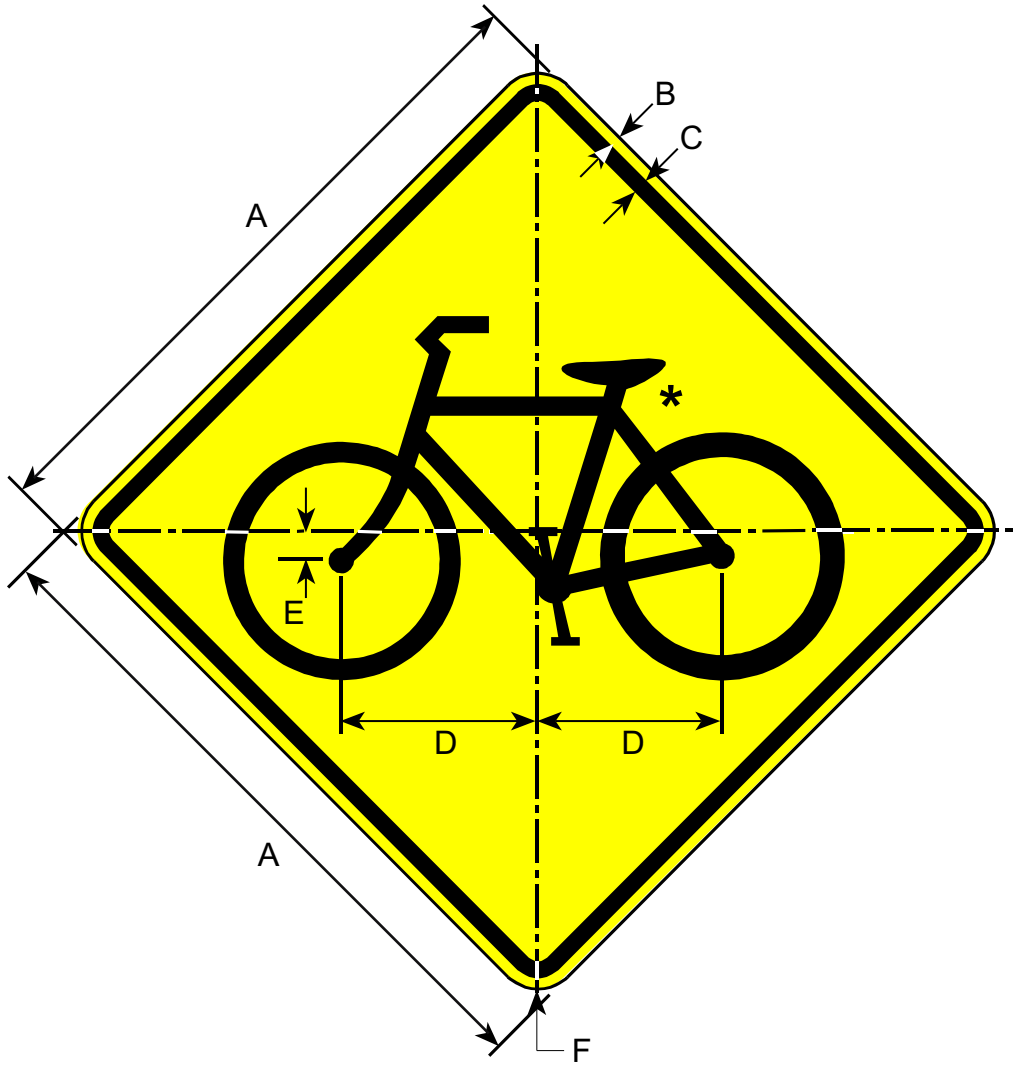

*Make symbol proportional to the graphic shown.

Border and Legend: Black
Background: Yellow

Road Class	Dimensions (inches)					
	A	B	C	D	E	F
Bike	24	0.38	0.63	6.69	0.81	1.50
Minimum	30	0.50	0.75	8.50	1.00	1.88
Conventional	36	0.63	0.88	10.00	1.19	2.25
Expwy	48	0.75	1.25	13.38	1.63	3.00

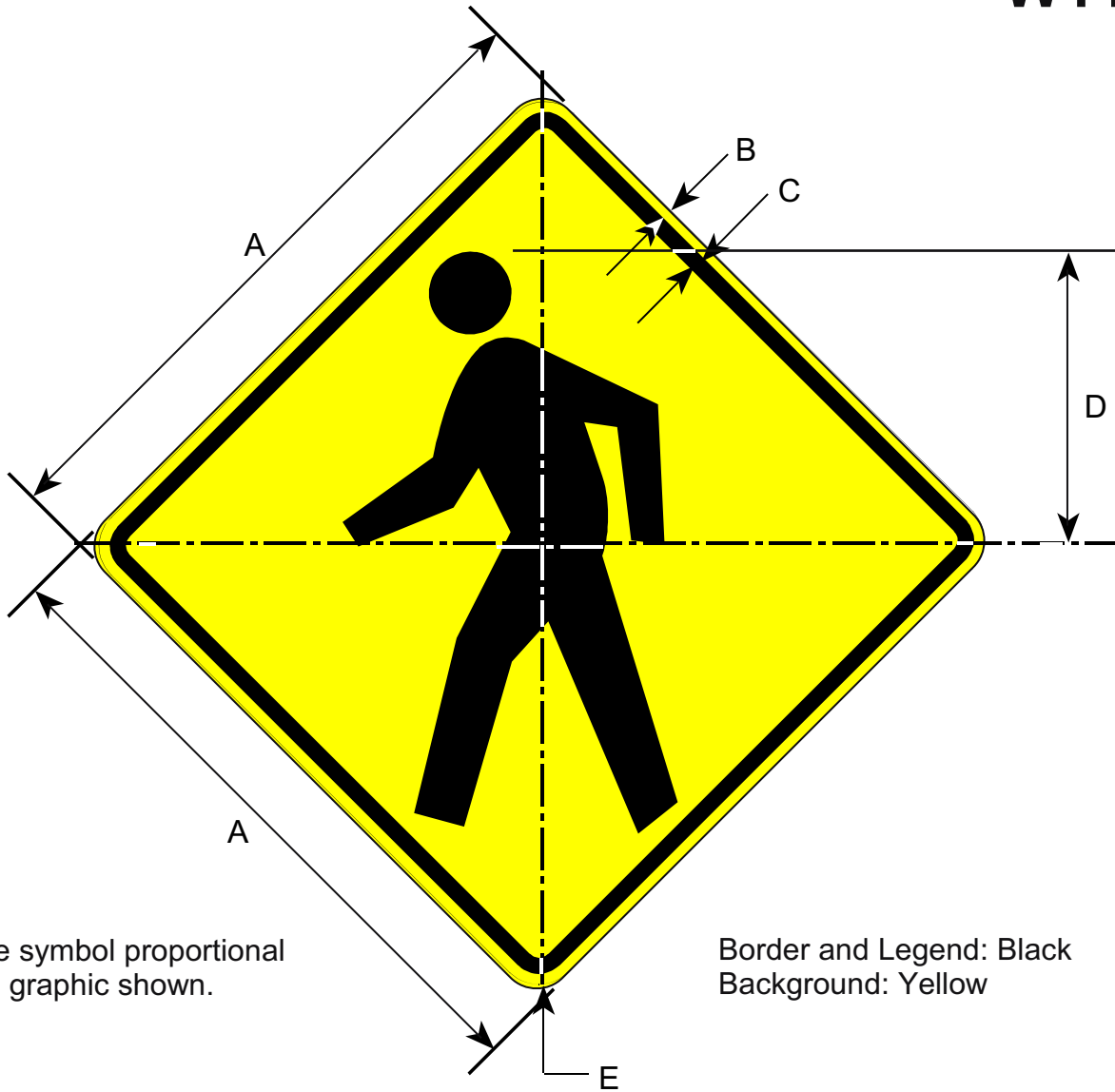

Pedestrian crossing signs used to mark a crossing location shall be supplemented with diagonal downward pointing arrow W16-7P.

Road Class	Dimensions (inches)				
	A	B	C	D	E
Minimum	30	0.50	0.75	14	1.88
Conventional	36	0.63	0.88	16.75	2.25
Expressway	48	0.75	1.25	22	3.0

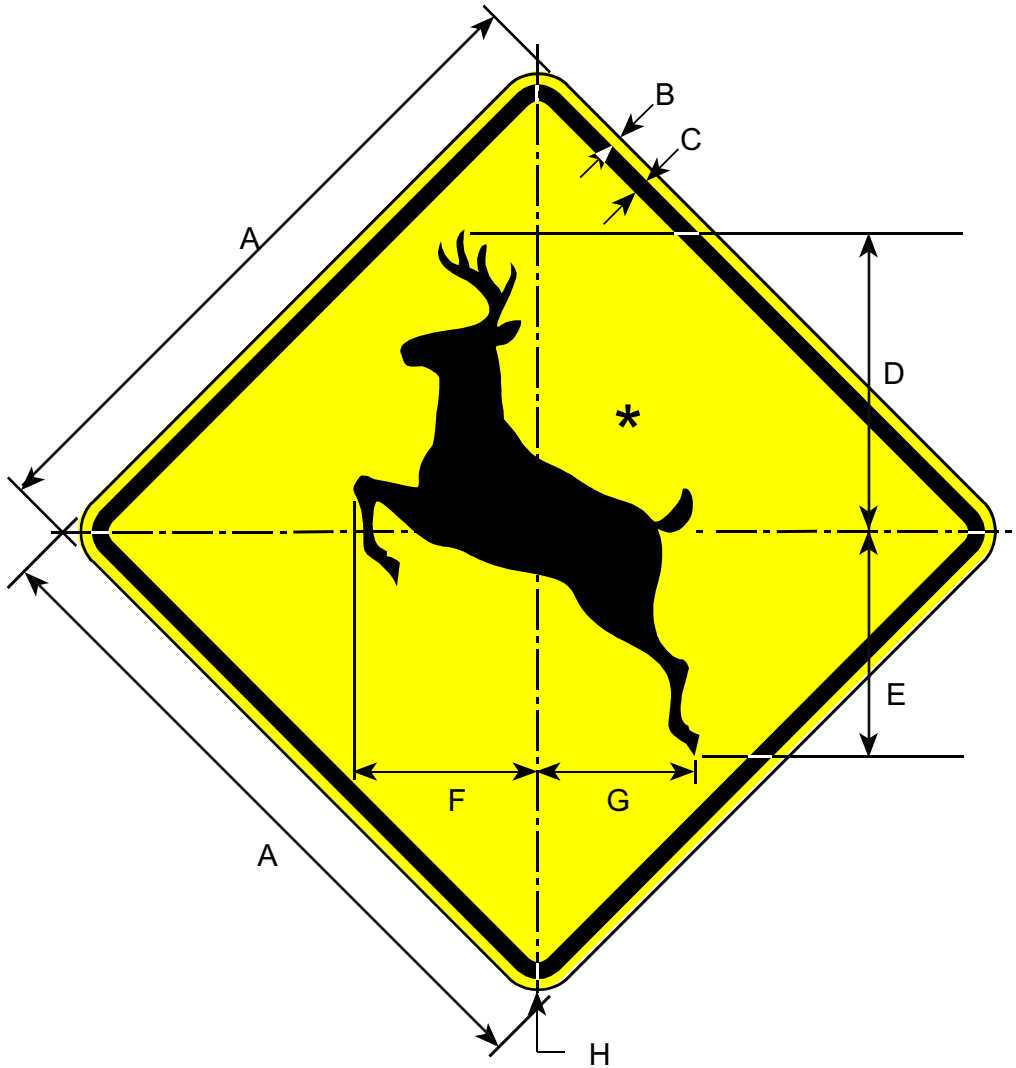

*Make symbol proportional to the graphic shown.

Border and Legend: Black
Background: Yellow

Road Class	Dimensions (inches)							
	A	B	C	D	E	F	G	H
Minimum	30	0.50	0.75	13.50	10.00	7.50	7.50	1.88
Conventional	36	0.63	0.88	16.25	12.00	9.88	9.00	2.25
Expwy/Fwy	48	0.75	1.25	21.25	15.75	13.00	11.75	3.00

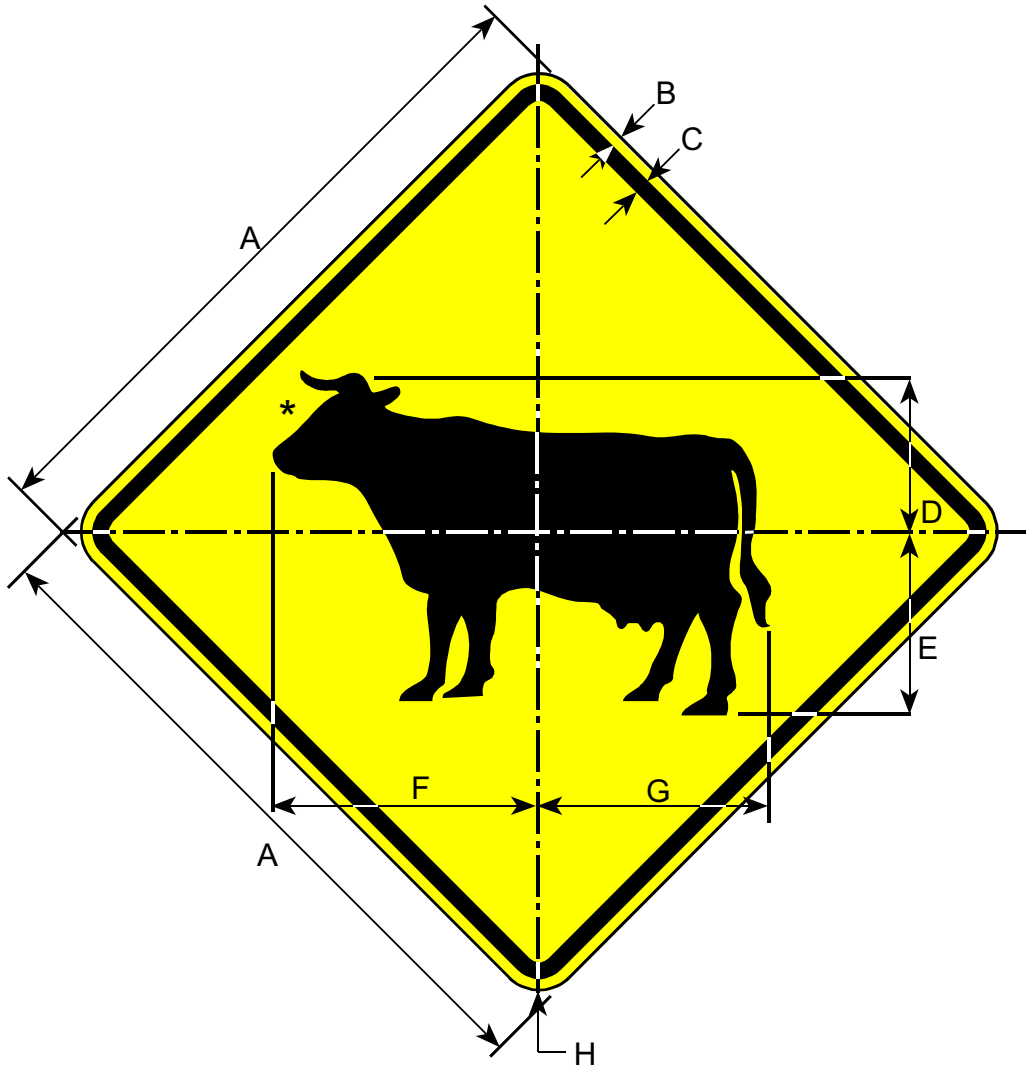

*Make symbol proportional to the graphic shown.

Border and Legend: Black
Background: Yellow

Road Class	Dimensions (inches)							
	A	B	C	D	E	F	G	H
Minimum	30	0.50	0.75	6.00	8.00	11.00	10.50	1.88
Conventional	36	0.63	0.88	7.25	9.63	14.13	12.63	2.25
Expwy/Fwy	48	0.75	1.25	9.50	12.63	18.50	16.63	3.00

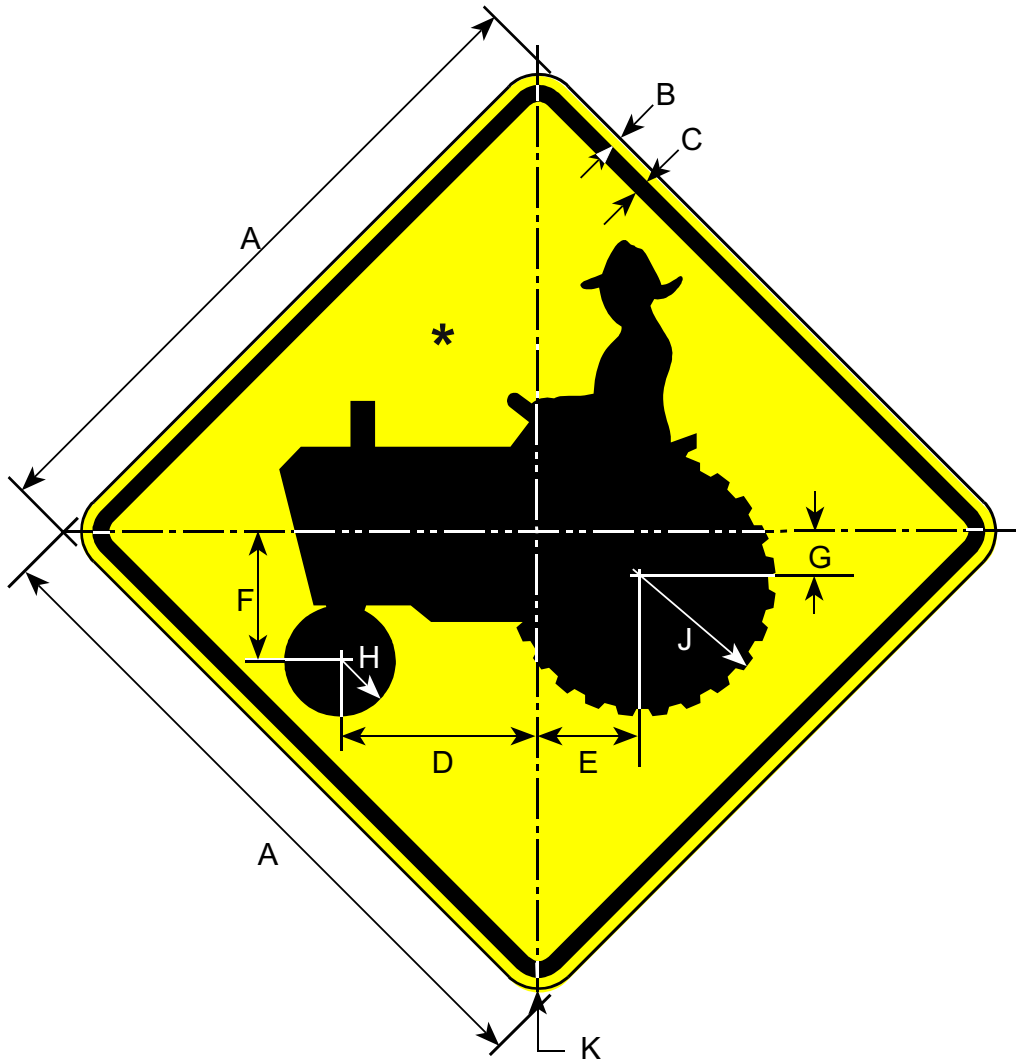

*Make symbol proportional to the graphic shown.

Border and Legend: Black
Background: Yellow

Road Class	Dimensions (inches)									
	A	B	C	D	E	F	G	H	J	K
Minimum	30	0.50	0.75	8.63	4.75	5.50	1.75	2.5	6.00	1.88
Conventional	36	0.63	0.88	10.50	5.75	6.63	2.13	3.0	7.25	2.25
Expwy/Fwy	48	0.75	1.25	13.75	7.50	8.75	2.75	4.0	9.50	3.00

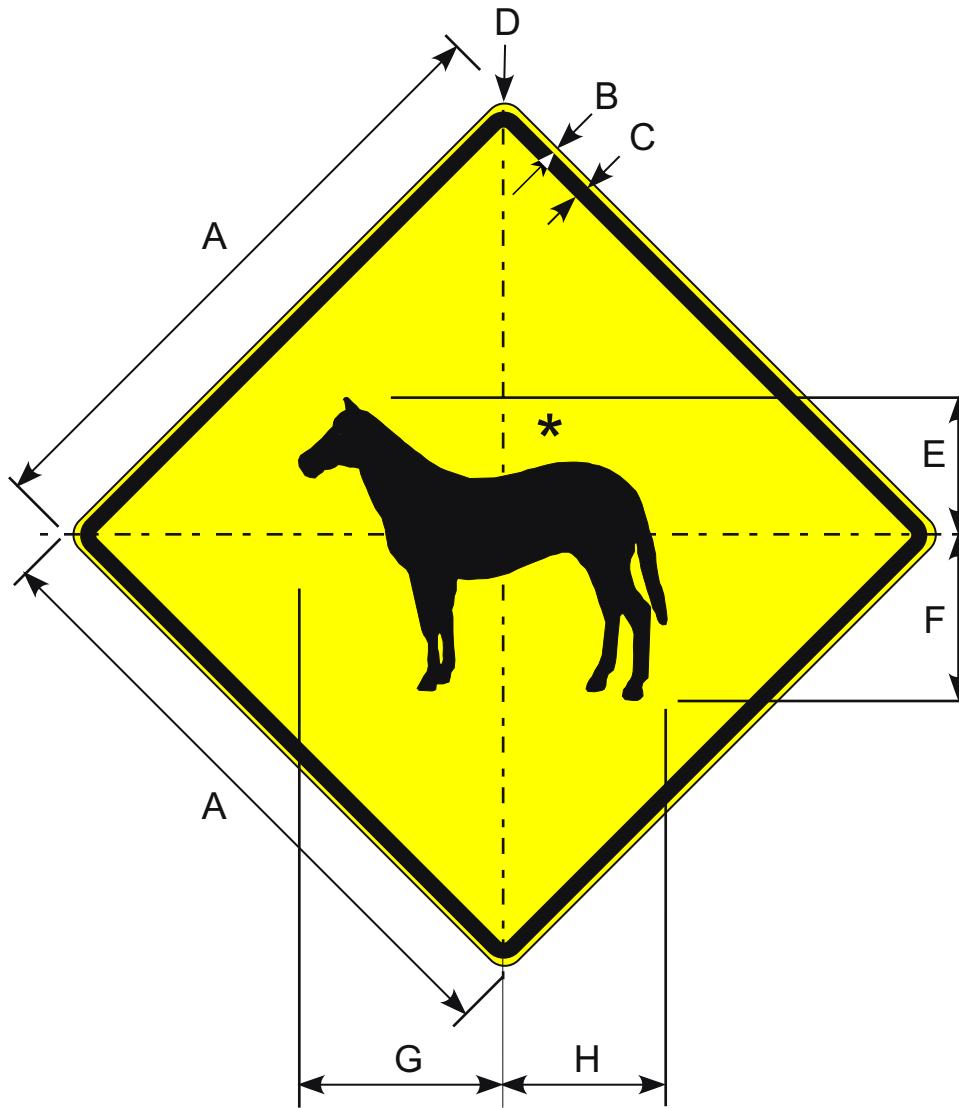

*Make symbol proportional to the graphic shown.

Border and Legend: Black
Background: Yellow

Prior to the 2002 publication of this manual, this sign was numbered W11-11.

Road Class	Dimensions (inches)							
	A	B	C	D	E	F	G	H
Minimum	30	0.50	0.75	1.88	6.63	8.00	9.06	7.88
Conventional	36	0.63	0.88	2.25	7.94	9.63	11.88	9.44
Expwy/Fwy	48	0.75	1.25	3.00	10.56	12.88	15.75	12.56

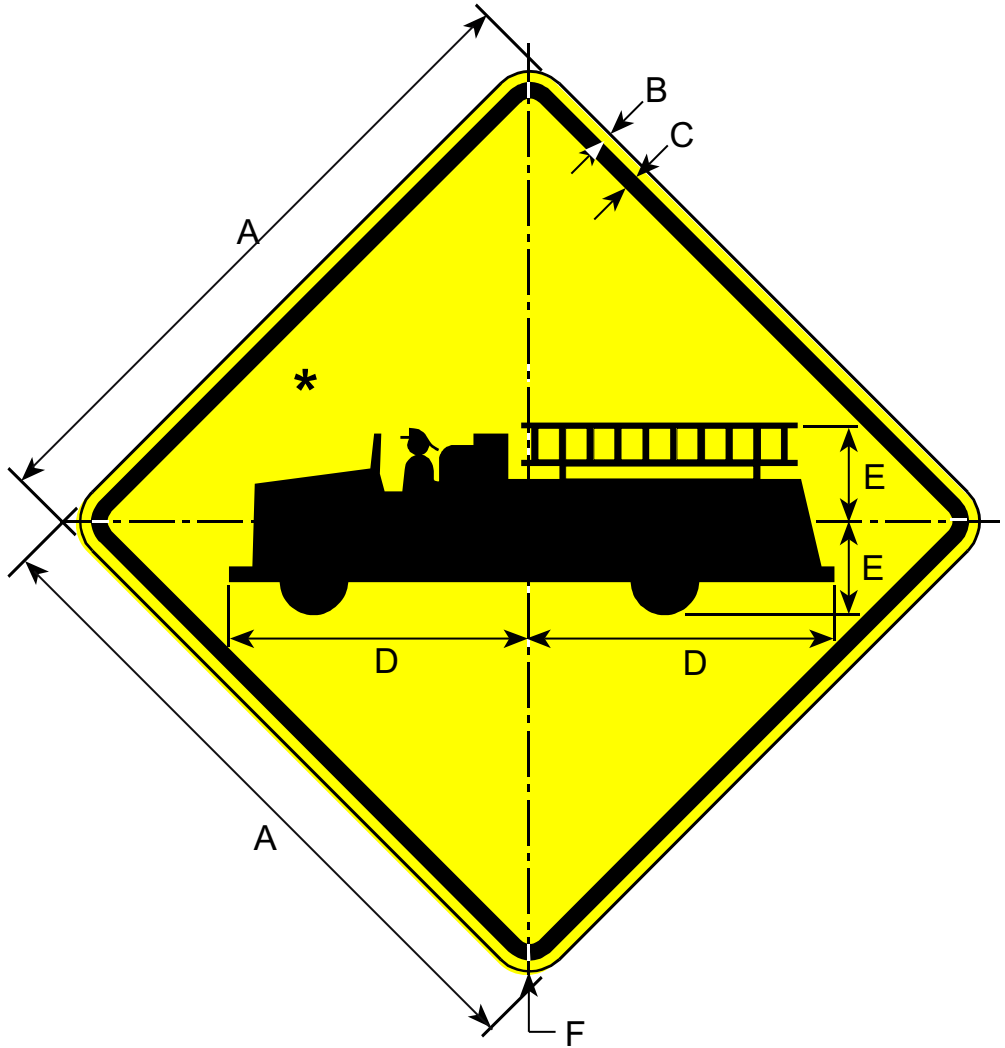

*Make symbol proportional to the graphic shown.

Border and Legend: Black
Background: Yellow

Road Class	Dimensions (inches)					
	A	B	C	D	E	F
Minimum	30	0.50	0.75	13.75	4.38	1.88
Conventional	36	0.63	0.88	16.50	5.25	2.25
Expwy/Fwy	48	0.75	1.25	22.00	7.00	3.00

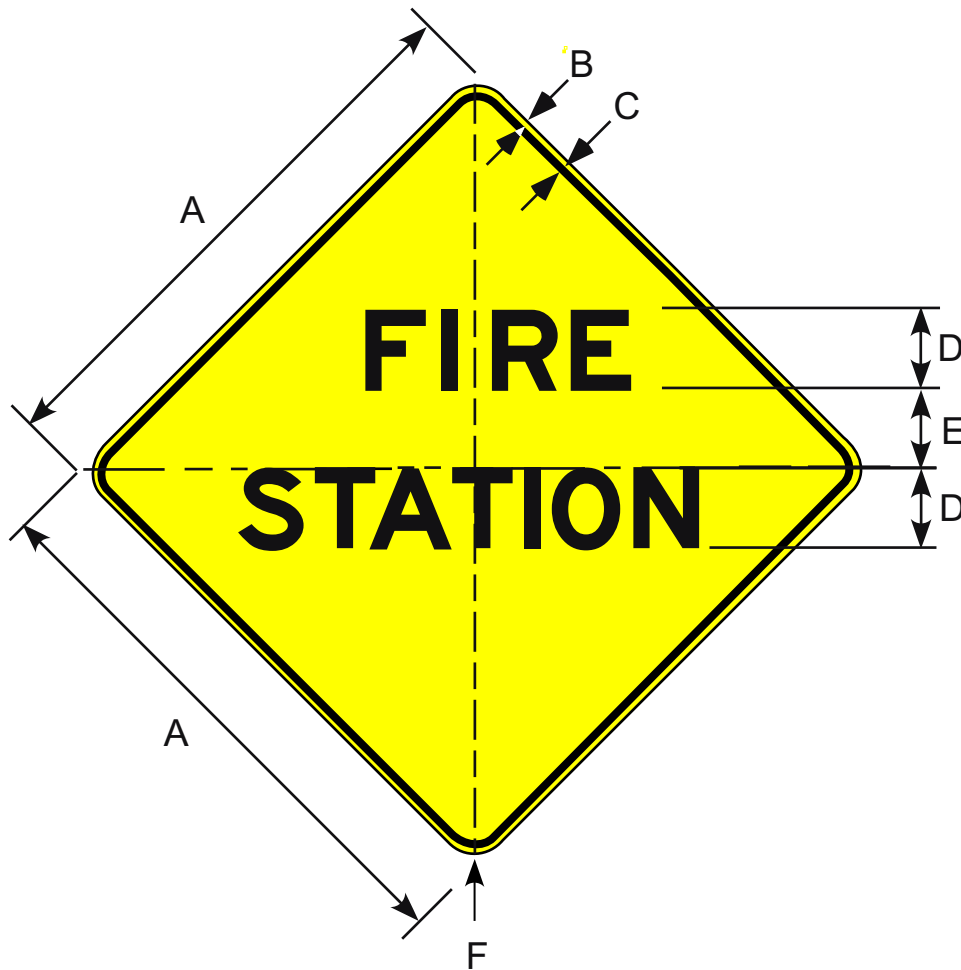

Border and Legend: Black
Background: Yellow

Road Class	Dimensions (inches)					
	A	B	C	D	E	F
Minimum	30	0.50	0.75	5E	5	1.88
Conventional	36	0.63	0.88	6E	6	2.25
Expwy/Fwy	48	0.75	1.25	8E	8	2.25

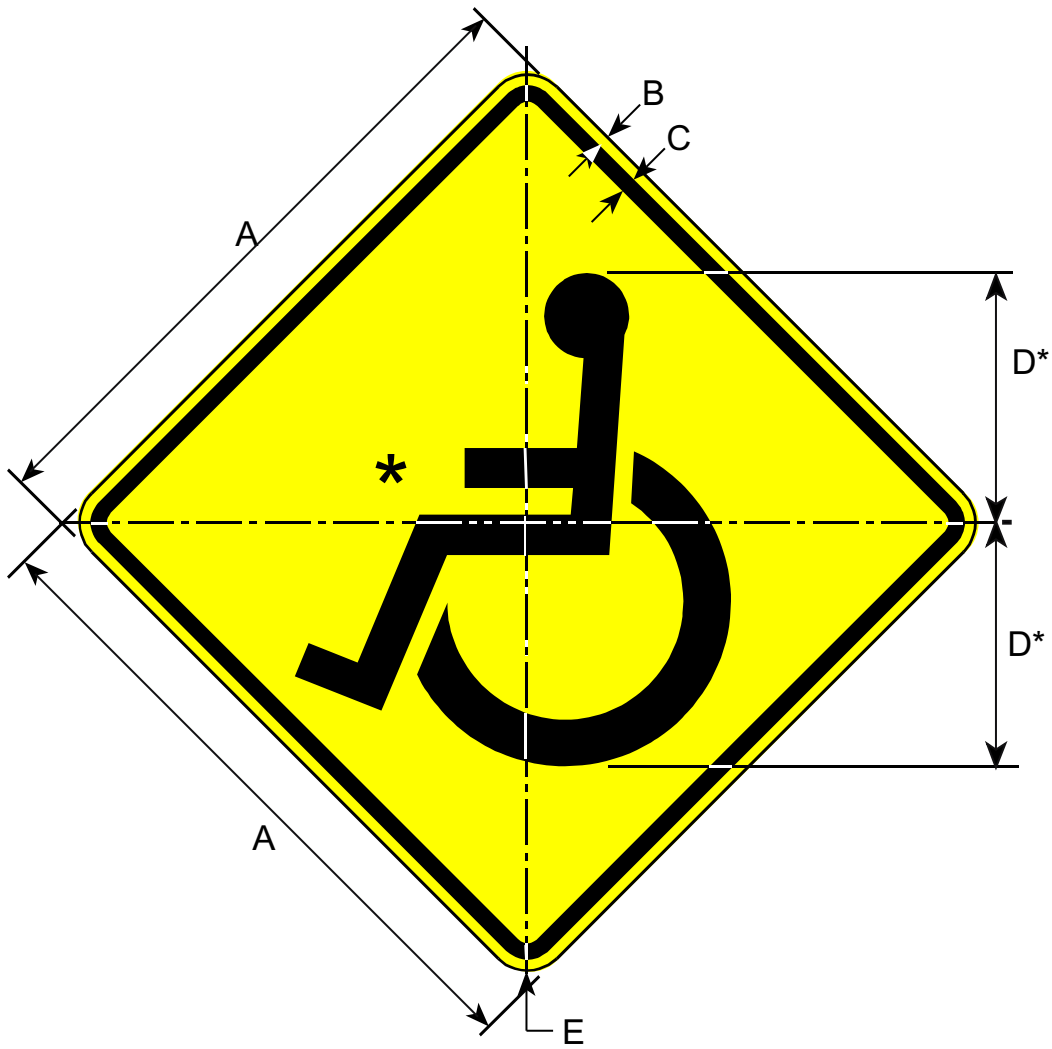

*Make symbol proportional to the graphic shown.

Border and Legend: Black
Background: Yellow

Road Class	Dimensions (inches)				
	A	B	C	D	E
Minimum	30	0.50	0.75	11.25	1.88
Conventional	36	0.63	0.88	13.50	2.25
Expwy/Fwy	48	0.75	1.25	18.00	3.00

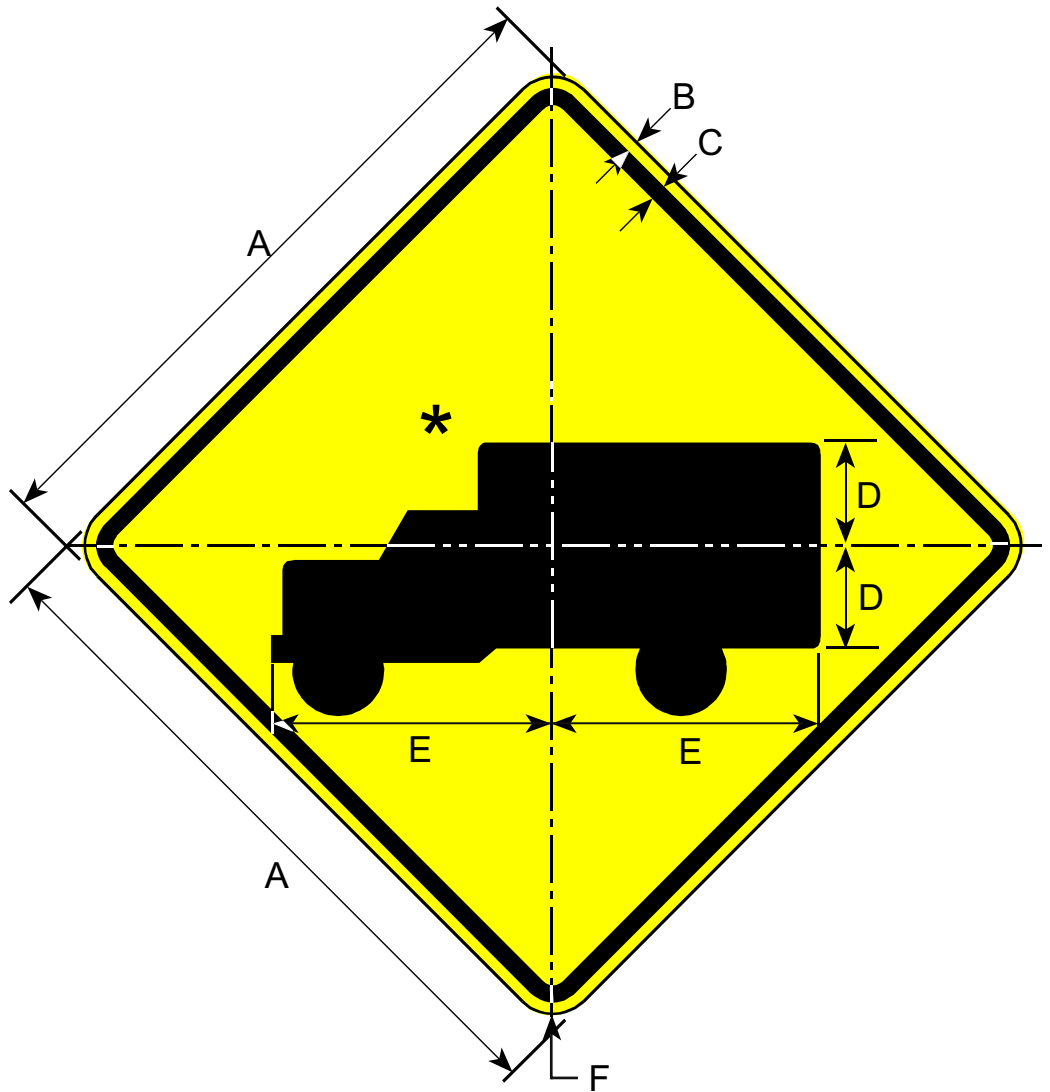

*Make symbol proportional to the graphic shown.

Border and Legend: Black
Background: Yellow

Road Class	Dimensions (inches)					
	A	B	C	D	E	F
Minimum	30	0.50	0.75	9	12	1.88
Conventional	36	0.63	0.88	10	14	2.25
Expwy/Fwy	48	0.75	1.25	14	19	3.00

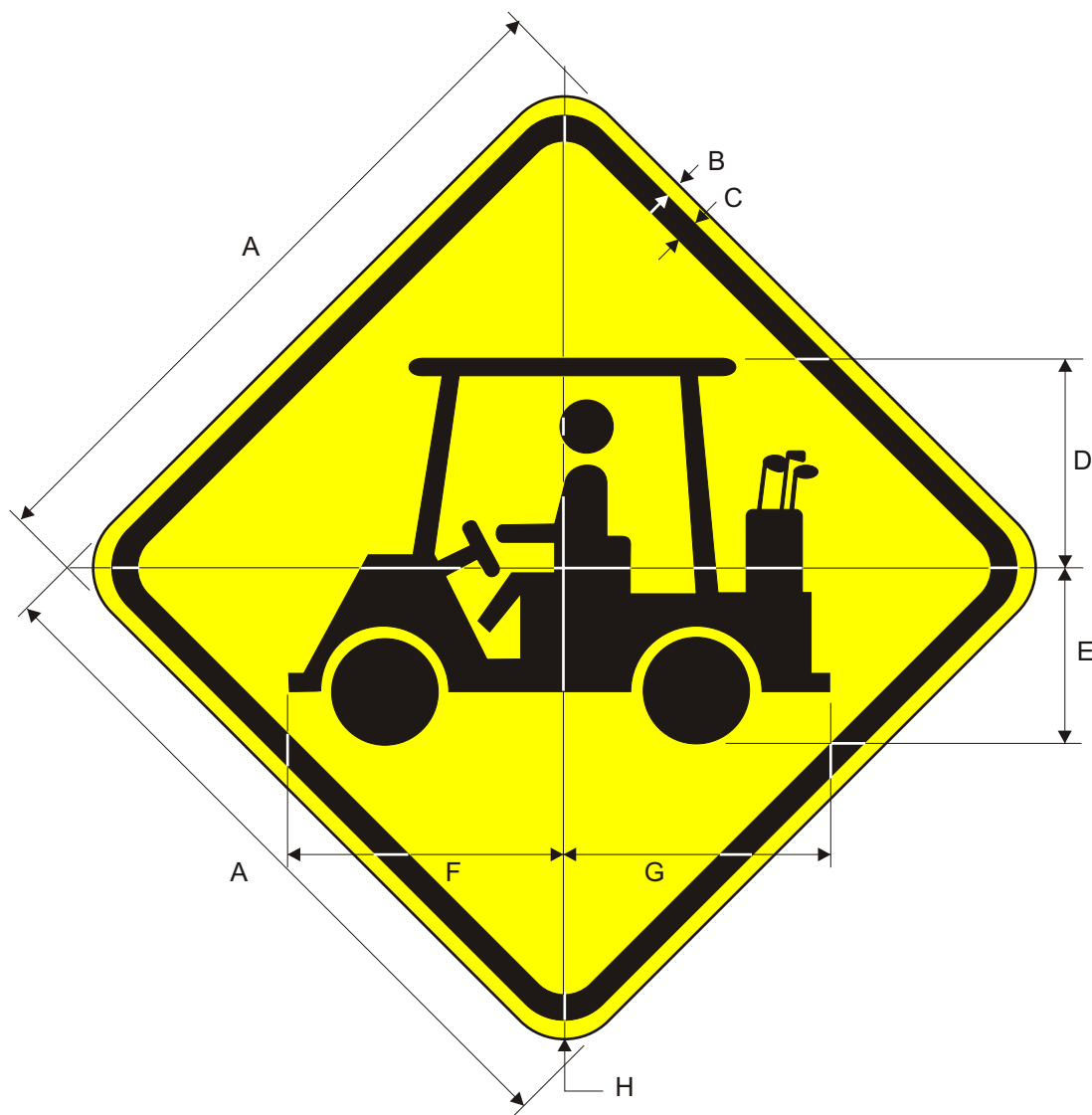

Border and Legend: Black
Background: Yellow

Road Class	Dimensions (inches)							
	A	B	C	D	E	F	G	H
Min.	30	0.50	0.75	9.13	7.61	11.89	11.45	1.88
Conv.	36	0.63	0.88	10.93	9.13	14.25	13.73	2.25
Expy	48	0.75	1.25	14.57	12.13	18.93	18.25	3.0

W11-12P

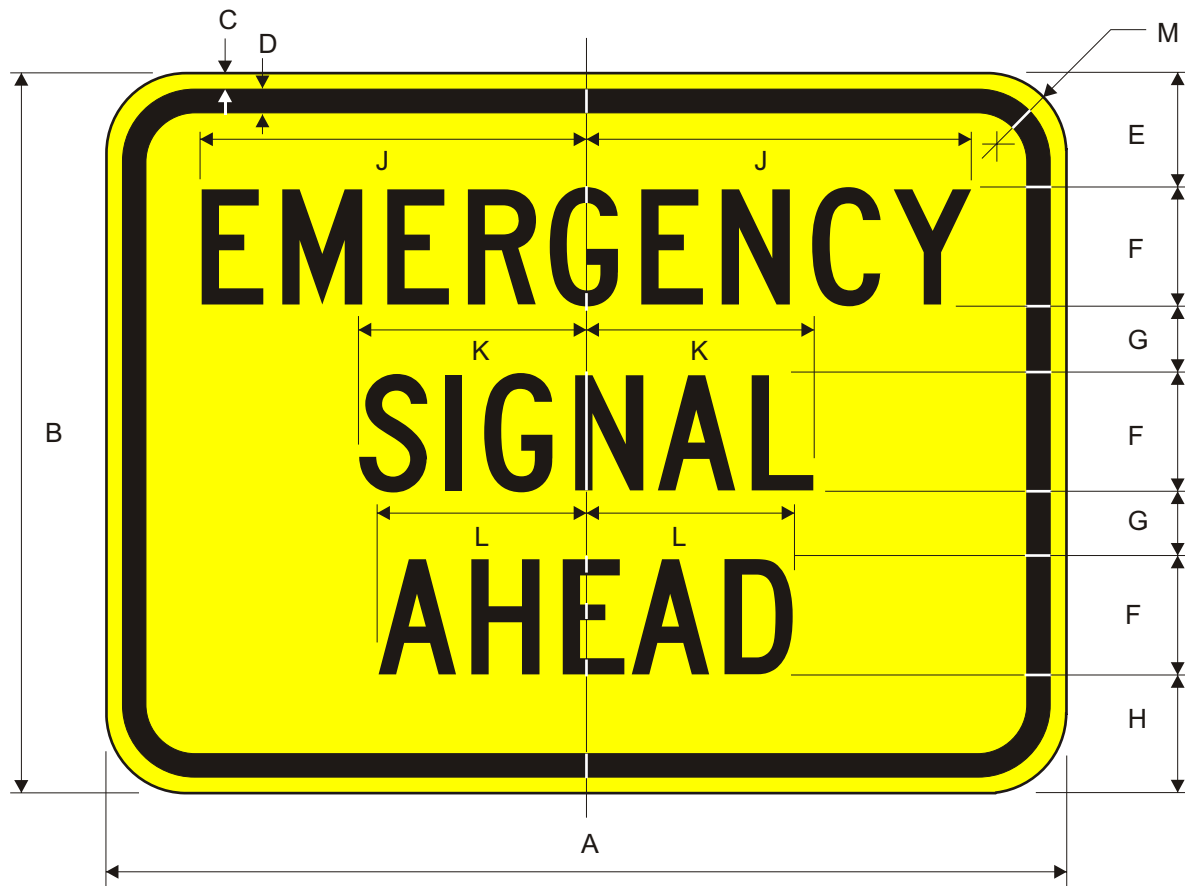

For Use With W11-8 "EMERGENCY VEHICLE"

Border and Legend: Black
Background: Yellow

Road Class	Dimensions (inches)											
	A	B	C	D	E	F	G	H	J	K	L	M
Min.	30	24	0.50	0.75	4.0	4C	2.0	4.0	12.89	7.61	6.99	1.88
Conv.	36	30	0.63	0.88	5.63	4.25C	3	5.63	14.19	8.37	7.67	2.25

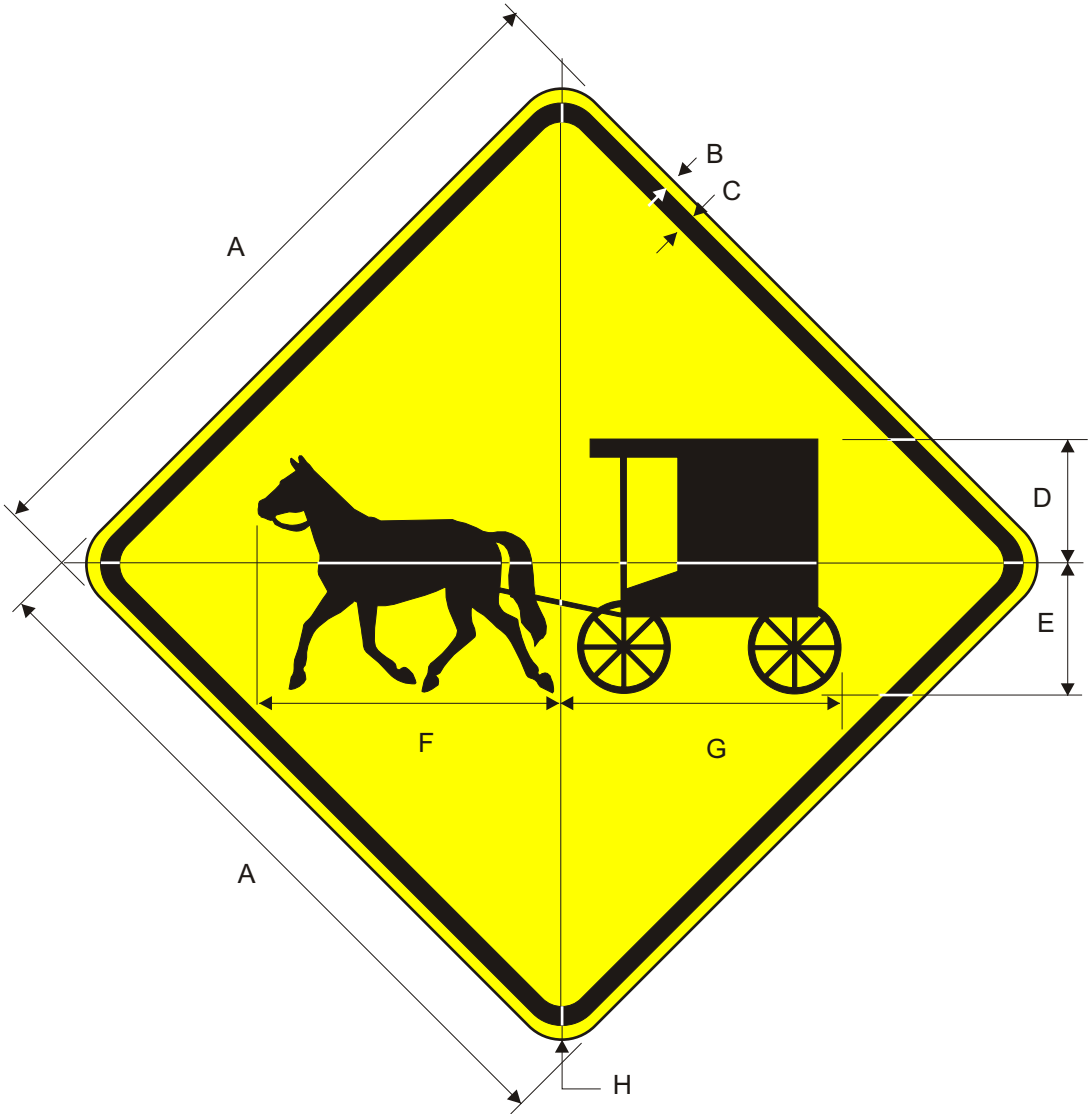

Border and Legend: Black
Background: Yellow

Road Class	Dimensions (inches)							
	A	B	C	D	E	F	G	H
Min.	30	0.50	0.75	5.40	5.56	13	11.97	1.88
Conv.	36	0.63	0.88	6.48	6.69	15.61	14.37	2.25
Expy.	48	0.75	1.25	8.65	8.93	20.82	19.17	3.0

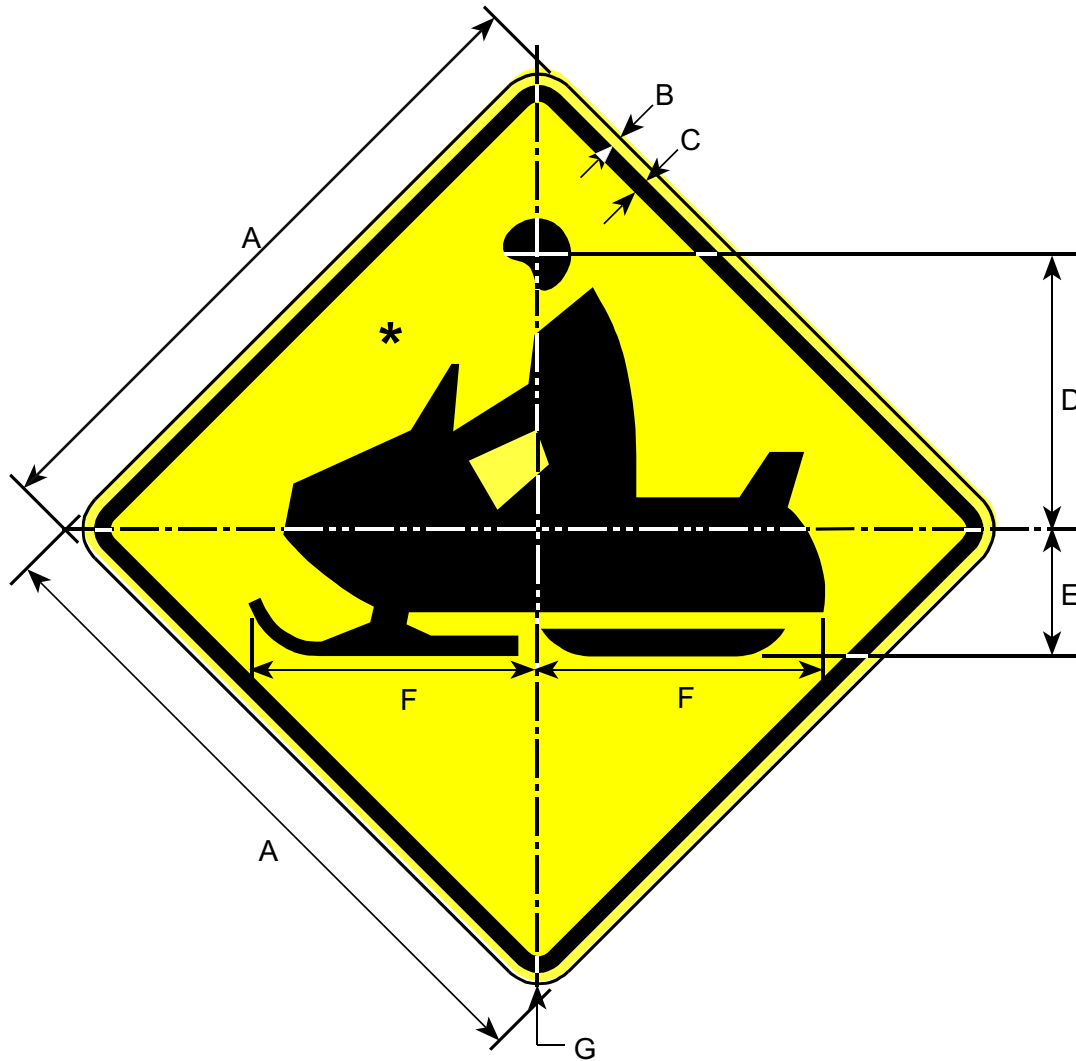

*Make symbol proportional to the graphic shown.

Border and Legend: Black
Background: Yellow

Prior to the 2002 publication of this manual, this sign was numbered W11-6.

Road Class	Dimensions (inches)						
	A	B	C	D	E	F	G
Minimum	30	0.50	0.75	11.75	5.56	12.75	1.88
Conventional	36	0.63	0.88	14.13	6.75	15.25	2.25

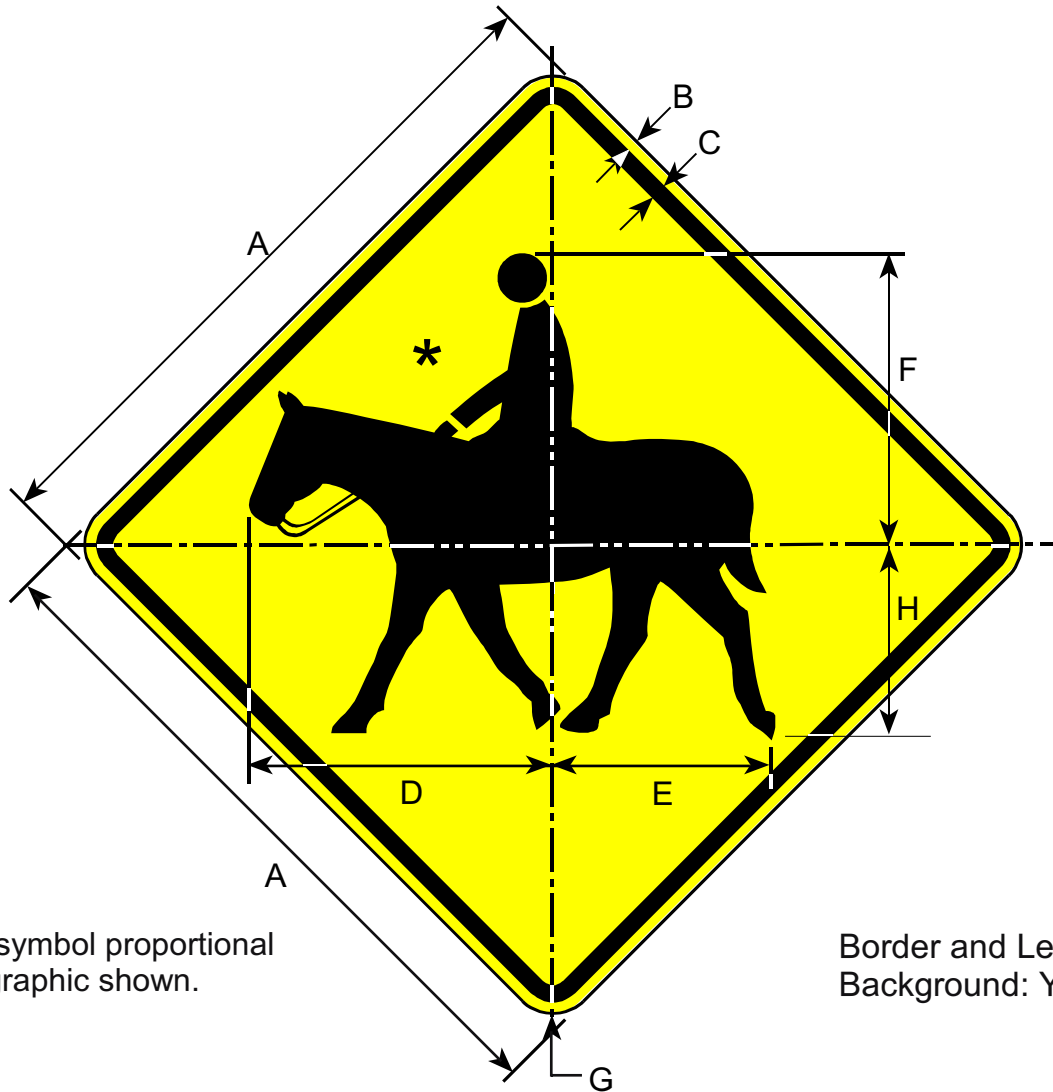

*Make symbol proportional to the graphic shown.

Border and Legend: Black
Background: Yellow

Prior to the 2002 publication of this manual, this sign was numbered W11-7.

Road Class	Dimensions (inches)							
	A	B	C	D	E	F	G	H
Minimum	30	0.50	0.75	13	10	13	1.88	8.5
Conventional	36	0.63	0.88	15.5	12	15.63	2.25	10.25
Expwy/Fwy	48	0.75	1.25	21	16	21	3	13.75

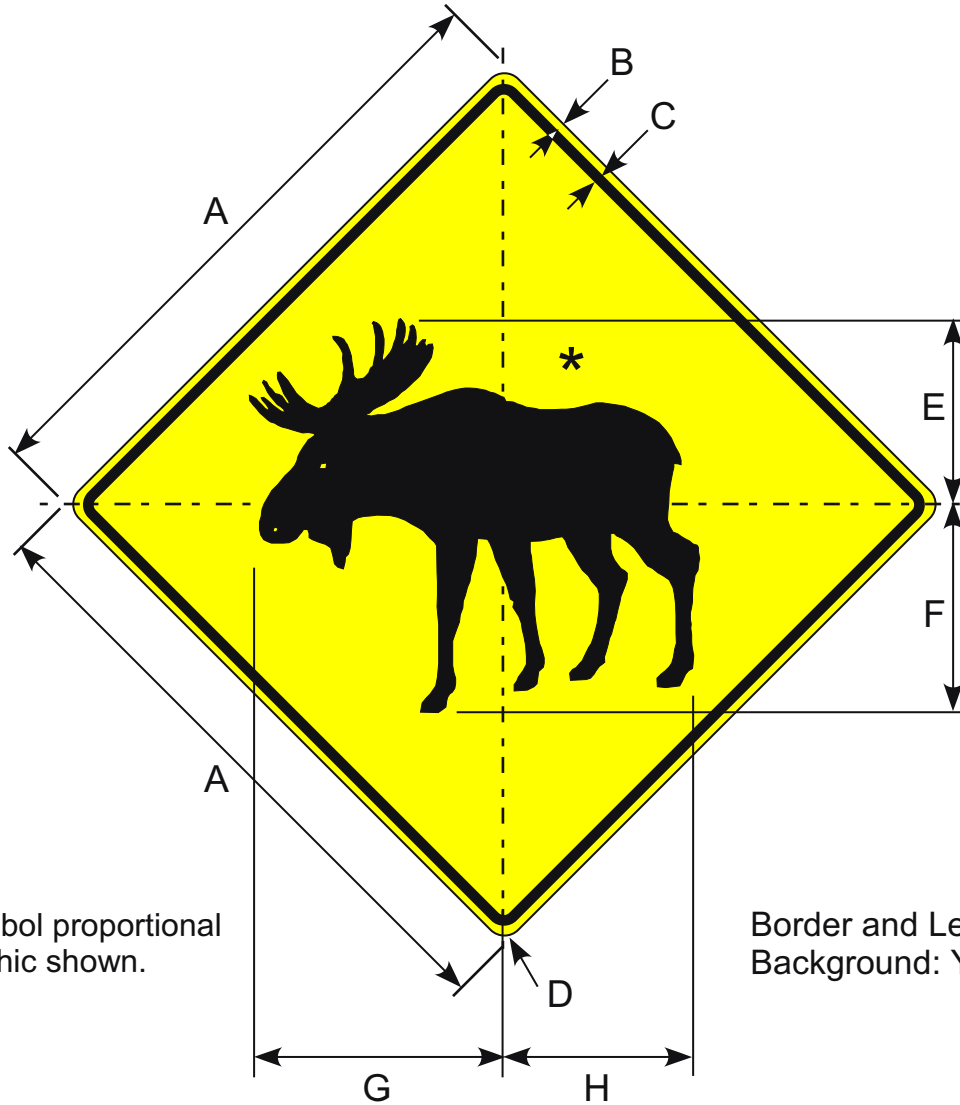

*Make symbol proportional to the graphic shown.

Border and Legend: Black
Background: Yellow

Prior to the 2002 publication of this manual, this sign was numbered W11-12.

Road Class	Dimensions (inches)							
	A	B	C	D	E	F	G	H
Minimum	30	0.50	0.75	1.88	8.56	8.88	11.38	8.75
Conventional	36	0.63	0.88	2.25	10.25	10.63	13.63	10.50
Expwy/Fwy	48	0.75	1.25	3.00	13.63	14.13	18.13	14.00

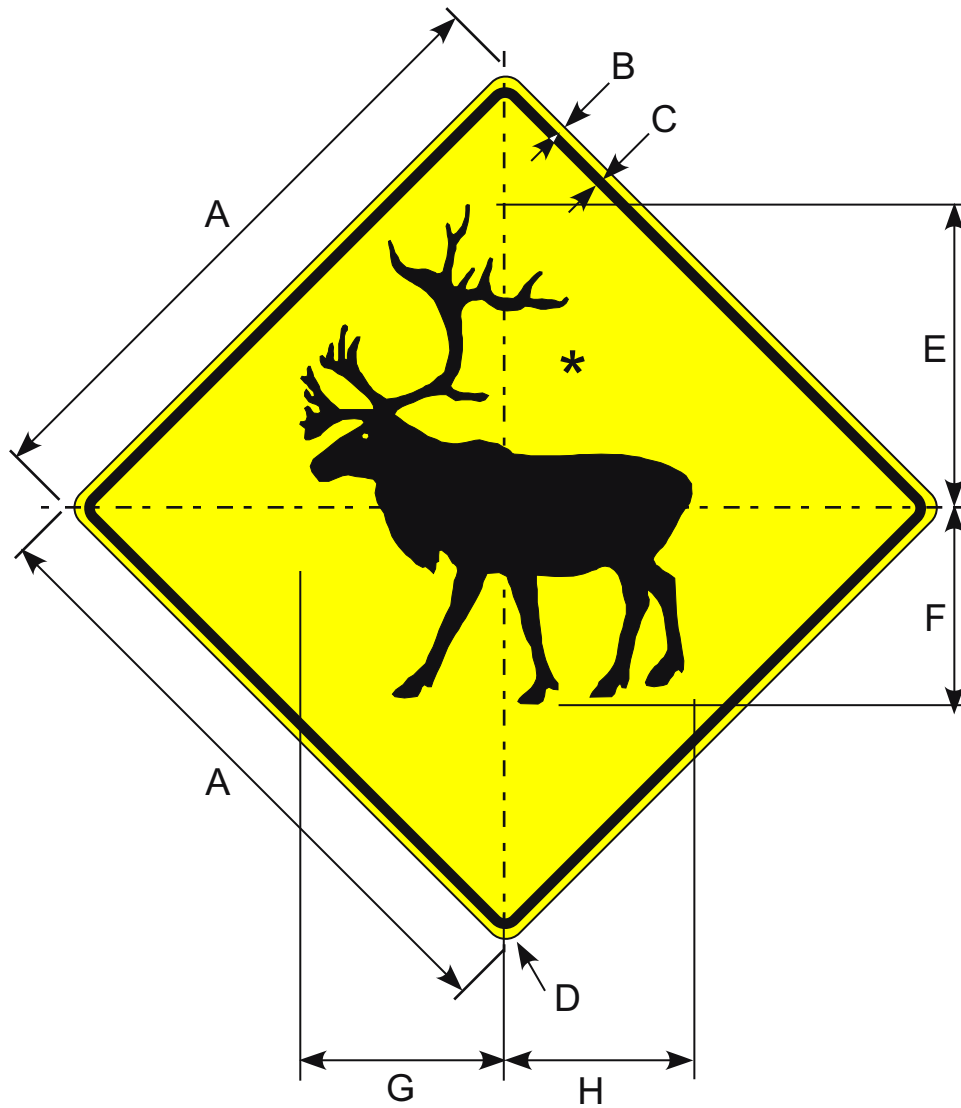

*Make symbol proportional to the graphic shown.

Border and Legend: Black
Background: Yellow

Prior to the 2002 publication of this manual, this sign was numbered W11-13.

Road Class	Dimensions (inches)							
	A	B	C	D	E	F	G	H
Minimum	30	0.50	0.75	1.88	13.31	9.25	8.63	7.69
Conventional	36	0.63	0.88	2.25	16.00	11.06	10.31	9.20
Expwy/Fwy	48	0.75	1.25	3.00	21.25	14.75	13.75	12.26

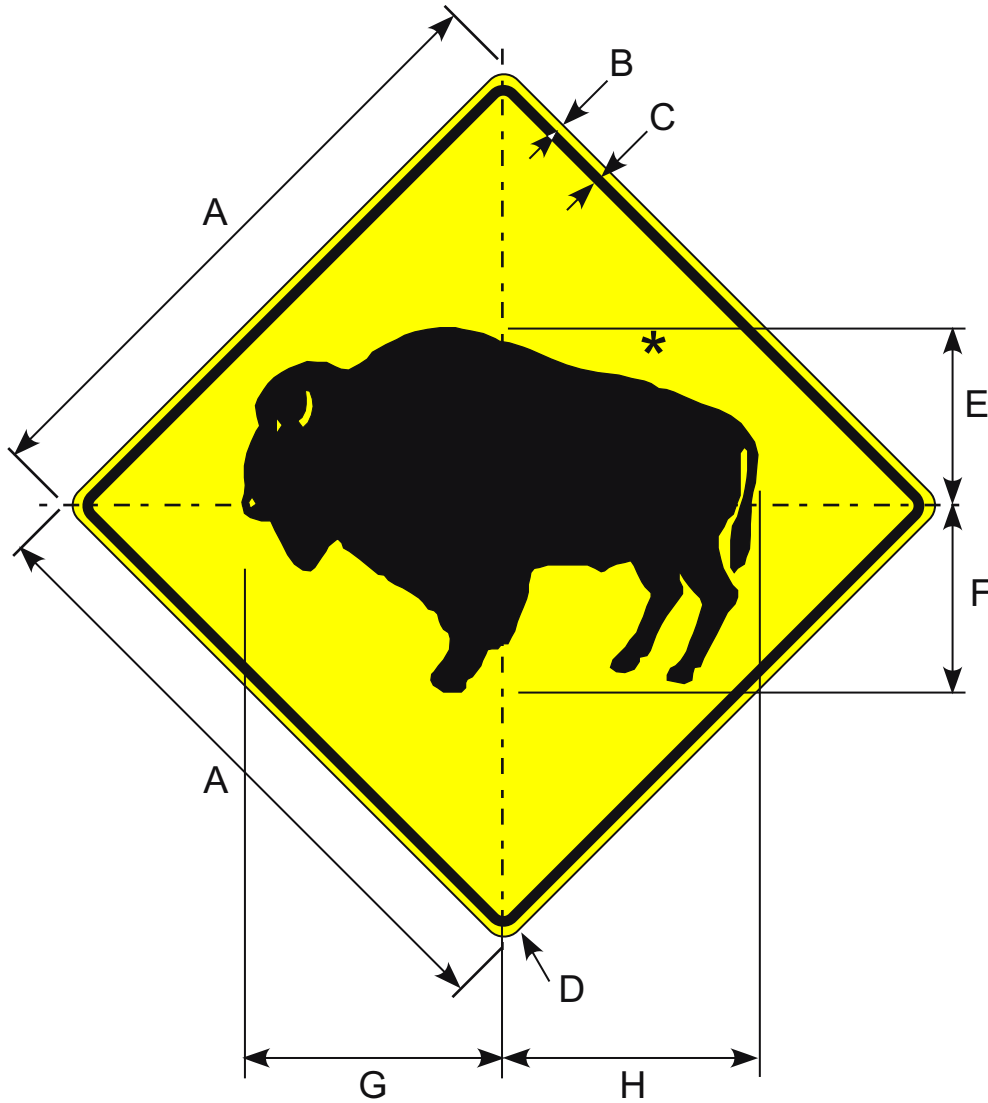

*Make symbol proportional to the graphic shown.

Border and Legend: Black
Background: Yellow

Prior to the 2002 publication of this manual, this sign was numbered W11-14.

Road Class	Dimensions (inches)						
	A	B	C	D	E	F	G
Minimum	30	0.50	0.75	1.88	7.19	8.25	11.88
Conventional	36	0.63	0.88	2.25	8.38	10.25	14.25
Expwy/Fwy	48	0.75	1.25	3.00	11.63	13.63	19.00

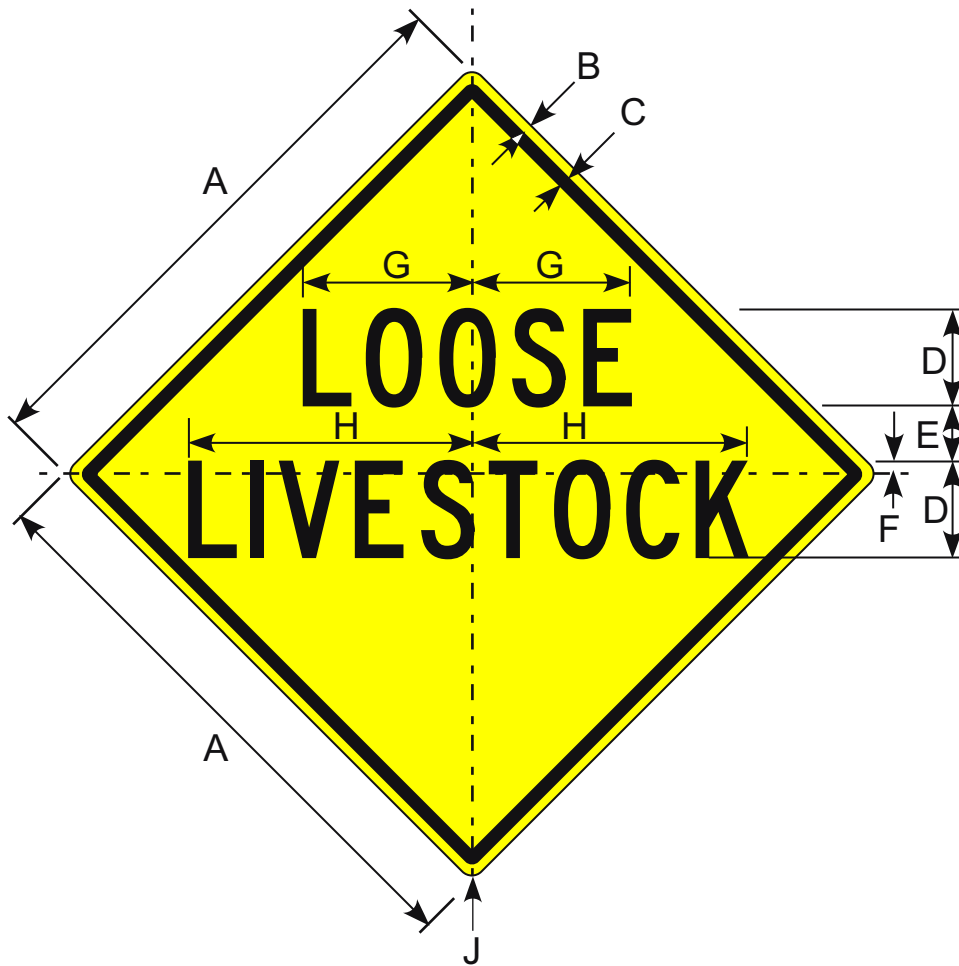

Border and Legend: Black
Background: Yellow

Prior to the 2002 publication of this manual, this sign was numbered W11-20.

Road Class	Dimensions (inches)									
	A	B	C	D	E	F	G	H	J	
Minimum	30	0.50	0.75	4D	3.00	0.50	8.19	13.94	1.88	
Conventional	36	0.63	0.88	6C	3.50	0.75	10.25	17.00	2.25	

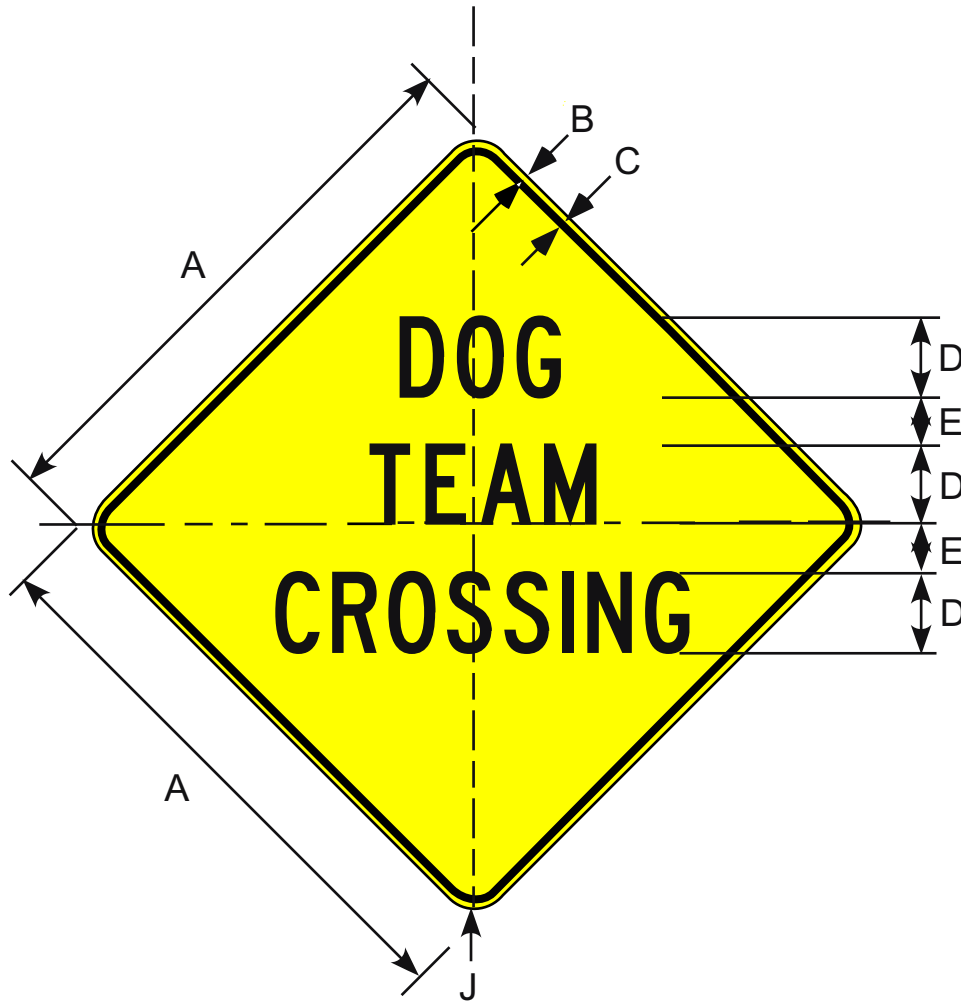

Border and Legend: Black
 Background: Yellow

Road Class	Dimensions (inches)					
	A	B	C	D	E	J
Minimum	30	0.50	0.75	4C	2.50	1.88
Conventional	36	0.63	0.88	5C	3.00	2.25

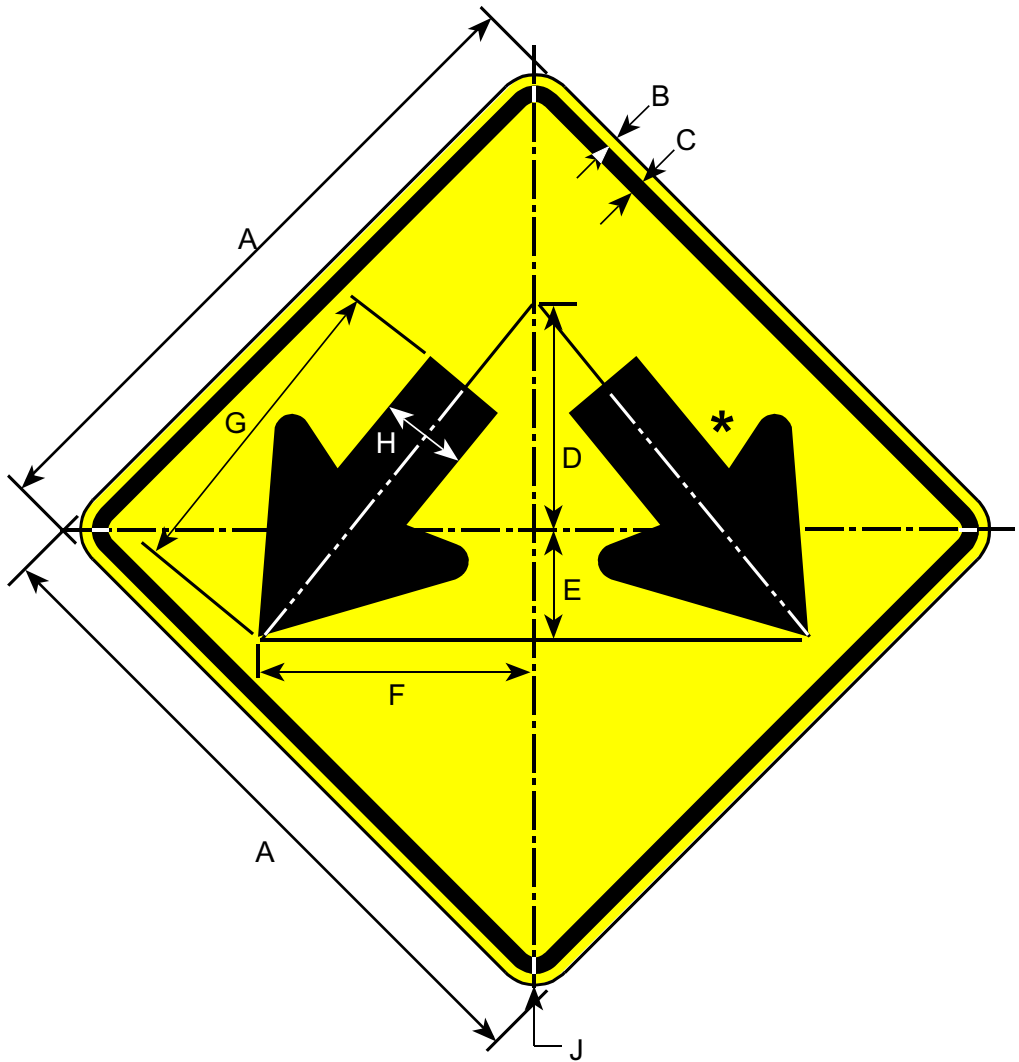

Border and Legend: Black
Background: Yellow

* See Appendix B-1 for Standard Arrow Details.

Road Class	Dimensions (inches)								
	A	B	C	D	E	F	G	H	J
Minimum	30	0.50	0.75	10	5.25	12.38	14.69	4.0	1.88
Conventional	36	0.63	0.88	12	6.13	14.63	17.5	4.75	2.25

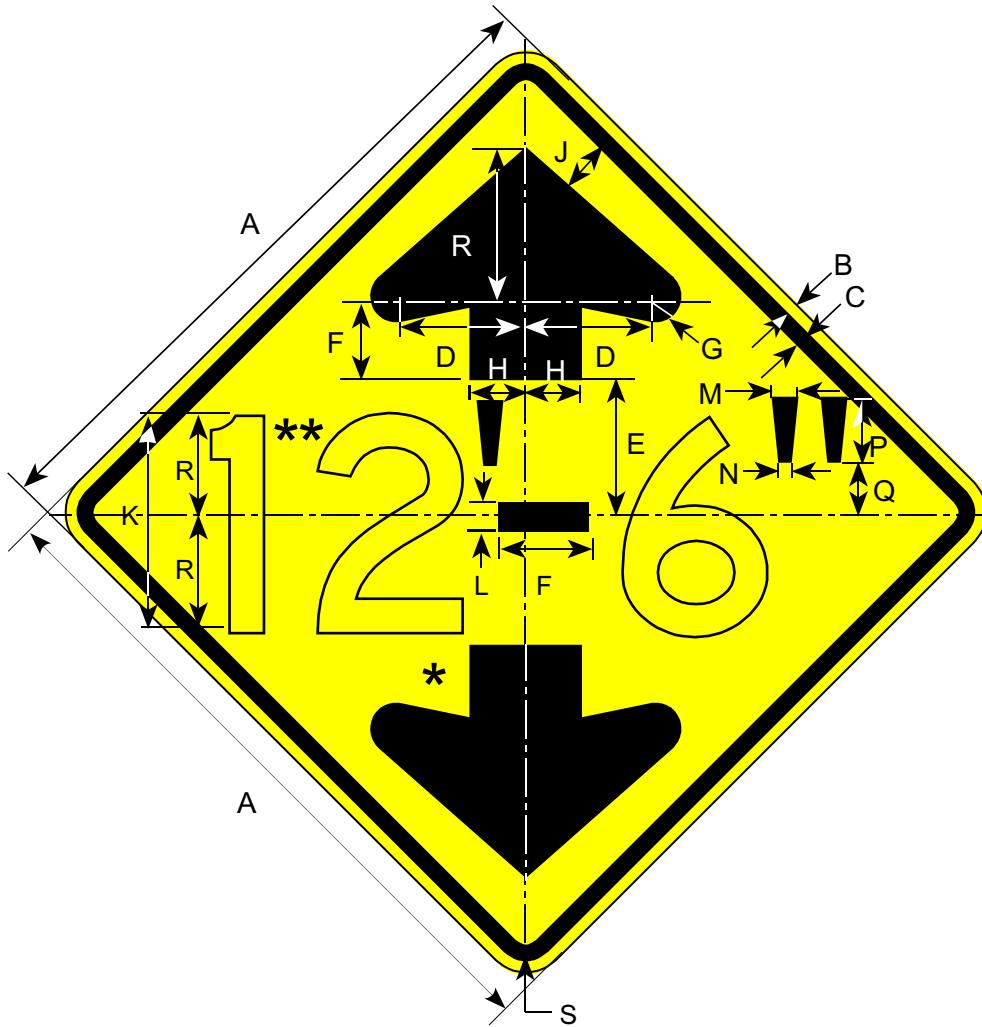

Border and Legend: Black
Background: Yellow

* See Appendix B-1 for Standard Arrow Details.

**If clearance height does not fit on sign
reduce letter series or height as necessary.

Road Class	Dimensions (inches)										
	A	B	C	D	E	F	G	H	J	K	L
Minimum	30	0.50	0.75	5.75	6.63	3.75	0.75	2.5	1.69	10D	1.56
Conventional	36	0.63	0.88	6.88	8.0	4.5	1.06	3.0	2.0	12D	1.88
Expwy/Fwy	48	0.75	1.25	9.19	10.63	5.88	1.3	4.0	2.63	16D	2.44

M	N	P	Q	R	S
1.0	0.44	2.25	3.31	5.0	1.88
1.25	0.50	2.75	4.0	6.0	2.25
1.63	0.63	3.63	5.5	8.0	3.0

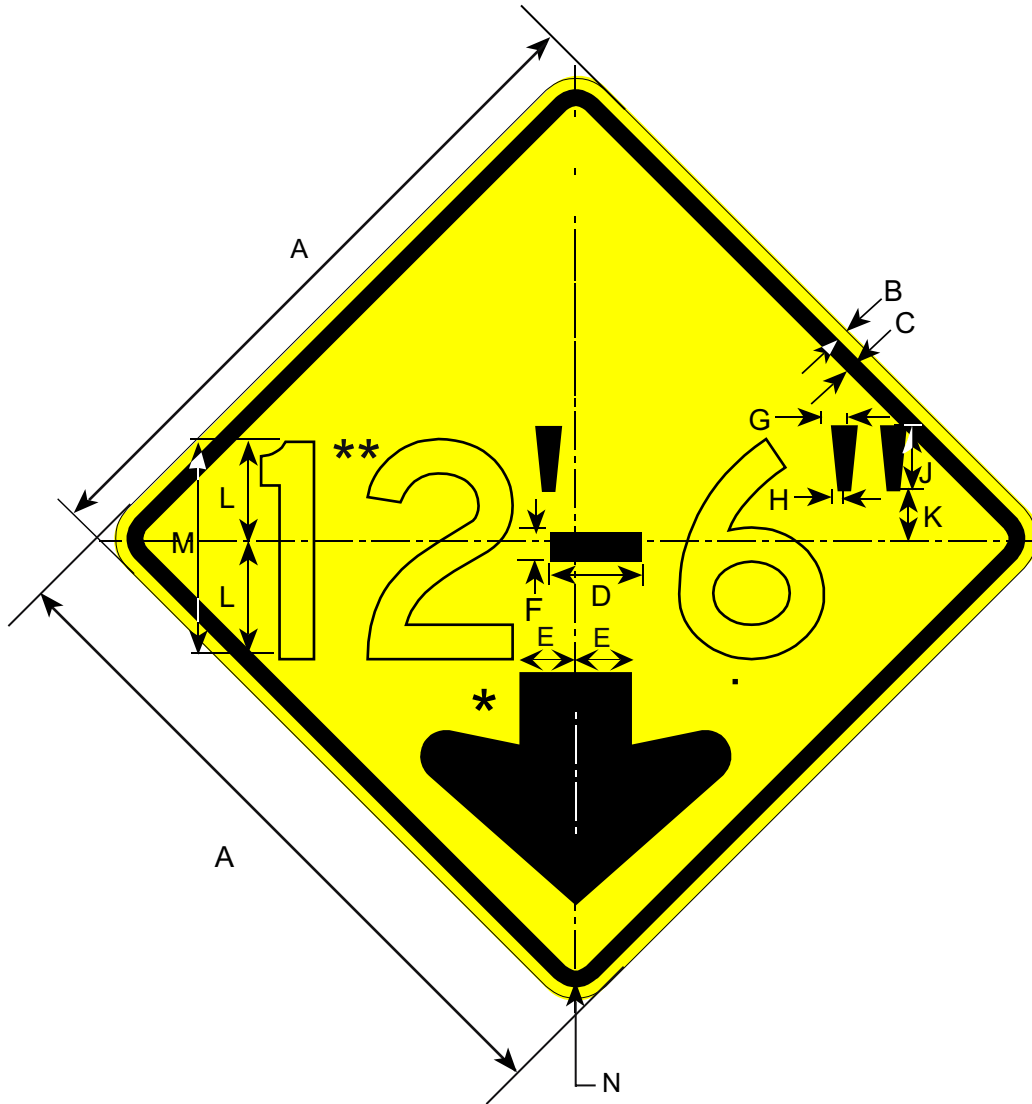

Border and Legend: Black
Background: Yellow

* See Appendix B-1 for Standard Arrow Details.

**If clearance height does not fit on sign
reduce letter series or height as necessary.

Road Class	Dimensions (inches)												
	A	B	C	D	E	F	G	H	J	K	L	M	N
Minimum	30	0.50	0.75	4.13	2.5	1.56	1.0	0.44	2.25	3.31	5.0	10D	1.88
Conventional	36	0.63	0.88	5.0	3.0	1.88	1.25	0.50	2.75	4.0	6.0	12D	2.25
Expwy/Fwy	48	0.75	1.25	6.56	4.0	2.44	1.63	0.63	3.63	5.5	8.0	16D	3.0

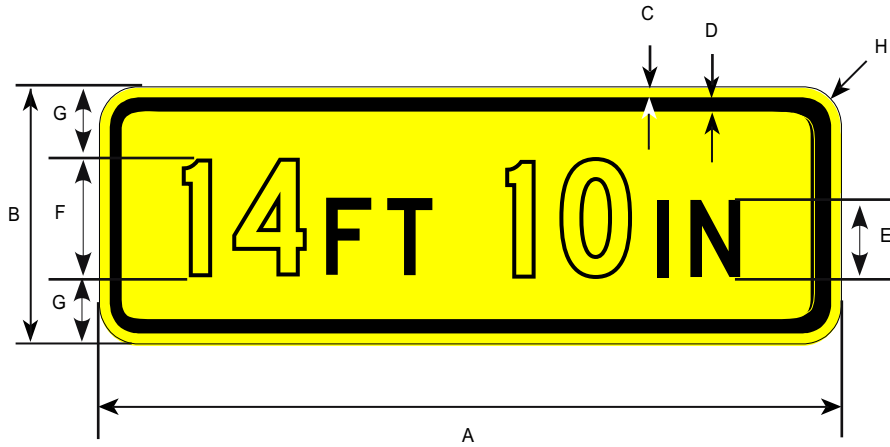

Border and Legend: Black
Background: Yellow

Prior to the 2002 publication of this manual, this sign was numbered CW12-2C.

Road Class	Dimensions (inches)							
	A	B	C	D	E	F	G	H
Minimum	54	18	0.50	0.75	6D	8D	5.0	3.0
Conventional	78	24	0.63	0.88	8D	12D	6.0	3.0
Expwy/Fwy	108	36	0.75	1.25	12D	16D	10	3.0

W12-100



Border and Legend: Black
Background: Yellow

* Reduce spacing by 14%.

Prior to the 2002 publication of this manual, this sign was numbered W12-2B.

Road Class	Dimensions (inches)							
	A	B	C	D	E	F	G	J
Conventional	24	18	0.38	0.63	5D	2	3	1.5

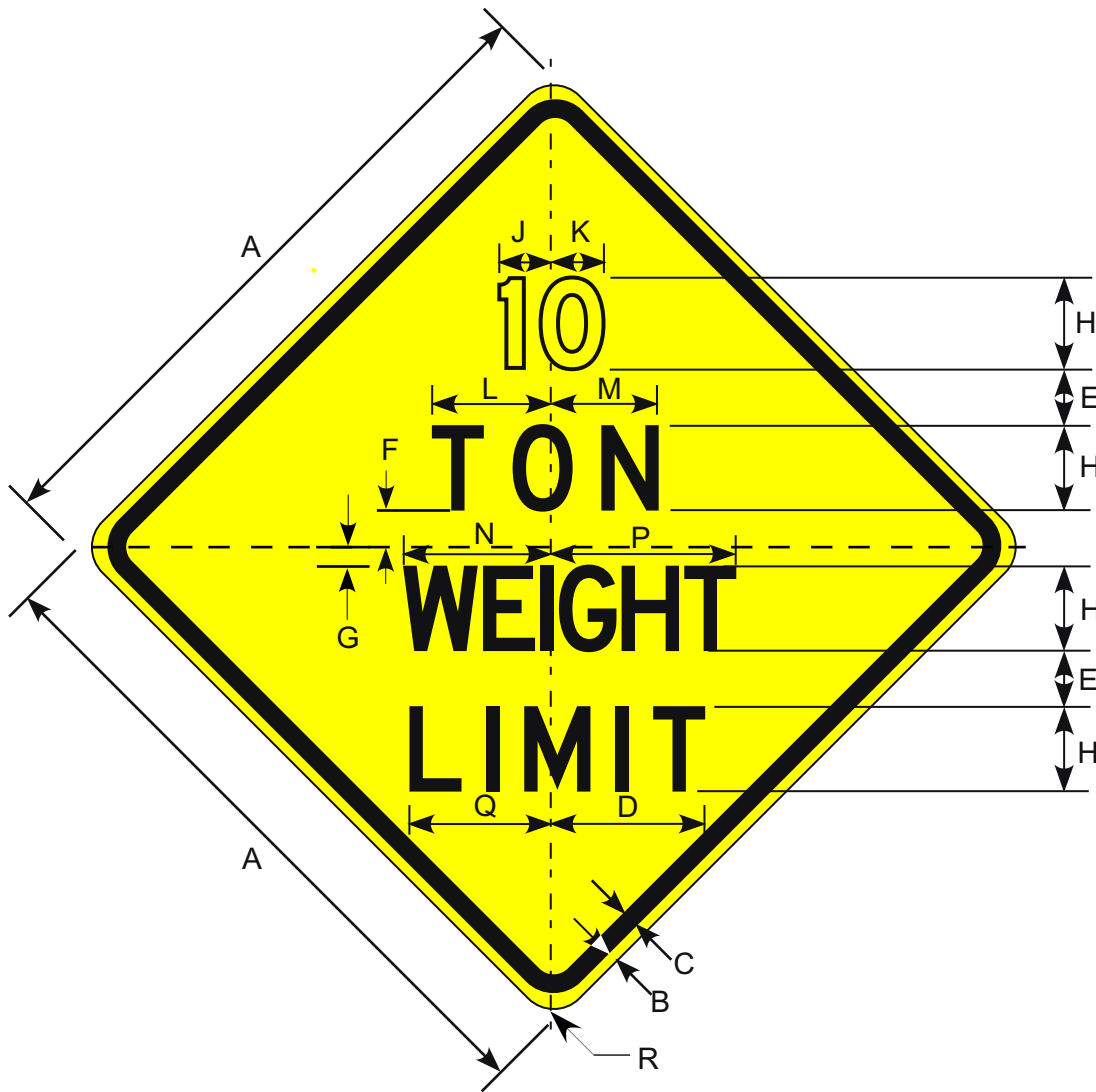

Prior to the 2002 publication of this manual, this sign was numbered W12-4.

Border and Legend: Black
Background: Yellow

Road Class	Dimensions (inches)																
	A	B	C	D	E	F	G	H	J	K	L	M	N	P	Q	R	
Minimum	30	0.50	0.75	7.13	2.5	1.63	0.88	4D	2.38	2.5	5.44	5.0	6.75	8.56	6.5	1.88	
Conventional	36	0.63	0.88	8.25	3.0	2.0	1.0	5D	2.75	2.88	6.25	5.75	7.75	9.88	7.5	2.25	
Expwy/Fwy	48	0.75	1.25	11	4.0	2.63	1.38	6D	3.63	3.88	8.38	7.63	10.38	13.25	10	3.0	

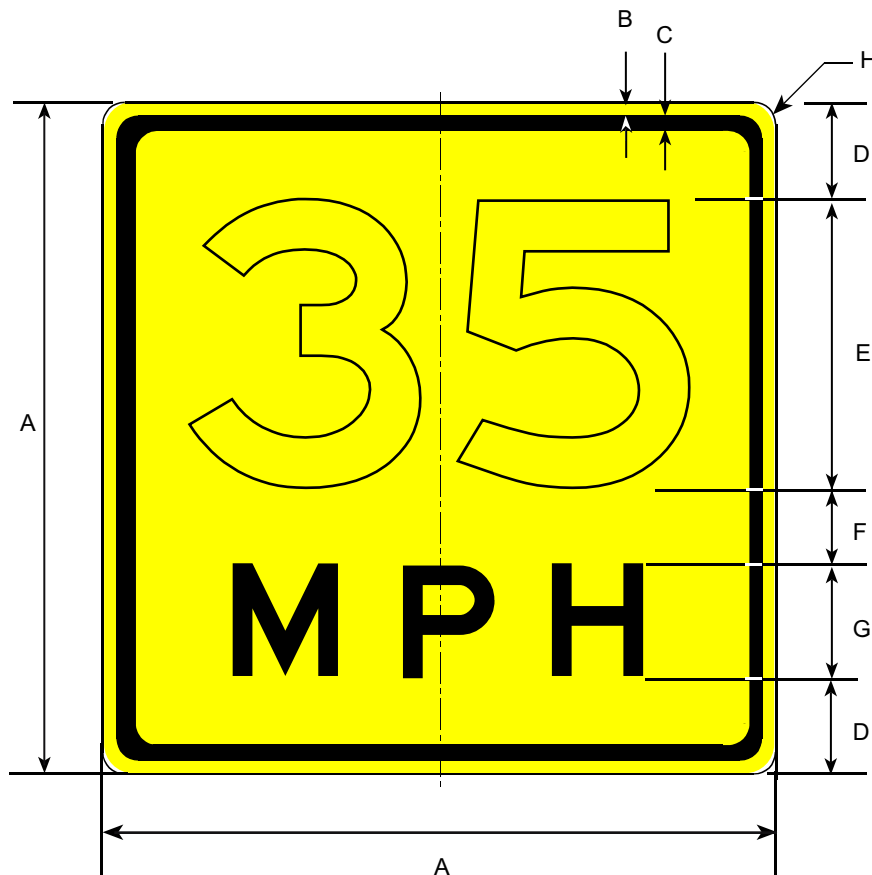

Border and Legend: Black
Background: Yellow

Road Class	Dimensions (inches)							
	A	B	C	D	E	F	G	H
Minimum	18	0.38	0.63	2.5	8E	2.00	3E	1.1
Conventional	24	0.38	0.63	3.6	10E	2.75	4E	1.5
Expwy/Fwy	36	0.50	0.75	4.5	12E	4.00	5E	2.3

W13-1A

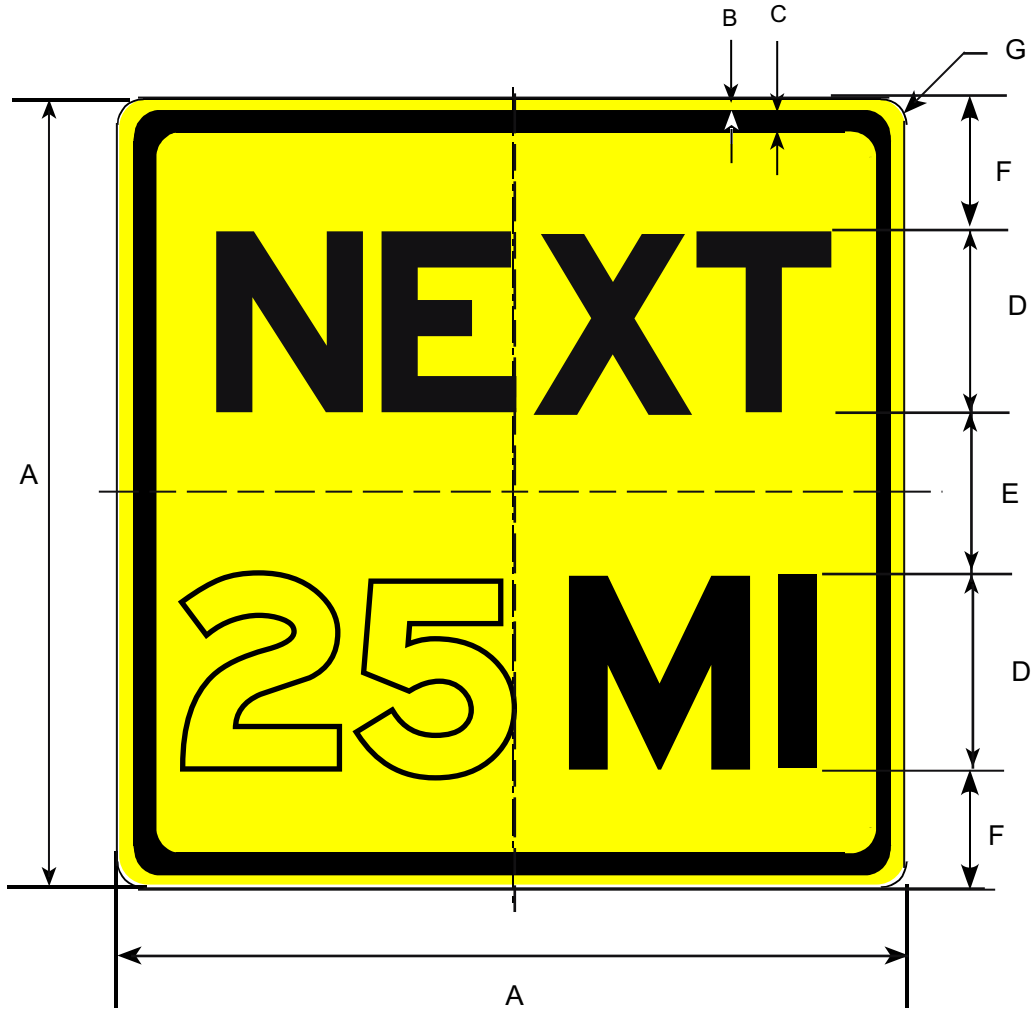

Border and Legend: Black
Background: Yellow

Road Class	Dimensions (inches)						
	A	B	C	D	E	F	G
Conventional	18	0.38	0.50	4D	3.0	3.5	1.5

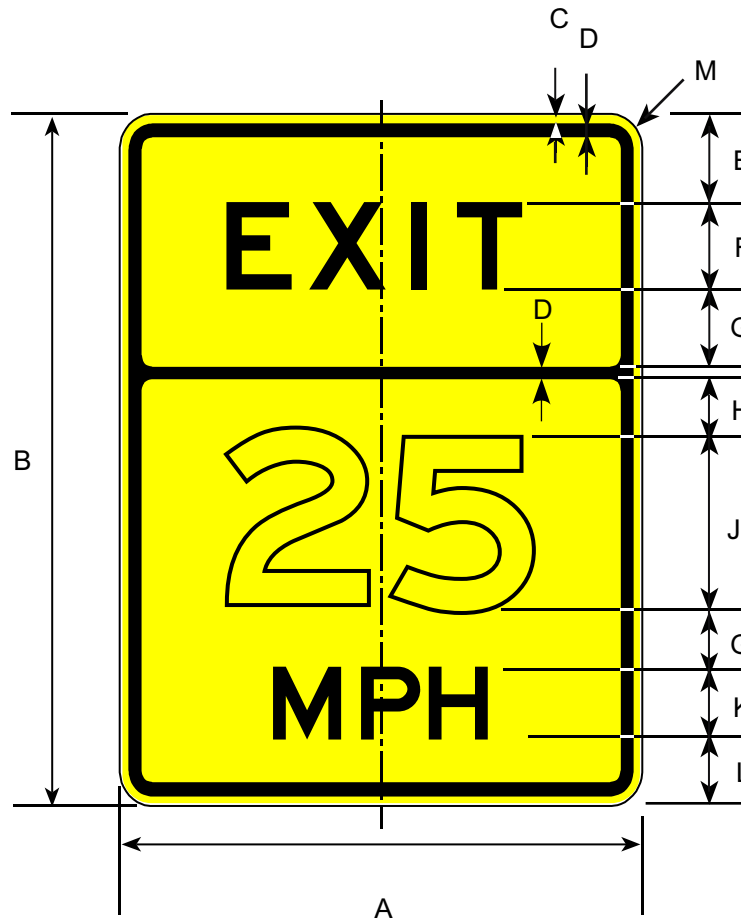

Border and Legend: Black
Background: Yellow

Road Class	Dimensions (inches)											
	A	B	C	D	E	F	G	H	J	K	L	M
Conventional	36	48	0.63	0.88	6	6E	4	5.13	12E	4E	6	2.5
Expwy/Fwy	48	60	0.75	1.25	7	8E	5	5.75	16E	6E	6	3.0

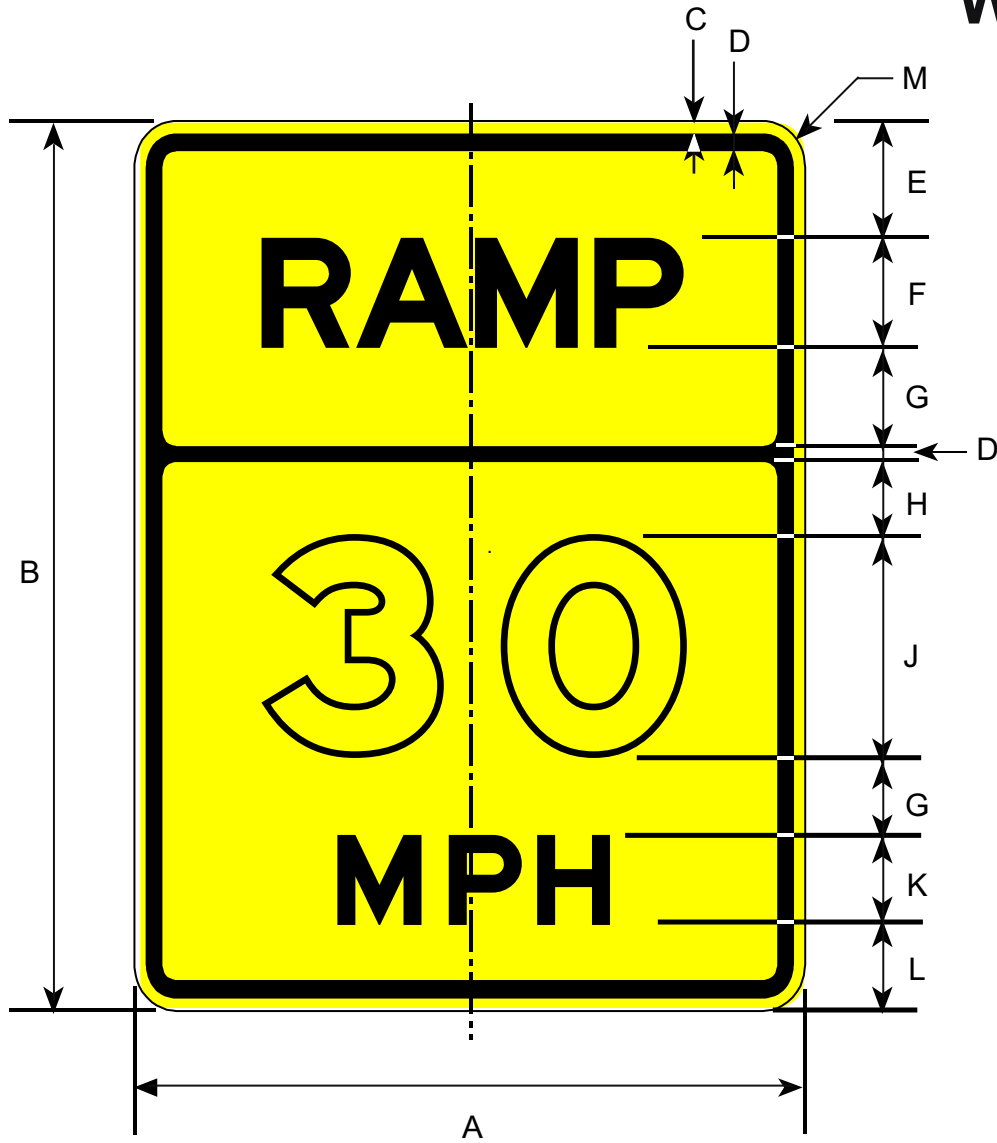

Border and Legend: Black
Background: Yellow

Road Class	Dimensions (inches)											
	A	B	C	D	E	F	G	H	J	K	L	M
Conventional	36	48	0.63	0.88	6	6E	4	5.13	12E	4E	6	2.5
Expwy/Fwy	48	60	0.75	1.25	7	8E	5	5.75	16E	6E	6	3.0

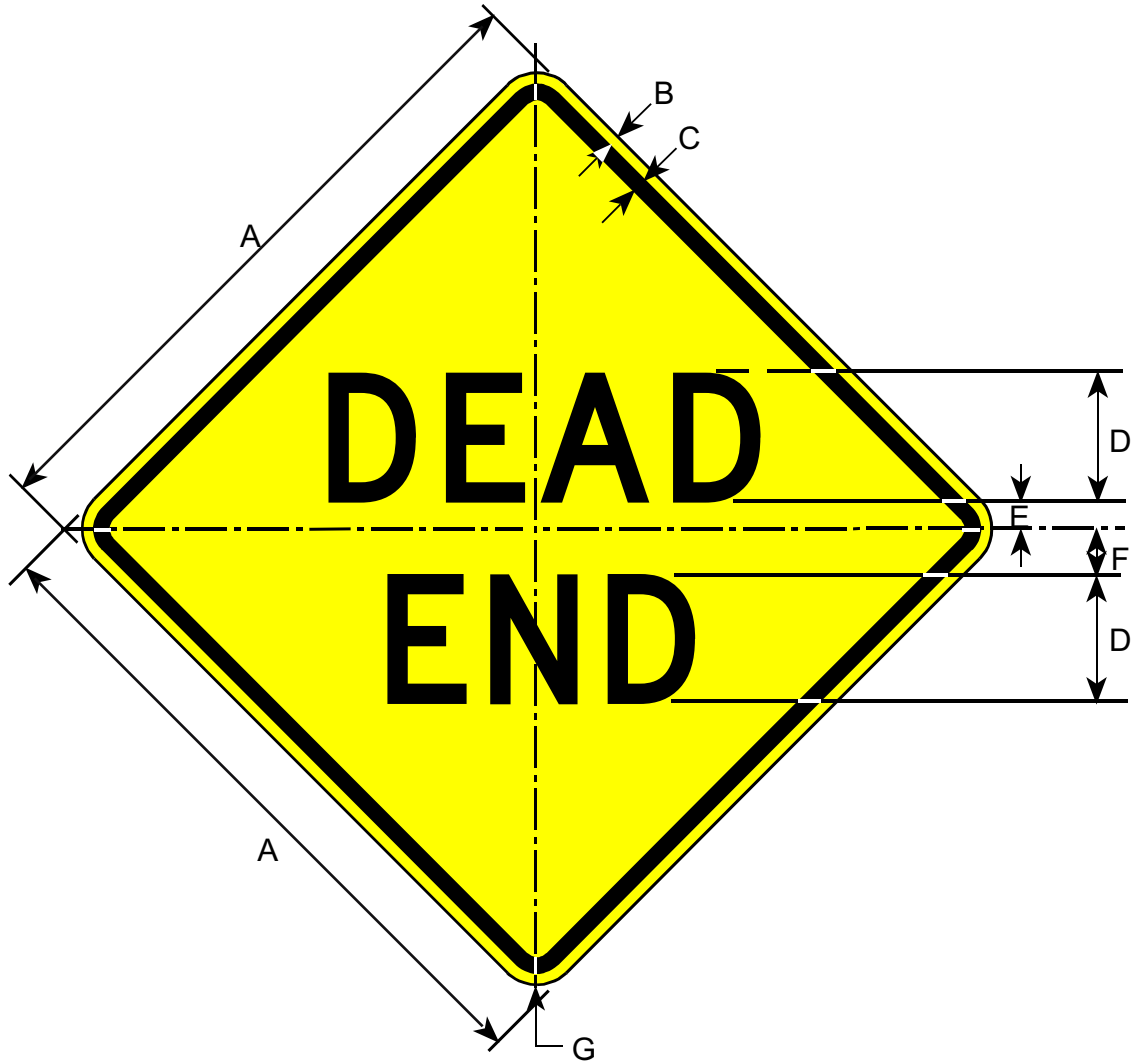

Border and Legend: Black
Background: Yellow

Road Class	Dimensions (inches)						
	A	B	C	D	E	F	G
Conventional	30	0.50	0.75	6D	1.5	2.5	1.88
Expwy/Fwy	36	0.63	0.88	7D	2.0	3.0	2.25

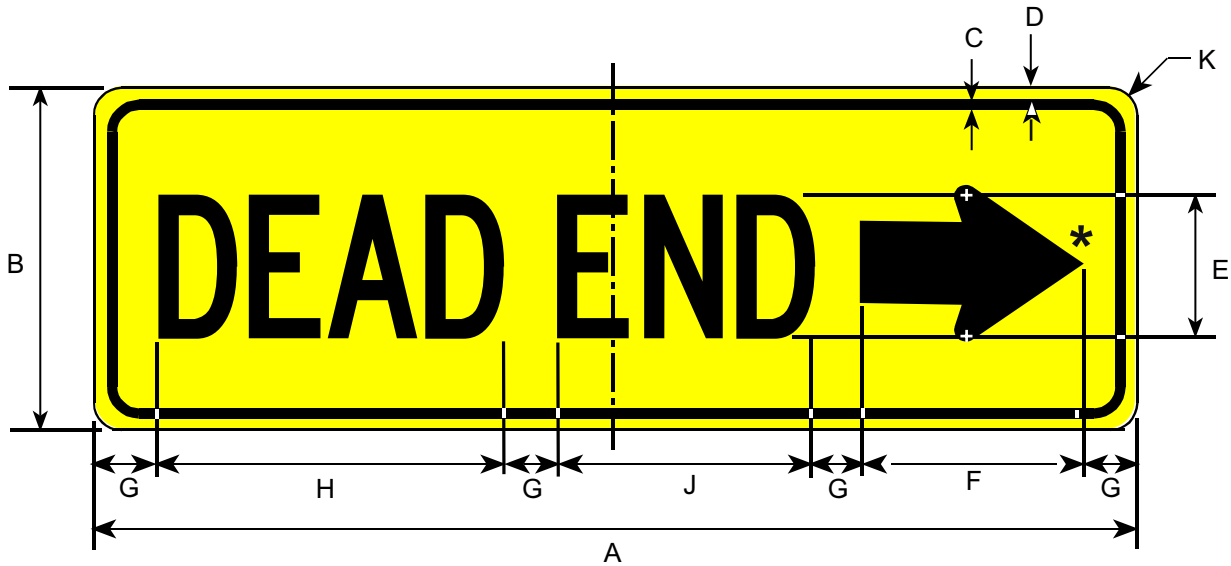

Border and Legend: Black
Background: Yellow

* See Appendix B-1 for Standard Arrow Details.

Road Class	A	B	C	D	E	F	G	H	J	K
Conventional	36	12	0.75	0.50	5C	5.0	2.0	13	10	1.5

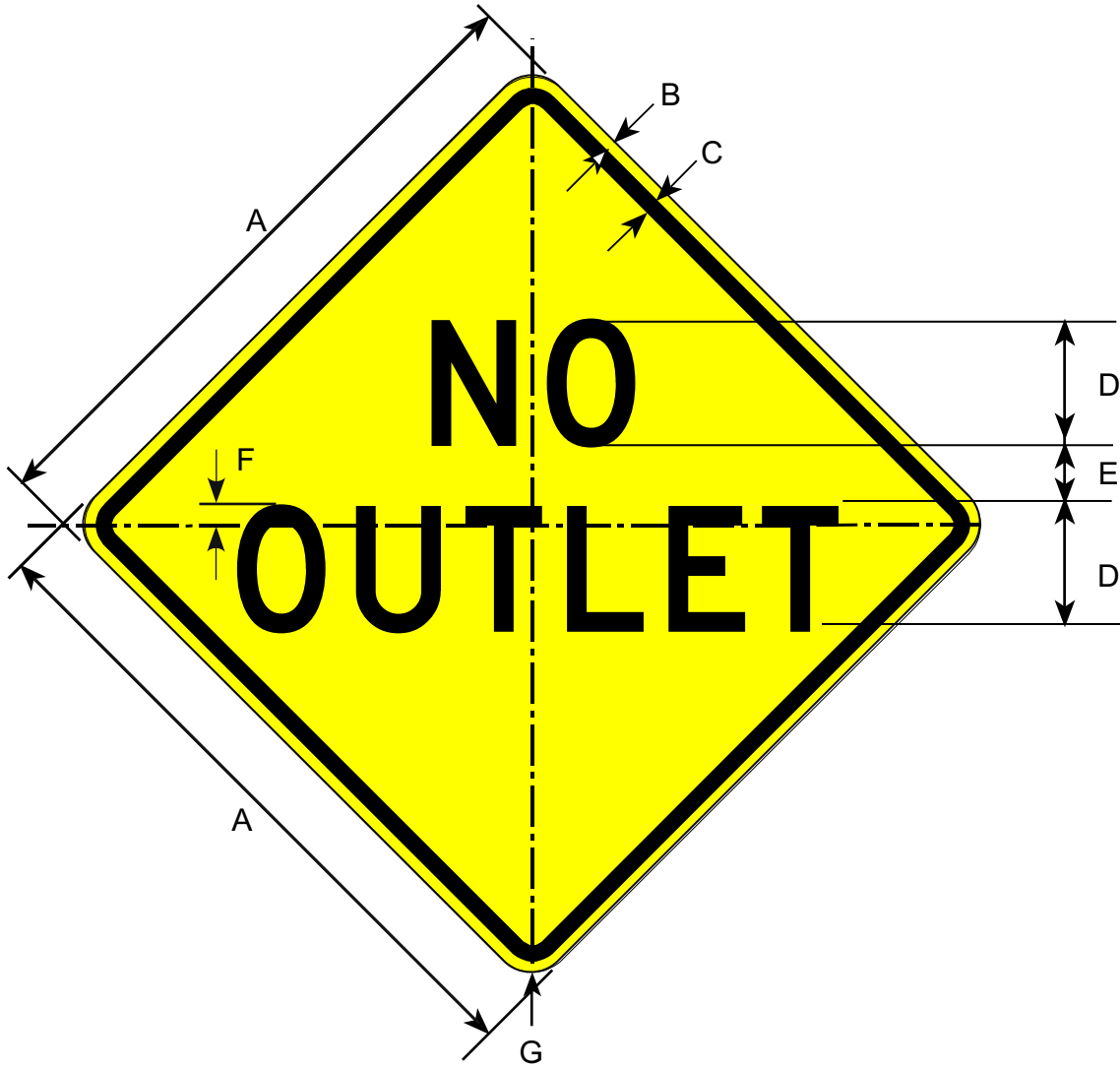

Border and Legend: Black
 Background: Yellow

Road Class	Dimensions (inches)						
	A	B	C	D	E	F	G
Minimum	30	0.50	0.75	6D	1.5	0.94	1.88
Conventional	36	0.63	0.88	7D	2.0	1.13	2.25

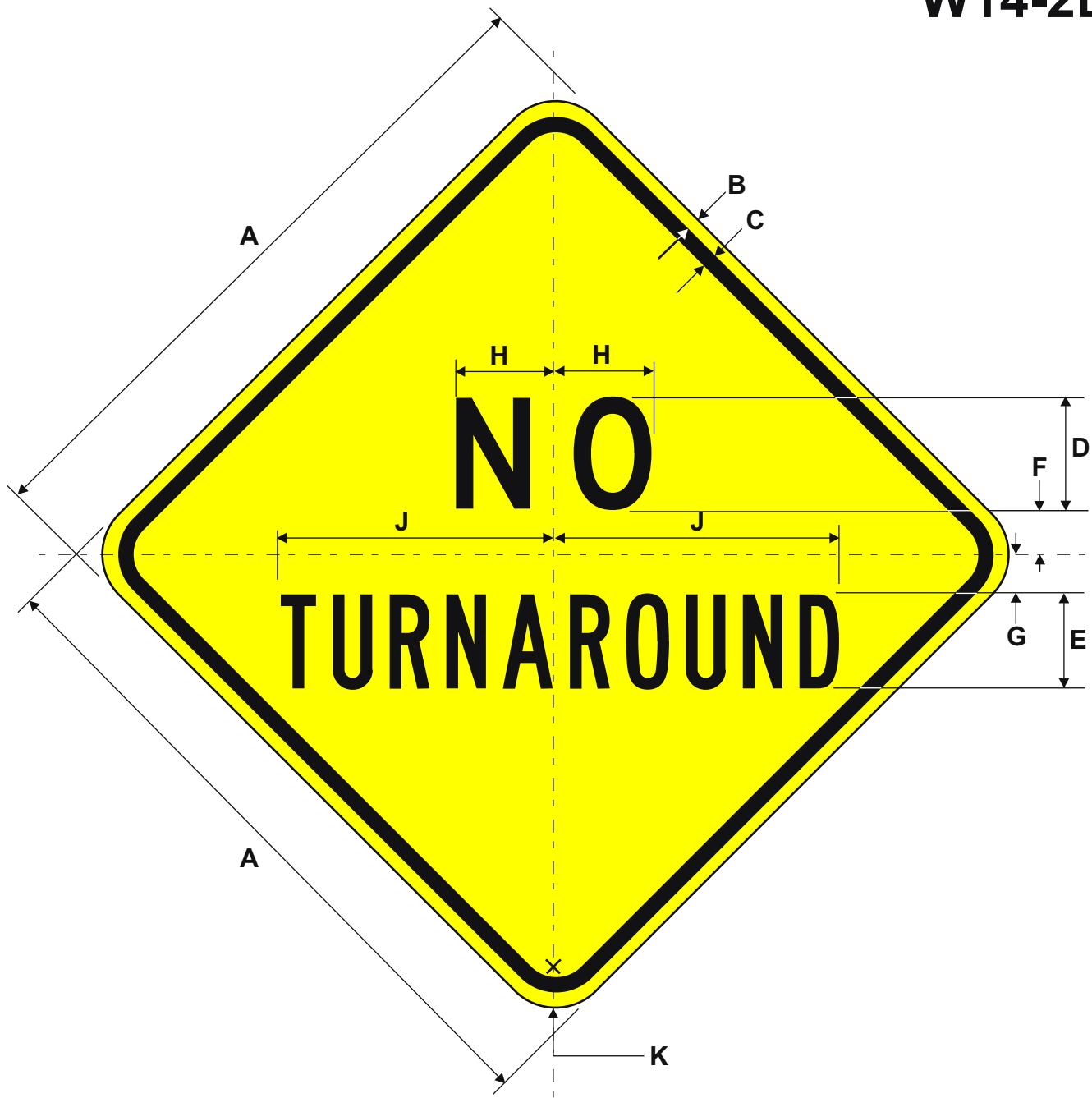

Border and Legend: Black
 Background: Yellow

Road Class	Dimensions (inches)									
	A	B	C	D	E	F	G	H	J	K
Conv/Min	36	0.63	0.88	6D	5B	2.5	2.0	5.19	14.64	2.25

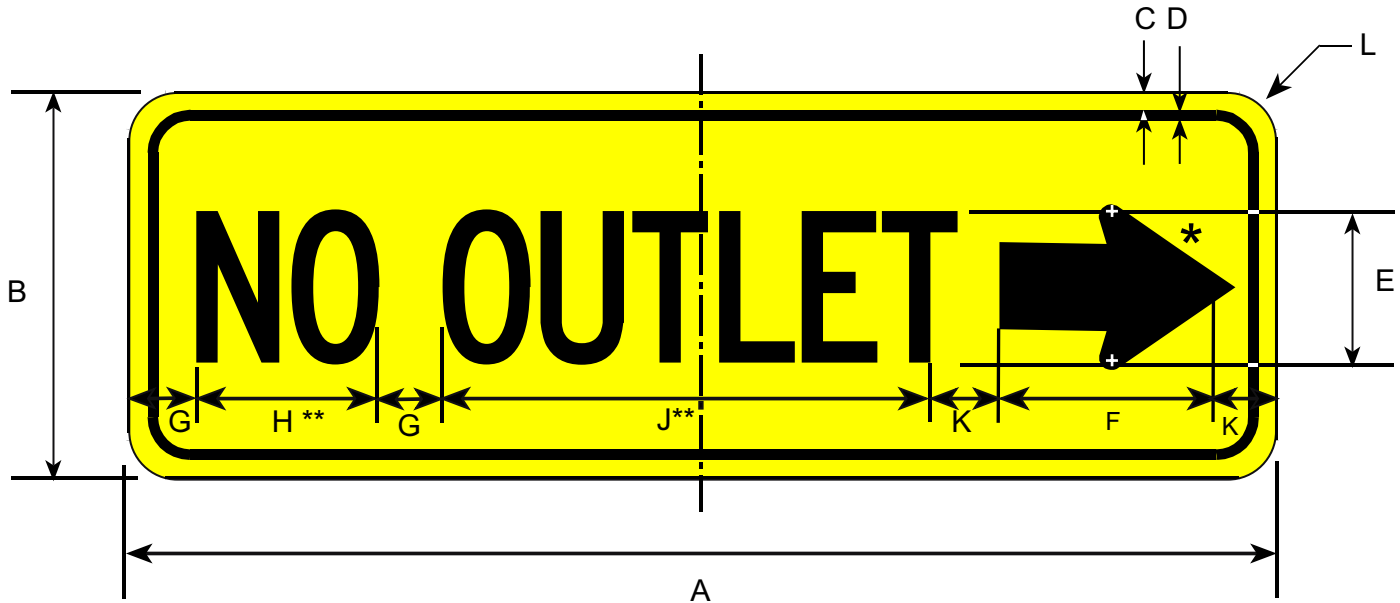

A
W14-2PR



W14-2PL

* See Appendix B-1 for Standard Arrow Details.
 **Spacing has been reduced by 50%

Border and Legend: Black
 Background: Yellow

Road Class	Dimensions (inches)										
	A	B	C	D	E	F	G	H	J	K	L
Conventional	36	12	0.75	0.50	5C	5.0	1.75	6.13	17	2.19	1.5

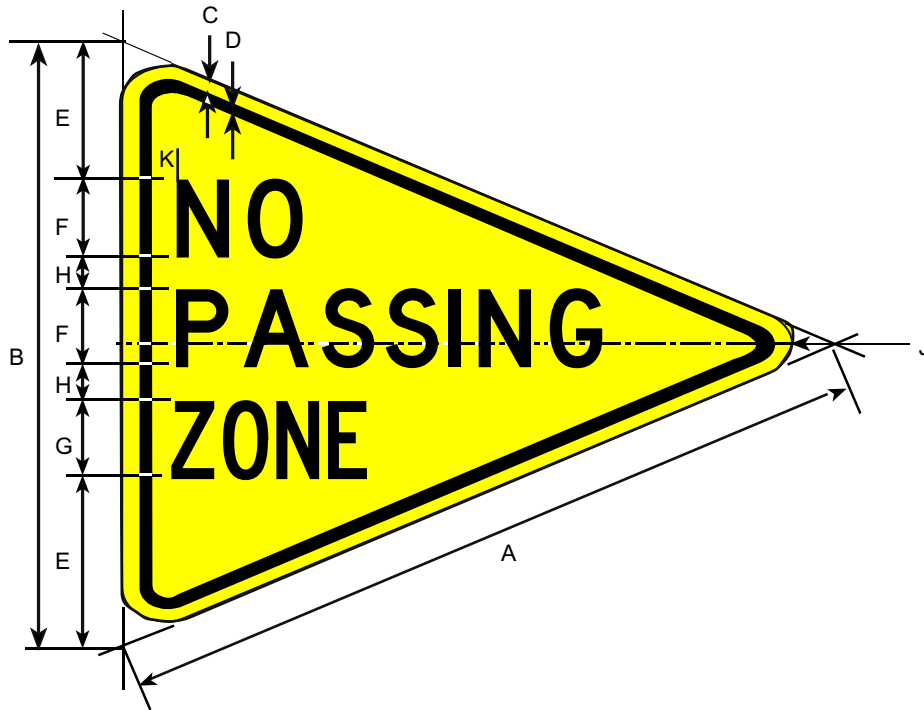

Border and Legend: Black
Background: Yellow

Road Class	Dimensions (inches)									
	A	B	C	D	E	F	G	H	J	K
Minimum	40	30	0.50	0.75	7.25	4D	4C	1.75	1.88	2.5
Conventional	48	36	0.63	0.88	8.50	5D	5C	2.00	2.25	3.0
Oversized	64	48	0.75	1.25	12.00	6D	6C	3.00	3.00	4.0

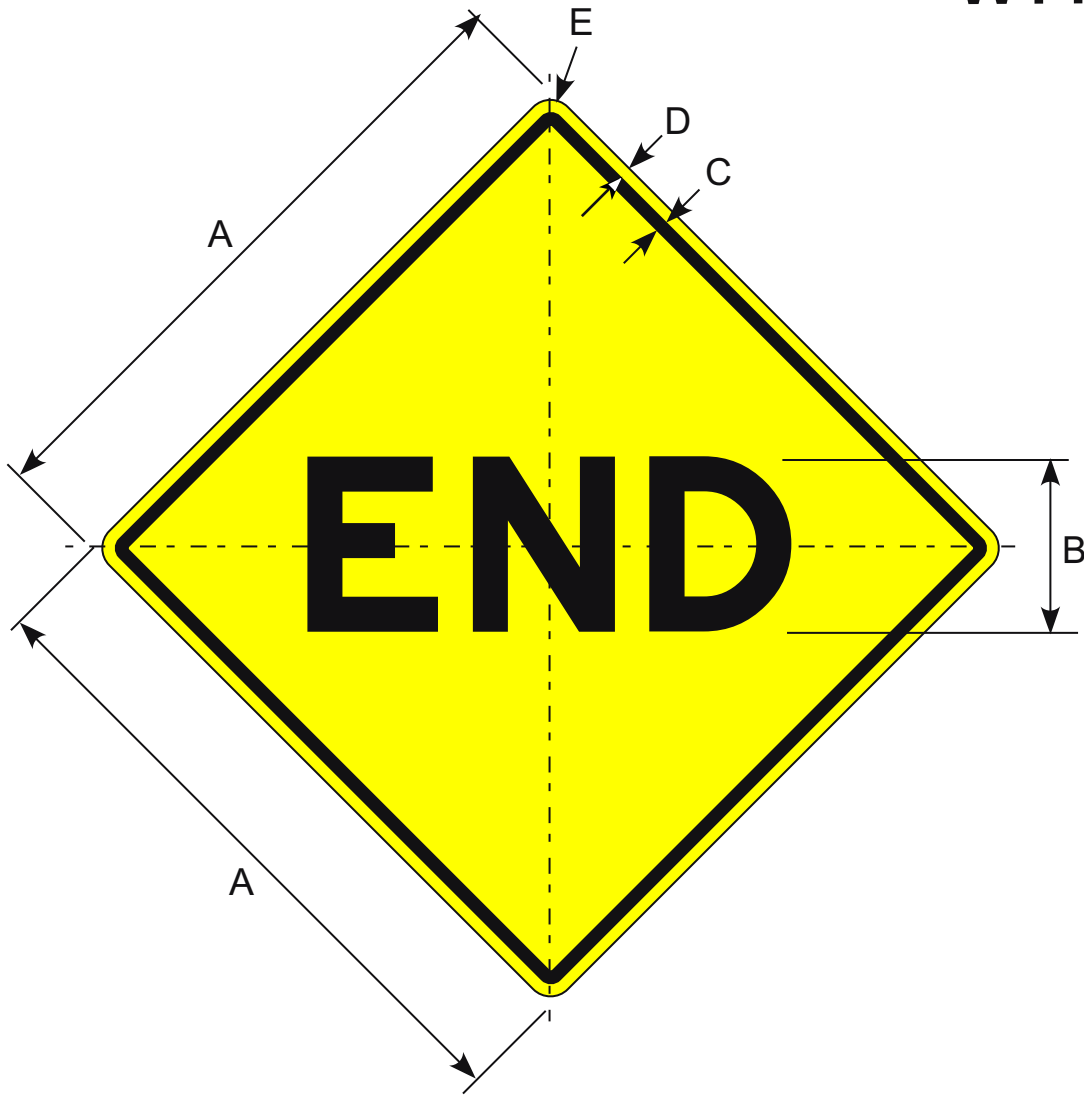

Border and Legend: Black
Background: Yellow

Prior to the 2002 publication of this manual, this sign was numbered W14-2A.

Road Class	Dimensions (inches)				
	A	B	C	D	E
Conventional	30	8E	0.75	0.5	2.25

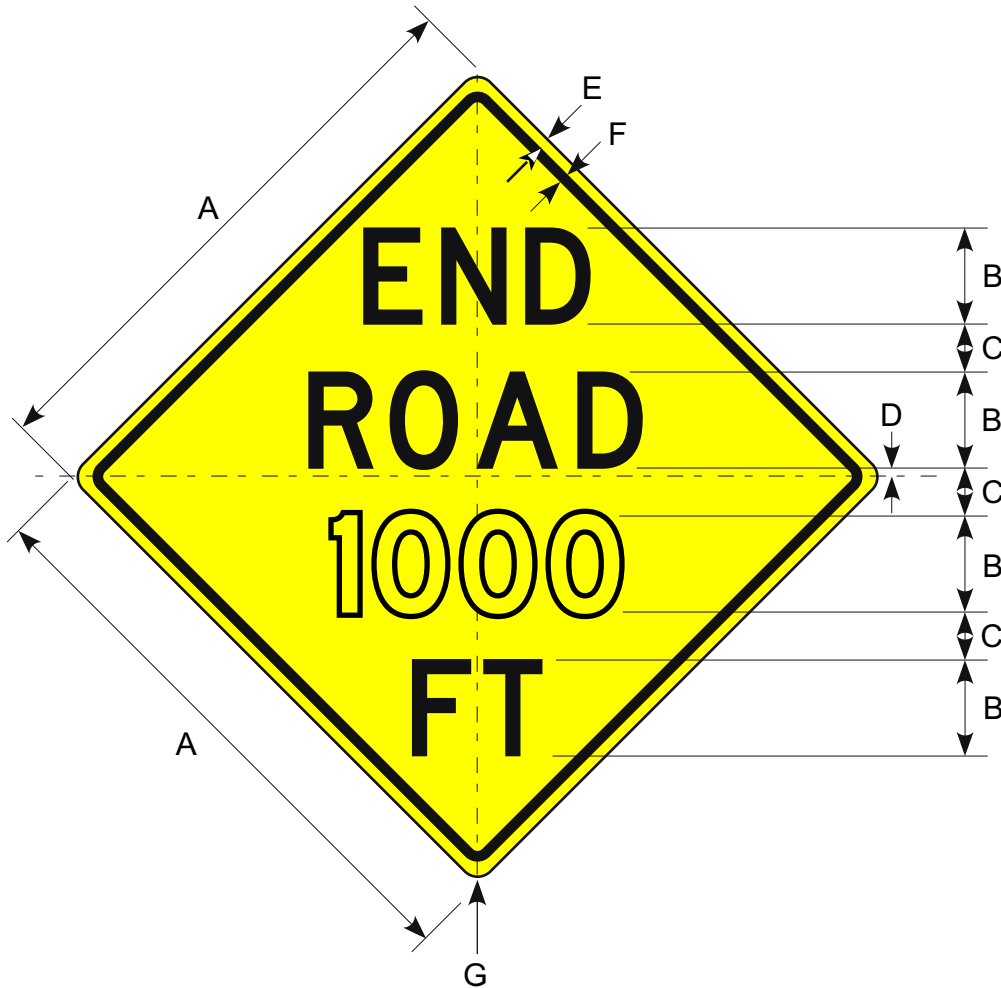

Border and Legend: Black
Background: Yellow

Prior to the 2002 publication of this manual, this sign was numbered W14-2B.

Road Class	Dimensions (inches)						
	A	B	C	D	E	F	G
Minimum	30	5D	2.5	0.38	0.50	0.75	1.88
Conventional	36	6D	3.0	0.50	0.75	1.25	2.25

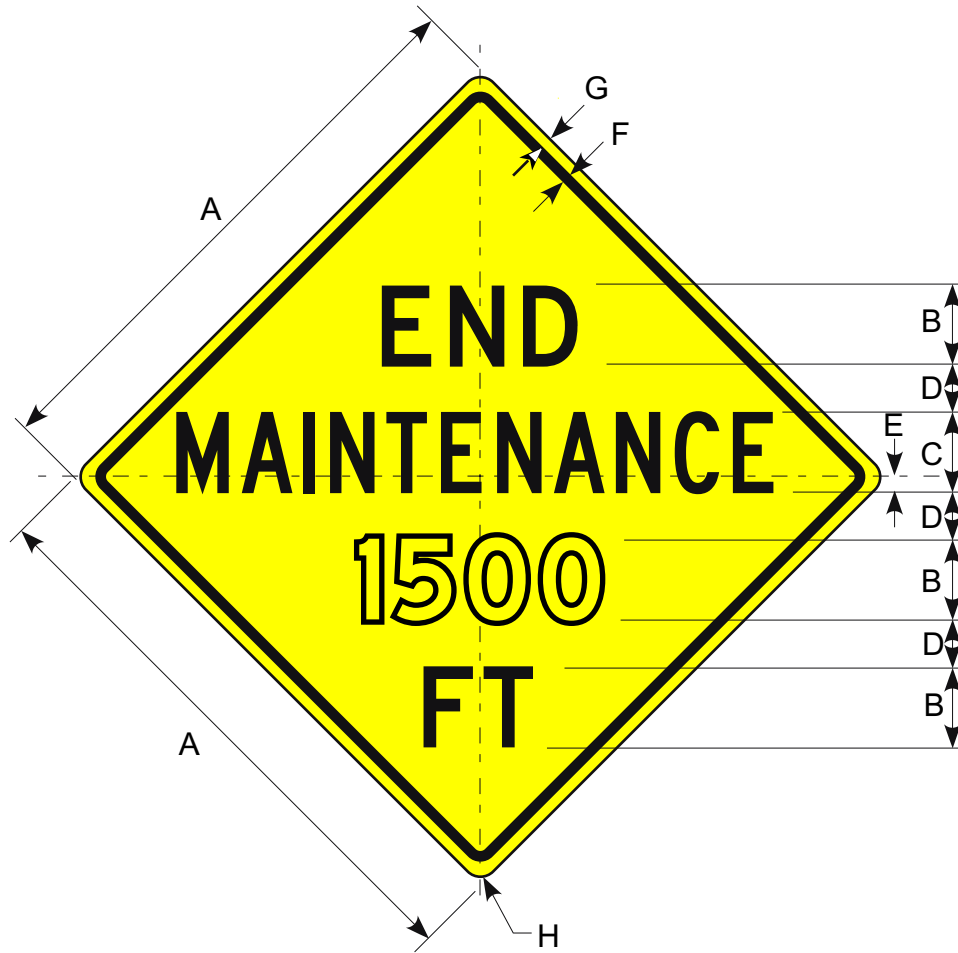

Border and Legend: Black
Background: Yellow

Prior to the 2002 publication of this manual, this sign was numbered W14-2C.

Road Class	Dimensions (inches)							
	A	B	C	D	E	F	G	H
Minimum	30	4D	4C	2.75	0.88	0.75	0.50	1.88
Conventional	36	5D	5C	3.00	1.00	0.88	0.63	2.25

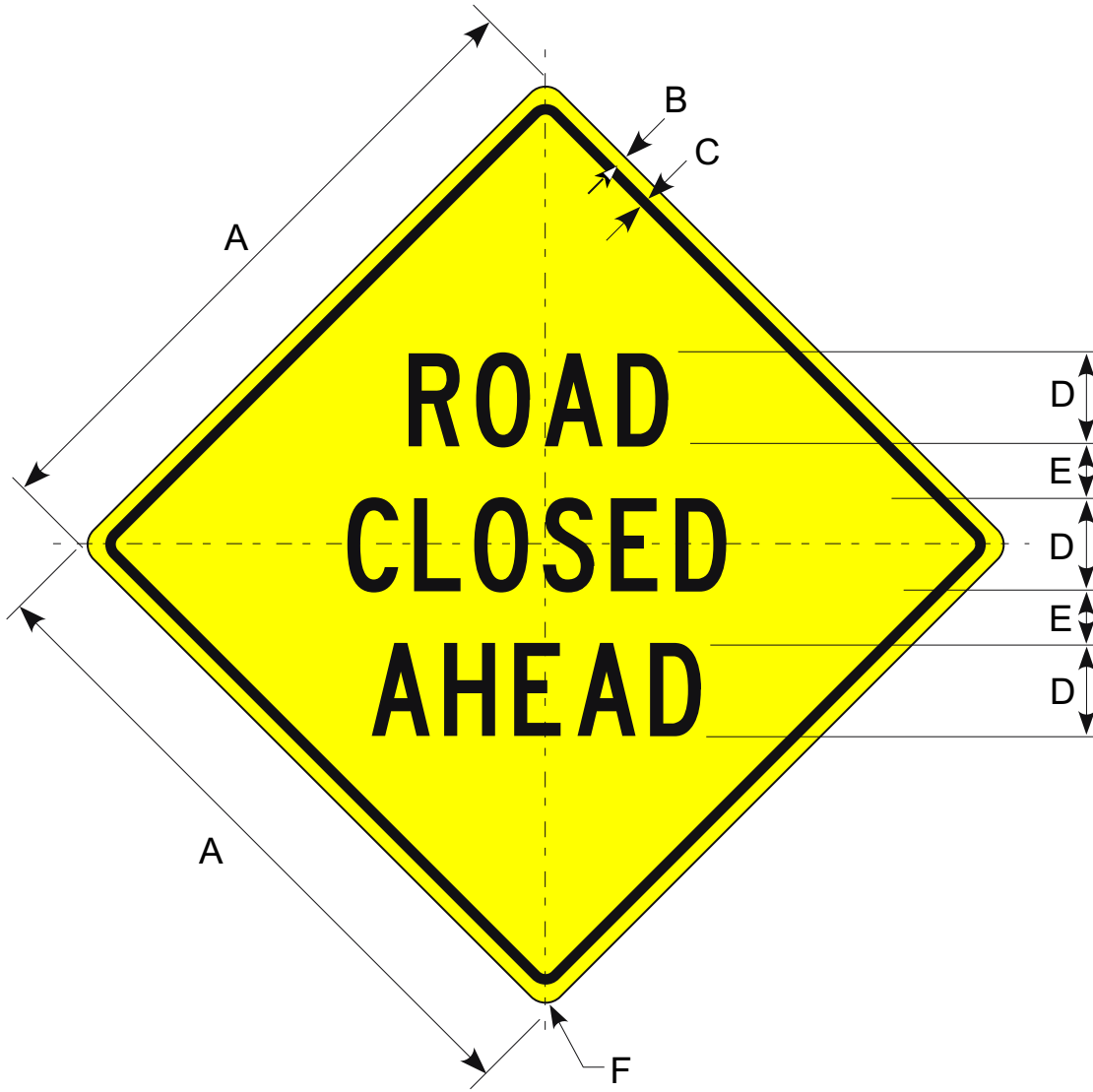

Border and Legend: Black
 Background: Yellow

Prior to the 2002 publication of this manual, this sign was numbered W14-5A.

Road Class	Dimensions (inches)					
	A	B	C	D	E	F
Minimum	30	0.50	0.75	4C	2.63	1.88
Conventional	36	0.63	0.88	5C	3.25	2.25
Expwy/Fwy	48	0.75	1.25	6C	4.00	3.00

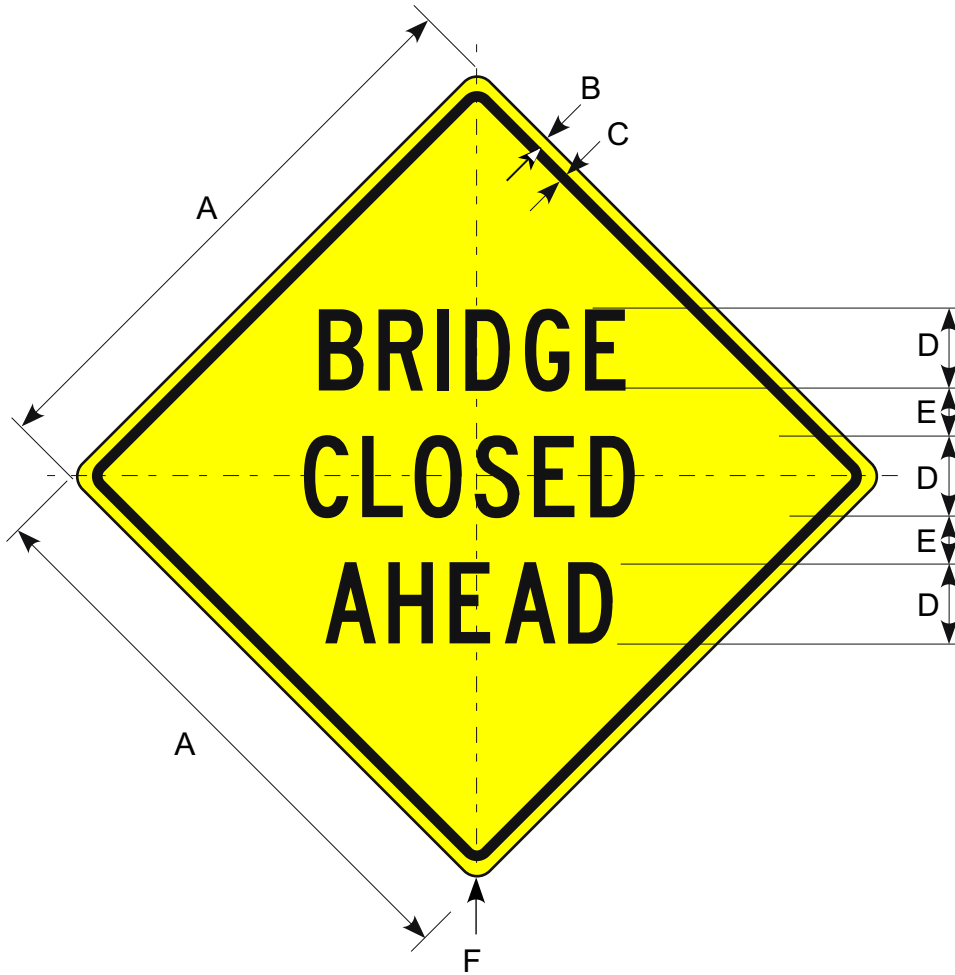

Border and Legend: Black
Background: Yellow

Prior to the 2002 publication of this manual, this sign was numbered W14-5B.

Road Class	Dimensions (inches)					
	A	B	C	D	E	F
Minimum	30	0.50	0.75	4C	2.63	1.88
Conventional	36	0.63	0.88	5C	3.25	2.25
Expwy/Fwy	48	0.75	1.25	6C	4.00	3.00

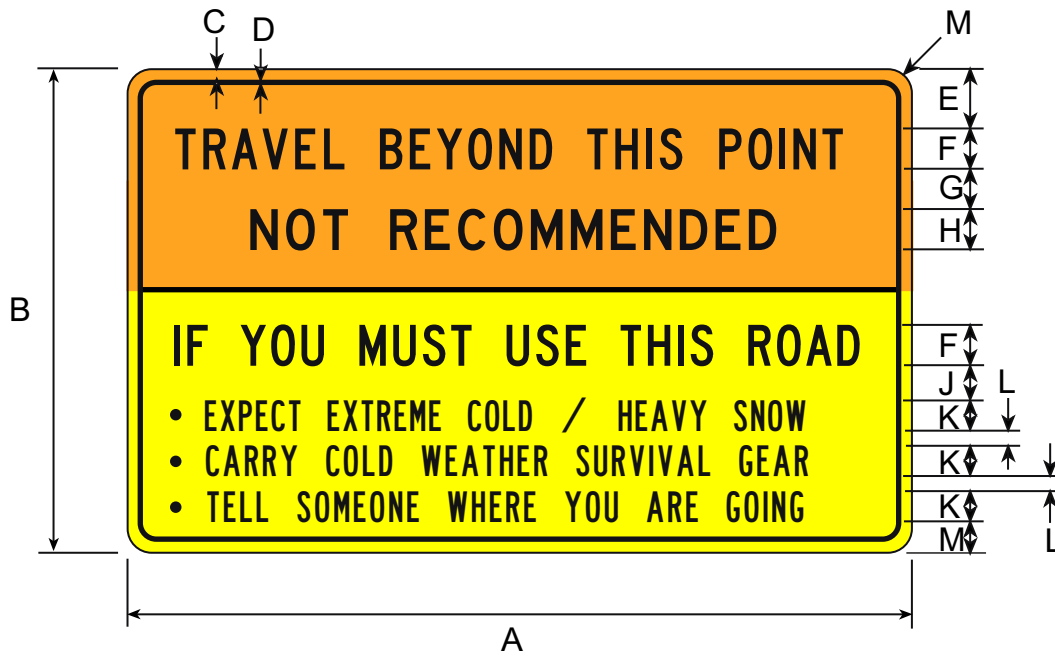

Border and Legend: Black
 Upper Background: Orange
 Lower Background: Yellow

Road Class	Dimensions (inches)											
	A	B	C	D	E	F	G	H	J	K	L	M
Conv & Min	78	48	1.33	1.75	6	4C	4	4D	3.5	3B	1.5	3

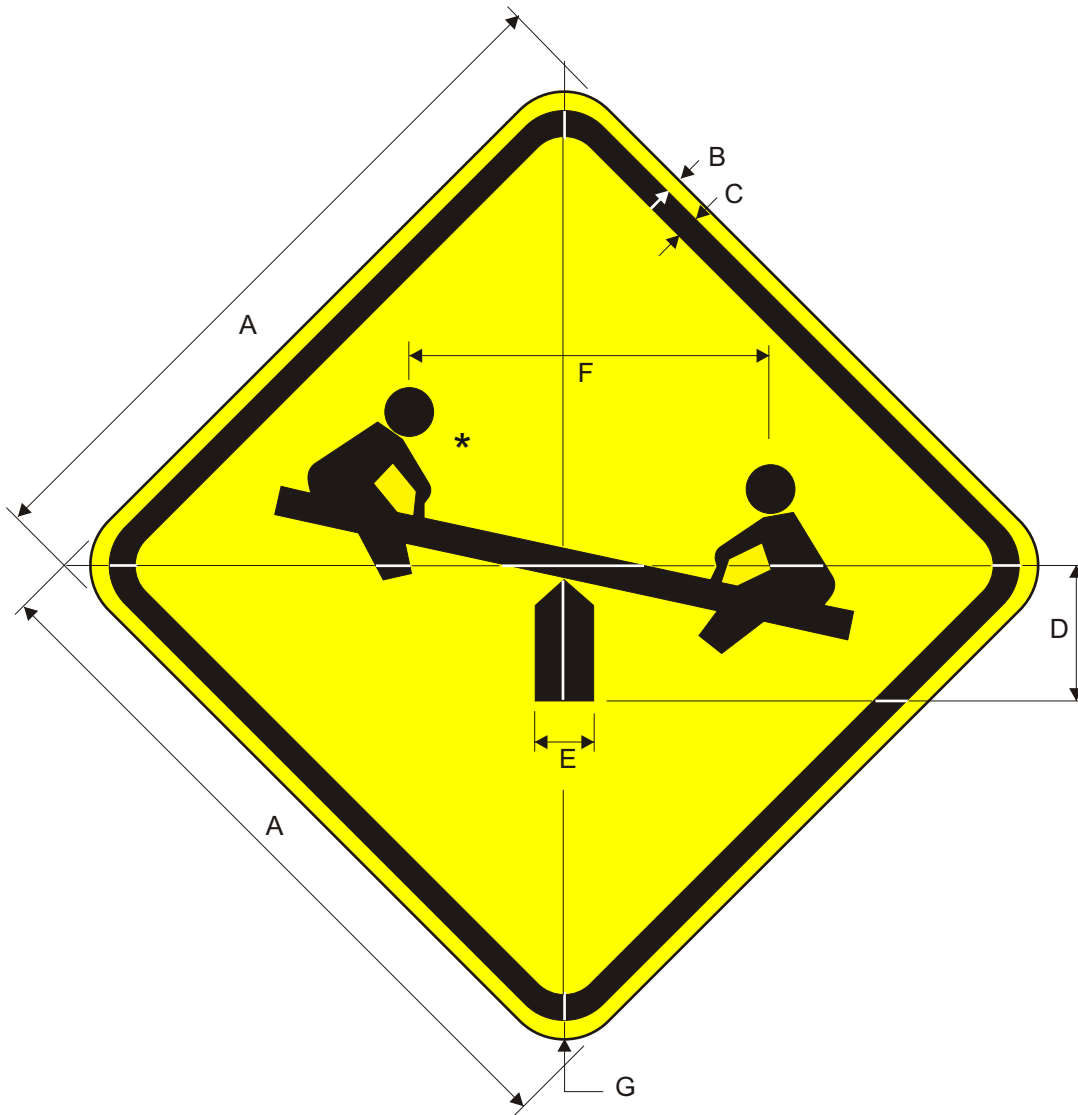

*Make symbol proportional to the graphic shown.

Border and Legend: Black
Background: Yellow

Prior to the 2006 publication of this manual, this sign was numbered W11-106.

Road Class	Dimensions (inches)						
	A	B	C	D	E	F	G
Min.	24	0.38	0.63	4.6	2.0	12.4	1.5
Conv.	30	0.50	0.75	5.75	2.5	15.5	1.88
Oversized	36	0.63	0.88	7.0	3.0	18.63	2.25

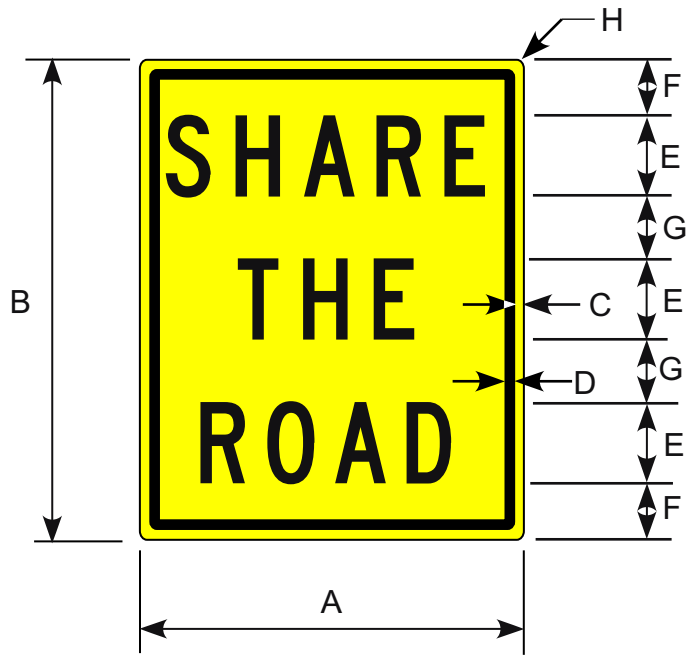

Border and Legend: Black
 Background: Yellow

Road Class	Dimensions (inches)							
	A	B	C	D	E	F	G	H
Minimum	18	24	0.38	0.63	4C	2.0	4.0	1.13
Conventional	24	30	0.38	0.63	5C	3.5	4.0	1.5

W16-2P

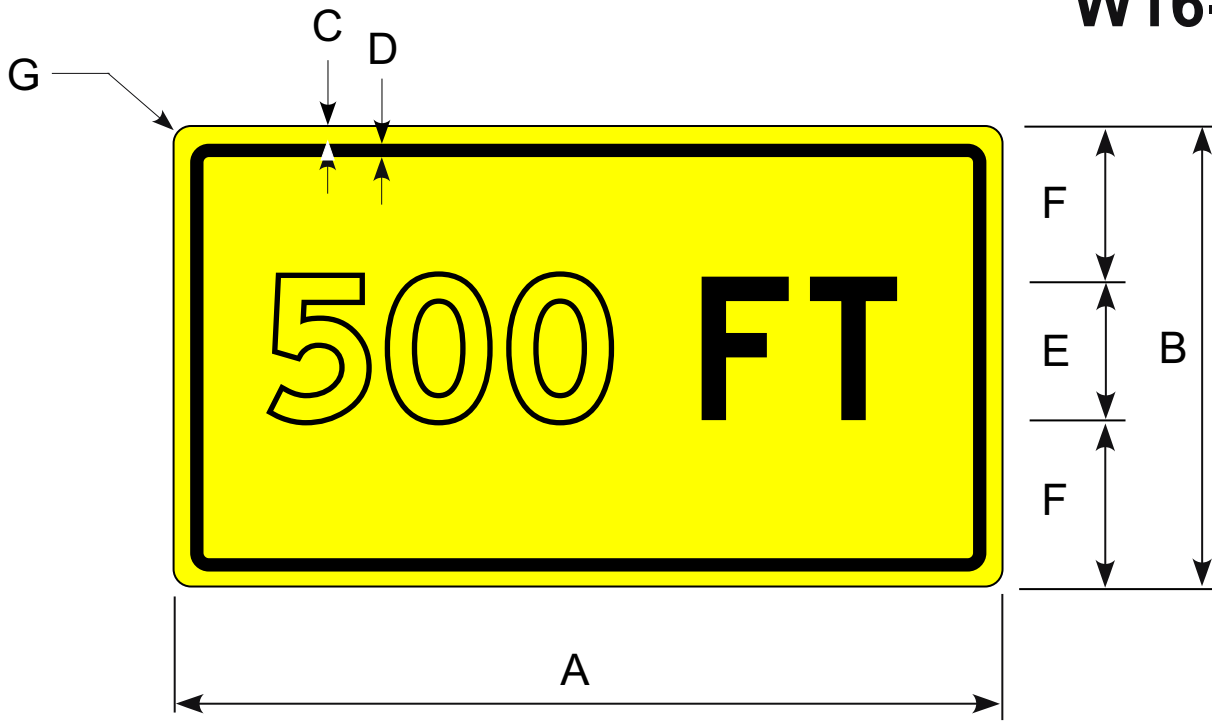

Border and Legend: Black
Background: Yellow or Orange

Road Class	Dimensions (inches)						
	A	B	C	D	E	F	G
Minimum	24	12	0.50	0.50	4D	10	1.88
Conventional	36	20	0.63	0.88	6D	15	2.25
Expwy/Fwy	48	30	0.75	1.25	8D	20	3.00

W16-3
W16-3A
W16-4

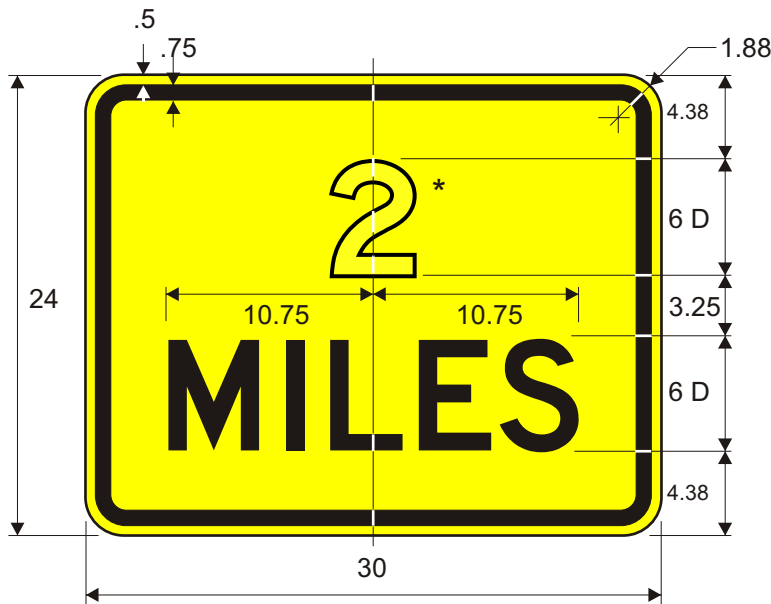

W16-3

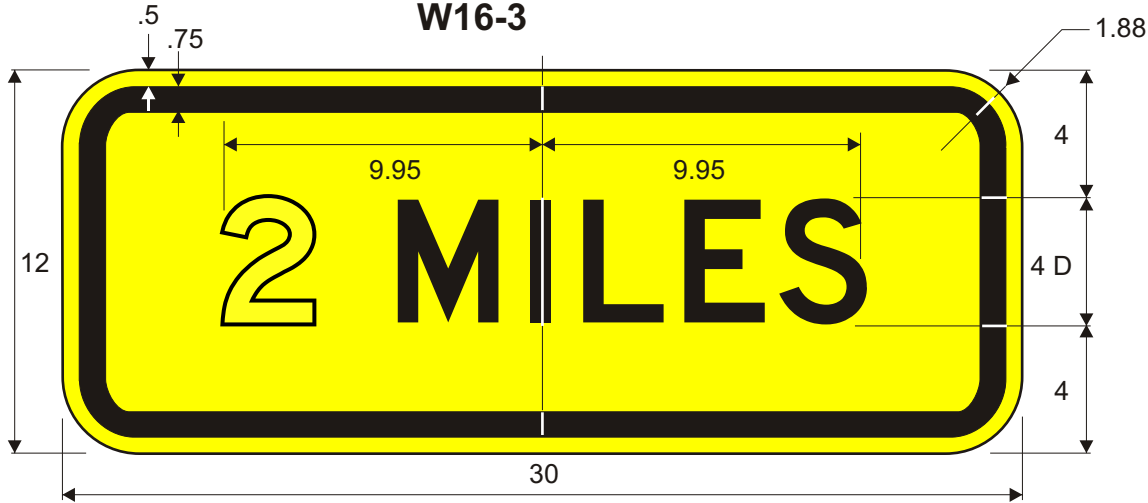

W16-3a

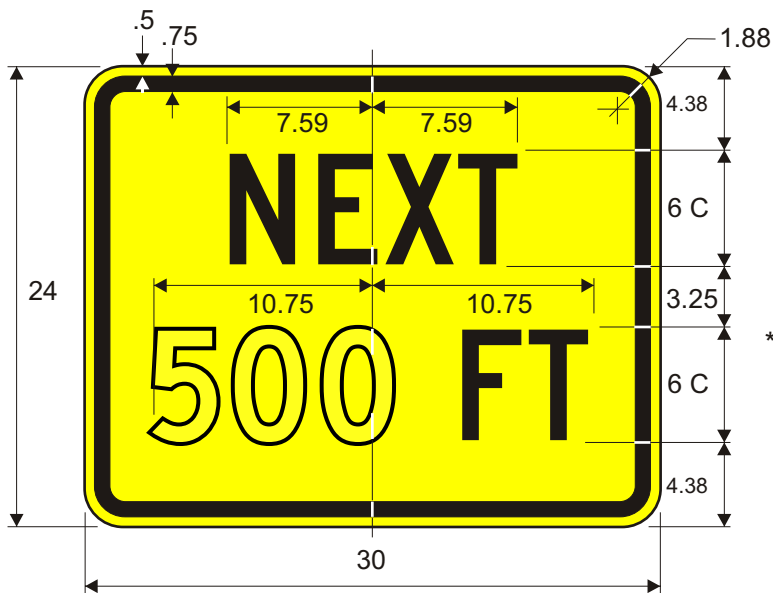

W16-4

*Optically locate numerals about centerline.

Border and Legend: Black
 Background: Yellow

W16-5P
W16-6P

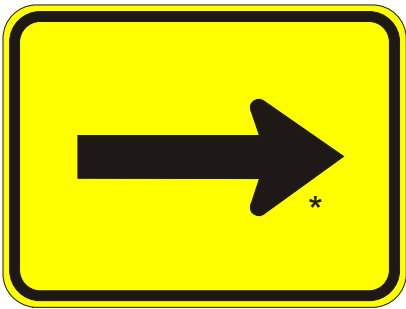

W16-5pR

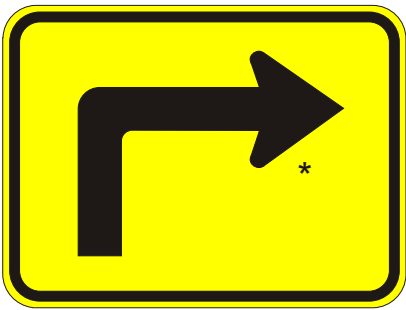
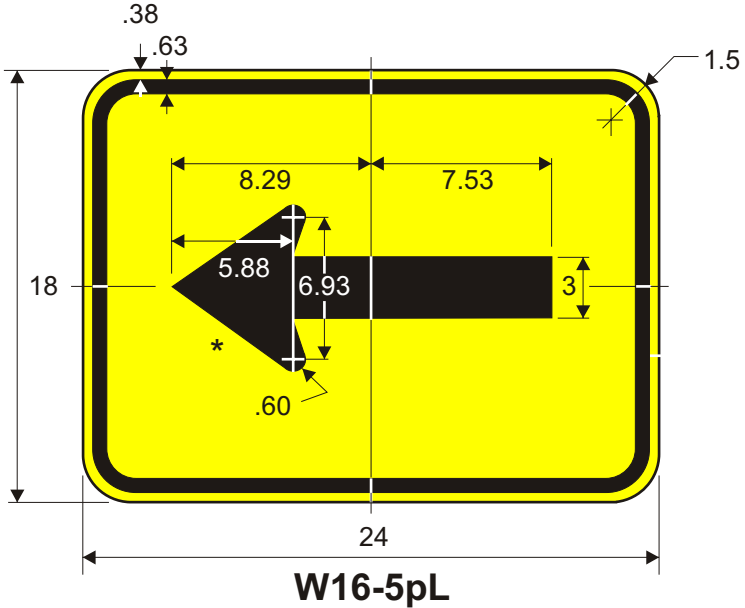

W16-6pR

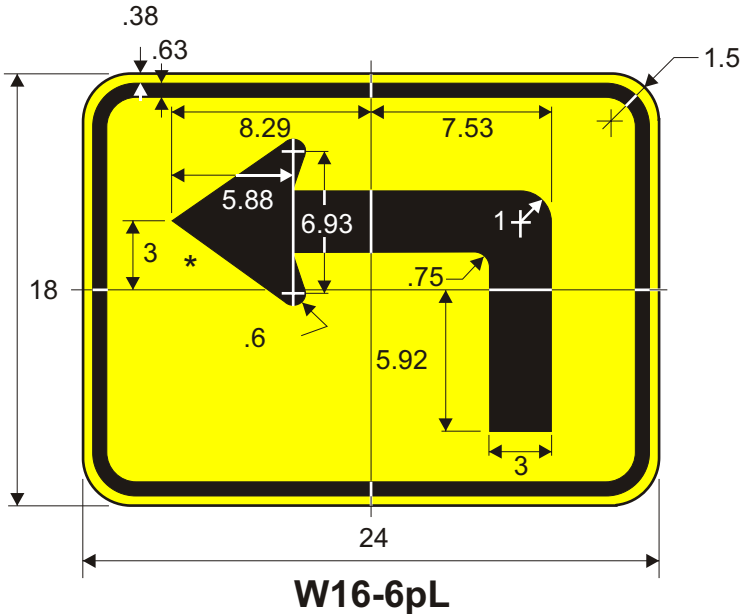

Border and Legend: Black
Background: Yellow

* See Appendix B-1 for Standard Arrow Details.

W16-7P

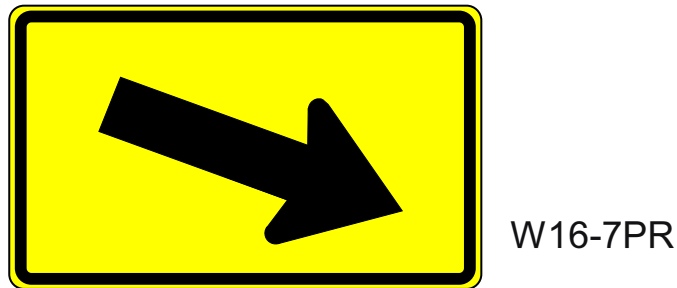
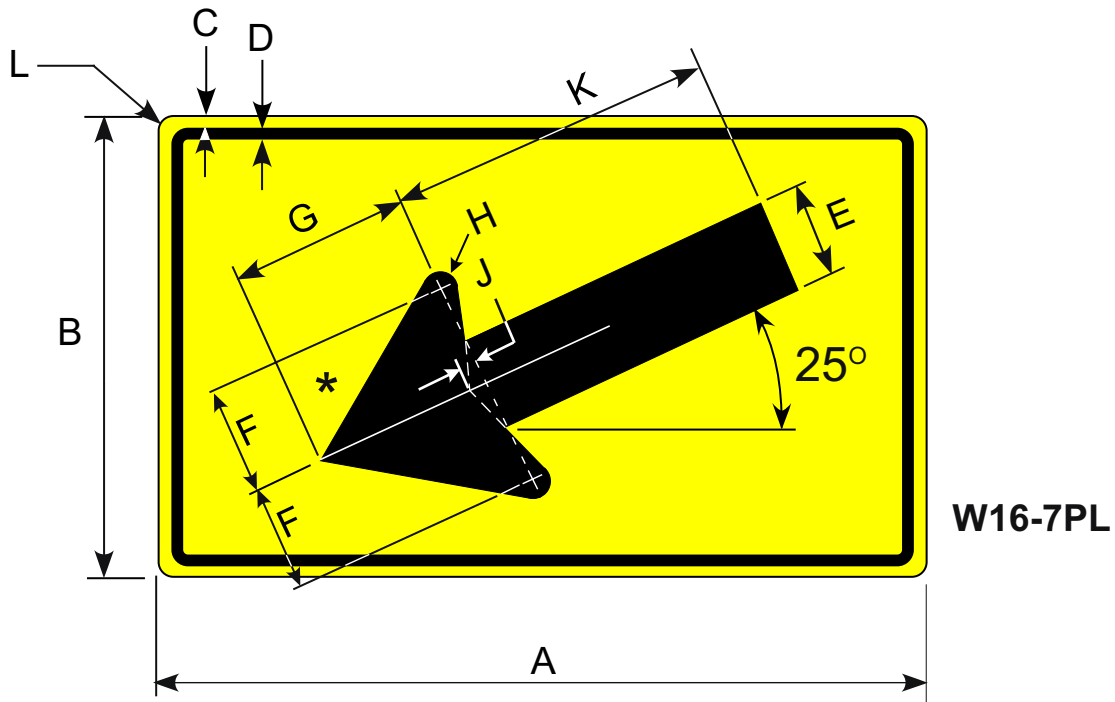

Border and Legend: Black
 Background: Yellow or Florescent Yellow
 Green (match color of supplemented sign)

* See Appendix B-1 for Standard Arrow Details.

Road Class	Dimensions (inches)										
	A	B	C	D	E	F	G	H	J	K	L
Minimum	24	12	0.50	0.50	2.75	3.0	5.56	0.56	0.44	10	1.88
Conver/Expwy	30	18	0.63	0.88	3.5	4.0	7.13	0.69	0.56	13	1.88



* See Appendix B-1 for Standard Arrow Details.

Border and Legend: Black
Background: Yellow

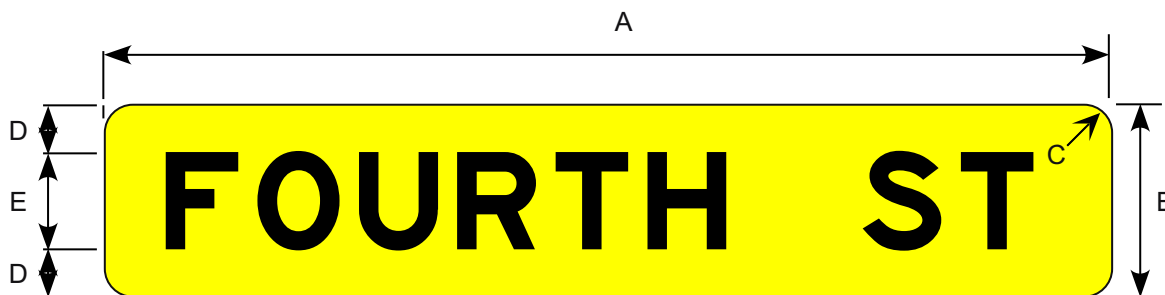

Border and Legend: Black
 Background: Yellow

Road Class	Dimensions (inches)				
	A	B	C	D	E
Conv & Min	VAR	12	1.5	3.5	5C
Expwy	VAR	12	2.0	3.0	6C

W16-9P

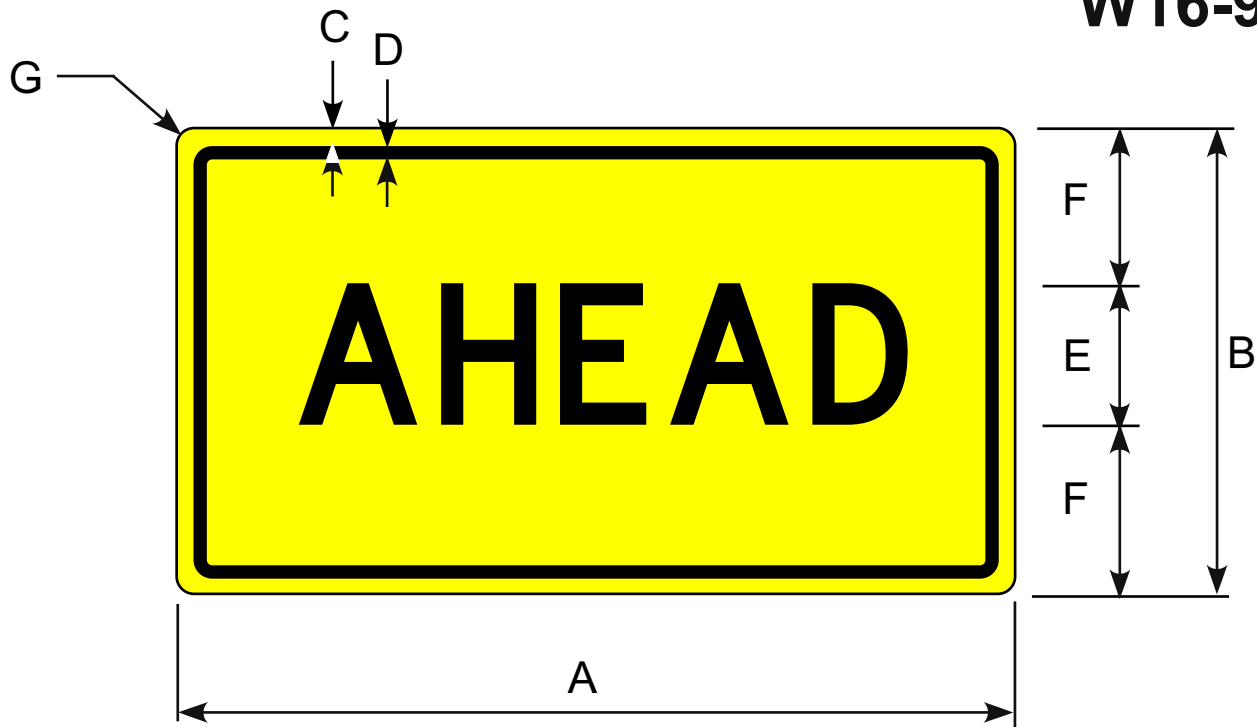

Border and Legend: Black
 Background: Yellow or Orange

Road Class	Dimensions (inches)						
	A	B	C	D	E	F	G
Minimum	24	12	0.50	0.50	4D	4.0	1.88
Conventional	36	18	0.63	0.88	6D	6.0	2.25
Expwy/Fwy	48	30	0.75	1.25	8D	11	3.0

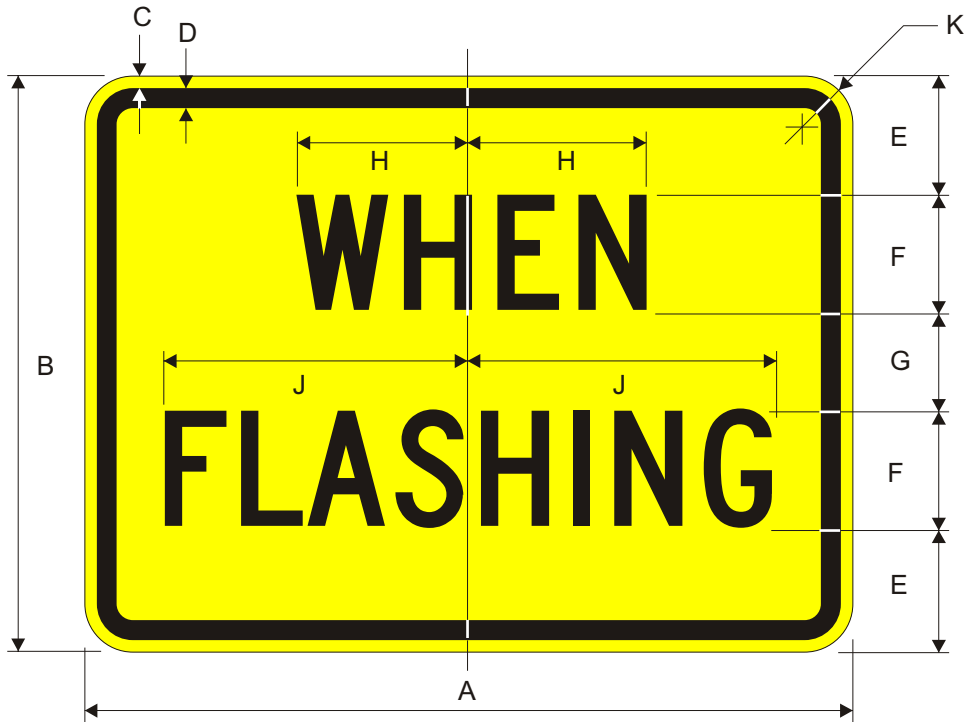

For Use With CW20-7B BE PREPARED TO STOP sign.

Border and Legend: Black
Background: Yellow

Road Class	Dimensions (inches)									
	A	B	C	D	E	F	G	H	J	K
Min	30	24	0.5	0.75	5	5C	3	7.268	12.782	1.875
Conv.	36	30	0.625	0.875	6	6C	6	8.915	16.175	2.25
Expy.	48	36	0.75	1.25	7	8C	6	11.885	21.565	3

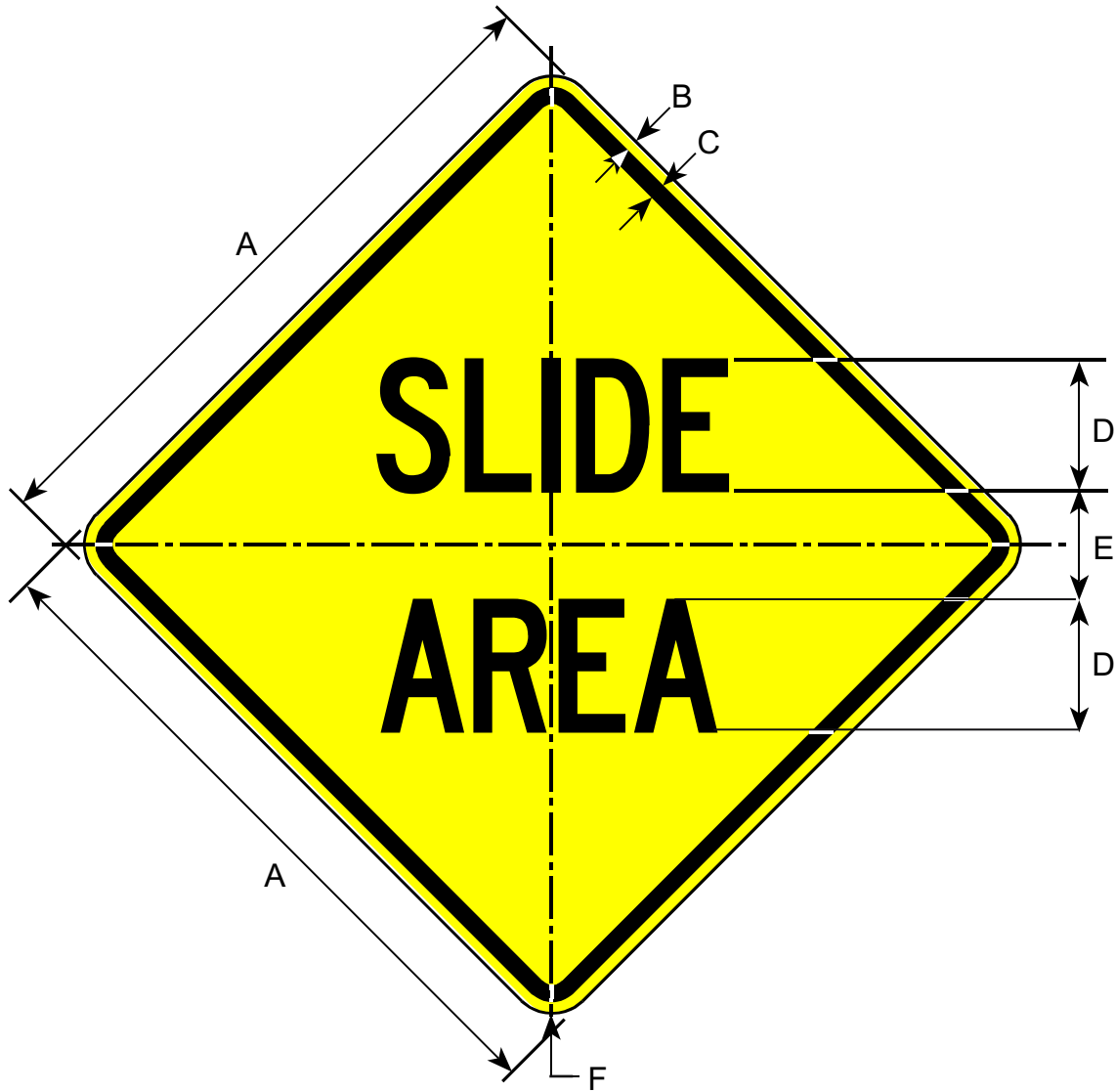

Border and Legend: Black
Background: Yellow

Prior to the 2002 publication of this manual, this sign was numbered W16-1.

Road Class	Dimensions (inches)					
	A	B	C	D	E	F
Minimum	30	0.5	0.75	6D	4.5	1.88
Conventional	36	0.63	0.88	7D	5.5	2.25
Expressway	48	0.75	1.25	10D	7.0	3.00

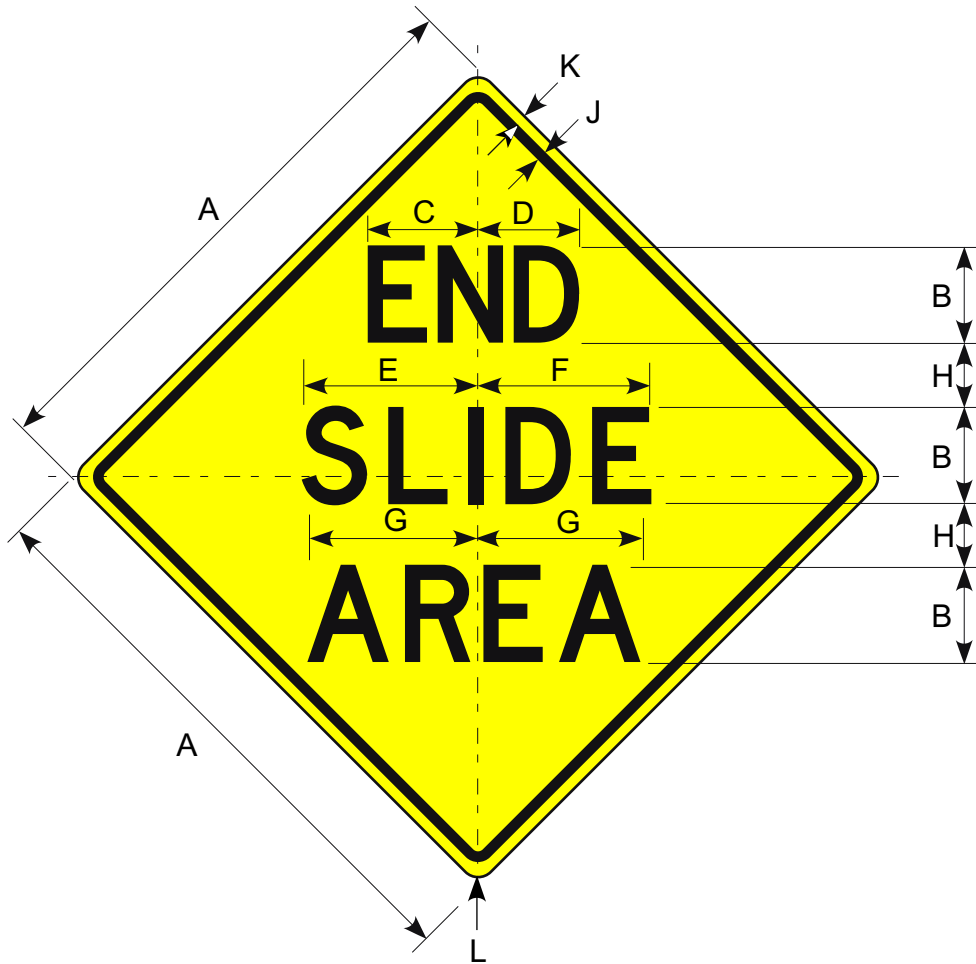

Border and Legend: Black
Background: Yellow

Prior to the 2002 publication of this manual, this sign was numbered W16-2.

Road Class	Dimensions (inches)										
	A	B	C	D	E	F	G	H	J	K	L
Minimum	30	5D	5.75	5.31	9.75	9.50	9.13	3.31	0.75	0.50	1.88
Conventional	36	6D	6.88	6.38	10.88	10.75	10.50	4.00	0.88	0.63	2.25
Expwy/Fwy	48	8D	9.13	8.50	14.81	15.63	14.06	5.31	1.25	0.75	3.00

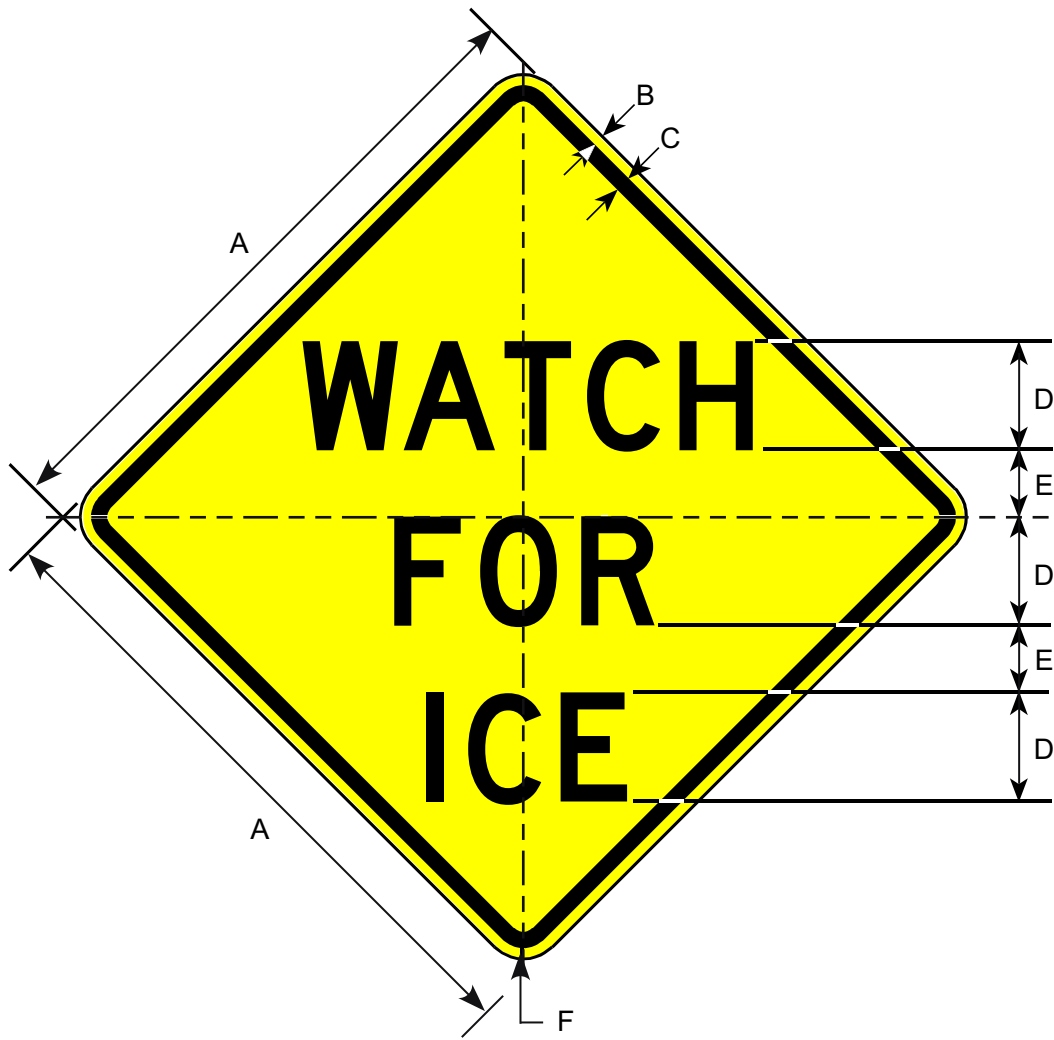

Border and Legend: Black
Background: Yellow

In the 2002 publication of this manual this sign replaced W16-3 ICY.

Road Class	Dimensions (inches)					
	A	B	C	D	E	F
Minimum	30	0.50	0.75	5D	3.00	1.88
Conventional	36	0.63	0.88	6D	4.00	2.25
Expwy/Fwy	48	0.75	1.25	8D	5.25	3.00



Border and Legend: Black
Background: Yellow

In the 2002 publication of this manual this sign replaced two previous signs, W16-4 FLOODED and W16-14 WATER CROSSING.

Road Class	Dimensions (inches)					
	A	B	C	D	E	F
Minimum	30	0.50	0.75	4D	1.25	1.88
Conventional	36	0.63	0.88	5D	1.75	2.25
Expwy/Fwy	48	0.75	1.25	7D	2.25	3.00

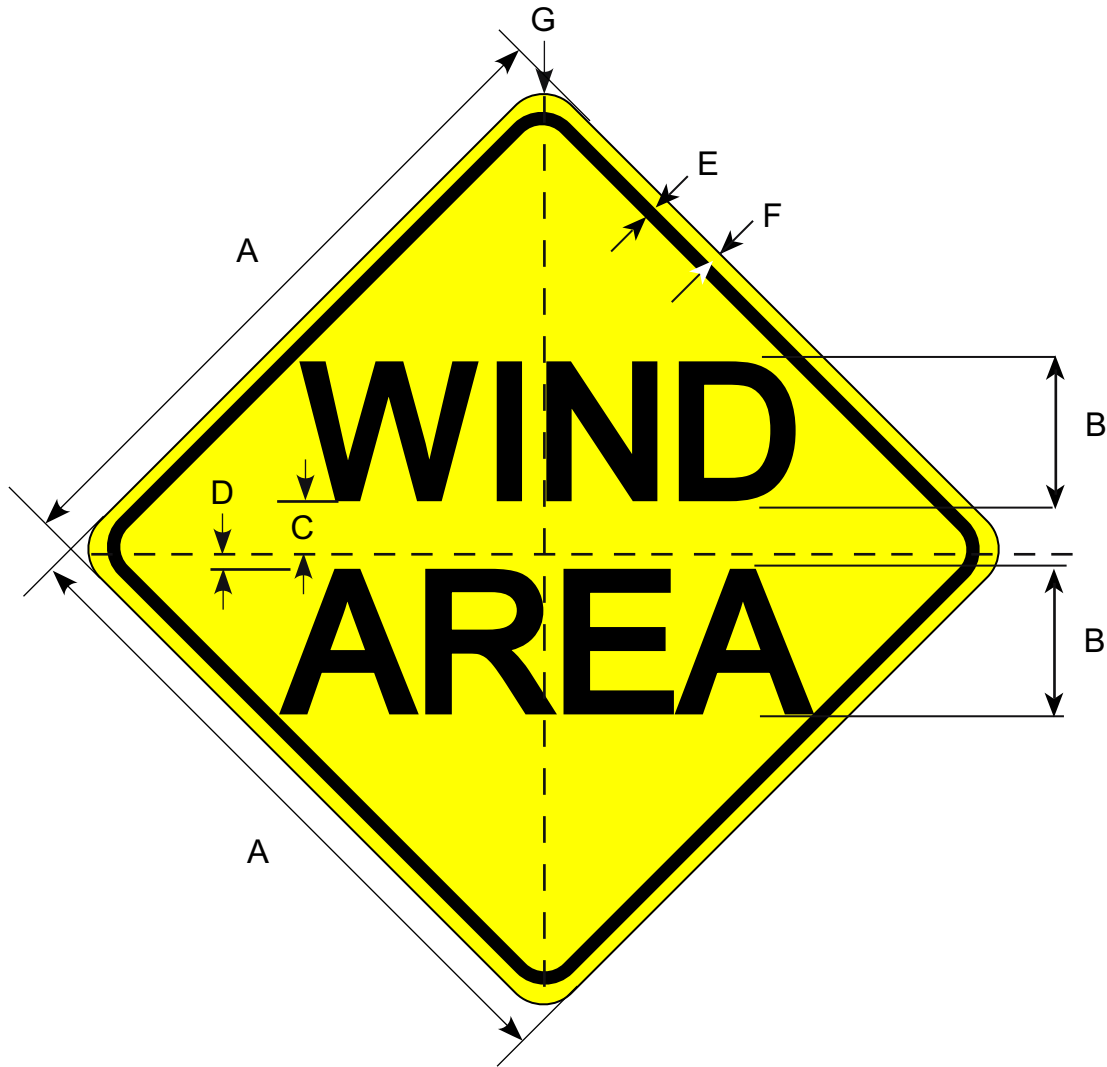

Border and Legend: Black
Background: Yellow

Prior to the 2002 publication of this manual, this sign was numbered W16-7.

Road Class	Dimensions (inches)						
	A	B	C	D	E	F	G
Minimum	30	6D	2.13	0.38	0.75	0.50	1.88
Conventional	36	8D	2.50	0.50	0.88	0.63	2.25
Expwy/Fwy	48	10D	3.00	0.75	1.25	0.75	3.00

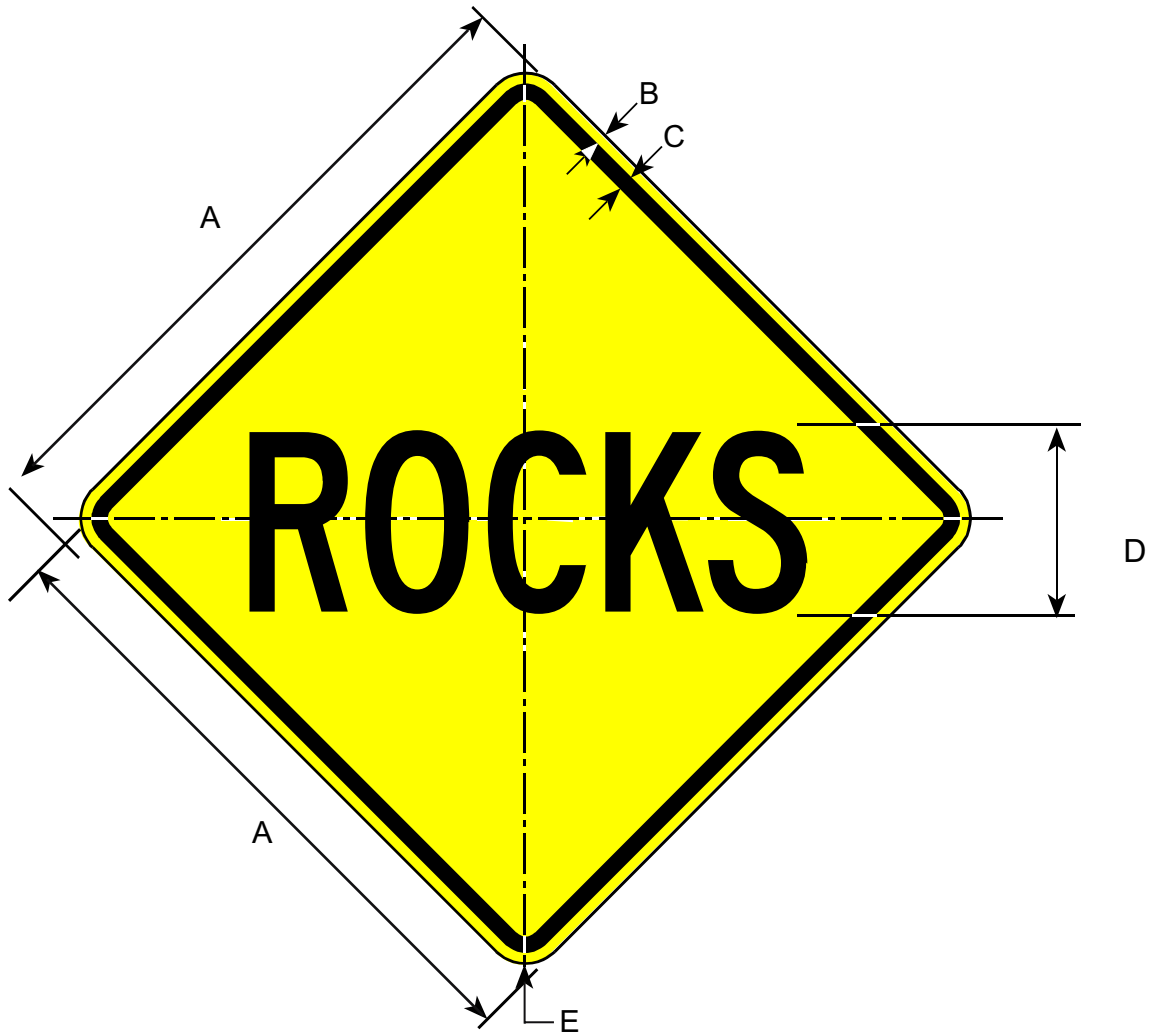

Border and Legend: Black
Background: Yellow

Prior to the 2002 publication of this manual, this sign was numbered W16-8.

Road Class	Dimensions (inches)				
	A	B	C	D	E
Minimum	30	0.50	0.75	8C	1.88
Conventional	36	0.63	0.88	10C	2.25
Expwy/Fwy	48	0.75	1.25	12C	3.00

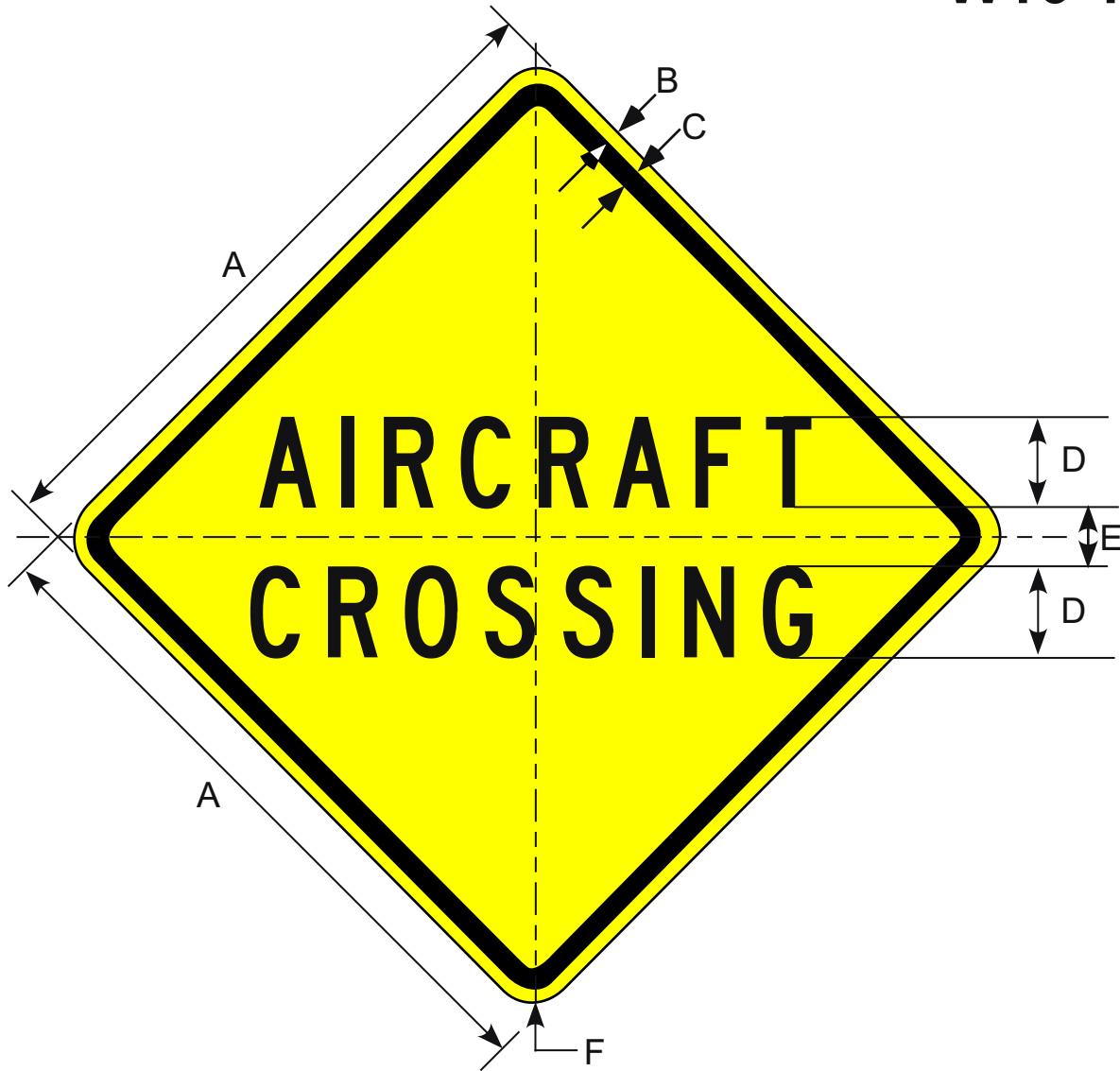

Border and Legend: Black
Background: Yellow

In the 2002 publication of this manual this sign replaced W16-9 AIRCRAFT.

Road Class	Dimensions (inches)					
	A	B	C	D	E	F
Minimum	30	0.50	0.75	4C	3.00	1.88
Conventional	36	0.63	0.88	5C	3.50	2.25
Expwy/Fwy	48	0.75	1.25	7C	4.50	3.00

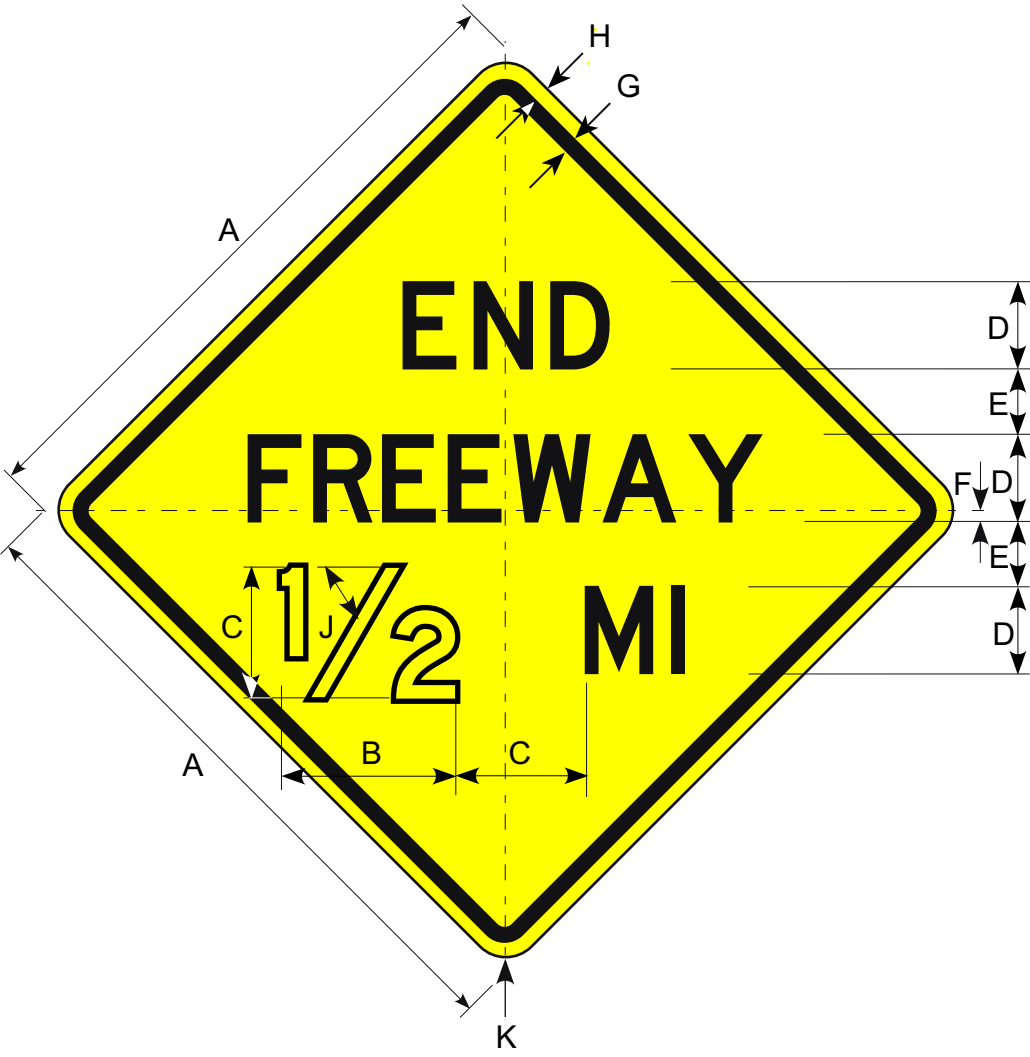

Border and Legend: Black
 Background: Yellow

Prior to the 2002 publication of this manual, this sign was numbered W16-10.

Road Class	Dimensions (inches)									
	A	B	C	D	E	F	G	H	J	K
Expwy/Fwy	60	16	12	8D	6.0	1.0	1.5	1.0	60°	3.75

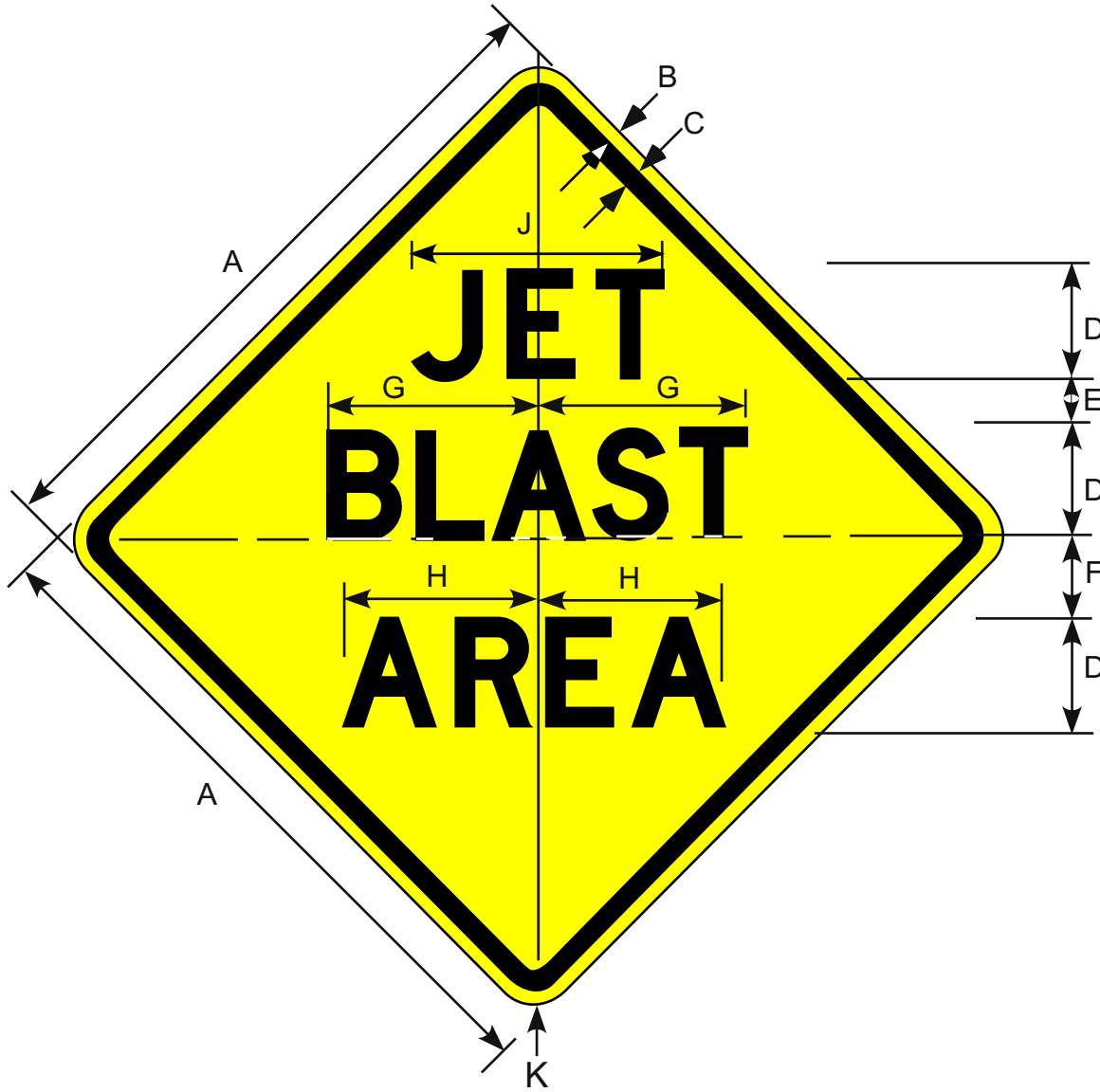

Border and Legend: Black
Background: Yellow

Prior to the 2002 publication of this manual, this sign was numbered W16-12.

Road Class	Dimensions (inches)									
	A	B	C	D	E	F	G	H	J	K
Minimum	30	0.50	0.75	5C	3.3	5.0	13.25	7.50	9.11	1.88
Conventional	36	0.63	0.88	6C	4.0	6.0	16	8.38	17.51	2.25
Expwy/Fwy	48	0.75	1.25	8C	6.0	8.0	21.25	11.13	13.94	3.0

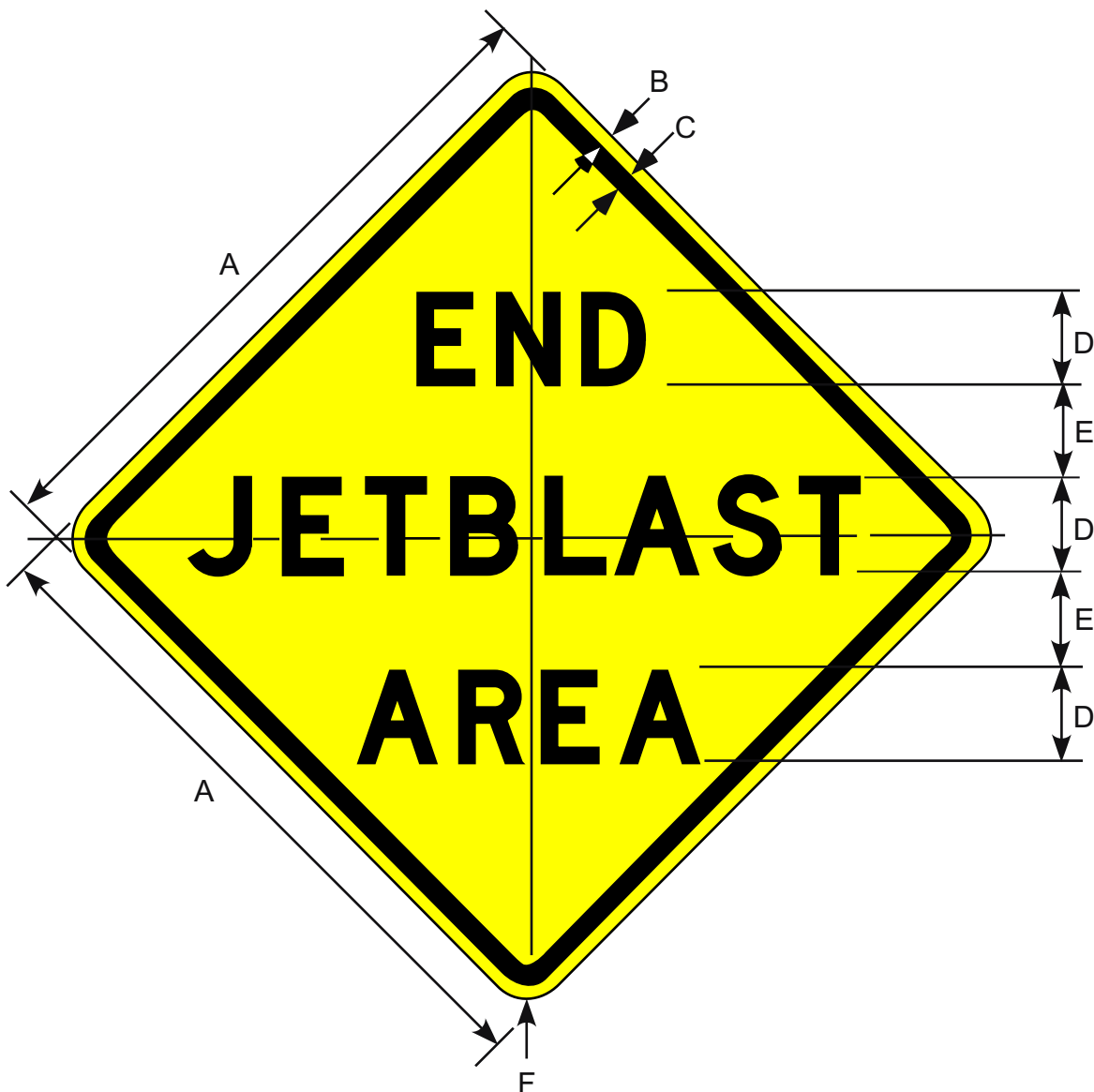

Prior to the 2002 publication of this manual, this sign was numbered W16-13.

Border and Legend: Black
Background: Yellow

Road Class	Dimensions (inches)					
	A	B	C	D	E	F
Minimum	30	0.50	0.75	5C	5.0	1.88
Conventional	36	0.63	0.88	6C	6.0	2.25
Expwy/Fwy	48	0.75	1.25	8C	8.0	3.0

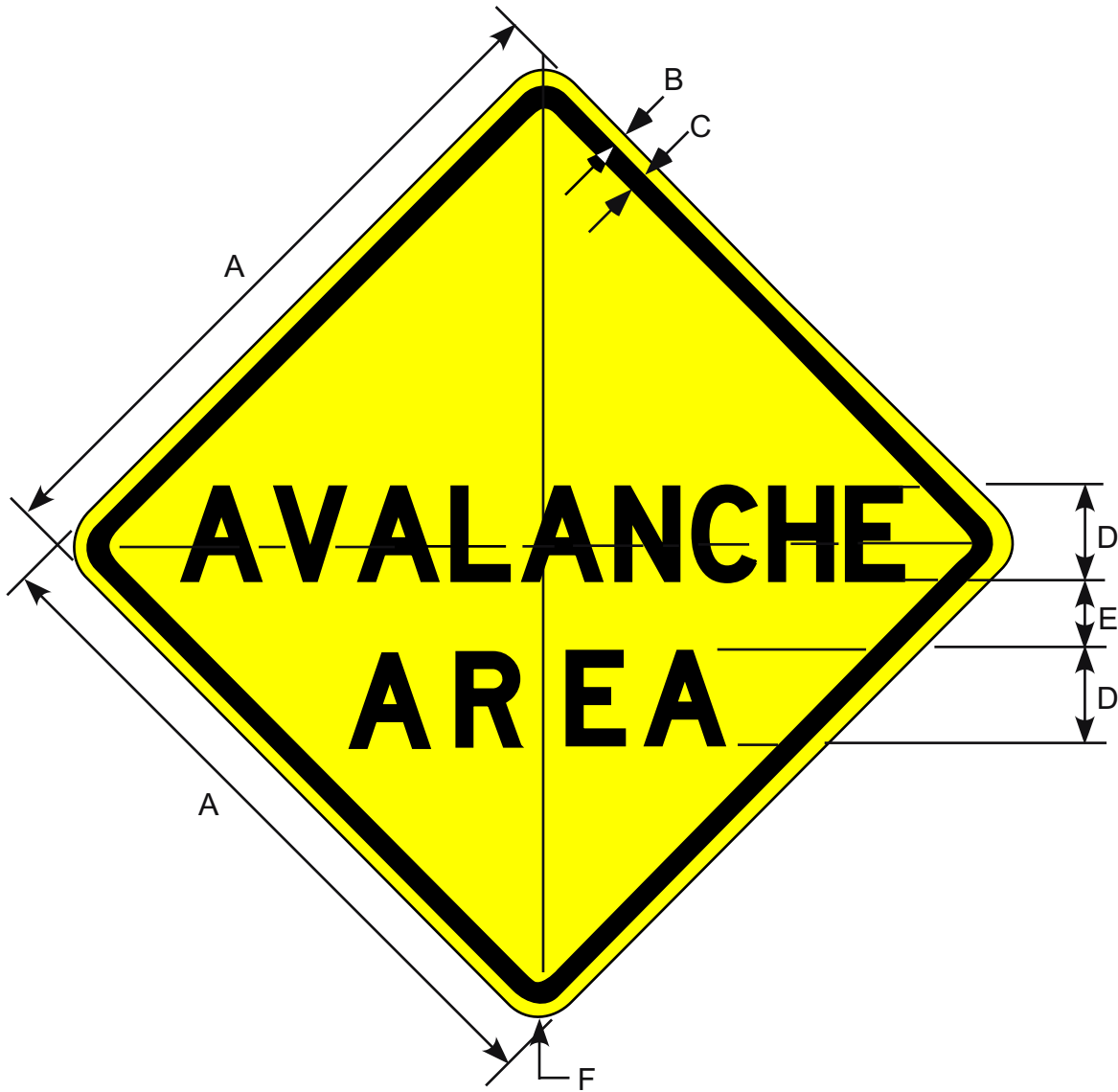

Prior to the 2002 publication of this manual, this sign was numbered W16-5.

Border and Legend: Black
Background: Yellow

Road Class	Dimensions (inches)					
	A	B	C	D	E	F
Minimum	30	0.50	0.75	5C	3.5	1.88
Conventional	36	0.63	0.88	6C	4.0	2.25
Expwy/Fwy	48	0.75	1.25	8C	5.38	3.0

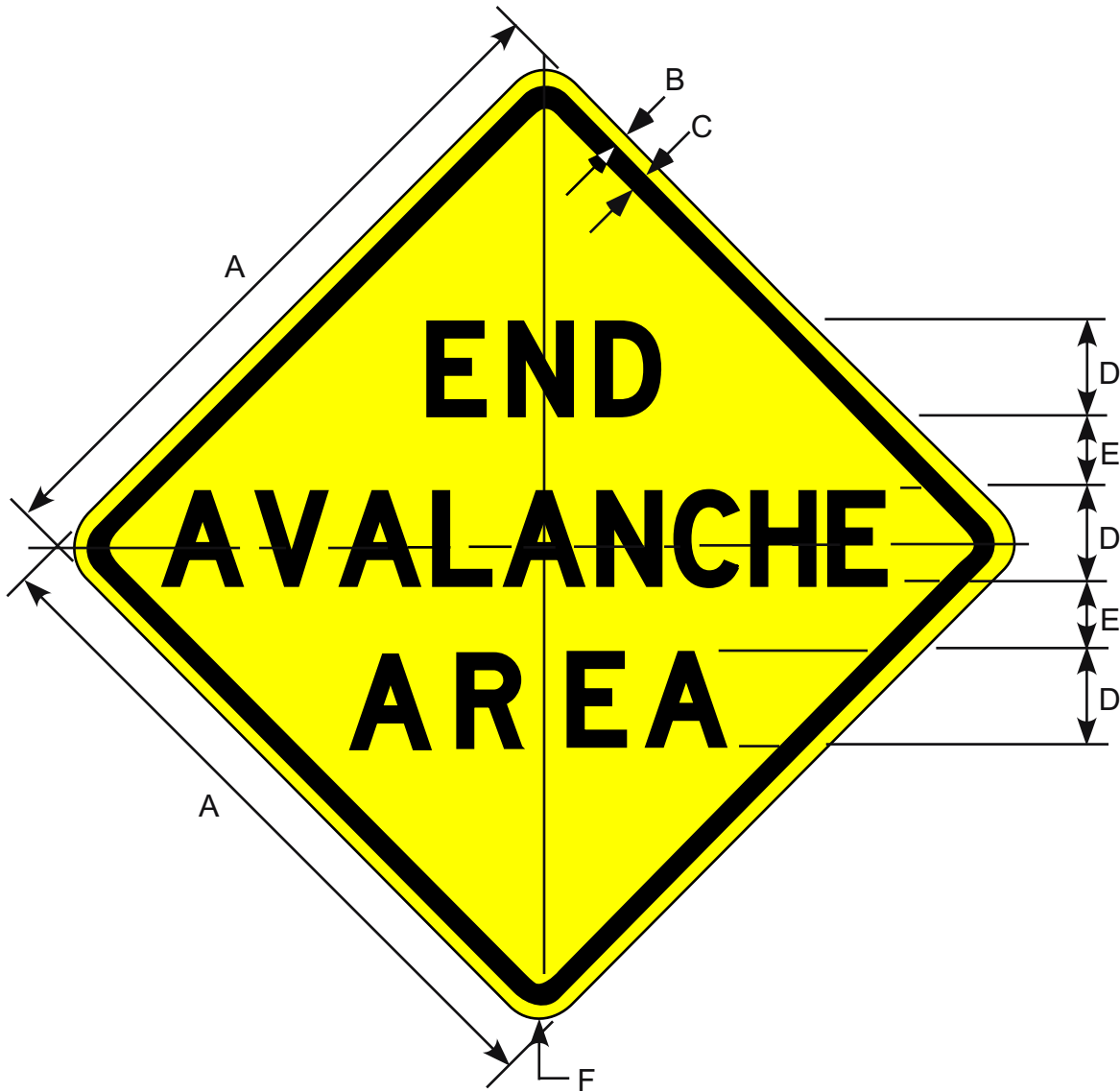

Prior to the 2002 publication of this manual, this sign was numbered W16-6.

Border and Legend: Black
Background: Yellow

Road Class	Dimensions (inches)					
	A	B	C	D	E	F
Minimum	30	0.50	0.75	5C	3.0	1.88
Conventional	36	0.63	0.88	6C	4.0	2.25
Expwy/Fwy	48	0.75	1.25	8C	5.25	3.0



Border and Legend: Black
 Background Top: Yellow
 Background Bottom: White

Road Class	Dimensions (inches)								
	A	B	C	D	E	F	G	H	J
Expwy/Fwy	90	48	0.75	1.25	5	8C	9	18	6



Border and Legend: Black
Background: Yellow

Road Class	Dimensions (inches)							
	A	B	C	D	E	F	G	H
Min & Conv	30	36	0.5	0.75	4D	3	3	1.88

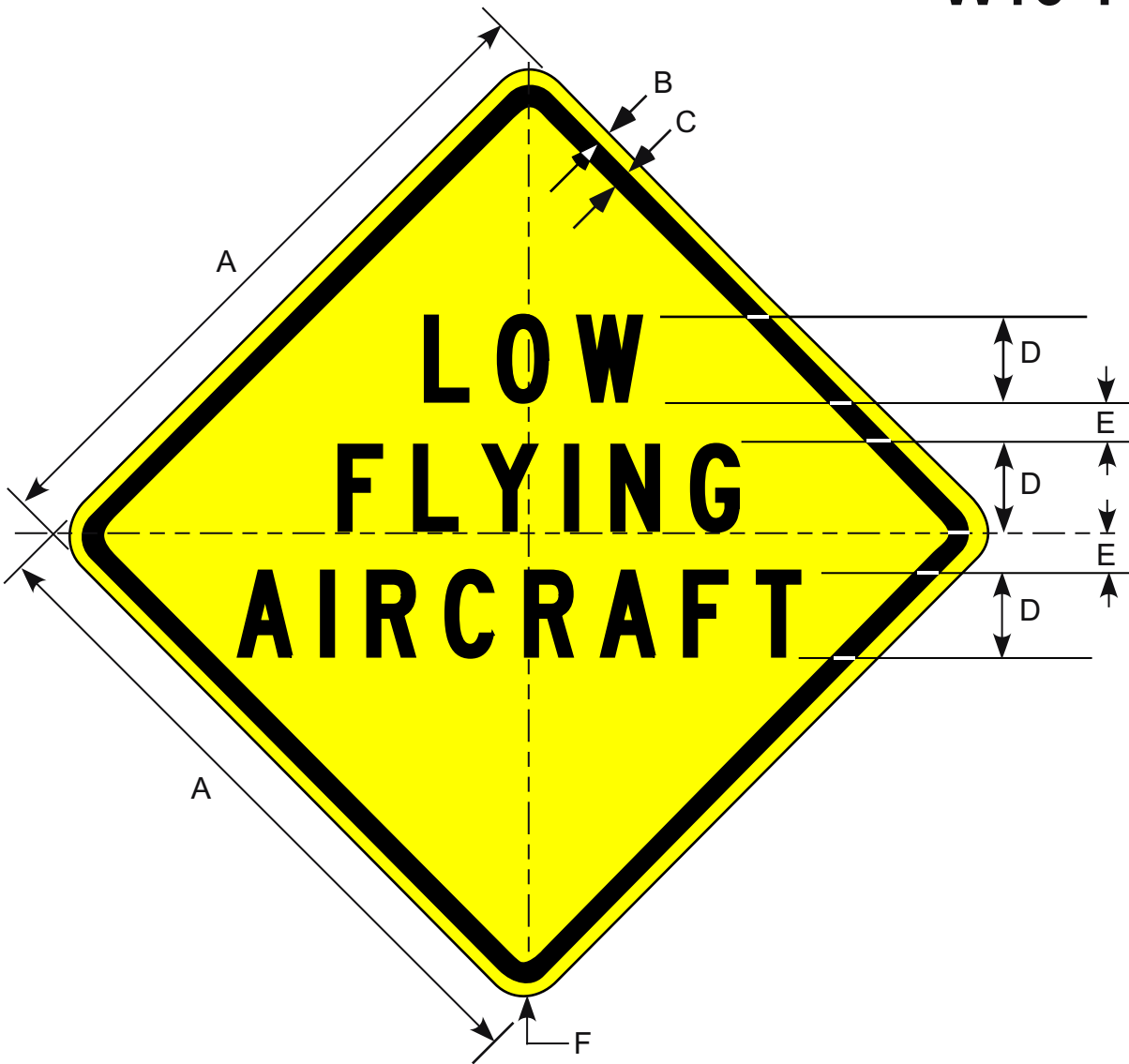

Border and Legend: Black
Background: Yellow

Road Class	Dimensions (inches)					
	A	B	C	D	E	F
Minimum	30	0.50	0.75	5C	2.5	1.88
Conventional	36	0.63	0.88	6C	2.75	2.25
Expwy/Fwy	48	0.75	1.25	8C	3.5	3.0

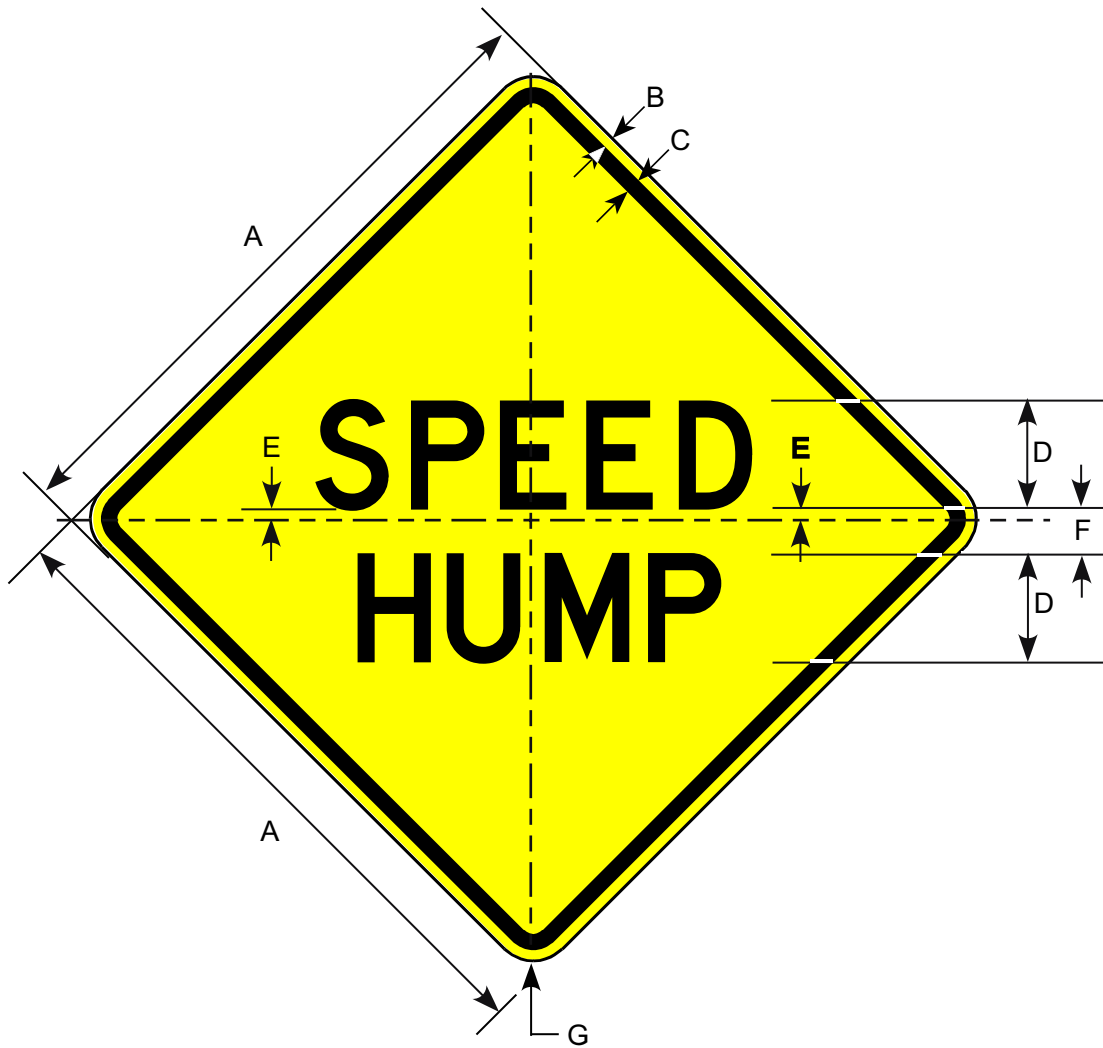

Border and Legend: Black
Background: Yellow

Road Class	Dimensions (inches)						
	A	B	C	D	E	F	G
Minimum	30	0.50	0.75	5D	0.48	2.56	1.88
Conventional	36	0.63	0.88	6D	0.76	3.00	2.25



Border and Legend: Black
Background: Yellow



Border and Legend: Black
Background: Yellow

