



Alaska Department of Transportation and Public Facilities

Alaska Sign Design Specifications

Effective November 15, 2006

Contents

Section Name	Section	Pages
Introduction and General Specifications	2	i to iv
Index to Sign Drawings - by Sign <u>Number</u>	3	In-1 to In-16
Index to Sign Drawings - by Sign <u>Message</u>	4	Im-1 to Im-16
Sign Drawings		
Construction Warning	5	CW1-1 to CW24-1B
Destination Signs—Conventional Rds	6	D1-1 to D3-2D
Parking Area	7	D4-1 to D4-100
Rest Area	8	D5-1 to D5-104
Scenic Area	9	D6-1 to D6-4A
Recreation	10	D7-1 to D7-RW
Weigh Station/Customs	11	D8-1 to D8-104
General Services	12	D9-1 to D9-308
Mile Posts	13	D10-1 to D10-104A
Bike Route, Weather, Car Pool Info	14	D11-1 to D12-102
Freeway Entrance	15	D13-3 to D13-3A
Destination Signs—Expwys&Fwys	16	E1-5 to E11-1
Emergency Management	17	EM-2 to EM-100
Construction Guide	18	G20-1 to G20-4
General Information	19	I-1 to I-201
Business LOGO	20	LG-F1x2 to LG-R1x3
Markers	21	M1-2 to M12-1
Object Markers	22	OM1-1 to OM4-3
Regulatory	23	R1-1 to R16-115
School	24	S1-1 to S6-1
Warning	25	W1-1 to W25-2
Appendix A: Design of Guide Signs	26	A1-A5
Appendix B: Arrow Details	27	B1-B5
Appendix C: Standard Alphabets	28	C1-C11
Appendix D: Sign Blank Details	29	D1-D5

INTRODUCTION AND GENERAL SPECIFICATIONS

Introduction

The Alaska Sign Design Specifications (ASDS) contains size and layout information for approved highway signs. Use these specifications for all traffic signs on Alaska public roads. We recommend using them on private roads as well.

This publication is a supplement to the Alaska Traffic Manual (ATM), which specifies appropriate use and placement of traffic control devices, including signs.

The ASDS is intended to enhance road safety and operation by specifying uniform, understandable, and effective traffic signs for Alaska roads.

Related Documents

The ATM is comprised of the current [Alaska Supplement](#), published by the Alaska Department of Transportation and Public Facilities (DOT&PF), and the [Manual on Uniform Traffic Control Devices \(MUTCD\)](#), published by the Federal Highway Administration. See the ATM for the version of the MUTCD that is currently effective in Alaska.

The Alaska DOT&PF [Highway Preconstruction Manual](#) contains additional information on sign supports and other items. It pertains to DOT&PF construction projects.

The DOT&PF [Standard Specifications for Highway Construction](#) contains descriptions, material requirements, and construction methods for traffic signs and other items. It pertains to DOT&PF construction projects.

The 2004 FHWA [Standard Highway Signs \(SHS\)](#) contains standard highway sign details adopted by the federal government. The ASDS, which includes many signs from the SHS, is the authoritative reference in Alaska and supersedes the SHS.

Sign lettering shall conform to Appendix C. .

Obtaining the ASDS and Related Documents

You may purchase documents published by the DOT&PF from the Alaska Department of Transportation and Public Facilities, 3132 Channel Drive, Room 115, Juneau, Alaska 99801 (907-465-2985). They are also available for free download at the DOT&PF Design and Construction Standards web site at:

<http://www.dot.state.ak.us/stwddes/dcspubs/index.shtml>

You may obtain the MUTCD and revisions from the Superintendent of Documents, U.S. Government Printing Office, P.O. Box 371954, Pittsburgh, PA 15250-7954, Stock No. 650-001-00001-0.

You may also purchase it on the web at

<http://mutcd.fhwa.dot.gov/ser-pubs.htm>.

You may obtain [The Standard Highway Signs Book](#), Stock No. 950-044-00000-4, from the same physical and web addresses as the MUTCD.

For the [Standard Alphabets for Highway Signs](#), 1966 Edition and [Standard Alphabets for Highway Signs and Pavement Markings](#), 1977 Metric Edition, write to the Federal Highway Administration (FHWA), Office of Transportation Operations (HOTO), 400 7th Street, SW, Room 3416, Washington, DC 20590.

Note. These web addresses and references were current when the ASDS was published.

ASDS Revisions

We will periodically post revisions to this publication on the DOT&PF web site listed above. We will no longer mail a written notice of revisions. Manual holders are responsible for checking the website and keeping their manuals up to date.

Revisions to these specifications become effective on the date of web publication. When traffic signs are installed under State contracts, the ASDS in effect as of the initial date of contract advertising shall apply, unless specified otherwise in contract documents.

Conformity with Standards

Signs on state-owned public streets and highways in

Alaska shall conform to these specifications unless specifically exempted by the DOT&PF State Traffic Engineer. In accordance with AS 28.01.010, The Alaska Uniform Traffic Laws Act, signs on other public streets and highways shall conform unless conformance is not practicable. Sign supports shall be crashworthy (in conformance with the requirement of [National Highway Cooperative Research Program Report 350](#)) or located outside of the clear zone (as defined in the DOT&PF [Highway Preconstruction Manual](#)). Sign installations and usage shall conform to the ATM.

Sign Numbering

In many cases, sign numbers differ from those in past versions of the ASDS. Generally, the new numbers either correspond with those in the 2003 MUTCD or, if there are no corresponding signs, have suffixes high enough to not conflict with future additions to the MUTCD. Usually, signs used in Alaska but not shown in the MUTCD have a “-100” or higher suffix. Exceptions include D1, D2, D3 and E series signs where most sign numbers used in the past were retained because there is little overlap or conflict with the MUTCD.

Existing documents such as standard drawings, manuals, and policies may refer to signs by their old numbers. To provide a cross-reference, the old numbers are listed in the index and, when numbers have changed, on sign drawings.

Notes on Using the ASDS

In most cases, variable sign characters are shown as outlines. Exception: when it is obvious that characters are variable, as with destinations or street names, they are shown normally.

Sign drawings are ordered as shown in the Index. Because some pages have multiple signs, sign order does not always follow an exact alpha-numeric sequence. However, signs will always be within a few pages of being sequential.

General Specifications

Sign Sizing by Roadway Class

Roadway classes are defined as follows:

Roadway Class	Definition
Bike	Signs intended for the exclusive use of bicyclists
Minimum	Local roads (as defined by AASHTO) with no more than one lane in each direction and speed limits of 25 MPH or less.
Conventional	Streets or highways other than freeways, expressways, and roads that fall under the Minimum class above.
Expressway	Divided highways with partial control of access
Freeway	Divided highways with full control of access
Oversized	Where special emphasis is needed

Sign dimensions shown on the sign drawings are standard sizes for each roadway class. You may use larger sizes where greater legibility or emphasis is desired. Larger “Oversized” sizes are provided for some signs. Maintain the specified shapes, colors, and proportions when enlarging other signs.

Color

Sign color specifications shall comply with the MUTCD.

Symbols

Symbol designs shall be essentially like those shown on sign drawings. You may download electronic images from the ASDS sign drawings on the Internet and scale them to the appropriate size.

Unless otherwise shown on sign drawings, symbols should be centered.

Word Messages

Use the sign text shown in these Specifications for standard sign legends. Legends for directional signs and other non-standard wordings should be as brief as

possible.

Long place names or messages often present difficulties in sign layout. Although the width of directional signs is determined by legend length, there are sometimes practical limits to sign width.

You may use reduced spacing between letters where some condensation in legend length is necessary. However, spacing between individual letters shall not be reduced more than 25%, and no reduction shall be made unless permitted in writing by the agency with road authority.

Lettering

Standard letter dimensions and spacings are addressed in Appendix C.

Unless otherwise shown on sign drawings, text should be centered.

With the exception of road or destination names on guide signs, sign lettering shall be upper-case. Unless otherwise shown, road or destination names shall be lower-case, with initial upper-case.

Sign lettering is designated by size and series. Letter series determines the width of characters and intervening spaces. “Series 2000” letter series ranges from B to F (narrow to wide). “Clearview” letter series range from 5W to 5WR (wider to narrower). As examples, a “6C” designation means a letter height of 6 inches with a series C width, while a 10-5W designation means a 10 inch letter using a Clearview series 5W width.

Sign Borders

With few exceptions, the signs in this manual have a border of the same color as the legend, at or just inside the edge. This improves the appearance of the signs and makes them more conspicuous. A dark border shall be set in from the edge, while a white border shall extend to the edge of the plate. See the Appendix for standard border dimensions.

If the border color is not defined on a sign drawing, the border shall be the same color as the legend.

Tolerances

All dimensions given are assumed to have a tolerance of $\pm 1/16"$. However, if the standard product of a sign manufacturer presents essentially the desired format and varies from the dimensions given by less than 5%, the standard product will be considered in compliance with these specifications.

Illumination and Reflectorization

Unless otherwise noted, all traffic signs shall be reflectorized or illuminated to show the same shape and similar color day and night.

When signs are reflectorized, all colors except black shall be fabricated from retro-reflective material, unless otherwise noted.

INDEX BY SIGN NUMBER

In-1 to In-16

Index - Sorted by Sign Number

Sign Number	Pre-2006 Sign Number (If Different)	Message
CW1-1		Arrow 90 Degree (Symbol)
CW11-100		CAUTION SNOW REMOVAL EQUIPMENT ON ROAD NEXT XX MILES
CW11-101		CAUTION SNOW REMOVAL EQUIPMENT MAY BE IN YOUR LANE
CW1-2		Curve (Symbol)
CW12-1		Left/Right (Down Arrows) (Symbol)
CW12-2		Low Clearance Symbol (Two Arrows) (Symbol)
CW1-3		Arrow 90 Degree (Symbol)
CW13-1		35 MPH (Advisory Speed Plate)
CW13-4		ON RAMP
CW1-4		Reverse Curve (Symbol)
CW14-3		NO PASSING ZONE
CW1-4B		Two Lane Curves Ahead (Symbol)
CW1-4C		Three Lane Curves Ahead (Symbol)
CW1-6		Large Arrow, One Way (Symbol)
CW1-7		Two Way (large Arrow) (Symbol)
CW1-8		Chevron (Symbol)
CW20-100	CW21-4 (<2002)	ROAD WORK _____ See Interim Addenda
CW20-101	CW21-2 (<200)	DETOUR AHEAD _____ See Interim Addenda
CW20-102	AK-CW20-100 (<2003)	DOUBLE FINES
CW20-3		ROAD CLOSED _____ See Interim Addenda
CW20-4		ONE LANE ROAD _____ See Interim Addenda
CW20-5		RIGHT LANE CLOSED _____ See Interim Addenda
CW20-5A		RIGHT TWO LANES CLOSED _____ See Interim Addenda
CW20-5B		CENTER LANE CLOSED _____ See Interim Addenda
CW20-7		Flagger Sign (Symbol) See Interim Addenda
CW20-7B	CW20-8 (<2003)	BE PREPARED TO STOP See Interim Addenda
CW21-1A		Working Crew (Symbol)
CW21-2		FRESH OIL/TAR
CW21-3		ROAD MACHINERY _____
CW21-5		SHOULDER WORK
CW21-5A		RIGHT (LEFT) SHOULDER CLOSED See Interim Addenda
CW21-6		SURVEY CREW
CW21-7		UTILITY WORK _____
CW22-1		BLASTING ZONE AHEAD See Interim Addenda
CW22-2		TURN OFF 2-WAY RADIOS AND PHONES
CW22-3		END BLASTING ZONE
CW23-100B	CW23-1B (<2002)	SLOW Paddle (Back)
CW23-100F	CW23-1A (<2002)	STOP Paddle (Front)
CW24-1		Double Reverse Curve (1-lane) (Left, Right) (Symbol)
CW24-1A		Double Reverse Curve (2-lane) (Left, Right) (Symbol)
CW24-1B		Double Reverse Curve (3-lane) (Left, Right) (Symbol)
CW3-100	W3-100 (<2003)	NEW TRAFFIC PATTERN
CW3-1A		Stop Ahead (Symbol)
CW3-2A		Yield Ahead (Symbol)
CW3-3	CW3-3B (<2002)	Signal Ahead (Symbol)
CW3-3P		NEW SIGNAL (Plate)
CW4-1		Merge (Symbol)

Index - Sorted by Sign Number

Sign Number	Pre-2006 Sign Number (If Different)	Message
CW4-1A		THRU TRAFFIC MERGE LEFT See Interim Addenda
CW4-1B		THRU TRAFFIC MERGE RIGHT See Interim Addenda
CW4-2		Lane Ends (Symbol)
CW4-3		Added Lane (Single Through Lane) (Symbol)
CW5-1		ROAD NARROWS
CW5-2		NARROW BRIDGE
CW5-3		ONE LANE BRIDGE
CW5-4		RAMP NARROWS
CW6-1		Divided Highway Begins (Symbol)
CW6-100		One Lane with 2 Advancing Lanes
CW6-2		Divided Highway Ends (Symbol)
CW6-3		Two Way Traffic (Symbol)
CW6-4		Two Way Traffic (Symbol)
CW7-1		Truck on Hill (Symbol)
CW8-1		BUMP
CW8-100		PAVEMENT BREAK
CW8-11		UNEVEN LANES
CW8-12		NO CENTER STRIPE
CW8-1A		BUMPS
CW8-2		DIP
CW8-2A		DIPS
CW8-3		PAVEMENT ENDS
CW8-4		SOFT SHOULDER
CW8-5		Road Slippery When Wet (Symbol)
CW8-5P		SLIPPERY WHEN WET (Plate)
CW8-6		TRUCK CROSSING
CW8-7		LOOSE GRAVEL
CW8-8		ROUGH ROAD
CW8-9		LOW SHOULDER
CW8-9B	CW8-10 (<2002)	NO SHOULDER
CW9-1		RIGHT (LEFT) LANE ENDS See Interim Addenda
CW9-2		LANE ENDS MERGE LEFT (RIGHT) See Interim Addenda
CW9-3		CENTER LANE CLOSED AHEAD (LEFT, RIGHT) See Interim Addenda
D10-1, 2, 3, 400		Single-Faced 1, 2, 3, and 4 digit Mile Marker Signs
D10-101, 102, 103, 104		Double-Faced 1, 2, 3, and 4 digit Mile Marker Signs
D10-101A, 102A, 103A, 104A		Double-Faced 1, 2, 3, and 4 digit Mile Marker Intermediate Reference Location Signs
D10-1A, 2A, 3A		Intermediate Reference Location Signs
D1-1		One Line Destination & Arrow
D1-100		Roundabout Destination
D11-1		BIKE ROUTE (w/ Symbol)
D1-1A		One Line Destination, Arrow & Mileage
D1-2-1	D1-2 (<2002)	Two Line Destination & Arrow (Destinations in same direction)
D12-100	D12-1 (<2002)	WEATHER INFO TUNE RADIO TO _____
D12-101	D12-2 (<2002)	CARPOOL INFO 345-POOL
D12-102		CARPOOL INFO 345-POOL (Symbol)

Index - Sorted by Sign Number

Sign Number	Pre-2006 Sign Number (If Different)	Message
D1-2-2	D1-2 (<2002)	Two Line Destination & Arrow (Destinations in different directions)
D12-5		511 TRAVEL INFO
D1-2A-1	D1-2A (<2002)	Two Line Destination, Arrow & Mileage (Destinations in same direction)
D1-2A-2	D1-2A (<2002)	Two Line Destination, 2 Arrows & Mileage (Destinations in different directions)
D1-3-2	D1-3 (<2002)	Three Line Destination & 2 Arrows (2 Destinations in one direction, 1 in another)
D13-3		Freeway Entrance
D1-3-3	D1-3 (<2002)	Three Line Destination & 3 Arrows (All destinations in different directions)
D13-3A		Freeway Entrance (Oblique Arrow)
D1-3A-2	D1-3A (<2002)	Three Line Destination, 2 Arrows & Mileage (2 destinations in same direction, 1 in another)
D1-3A-3	D1-3A (<2002)	Three Line Destination, 3 Arrows & Mileage (All destinations in different directions)
D2-1		One Line Destination & Mileage
D2-2		Two Line Destination & Mileage
D2-3		Three Line Destination & Mileage
D3-1		Street Name (small sign)
D3-1A		Street Name w Block Number (small sign)
D3-1B		One Line Overhead Street Name
D3-1C		Two Line Advance Street Name and Arrow
D3-1D		Street Name w Block Number (small sign)
D3-2		Advance Street Name (Arrow in one direction)
D3-2B		Advance Street Name, 2 Lines, 2 Arrows, opposite directions
D3-2C		NEXT SIGNAL 3-Line Advance Street Name
D3-2D		NEXT INTERSECTION 4-Line Advance Street Name
D4-1		PARKING (Arrow)
D4-100		PARK & RIDE (Car & Bus Symbol)
D4-2		PARK & RIDE (Car Symbol)
D5-1		REST AREA 2 MILES
D5-100		NEXT REST AREA 44 MILES
D5-101		REST AREA NEXT RIGHT
D5-102		REST AREA
D5-103		1/4 MILE
D5-104		REST AREA (Arrow)
D5-2	I-21 (<2002)	REST AREA (Arrow)
D5-3		PARKING AREA X MILES
D5-3C		PARKING AREA X MILES (Horizontal Arrow)
D5-4		PARKING AREA (Oblique Arrow)
D5-5		ROADSIDE TABLE (Horizontal Arrow)
D5-5A		Roadside Table (Symbol)
D5-5B		ROADSIDE PARK (Horizontal Arrow)
D5-5C		PICNIC AREA Horizontal Arrow
D5-5D		ROADSIDE PARK XX MILES
D5-5E		ROADSIDE TABLE XX MILES
D5-6		NEXT REST AREA XX MILES

Index - Sorted by Sign Number

Sign Number	Pre-2006 Sign Number (If Different)	Message
D5-7		REST AREA TOURIST INFO CENTER XX MILES
D5-7A		TOURIST INFO CENTER
D5-8		REST AREA TOURIST INFO CENTER (Oblique Arrow)
D6-1		SCENIC AREA (Horizontal Arrow)
D6-2		SCENIC OVERLOOK XX MILES
D6-3		SCENIC AREA (Oblique Arrow)
D6-4		AMERICA'S BYWAYS
D6-4A		AMERICA'S BYWAYS
D7-1	D7-3 (<2002)	Three Line Rectangular Recreational Destination & Distance
D7-100		RECREATION AREA NEXT RIGHT (Symbol Template)
D7-105	D7-4 (<2002)	TRAIL of '98 (Arrow)
D7-2	D7-2A (2002)	Two Line Trapezoidal Destination & Arrow See Interim Addenda
D7-RA Plates (1/2)		RA Accommodation Service Plates page (1 of 2)
D7-RA Plates (2/2)		RA Accommodation Service Plates page (2 of 2)
D7-RG Plates (1/2)		RG General Information Plates page (1 of 2)
D7-RG Plates (2/2)		RG General Information Plates page (2 of 2)
D7-RL Plates (1/2)		RL Land Recreation Plates page (1 of 2)
D7-RL Plates (2/2)		RL Land Recreation Plates page (2 of 2)
D7-RM Plates (1/2)		RM Motorist Service Plates page (1 of 2)
D7-RM Plates (2/2)		RM Motorist Service Plates page (2 of 2)
D7-RS Plates (1/2)		RS Winter Recreation Plates page (1 of 2)
D7-RS Plates (2/2)		RS Winter Recreation Plates page (2 of 2)
D7-RW Plates (1/2)		RW Water Recreation Plates page (1 of 2)
D7-RW Plates (2/2)		RW Water Recreation Plates page (2 of 2)
D8-1		WEIGH STATION 1 MILE
D8-100	D8-2 (<2002)	WEIGH STATION RIGHT LANE
D8-101		Plaque (OPEN/CLOSED)
D8-102	D8-6C (<2002)	CUSTOMS 1 MILE
D8-103	D8-8 (<2002)	CUSTOMS 1000 FT OPEN/CUSTOMS CLOSED (hinged)
D8-104	D8-7 (<2002)	CUSTOMS (Diagonal Right Arrow)
D8-2		WEIGH STATION NEXT RIGHT
D8-3		WEIGH STATION (Diagonal Right Arrow)
D9 Plates (1/3)		General Service Plates (D9-1 to D9-5)
D9 Plates (2/3)		General Service Plates (D9-6, D9-7, D9-9 to D9-13, D9-15, D9-100)
D9 Plates (3/3)		General Service Plates (D9-101 to D9-106, D9-109)
D9-1		Telephone (Symbol)
D9-100		RV PARK
D9-103	D9-4 (<2002)	LITTER BARREL 1000 FT (Symbol)
D9-104	D9-15 (<2002)	TROOPERS (Symbol & Text Plaque)
D9-105	D9-14 (<2002)	PARKING (Symbol & Text Plaque)
D9-106	D9-13 (<2002)	WATER (Symbol & Text Plaque)
D9-107	D9-19 (<2002)	Post Office
D9-108	D9-19C (<2002)	Post Office 1 Mile
D9-13B		Ambulance Station
D9-13C		Emergency Medical Care
D9-14		Police Assistance
D9-15		Propane (Symbol)
D9-16		Truck Parking (Word Message)

Index - Sorted by Sign Number

Sign Number	Pre-2006 Sign Number (If Different)	Message
D9-18		Motor Services (Symbols) (Combination)
D9-18A		Motor Services (Word Message)
D9-1A		Telephone w/ Arrow (Symbol)
D9-1B	D9-1A (<2002)	Telephone 1/4 MILE (Symbol)
D9-1C		Emergency 911 Telephone (Symbol)
D9-2		Hospital (Symbol)
D9-201, 202, 203		FOOD, PHONE, GAS, LODGING, HOSPITAL, CAMPING (Text Signs)
D9-204		General Community Service
D9-205		Tourist Oriented Service Sign (TODS)
D9-206		WELCOME TO Community
D9-207		DAY MEDICAL CLINIC
D9-210		NEXT SERVICES 44 MILES
D9-220	D9-18 (<2002)	STATE TROOPERS (w/ Arrow)
D9-221	D9-18C (<2002)	STATE TROOPERS 1 MILE
D9-230		Public Dumpster See Interim Addenda
D9-3		Tent Camping (Symbol)
D9-301		Directional Arrow (Symbol)
D9-302		1/2 Mi. (Hor. Arrow)
D9-303		1/2 Mi. (Up Arrow)
D9-304	D9-B (<2002)	1000 FT
D9-305	D9-D (<2002)	1/2 MILE
D9-306	D9-C (<2002)	1 Mile
D9-308	D9-E (<2002)	1500 FT
D9-3X	D9-3B (<2002)	Tent Camping Prohibited (Symbol)
D9-4	D9-3A (<2002)	Trailer Camping (Symbol)
D9-4X	D9-3C (<2002)	Trailer Camping Prohibited (Symbol)
E10-11		Destination EXIT ONLY
E10-21		Destination EXIT ONLY w/ Route Marker
E1-11		Advance Route Distance (One City)
E11-1		EXIT ONLY w/ Down Arrow Plate
E1-12		Advance Route Distance (Two Cities)
E1-31		Advance City Distance (One City)
E1-32		Advance City Distance (Two Cities)
E1-5		EXIT 444
E2-1		NEXT EXIT 7 MILES (1 line)
E2-11		Destination NEXT RIGHT
E2-12		Two Destinations NEXT RIGHT
E2-1A		NEXT EXIT 7 MILES (2 lines)
E3-11		Destination (Arrow)
E3-12		Two Destinations (Arrow)
E3-21		Destination w/ Route Marker & Arrow
E3-22		Two Destinations w/ Route Marker and Arrow
E4-11		Destination (Arrow)
E4-12		Two Destinations (Arrow)
E4-21		Destination w/ Route Marker and Arrow
E4-22		Two Destinations w/ Route Marker and Arrow
E5-1		EXIT (Diagonal Right Arrow)
E5-100		CLOSED (plaque)

Index - Sorted by Sign Number

Sign Number	Pre-2006 Sign Number (If Different)	Message
E5-1A		EXIT Number (Diagonal Right Arrow)
E5-2		EXIT OPEN (plaque)
E5-2A		EXIT CLOSED (plaque)
E5-3		EXIT ONLY (plaque)
E6-2		Direction w/ Route Marker and Route Name
E8-12		Exit Mileage (Two Exits)
E8-13		Exit Mileage (Three Exits)
E9-11		Number of Exits to One City
E9-12		Number of Exits to Two Cities
EM1-100	CD-100 (<2003) AK-CD-1A (previous)	TSUNAMI EVACUATION ROUTE (Symbol)
EM-2		AREA CLOSED
EM-3		TRAFFIC CONTROL POINT
EM-4		MAINTAIN TOP SAFE SPEED
EM-5		ROAD USE PERMIT REQUIRED FOR THRU TRAFFIC
EM-6A		MEDICAL CENTER (Arrow)
EM-6B		WELFARE CENTER (Arrow)
EM-6C		REGISTRATION CENTER (Arrow)
EM-6D		DECONTAMINATION CENTER (Arrow)
EM-7A		EMERGENCY SHELTER XX MI (Arrow)
EM-7B		HURRICANE SHELTER XX MI (Arrow)
EM-7C		FALLOUT SHELTER XX MI Arrow Hazard (Symbol)
EM-7D		CHEMICAL SHELTER XX MI Arrow Hazard (Symbol)
G20-1		ROAD WORK NEXT XX MILES
G20-2	G20-2A (<2003)	END ROAD WORK
G20-4		PILOT CAR FOLLOW ME
I-1		SIGNALS SET FOR 25 MPH
I-100	I-08 (<2002)	Ferry Terminal (Symbol)
I-101		WELCOME TO [Town Name]
I-102		School (Symbol) w/ SCHOOL plaque
I-103		MUSEUM
I-11		Recycling Collection Center (Symbol)
I-111		NEXT 25 MI
I-120	D9-22B (<2002)	SLOW VEHICLES USE TURNOUTS NEXT 2 MILES
I-121	D9-22A (<2002)	SLOW VEHICLE TURNOUT (Arrow)
I-122	D9-22 (<2002)	SLOW VEHICLE TURNOUT 1000 FT
I-13		Emergency Notification
I-130		PLEASE LIMIT YOUR STAY TO 8 HOURS - NO TENTS OR CAMPS
I-131		NOTICE THIS PARKING AREA IS FOR COMMUTERS ONLY
I-13A		Emergency Notification (Alternate)
I-140		SPEEDOMETER CHECK SECTION AHEAD
I-141	I-141E was M9-3, I-141B was M9-1 (<2002)	END CHECK MILE 5/BEGIN CHECK MILE 0
I-142	M9-2 (<2002)	MILE 4
I-150		ADOPT A HIGHWAY With Sponsor Name Plate See Interim Addenda
I-151		ADOPT A BIKE PATH With Sponsor Name Plate
I-152		ADOPT A STREAM With Sponsor Name Plate

Index - Sorted by Sign Number

Sign Number	Pre-2006 Sign Number (If Different)	Message
I-160	AK-SP1-1 (<2002)	PLEASE DON'T DRINK AND DRIVE
I-161	AK-SP1-2 (<2002)	PLEASE DRIVE SAFELY
I-162	AK-SP1-3 (<2002)	IN MEMORY OF _____
I-163	AK-SP1-4 (<2002)	SPONSORED BY THE _____ FAMILY
I-164		PLEASE BUCKLE UP
I-171	I-15B (<2002)	Large SCENIC BYWAY (Symbol & Text)
I-180	M8-1 (<2002)	STATE MAINTENANCE BEGINS
I-181	M8-2 (<2002)	STATE MAINTENANCE ENDS
I-200		TOURIST INFO CENTER
I-201		TOURIST INFO KIOSK
I-2A		Town Name CITY LIMITS
I-2B		Town Name
I-2C		ENTERING [Name] Borough
I-2D		LEAVING [Name] Borough
I-2E		ENTERING [Town Name]
I-2F		ENTERING GAME MANAGEMENT UNIT
I-2G		LEAVING GAME MANAGEMENT UNIT
I-3		River Name - 2 Line
I-3B		Pass Name and Elevation - 2 Line
I-4A		Trail Name (Arrow)
I-5		Airport (Symbol)
I-6		Bus Stop (Symbol)
I-7		Train Station (Symbol)
I-8/I-8P		Library (Symbol), LIBRARY Plate
LG-F1x2		CAMPING Logo
LG-F3x1		GAS Logo
LG-F3x2		LODGING CAMPING Logo
LG-FP		NEXT RIGHT (Plaque)
LG-FP2		NEXT RIGHT (2-Lines, Plaque)
LG-R1x2		CAMPING (Arrows, Logos)
LG-R1x3		FOOD (Arrows, Logos)
M11-1		ALASKA DOT/PF THOMPSON PASS STATION
M1-2		Off-Interstate Business Loop Marker (Symbol)
M12-1		Fire Hydrant (Symbol)
M1-3		Off-Interstate Business Spur Marker (Symbol)
M1-5	M1-6 (<2003)	ALASKA Route Marker (Symbol)
M1-7		NATIONAL FOREST ROUTE MARKER
M1-9		Bike Route Marker (Symbol)
M2-1		JCT Plate
M2-2		JCT w/ 2 Route Markers
M2-2A (3)		JCT w/ 3 Route Markers
M3-1, M3-2		NORTH, EAST (Plates)
M3-3, M3-4		SOUTH, WEST (Plates)
M4-1, 1A, 2, 3		ALTERNATE, ALT, BYPASS, BUSINESS (Plates)
M4-10		DETOUR (Horizontal Arrow)
M4-100, 101, 102		BEGIN, END, TO (Plates)
M4-103	M4-9A (<2003)	DETOUR (Vertical Arrow)
M4-4, 5, 6		TRUCK, TO, END (Plates)

Index - Sorted by Sign Number

Sign Number	Pre-2006 Sign Number (If Different)	Message
M4-7		TEMPORARY (Plate)
M4-8		DETOUR (Plate)
M4-8A		END DETOUR
M4-9		DETOUR (Horizontal Arrow)
M4-9A		PEDESTRIAN BIKE DETOUR (Symbols, Arrow)
M4-9B		PEDESTRIAN DETOUR (Symbol, Arrow)
M4-9C		BIKE DETOUR (Symbol, Arrow)
M5-1, 2		Arrow (90 degree & 45 degree)
M6-1, 2		Arrow (Horizontal and 45 degree)
M6-3,4		Arrow (Vertical & Left-Right)
M6-5, 6		Arrow (2 direction 45 degree and 90 degree)
M6-7		Arrow (Up and Diagonal Right)
M6-8		Arrow (Up & Right)
M6-9		Arrow (Left and Right)
M7-1, 2, 3		Bike Arrow (Right, Up, and Diagonal)
M7-4, 5, 6, 7		Bike Arrow (Diagonal, and Three 2 Directions)
OM1-1, 2, 3		Object Marker (Type 1) See Interim Addenda
OM2-1V, 2V, 1H, 2H		Object Marker (Type 2)
OM-3L, 3C, 3R		Object Marker (Type 3)
OM4-1, 2, 3		Object Marker (Type 4) See Interim Addenda
R10-1		CROSS ON GREEN LIGHT ONLY
R10-10		LEFT (or Right) TURN SIGNAL
R10-100	R10-13 (<2002)	Left Turn (Arrow) ONLY YIELD ON GREEN Ball (Symbol)
R10-11A		NO TURN ON RED (Rectangle)
R10-11B		NO TURN ON RED (Square)
R10-11C		No Right Turn ON RED (Symbol)
R10-11D		No Left Turn ON RED (Symbol)
R10-12		LEFT TURN YIELD ON GREEN Ball (Symbol)
R10-13		EMERGENCY SIGNAL
R10-15		TURNING TRAFFIC MUST YIELD TO PEDESTRIANS
R10-16		U-TURN YIELD TO RIGHT TURN
R10-2		CROSS ON WALK SIGNAL ONLY
R10-20a		MON-FRI, Hours (Three line), (Two line)
R10-22		TO REQUEST GREEN WAIT ON Bicycle (Symbol)
R10-2A		CROSS ONLY ON Walk (Symbol) SIGNAL
R10-3A		TO CROSS (Arrow) STREET PUSH BUTTON WAIT FOR GREEN LIGHT
R10-3B		Meaning of Ped Signals
R10-3C		Educational plaque for pedestrian signals
R10-3D		Educational plaque for pedestrian signals (To Median)
R10-3E		Educational plaque for pedestrian signal (Countdown)
R10-4A		TO CROSS STREET (Arrow) PUSH BUTTON WAIT FOR WALK SIGNAL
R10-4B		PUSH BUTTON FOR Walk (Symbol)
R10-5	R10-5A (<2002)	LEFT ON GREEN ARROW ONLY
R10-6		STOP HERE ON RED (Arrow), (Left and Right)
R10-7		DO NOT BLOCK INTERSECTION
R10-8		USE LANE WITH GREEN ARROW

Index - Sorted by Sign Number

Sign Number	Pre-2006 Sign Number (If Different)	Message
R1-1		STOP
R1-100		TO VEHICLES IN CIRCLE (Plaque)
R11-1		KEEP OFF MEDIAN
R11-100	R11-5 (<2002)	NO ROAD MAINTENANCE AFTER NOV 1
R11-101	R11-6 (<2002)	ROAD CLOSED AVALANCHE AREA
R11-102		LANE CLOSED
R11-2		ROAD CLOSED
R11-3	R11-3A (<2002)	ROAD CLOSED 10 MILES AHEAD LOCAL TRAFFIC ONLY
R11-3A	R11-3B (<2002)	BRIDGE OUT 10 MILES AHEAD LOCAL TRAFFIC ONLY
R11-4		ROAD CLOSED TO THRU TRAFFIC
R1-2		YIELD
R12-1		WEIGHT LIMIT 10 TONS
R12-100	R12-5A (<2002)	WEIGHT LIMIT TANDEM GROUP 16K LBS
R12-101	R12-5B (<2002)	WEIGHT LIMITS AXLE 16K LBS TANDEM GROUP 28K LBS
R12-102	R12-6 (<2002)	LEGAL LIMIT 75% OF MAXIMUM AXLE LOAD
R12-103	R12-7 (<2002)	NO STUDDED TIRES (Dates)
R12-104	R12-8 (<2002)	CHAINS REQUIRED AHEAD
R12-105	R12-9 (<2002)	CHAINS REQUIRED ON ALL VEHICLES
R12-106	R12-10 (<2002)	INSTALL CHAINS HERE (Arrow)
R12-107	R12-11 (<2002)	END CHAIN AREA
R12-108		STUDS OR CHAINS REQUIRED NEXT 3 MILES
R12-112		NO OFF ROAD VEHICLES ON ROAD OR WITHIN 3 FT
R12-2		AXLE WEIGHT LIMIT 5 TONS
R12-3		NO TRUCKS OVER 7K LBS EMPTY WT
R12-4		WEIGHT LIMIT 2 TONS PER AXLE 10 TONS GROSS
R12-5		WEIGHT LIMIT 8T 12T 16T (Symbol)
R1-2A		TO ONCOMING TRAFFIC
R1-3		Four-WAY
R13-1		ALL TRUCKS COMMERCIAL VEHICLES NEXT RIGHT
R13-100		TRUCKS OVER 16,000 GVWR STOP AT SCALES WHEN OPEN
R13-101		WEIGH STATION CLOSED/TRUCKS STOP AT SCALES
R13-102		WEIGH STATION CLOSED/TRUCKS OVER 16,000 GVWR STOP AT SCALES
R13-103	R13-2 (<2002)	ALL VEHICLES STOP AT CUSTOMS
R1-4		ALL WAY
R14-1		TRUCK ROUTE
R14-1A		TRUCK ROUTE (Arrow)
R14-2		HM Hazardous Material (Symbol)
R14-3		Hazardous Material Prohibited (Symbol)
R15-1		RAILROAD CROSSING (Cross Bucks)
R15-2		Three TRACKS
R15-3		EXEMPT
R15-8		LOOK (Arrows)
R1-5AL		YIELD HERE TO PEDESTRIANS (Left) (Symbol)
R1-5AR		YIELD HERE TO PEDESTRIANS (Right) (Symbol)
R1-5L		Yield Here To Pedestrians (Left) with Ped (Symbol)
R1-5R		Yield Here To Pedestrians (Right) with Ped (Symbol)
R1-6		In-Street Pedestrian Crossing (Yield) (Symbol)

Index - Sorted by Sign Number

Sign Number	Pre-2006 Sign Number (If Different)	Message
R16-1		BUCKLE UP IT'S THE LAW (Symbol)
R16-100	AK-CR16-100 (<2002)	WORK ZONE BEGIN DOUBLE TRAFFIC FINES
R16-101	AK-CR16-101 (<2002)	END DOUBLE TRAFFIC FINES
R16-102	AK-CR16-102 (<2002)	DOUBLE FINES WHERE POSTED (w/ Inset Sign)
R16-103		DELAY OF 5 VEHICLES ILLEGAL MUST USE TURNOUTS
R16-104	R16-2	NO SHOOTING FROM ROADWAY
R16-105	R16-3	NO SHOOTING WITHIN 1/4 MILE OF ROADWAY
R16-106	R16-1	FINE FOR LITTERING \$1000
R16-107		KEEP OFF WET PAINT
R16-108		NO FISHING FROM BRIDGE
R16-109		DUMPING PROHIBITED
R16-110		DRIVE WITH HEADLIGHTS ON AT ALL TIMES See Interim Addenda
R16-111		STOP - FOLLOW PILOT CAR WHEN GOING YOUR WAY
R16-112		BEGIN HIGHWAY SAFETY ZONE TRAFFIC FINES DOUBLE
R16-113		SAFETY ZONE BEGIN DOUBLE TRAFFIC FINES
R16-114		DOUBLE FINES
R16-115		BUSES & HAZMAT VEHICLES USE RIGHT LANE
R2-1		SPEED LIMIT 50
R2-100	AK-CR2-100 (<2002)	WORKZONE SPEED LIMIT 45 DOUBLE FINES
R2-101		SAFETY ZONE SPEED LIMIT 45 DOUBLE FINES (Yellow)
R2-2		TRUCKS 40
R2-4		MINIMUM SPEED 40
R2-5A		REDUCED SPEED AHEAD
R2-5C		SPEED ZONE AHEAD
R3-1		No Right Turn (Symbol)
R3-100		EMERGENCY VEHICLES EXEMPT (Plaque)
R3-101	R3-17 (<2006)	RIGHT LANE Bikes ONLY (Symbol)
R3-10A		BUS LANE AHEAD
R3-16		Bike LANE AHEAD (Symbol)
R3-16A		Bike LANE ENDS (Symbol)
R3-18		Combination U-Turn & Left Turn Prohibition (Symbol)
R3-1A		NO RIGHT TURN ACROSS TRACKS
R3-2		No Left Turn (Symbol)
R3-2A		NO LEFT TURN ACROSS TRACKS
R3-3		NO TURNS
R3-4		No U-Turn (Symbol)
R3-4A		U and Left Turn (Arrows)
R3-4B		U and 2 Left Turn (Arrows)
R3-5		Right/Left Turn ONLY (Arrow)
R3-5A		Straight ONLY (Arrow)
R3-5B		LEFT LANE (Plaque)
R3-5C		High Occupancy Vehicle (HOV) 2+ (Plaque)
R3-5D		TAXI LANE (Plaque)
R3-5E		CENTER LANE (Plaque)
R3-5F		RIGHT LANE (Plaque)
R3-5G		BUS LANE (Plaque)
R3-6	R3-6SL (<2002)	Left Turn/Straight Movement ONLY (Arrows)
R3-7		LEFT/RIGHT LANE MUST TURN LEFT/RIGHT
R3-8		Lane use control Options

Index - Sorted by Sign Number

Sign Number	Pre-2006 Sign Number (If Different)	Message
R3-8 L/LR	R3-8L/DT (<2002)	Lane Use Control-Multiple Lanes (Arrow)
R3-8 L/S		Lane Use Control - Multiple Lanes (Arrow)
R3-8 L/SL		Lane Use Control - Multiple Lanes (Arrow)
R3-9A		Arrows - Two Way Left Turn Only
R3-9B		CENTER LANE TWLTL ONLY (Arrows)
R3-9D		Reversible Lane Control Signs
R3-9F		Reversible Lane Control Signs
R3-9G		Reversible Lane Control Signs
R3-9H		Reversible Lane Control Signs
R3-9I		Reversible Lane Control Signs
R4-1		DO NOT PASS
R4-10		RUNAWAY VEHICLES ONLY
R4-100		KEEP RIGHT EXCEPT TO PASS
R4-2		PASS WITH CARE
R4-3	SLOWER TRAFFIC KEEP RIGHT	
R4-4	BEGIN RIGHT TURN LANE YIELD TO BIKES (Arrow)	
R4-5	TRUCKS USE RIGHT LANE	
R4-6	TRUCK LANE 500 FEET	
R4-6A	PASSING LANE 2 MILES	
R4-6B	NEXT PASSING LANE 2 MILES	
R4-7	Keep Right (Symbol)	
R4-7A	KEEP RIGHT (Hor. Arrow)	
R4-7B	KEEP RIGHT (45 deg. Arrow)	
R4-8	Keep Left (Arrow and Symbol)	
R4-9	STAY IN LANE	
R5-1	DO NOT ENTER (Symbol)	
R5-100	R5-5A (<2002)	STUDED TIRES PROHIBITED
R5-10A		PEDESTRIANS BICYCLES MOTOR DRIVEN CYCLES PROHIBITED
R5-10B		PEDESTRIANS AND BICYCLES PROHIBITED
R5-10C		PEDESTRIANS PROHIBITED
R5-1A		WRONG WAY
R5-1B		WRONG WAY Bicycle (Symbol)
R5-2		No Trucks (Symbol)
R5-3		NO MOTOR VEHICLES
R5-3A, R5-3AP		NO MOTOR VEHICLES (Narrow), PATHWAY (Plate)
R5-4		COMMERCIAL VEHICLES EXCLUDED
R5-5		VEHICLES WITH LUGS PROHIBITED
R5-6		Bicycles Prohibited (Symbol)
R5-7		NON-MOTORIZED TRAFFIC PROHIBITED
R5-8		MOTOR-DRIVEN CYCLES PROHIBITED
R6-1	ONE WAY (Left/Right Arrow)	
R6-2	ONE WAY (Left/Right Arrow)	
R6-3	DIVIDED HIGHWAY (4-Leg Intersection)	
R6-3A	DIVIDED HIGHWAY (T-Intersection)	
R7 Pg 1	No Parking/Stopping Legend Options for R7S & R7P	
R7 Pg 2	No Parking/Stopping Legend Options for R7S & R7P	
R7 Pg 3	No Parking/Stopping Legend Options for R7S & R7P	
R7 Pg 4	No Parking/Stopping Legend Options for R7S & R7P	

Index - Sorted by Sign Number

Sign Number	Pre-2006 Sign Number (If Different)	Message
R7-107A		No Parking (Symbol) BUS STOP
R7-108	R7-108B (<2002)	Two HR PARKING (Arrow) 8:30 am - 5:30 pm
R7-111		PARALLEL PARKING ONLY
R7-112		DIAGONAL PARKING ONLY
R7-200		NO PARKING ANY TIME (Left), ONE HOUR PARKING (Right)
R7-201, 201A, 201B	R7-201, R7-201A, R7-202 (<2002)	TOW-AWAY ZONE, Tow-Away Zone (Symbol), THIS SIDE OF SIGN
R7-202	R7-202K&M (<2002)	BEGIN, END plates
R7-203		EMERGENCY SNOW ROUTE NO PARKING IF OVER XX INCHES
R7-300		UNLESS YOU NEED VAN ACCESS PLEASE USE OTHER ACCESSIBLE SPACES FIRST
R7-8		RESERVED PARKING HANDICAPPED (Symbol)
R7-8A		VAN ACCESSIBLE
R7-9		NO PARKING BIKE LANE
R7-9A		No Parking (Symbol) BIKE LANE
R7P-	R7- (<2002)	NO PARKING sign blank
R7S-		NO STOPPING sign blank
R8-1		NO PARKING ON PAVEMENT
R8-10		STOP HERE WHEN FLASHING (Arrow)
R8-100		NO PARKING BEYOND THIS POINT
R8-101		MAXIMUM PARKING 48 HRS
R8-1A		OR WITHIN 8 FEET
R8-2		NO PARKING EXCEPT ON SHOULDER
R8-3		NO PARKING
R8-3A		No Parking (Symbol)
R8-3AP	R8-30 (<2002)	Plaque for R8-3a, Seven Message Options
R8-3C		ON PAVEMENT (Supplemental Plaque)
R8-3D		ON BRIDGE (Supplemental Plaque)
R8-4		EMERGENCY PARKING ONLY
R8-5		NO STOPPING ON PAVEMENT
R8-6		NO STOPPING EXCEPT ON SHOULDER
R8-7		EMERGENCY STOPPING ONLY
R8-8		DO NOT STOP ON TRACKS
R8-9		TRACKS OUT OF SERVICE
R9-1		WALK ON LEFT FACING TRAFFIC
R9-10		SIDEWALK CLOSED USE OTHER SIDE (Arrow)
R9-100		PEDESTRIANS (Arrow)
R9-101		Multi-Use (Symbol) PATHWAY
R9-11		SIDEWALK CLOSED AHEAD CROSS HERE (Arrow)
R9-11A		SIDEWALK CLOSED CROSS HERE (Arrow)
R9-2		CROSS ONLY AT CROSSWALKS
R9-3		NO PEDESTRIAN CROSSING
R9-3A		No Pedestrians (Symbol)
R9-3B		USE CROSSWALK (Arrow)
R9-3C		RIDE WITH TRAFFIC
R9-4		NO HITCH HIKING
R9-5		Bikes USE PED SIGNAL (Symbol)
R9-6		Bikes YIELD TO PEDS (Symbol)

Index - Sorted by Sign Number

Sign Number	Pre-2006 Sign Number (If Different)	Message
R9-7		KEEP LEFT Peds/RIGHT Bikes (Symbol)
R9-8		PEDESTRIAN CROSSWALK
R9-9		SIDEWALK CLOSED
S1-1		Advance School Crossing (Symbol)
S3-1		SCHOOL BUS STOP AHEAD
S4-1		8:30 AM TO 5:30 PM
S4-2		WHEN CHILDREN ARE PRESENT (3 lines)
S4-3		SCHOOL
S4-4		WHEN FLASHING
S4-5		Reduced Speed (School) Zone Ahead MPH (symbol)
S4-5A		20 MPH SCHOOL ZONE AHEAD
S4-6		MON-FRI
S5-1		SCHOOL SPEED LIMIT 20 MPH WHEN FLASHING
S5-2		END SCHOOL ZONE
S5-2A	S6-1 (<2002)	END SCHOOL ZONE (Plaque)
S6-1		DRUG-FREE SCHOOL ZONE
W10-1		Railroad Advance Crossing (Symbol)
W10-10		NO SIGNAL
W10-100	W10-5A (<2002)	BICYCLES USE CAUTION - RR Crossing (Symbol)
W10-11		Tracks Near Intersection (symbol)
W10-11A		XX FT BETWEEN TRACKS & HIGHWAY
W10-11B		XX FT BETWEEN TRACKS & HIGHWAY BEHIND YOU
W10-12		Skewed Crossing (symbol)
W10-13		NO GATES OR LIGHTS
W10-14		NEXT CROSSING
W10-14A		USE NEXT CROSSING
W10-15		ROUGH CROSSING
W10-2	W10-4 (<2002)	Railroad Crossing Advance of Road Intersection (Symbol)
W10-3		Railroad Crossing Advance Intersecting Road (Right) (Symbol)
W10-4		Railroad Crossing At T Intersection - 90 degrees to Main Road (Symbol)
W10-5		Rail-Highway Low Ground Clearance (Symbol)
W10-9		NO TRAIN HORN
W1-1		Turn Arrow 90 Degree (Symbol) (Left and Right)
W1-10		Curve with Intersection Advisory (Arrow) (Symbol)
W1-100	W1-9 (<2002)	Turn Arrow 180 Degree (Symbol)
W1-101	W1-10 (<2002)	Turn Arrow 360 Degree (Symbol)
W11-1		Bike Crossing (Symbol)
W11-10		Truck Crossing (Symbol)
W11-100	W11-6 (<2002)	Snowmobile Crossing (Symbol)
W11-101	W11-7 (<2002)	Equestrian Crossing (Symbol)
W11-103	W11-12 (<2002)	Moose Crossing (Symbol)
W11-104	W11-13 (<2002)	Caribou Crossing (Symbol)
W11-105	W11-14 (<2002)	Bison Crossing (Symbol)
W11-107	W11-20 (<2002)	LOOSE LIVESTOCK
W11-108		DOG TEAM CROSSING
W11-11		Golf Cart Crossing (Symbol)
W11-12P		EMERGENCY SIGNAL AHEAD
W11-14		Horse and Buggy Crossing (Symbol)

Index - Sorted by Sign Number

Sign Number	Pre-2006 Sign Number (If Different)	Message
W11-2		Advance Ped Crossing - Use with W16-07 (Symbol)
W1-13		Truck Rollover (Symbol)
W11-3		Deer Crossing (Symbol)
W11-4		Cattle Crossing (Symbol)
W11-5		Farm Machinery Crossing (Symbol)
W11-7	W11-11 (<2002)	Horse Crossing (Symbol)
W11-8		Fire Truck (Symbol)
W11-8A		FIRE STATION
W11-9		Handicap Crossing (Symbol)
W1-1A		Turn (Symbol) w/ advisory speed (Left and Right)
W1-2		Curve (Arrow) (Symbol) (Left and Right)
W12-1		Left/Right Down Arrows (Symbol)
W12-100	W12-2B (<2002)	4 MI AHEAD (Plaque)
W12-101	W12-4 (<2002)	10 TON WEIGHT LIMIT
W12-2		LOW CLEARANCE SYMBOL (Two Arrows)
W12-2A		LOW CLEARANCE SYMBOL (One Arrow)
W12-2P	CW12-2C (<2002)	14 FT 10 INCHES - Low Clearance Plate
W1-2A		Curve (Symbol) w/ advisory speed (Left and Right)
W1-3		Reverse Turn (Arrow) (Symbol)
W13-1		35 MPH (Advisory Speed Plate)
W13-1A		NEXT 25 MILES (Advisory Plate)
W13-2		EXIT 25 MPH (Advisory Speed Plate)
W13-3		RAMP 30 MPH (Advisory Speed Plate)
W1-4		Reverse Curve (Arrow) (Symbol)
W14-1		DEAD END
W14-100	W14-2A (<2002)	END
W14-101	W14-2B (<2002)	END ROAD 1000 FT
W14-102	W14-2C (<2002)	END MAINTENANCE 1500 FT
W14-103	W14-5A (<2002)	ROAD CLOSED AHEAD
W14-104	W14-5B (<2002)	BRIDGE CLOSED AHEAD
W14-105		TRAVEL BEYOND THIS POINT...
W14-1P		DEAD END w/ Arrow (Plate)
W14-2		NO OUTLET
W14-2D		NO TURNAROUND
W14-2P		NO OUTLET w/ Arrow (Plate)
W14-3		NO PASSING ZONE
W1-5		Winding Road (Arrow) (Symbol)
W15-1		Playground (symbol)
W1-6		One Way (large Arrow) (Symbol)
W16-1		SHARE THE ROAD
W16-100	W16-1 (<2002)	SLIDE AREA
W16-101	W16-2 (<2002)	END SLIDE AREA
W16-102	W16-3 ICY (<2002)	WATCH FOR ICE
W16-103	Replaced W16-4 and W16-14	WATER OVER ROADWAY
W16-104	W16-7 (<2002)	WIND AREA
W16-105	W16-8 (<2002)	ROCKS
W16-106	W16-9 AIRCRAFT (<2002)	AIRCRAFT CROSSING

Index - Sorted by Sign Number

Sign Number	Pre-2006 Sign Number (If Different)	Message
W16-107	W16-10 (<2002)	END OF FREEWAY 1/2 MI
W16-108	W16-12 (<2002)	JETBLAST AREA
W16-109	W16-13 (<2002)	END JETBLAST AREA
W16-110	W16-5 (<2002)	AVALANCHE AREA
W16-111	W16-6 (<2002)	END AVALANCHE AREA
W16-112		AVALANCHE AREA NEXT 2 MI DO NOT STOP
W16-113		PRIMITIVE ROAD NO WARNING SIGNS
W16-114		LOW FLYING AIRCRAFT
W16-13		WHEN FLASHING
W16-2P		500 FT
W16-3		XX MILES (2 lines)
W16-3A		XX MILES (1 line)
W16-4		NEXT 500 FT
W16-5P		Right, Left Arrow (Plaque)
W16-6P		Right Turn, Left Turn Arrow (Plaque)
W16-7P		Diagonal Arrow (Left/Right) (Plaque)
W16-8A		Advance Street Name (2-line Plaque) (Arrows)
W16-8P		Advance Street Name (Plate)
W16-9P		AHEAD
W1-7		Two Way (large Arrow) (Symbol)
W17-1		SPEED HUMP
W1-8		Chevron (Symbol)
W2-1		Four-Way Intersection (Symbol)
W2-2		Side Road (90 Degree) (Symbol)
W2-3		Side Road (45 Degree) (Symbol)
W2-4		Intersection T (Symbol)
W2-5		Intersection Y (Symbol)
W25-1		ONCOMING TRAFFIC HAS EXTENDED GREEN
W25-2		ONCOMING TRAFFIC MAY HAVE EXTENDED GREEN
W2-6		Roundabout Ahead (Symbol)
W2-6A		ROUNDBOUT (Plaque)
W3-100		NEW TRAFFIC PATTERN
W3-1A	W3-1 (<2002)	Stop Ahead (Symbol)
W3-2	W3-2A (<2006), W3-2 (<2002)	Yield Ahead (Symbol)
W3-3		Signal Ahead (Symbol)
W3-6		DRAW BRIDGE AHEAD
W4-1		Merge (Arrow) (Symbol)
W4-2		Lane Ends (Symbol)
W4-3		Added Lane, One Through Lane (Arrow) (Symbol)
W4-4A		TRAFFIC FROM LEFT DOES NOT STOP
W4-4B		ONCOMING TRAFFIC DOES NOT STOP
W4-4P		CROSS TRAFFIC DOES NOT STOP
W4-5		Entering Roadway Merge (Symbol)
W4-6		Entering Roadway Added Lane (Symbol)
W5-1		ROAD NARROWS
W5-1A		SHOULDER NARROWS
W5-2		NARROW BRIDGE
W5-3		ONE LANE BRIDGE

Index - Sorted by Sign Number

Sign Number	Pre-2006 Sign Number (If Different)	Message
W5-4		RAMP NARROWS
W5-4A		BIKEWAY NARROWS
W6-1		Divided Highway Begins (Arrows) (Symbol)
W6-100	W6-4(1-2) (<2002)	One Lane Opposing Two Lanes (Arrows) (Symbol)
W6-2		Divided Highway Ends (Arrows) (Symbol)
W6-3		Two Way Traffic (Arrows) (Symbol)
W7-1		Truck on Hill (Symbol)
W7-100	W7-6 (<2002)	SLOW MOVING VEHICLES
W7-101		HILL BLOCKS VIEW
W7-102		HIDDEN DRIVEWAY
W7-1A		Truck On Hill 9% Slope (Symbol)
W7-2B	W7-2 (<2002)	TRUCKS USE LOWER GEAR
W7-3		9% GRADE
W7-3A		NEXT 7 MILES
W7-3B		9% GRADE NEXT 7 MILES
W7-4		RUNAWAY TRUCK RAMP X MILE
W7-4B	W7-4A (<2002)	RUNAWAY TRUCK RAMP (w/ Arrow)
W7-4C		TRUCK ESCAPE RAMP
W7-4D/E/F		SAND/GRAVEL/PAVED (Plaques)
W7-5		Hill (Bike) (Symbol)
W8-1		BUMP
W8-10		SLIPPERY WHEN WET (Bike Symbol)
W8-10A		SLIPPERY WHEN WET (Plaque)
W8-12		NO CENTER STRIPE
W8-1A		BUMPS
W8-2		DIP
W8-2A		DIPS
W8-3		PAVEMENT ENDS
W8-4		SOFT SHOULDER
W8-5		Slippery When Wet (Symbol)
W8-5P		SLIPPERY WHEN WET (Plate)
W8-6		TRUCK CROSSING
W8-9		LOW SHOULDER
W8-9A		SHOULDER DROP-OFF
W9-1		RIGHT (LEFT) LANE ENDS
W9-2		LANE ENDS MERGE LEFT (RIGHT)

INDEX BY SIGN MESSAGE

Im-1 to Im-16

Index - Sorted by Sign Message

Sign Number	Pre-2006 Sign Number (If Different)	Message
D9-306	D9-C (<2002)	1 Mile
D9-302		1/2 Mi. (Hor. Arrow)
D9-303		1/2 Mi. (Up Arrow)
D9-305	D9-D (<2002)	1/2 MILE
D5-103		1/4 MILE
W12-101	W12-4 (<2002)	10 TON WEIGHT LIMIT
D9-304	D9-B (<2002)	1000 FT
W12-2P	CW12-2C (<2002)	14 FT 10 INCHES - Low Clearance Plate
D9-308	D9-E (<2002)	1500 FT
S4-5A		20 MPH SCHOOL ZONE AHEAD
CW13-1		35 MPH (Advisory Speed Plate)
W13-1		35 MPH (Advisory Speed Plate)
W12-100	W12-2B (<2002)	4 MI AHEAD (Plaque)
W16-2P		500 FT
D12-5		511 TRAVEL INFO
S4-1		8:30 AM TO 5:30 PM
W7-3		9% GRADE
W7-3B		9% GRADE NEXT 7 MILES
CW4-3		Added Lane (Single Through Lane) (Symbol)
W4-3		Added Lane, One Through Lane (Arrow) (Symbol)
I-151		ADOPT A BIKE PATH With Sponsor Name Plate
I-150		ADOPT A HIGHWAY With Sponsor Name Plate See Interim Addenda
I-152		ADOPT A STREAM With Sponsor Name Plate
E1-31		Advance City Distance (One City)
E1-32		Advance City Distance (Two Cities)
W11-2		Advance Ped Crossing - Use with W16-07 (Symbol)
E1-11		Advance Route Distance (One City)
E1-12		Advance Route Distance (Two Cities)
S1-1		Advance School Crossing (Symbol)
W16-8A		Advance Street Name (2-line Plaque) (Arrows)
D3-2		Advance Street Name (Arrow in one direction)
W16-8P		Advance Street Name (Plate)
D3-2B		Advance Street Name, 2 Lines, 2 Arrows, opposite directions
W16-9P		AHEAD
W16-106	W16-9 AIRCRAFT (<2002)	AIRCRAFT CROSSING
I-5		Airport (Symbol)
M11-1		ALASKA DOT/PF THOMPSON PASS STATION
M1-5	M1-6 (<2003)	ALASKA Route Marker (Symbol)
R13-1		ALL TRUCKS COMMERCIAL VEHICLES NEXT RIGHT
R13-103	R13-2 (<2002)	ALL VEHICLES STOP AT CUSTOMS
R1-4		ALL WAY
M4-1, 1A, 2, 3		ALTERNATE, ALT, BYPASS, BUSINESS (Plates)
D9-13B		Ambulance Station
D6-4		AMERICA'S BYWAYS
D6-4A		AMERICA'S BYWAYS
EM-2		AREA CLOSED
M6-5, 6		Arrow (2 direction 45 degree and 90 degree)
M5-1, 2		Arrow (90 degree & 45 degree)

Index - Sorted by Sign Message

Sign Number	Pre-2006 Sign Number (If Different)	Message
M6-1, 2		Arrow (Horizontal and 45 degree)
M6-9		Arrow (Left and Right)
M6-8		Arrow (Up & Right)
M6-7		Arrow (Up and Diagonal Right)
M6-3,4		Arrow (Vertical & Left-Right)
CW1-1		Arrow 90 Degree (Symbol)
CW1-3		Arrow 90 Degree (Symbol)
R3-9A		Arrows - Two Way Left Turn Only
W16-110	W16-5 (<2002)	AVALANCHE AREA
W16-112		AVALANCHE AREA NEXT 2 MI DO NOT STOP
R12-2		AXLE WEIGHT LIMIT 5 TONS
CW20-7B	CW20-8 (<2003)	BE PREPARED TO STOP See Interim Addenda
R16-112		BEGIN HIGHWAY SAFETY ZONE TRAFFIC FINES DOUBLE
R4-4		BEGIN RIGHT TURN LANE YIELD TO BIKES (Arrow)
R7-202	R7-202K&M (<2002)	BEGIN, END plates
M4-100, 101, 102		BEGIN, END, TO (Plates)
R5-6		Bicycles Prohibited (Symbol)
W10-100	W10-5A (<2002)	BICYCLES USE CAUTION - RR Crossing (Symbol)
M7-4, 5, 6, 7		Bike Arrow (Diagonal, and Three 2 Directions)
M7-1, 2, 3		Bike Arrow (Right, Up, and Diagonal)
W11-1		Bike Crossing (Symbol)
M4-9C		BIKE DETOUR (Symbol, Arrow)
R3-16		Bike LANE AHEAD (Symbol)
R3-16A		Bike LANE ENDS (Symbol)
D11-1		BIKE ROUTE (w/ Symbol)
M1-9		Bike Route Marker (Symbol)
R9-5		Bikes USE PED SIGNAL (Symbol)
R9-6		Bikes YIELD TO PEDS (Symbol)
W5-4A		BIKEWAY NARROWS
W11-105	W11-14 (<2002)	Bison Crossing (Symbol)
CW22-1		BLASTING ZONE AHEAD See Interim Addenda
W14-104	W14-5B (<2002)	BRIDGE CLOSED AHEAD
R11-3A	R11-3B (<2002)	BRIDGE OUT 10 MILES AHEAD LOCAL TRAFFIC ONLY
R16-1		BUCKLE UP IT'S THE LAW (Symbol)
CW8-1		BUMP
W8-1		BUMP
CW8-1A		BUMPS
W8-1A		BUMPS
R3-5G		BUS LANE (Plaque)
R3-10A		BUS LANE AHEAD
I-6		Bus Stop (Symbol)
R16-115		BUSES & HAZMAT VEHICLES USE RIGHT LANE
LG-R1x2		CAMPING (Arrows, Logos)
LG-F1x2		CAMPING Logo
W11-104	W11-13 (<2002)	Caribou Crossing (Symbol)
D12-101	D12-2 (<2002)	CARPOOL INFO 345-POOL
D12-102		CARPOOL INFO 345-POOL (Symbol)
W11-4		Cattle Crossing (Symbol)

Index - Sorted by Sign Message

Sign Number	Pre-2006 Sign Number (If Different)	Message
CW11-101		CAUTION SNOW REMOVAL EQUIPMENT MAY BE IN YOUR LANE
CW11-100		CAUTION SNOW REMOVAL EQUIPMENT ON ROAD NEXT XX MILES
R3-5E		CENTER LANE (Plaque)
CW20-5B		CENTER LANE CLOSED See Interim Addenda
CW9-3		CENTER LANE CLOSED AHEAD (LEFT, RIGHT) See Interim Addenda
R3-9B		CENTER LANE TWLTL ONLY (Arrows)
R12-104	R12-8 (<2002)	CHAINS REQUIRED AHEAD
R12-105	R12-9 (<2002)	CHAINS REQUIRED ON ALL VEHICLES
EM-7D		CHEMICAL SHELTER XX MI Arrow Hazard (Symbol)
CW1-8		Chevron (Symbol)
W1-8		Chevron (Symbol)
E5-100		CLOSED (plaque)
R3-18		Combination U-Turn & Left Turn Prohibition (Symbol)
R5-4		COMMERCIAL VEHICLES EXCLUDED
R10-1		CROSS ON GREEN LIGHT ONLY
R10-2		CROSS ON WALK SIGNAL ONLY
R9-2		CROSS ONLY AT CROSSWALKS
R10-2A		CROSS ONLY ON Walk (Symbol) SIGNAL
W4-4P		CROSS TRAFFIC DOES NOT STOP
W1-2		Curve (Arrow) (Symbol) (Left and Right)
CW1-2		Curve (Symbol)
W1-2A		Curve (Symbol) w/ advisory speed (Left and Right)
W1-10		Curve with Intersection Advisory (Arrow) (Symbol)
D8-104	D8-7 (<2002)	CUSTOMS (Diagonal Right Arrow)
D8-102	D8-6C (<2002)	CUSTOMS 1 MILE
D8-103	D8-8 (<2002)	CUSTOMS 1000 FT OPEN/CUSTOMS CLOSED (hinged)
D9-207		DAY MEDICAL CLINIC
W14-1		DEAD END
W14-1P		DEAD END w/ Arrow (Plate)
EM-6D		DECONTAMINATION CENTER (Arrow)
W11-3		Deer Crossing (Symbol)
R16-103		DELAY OF 5 VEHICLES ILLEGAL MUST USE TURNOUTS
E3-11		Destination (Arrow)
E4-11		Destination (Arrow)
E10-11		Destination EXIT ONLY
E10-21		Destination EXIT ONLY w/ Route Marker
E2-11		Destination NEXT RIGHT
E3-21		Destination w/ Route Marker & Arrow
E4-21		Destination w/ Route Marker and Arrow
M4-9		DETOUR (Horizontal Arrow)
M4-10		DETOUR (Horizontal Arrow)
M4-8		DETOUR (Plate)
M4-103	M4-9A (<2003)	DETOUR (Vertical Arrow)
CW20-101	CW21-2 (<200)	DETOUR AHEAD See Interim Addenda
W16-7P		Diagonal Arrow (Left/Right) (Plaque)
R7-112		DIAGONAL PARKING ONLY
CW8-2		DIP

Index - Sorted by Sign Message

Sign Number	Pre-2006 Sign Number (If Different)	Message
W8-2		DIP
CW8-2A		DIPS
W8-2A		DIPS
E6-2		Direction w/ Route Marker and Route Name
D9-301		Directional Arrow (Symbol)
R6-3		DIVIDED HIGHWAY (4-Leg Intersection)
R6-3A		DIVIDED HIGHWAY (T-Intersection)
W6-1		Divided Highway Begins (Arrows) (Symbol)
CW6-1		Divided Highway Begins (Symbol)
W6-2		Divided Highway Ends (Arrows) (Symbol)
CW6-2		Divided Highway Ends (Symbol)
R10-7		DO NOT BLOCK INTERSECTION
R5-1		DO NOT ENTER (Symbol)
R4-1		DO NOT PASS
R8-8		DO NOT STOP ON TRACKS
W11-108		DOG TEAM CROSSING
CW20-102	AK-CW20-100 (<2003)	DOUBLE FINES
R16-114		DOUBLE FINES
R16-102	AK-CR16-102 (<2002)	DOUBLE FINES WHERE POSTED (w/ Inset Sign)
CW24-1		Double Reverse Curve (1-lane) (Left, Right) (Symbol)
CW24-1A		Double Reverse Curve (2-lane) (Left, Right) (Symbol)
CW24-1B		Double Reverse Curve (3-lane) (Left, Right) (Symbol)
D10-101A, 102A, 103A, 104A		Double-Faced 1, 2, 3, and 4 digit Mile Marker Intermediate Reference Location Signs
D10-101, 102, 103, 104		Double-Faced 1, 2, 3, and 4 digit Mile Marker Signs
W3-6		DRAW BRIDGE AHEAD
R16-110		DRIVE WITH HEADLIGHTS ON AT ALL TIMES See Interim Addenda
S6-1		DRUG-FREE SCHOOL ZONE
R16-109		DUMPING PROHIBITED
R10-3E		Educational plaque for pedestrian signal (Countdown)
R10-3C		Educational plaque for pedestrian signals
R10-3D		Educational plaque for pedestrian signals (To Median)
D9-1C		Emergency 911 Telephone (Symbol)
D9-13C		Emergency Medical Care
I-13		Emergency Notification
I-13A		Emergency Notification (Alternate)
R8-4		EMERGENCY PARKING ONLY
EM-7A		EMERGENCY SHELTER XX MI (Arrow)
R10-13		EMERGENCY SIGNAL
W11-12P		EMERGENCY SIGNAL AHEAD
R7-203		EMERGENCY SNOW ROUTE NO PARKING IF OVER XX INCHES
R8-7		EMERGENCY STOPPING ONLY
R3-100		EMERGENCY VEHICLES EXEMPT (Plaque)
W14-100	W14-2A (<2002)	END
W16-111	W16-6 (<2002)	END AVALANCHE AREA
CW22-3		END BLASTING ZONE

Index - Sorted by Sign Message

Sign Number	Pre-2006 Sign Number (If Different)	Message
R12-107	R12-11 (<2002)	END CHAIN AREA
I-141	I-141E was M9-3, I-141B was M9-1 (<2002)	END CHECK MILE 5/BEGIN CHECK MILE 0
M4-8A		END DETOUR
R16-101	AK-CR16-101 (<2002)	END DOUBLE TRAFFIC FINES
W16-109	W16-13 (<2002)	END JETBLAST AREA
W14-102	W14-2C (<2002)	END MAINTENANCE 1500 FT
W16-107	W16-10 (<2002)	END OF FREEWAY 1/2 MI
W14-101	W14-2B (<2002)	END ROAD 1000 FT
G20-2	G20-2A (<2003)	END ROAD WORK
S5-2		END SCHOOL ZONE
S5-2A	S6-1 (<2002)	END SCHOOL ZONE (Plaque)
W16-101	W16-2 (<2002)	END SLIDE AREA
I-2C		ENTERING [Name] Borough
I-2E		ENTERING [Town Name]
I-2F		ENTERING GAME MANAGEMENT UNIT
W4-6		Entering Roadway Added Lane (Symbol)
W4-5		Entering Roadway Merge (Symbol)
W11-101	W11-7 (<2002)	Equestrian Crossing (Symbol)
R15-3		EXEMPT
E5-1		EXIT (Diagonal Right Arrow)
W13-2		EXIT 25 MPH (Advisory Speed Plate)
E1-5		EXIT 444
E5-2A		EXIT CLOSED (plaque)
E8-13		Exit Mileage (Three Exits)
E8-12		Exit Mileage (Two Exits)
E5-1A		EXIT Number (Diagonal Right Arrow)
E5-3		EXIT ONLY (plaque)
E11-1		EXIT ONLY w/ Down Arrow Plate
E5-2		EXIT OPEN (plaque)
EM-7C		FALLOUT SHELTER XX MI Arrow Hazard (Symbol)
W11-5		Farm Machinery Crossing (Symbol)
I-100	I-08 (<2002)	Ferry Terminal (Symbol)
R16-106	R16-1	FINE FOR LITTERING \$1000
M12-1		Fire Hydrant (Symbol)
W11-8A		FIRE STATION
W11-8		Fire Truck (Symbol)
CW20-7		Flagger Sign (Symbol) See Interim Addenda
LG-R1x3		FOOD (Arrows, Logos)
D9-201, 202, 203		FOOD, PHONE, GAS, LODGING, HOSPITAL, CAMPING (Text Signs)
R1-3		Four-WAY
W2-1		Four-Way Intersection (Symbol)
D13-3		Freeway Entrance
D13-3A		Freeway Entrance (Oblique Arrow)
CW21-2		FRESH OIL/TAR
LG-F3x1		GAS Logo
D9-204		General Community Service

Index - Sorted by Sign Message

Sign Number	Pre-2006 Sign Number (If Different)	Message
D9 Plates (1/3)		General Service Plates (D9-1 to D9-5)
D9 Plates (3/3)		General Service Plates (D9-101 to D9-106, D9-109)
D9 Plates (2/3)		General Service Plates (D9-6, D9-7, D9-9 to D9-13, D9-15, D9-100)
W11-11		Golf Cart Crossing (Symbol)
W11-9		Handicap Crossing (Symbol)
R14-3		Hazardous Material Prohibited (Symbol)
W7-102		HIDDEN DRIVEWAY
R3-5C		High Occupancy Vehicle (HOV) 2+ (Plaque)
W7-5		Hill (Bike) (Symbol)
W7-101		HILL BLOCKS VIEW
R14-2		HM Hazardous Material (Symbol)
W11-14		Horse and Buggy Crossing (Symbol)
W11-7	W11-11 (<2002)	Horse Crossing (Symbol)
D9-2		Hospital (Symbol)
EM-7B		HURRICANE SHELTER XX MI (Arrow)
I-162	AK-SP1-3 (<2002)	IN MEMORY OF _____
R12-106	R12-10 (<2002)	INSTALL CHAINS HERE (Arrow)
R1-6		In-Street Pedestrian Crossing (Yield) (Symbol)
D10-1A, 2A, 3A		Intermediate Reference Location Signs
W2-4		Intersection T (Symbol)
W2-5		Intersection Y (Symbol)
M2-1		JCT Plate
M2-2		JCT w/ 2 Route Markers
M2-2A (3)		JCT w/ 3 Route Markers
W16-108	W16-12 (<2002)	JETBLAST AREA
R4-8		Keep Left (Arrow and Symbol)
R9-7		KEEP LEFT Peds/RIGHT Bikes (Symbol)
R11-1		KEEP OFF MEDIAN
R16-107		KEEP OFF WET PAINT
R4-7B		KEEP RIGHT (45 deg. Arrow)
R4-7A		KEEP RIGHT (Hor. Arrow)
R4-7		Keep Right (Symbol)
R4-100		KEEP RIGHT EXCEPT TO PASS
R11-102		LANE CLOSED
CW4-2		Lane Ends (Symbol)
W4-2		Lane Ends (Symbol)
CW9-2		LANE ENDS MERGE LEFT (RIGHT) See Interim Addenda
W9-2		LANE ENDS MERGE LEFT (RIGHT)
R3-8 L/S		Lane Use Control - Multiple Lanes (Arrow)
R3-8 L/SL		Lane Use Control - Multiple Lanes (Arrow)
R3-8		Lane use control Options
R3-8 L/LR	R3-8L/DT (<2002)	Lane Use Control-Multiple Lanes (Arrow)
CW1-6		Large Arrow, One Way (Symbol)
I-171	I-15B (<2002)	Large SCENIC BYWAY (Symbol & Text)
I-2D		LEAVING [Name] Borough
I-2G		LEAVING GAME MANAGEMENT UNIT
R10-10		LEFT (or Right) TURN SIGNAL

Index - Sorted by Sign Message

Sign Number	Pre-2006 Sign Number (If Different)	Message
R3-5B		LEFT LANE (Plaque)
R10-5	R10-5A (<2002)	LEFT ON GREEN ARROW ONLY
R10-100	R10-13 (<2002)	Left Turn (Arrow) ONLY YIELD ON GREEN Ball (Symbol)
R10-12		LEFT TURN YIELD ON GREEN Ball (Symbol)
R3-6	R3-6SL (<2002)	Left Turn/Straight Movement ONLY (Arrows)
CW12-1		Left/Right (Down Arrows) (Symbol)
W12-1		Left/Right Down Arrows (Symbol)
R3-7		LEFT/RIGHT LANE MUST TURN LEFT/RIGHT
R12-102	R12-6 (<2002)	LEGAL LIMIT 75% OF MAXIMUM AXLE LOAD
I-8/I-8P		Library (Symbol), LIBRARY Plate
D9-103	D9-4 (<2002)	LITTER BARREL 1000 FT (Symbol)
LG-F3x2		LODGING CAMPING Logo
R15-8		LOOK (Arrows)
CW8-7		LOOSE GRAVEL
W11-107	W11-20 (<2002)	LOOSE LIVESTOCK
W12-2A		LOW CLEARANCE SYMBOL (One Arrow)
W12-2		LOW CLEARANCE SYMBOL (Two Arrows)
CW12-2		Low Clearance Symbol (Two Arrows) (Symbol)
W16-114		LOW FLYING AIRCRAFT
CW8-9		LOW SHOULDER
W8-9		LOW SHOULDER
EM-4		MAINTAIN TOP SAFE SPEED
R8-101		MAXIMUM PARKING 48 HRS
R10-3B		Meaning of Ped Signals
EM-6A		MEDICAL CENTER (Arrow)
W4-1		Merge (Arrow) (Symbol)
CW4-1		Merge (Symbol)
I-142	M9-2 (<2002)	MILE 4
R2-4		MINIMUM SPEED 40
S4-6		MON-FRI
R10-20a		MON-FRI, Hours (Three line), (Two line)
W11-103	W11-12 (<2002)	Moose Crossing (Symbol)
D9-18		Motor Services (Symbols) (Combination)
D9-18A		Motor Services (Word Message)
R5-8		MOTOR-DRIVEN CYCLES PROHIBITED
R9-101		Multi-Use (Symbol) PATHWAY
I-103		MUSEUM
CW5-2		NARROW BRIDGE
W5-2		NARROW BRIDGE
M1-7		NATIONAL FOREST ROUTE MARKER
CW3-3P		NEW SIGNAL (Plate)
CW3-100	W3-100 (<2003)	NEW TRAFFIC PATTERN
W3-100		NEW TRAFFIC PATTERN
I-111		NEXT 25 MI
W13-1A		NEXT 25 MILES (Advisory Plate)
W16-4		NEXT 500 FT
W7-3A		NEXT 7 MILES
W10-14		NEXT CROSSING
E2-1		NEXT EXIT 7 MILES (1 line)

Index - Sorted by Sign Message

Sign Number	Pre-2006 Sign Number (If Different)	Message
E2-1A		NEXT EXIT 7 MILES (2 lines)
D3-2D		NEXT INTERSECTION 4-Line Advance Street Name
R4-6B		NEXT PASSING LANE 2 MILES
D5-100		NEXT REST AREA 44 MILES
D5-6		NEXT REST AREA XX MILES
LG-FP2		NEXT RIGHT (2-Lines, Plaque)
LG-FP		NEXT RIGHT (Plaque)
D9-210		NEXT SERVICES 44 MILES
D3-2C		NEXT SIGNAL 3-Line Advance Street Name
W8-12		NO CENTER STRIPE
CW8-12		NO CENTER STRIPE
R16-108		NO FISHING FROM BRIDGE
W10-13		NO GATES OR LIGHTS
R9-4		NO HITCH HIKING
R3-2		No Left Turn (Symbol)
R3-2A		NO LEFT TURN ACROSS TRACKS
R10-11D		No Left Turn ON RED (Symbol)
R5-3		NO MOTOR VEHICLES
R5-3A, R5-3AP		NO MOTOR VEHICLES (Narrow), PATHWAY (Plate)
R12-112		NO OFF ROAD VEHICLES ON ROAD OR WITHIN 3 FT
W14-2		NO OUTLET
W14-2P		NO OUTLET w/ Arrow (Plate)
R8-3		NO PARKING
R8-3A		No Parking (Symbol)
R7-9A		No Parking (Symbol) BIKE LANE
R7-107A		No Parking (Symbol) BUS STOP
R7-200		NO PARKING ANY TIME (Left), ONE HOUR PARKING (Right)
R8-100		NO PARKING BEYOND THIS POINT
R7-9		NO PARKING BIKE LANE
R8-2		NO PARKING EXCEPT ON SHOULDER
R8-1		NO PARKING ON PAVEMENT
R7P-	R7- (<2002)	NO PARKING sign blank
R7 Pg 1		No Parking/Stopping Legend Options for R7S & R7P
R7 Pg 2		No Parking/Stopping Legend Options for R7S & R7P
R7 Pg 3		No Parking/Stopping Legend Options for R7S & R7P
R7 Pg 4		No Parking/Stopping Legend Options for R7S & R7P
CW14-3		NO PASSING ZONE
W14-3		NO PASSING ZONE
R9-3		NO PEDESTRIAN CROSSING
R9-3A		No Pedestrians (Symbol)
R3-1		No Right Turn (Symbol)
R3-1A		NO RIGHT TURN ACROSS TRACKS
R10-11C		No Right Turn ON RED (Symbol)
R11-100	R11-5 (<2002)	NO ROAD MAINTENANCE AFTER NOV 1
R16-104	R16-2	NO SHOOTING FROM ROADWAY
R16-105	R16-3	NO SHOOTING WITHIN 1/4 MILE OF ROADWAY
CW8-9B	CW8-10 (<2002)	NO SHOULDER
W10-10		NO SIGNAL
R8-6		NO STOPPING EXCEPT ON SHOULDER

Index - Sorted by Sign Message

Sign Number	Pre-2006 Sign Number (If Different)	Message
R8-5		NO STOPPING ON PAVEMENT
R7S-		NO STOPPING sign blank
R12-103	R12-7 (<2002)	NO STUDDERED TIRES (Dates)
W10-9		NO TRAIN HORN
R5-2		No Trucks (Symbol)
R12-3		NO TRUCKS OVER 7K LBS EMPTY WT
R10-11A		NO TURN ON RED (Rectangle)
R10-11B		NO TURN ON RED (Square)
W14-2D		NO TURNAROUND
R3-3		NO TURNS
R3-4		No U-Turn (Symbol)
R5-7		NON-MOTORIZED TRAFFIC PROHIBITED
M3-1, M3-2		NORTH, EAST (Plates)
I-131		NOTICE THIS PARKING AREA IS FOR COMMUTERS ONLY
E9-11		Number of Exits to One City
E9-12		Number of Exits to Two Cities
OM1-1, 2, 3		Object Marker (Type 1) See Interim Addenda
OM2-1V, 2V, 1H, 2H		Object Marker (Type 2)
OM-3L, 3C, 3R		Object Marker (Type 3)
OM4-1, 2, 3		Object Marker (Type 4) See Interim Addenda
M1-2		Off-Interstate Business Loop Marker (Symbol)
M1-3		Off-Interstate Business Spur Marker (Symbol)
R8-3D		ON BRIDGE (Supplemental Plaque)
R8-3C		ON PAVEMENT (Supplemental Plaque)
CW13-4		ON RAMP
W4-4B		ONCOMING TRAFFIC DOES NOT STOP
W25-1		ONCOMING TRAFFIC HAS EXTENDED GREEN
W25-2		ONCOMING TRAFFIC MAY HAVE EXTENDED GREEN
CW5-3		ONE LANE BRIDGE
W5-3		ONE LANE BRIDGE
W6-100	W6-4(1-2) (<2002)	One Lane Opposing Two Lanes (Arrows) (Symbol)
CW20-4		ONE LANE ROAD _____ See Interim Addenda
CW6-100		One Lane with 2 Advancing Lanes
D1-1		One Line Destination & Arrow
D2-1		One Line Destination & Mileage
D1-1A		One Line Destination, Arrow & Mileage
D3-1B		One Line Overhead Street Name
W1-6		One Way (large Arrow) (Symbol)
R6-1		ONE WAY (Left/Right Arrow)
R6-2		ONE WAY (Left/Right Arrow)
R8-1A		OR WITHIN 8 FEET
R7-111		PARALLEL PARKING ONLY
D4-100		PARK & RIDE (Car & Bus Symbol)
D4-2		PARK & RIDE (Car Symbol)
D4-1		PARKING (Arrow)
D9-105	D9-14 (<2002)	PARKING (Symbol & Text Plaque)
D5-4		PARKING AREA (Oblique Arrow)
D5-3		PARKING AREA X MILES

Index - Sorted by Sign Message

Sign Number	Pre-2006 Sign Number (If Different)	Message
D5-3C		PARKING AREA X MILES (Horizontal Arrow)
I-3B		Pass Name and Elevation - 2 Line
R4-2		PASS WITH CARE
R4-6A		PASSING LANE 2 MILES
CW8-100		PAVEMENT BREAK
CW8-3		PAVEMENT ENDS
W8-3		PAVEMENT ENDS
M4-9A		PEDESTRIAN BIKE DETOUR (Symbols, Arrow)
R9-8		PEDESTRIAN CROSSWALK
M4-9B		PEDESTRIAN DETOUR (Symbol, Arrow)
R9-100		PEDESTRIANS (Arrow)
R5-10B		PEDESTRIANS AND BICYCLES PROHIBITED
R5-10A		PEDESTRIANS BICYCLES MOTOR DRIVEN CYCLES PROHIBITED
R5-10C		PEDESTRIANS PROHIBITED
D5-5C		PICNIC AREA Horizontal Arrow
G20-4		PILOT CAR FOLLOW ME
D8-101		Plaque (OPEN/CLOSED)
R8-3AP	R8-30 (<2002)	Plaque for R8-3a, Seven Message Options
W15-1		Playground (symbol)
I-164		PLEASE BUCKLE UP
I-160	AK-SP1-1 (<2002)	PLEASE DON'T DRINK AND DRIVE
I-161	AK-SP1-2 (<2002)	PLEASE DRIVE SAFELY
I-130		PLEASE LIMIT YOUR STAY TO 8 HOURS - NO TENTS OR CAMPS
D9-14		Police Assistance
D9-107	D9-19 (<2002)	Post Office
D9-108	D9-19C (<2002)	Post Office 1 Mile
W16-113		PRIMITIVE ROAD NO WARNING SIGNS
D9-15		Propane (Symbol)
D9-230		Public Dumpster See Interim Addenda
R10-4B		PUSH BUTTON FOR Walk (Symbol)
D7-RA Plates (1/2)		RA Accommodation Service Plates page (1 of 2)
D7-RA Plates (2/2)		RA Accommodation Service Plates page (2 of 2)
W10-5		Rail-Highway Low Ground Clearance (Symbol)
W10-1		Railroad Advance Crossing (Symbol)
R15-1		RAILROAD CROSSING (Cross Bucks)
W10-3		Railroad Crossing Advance Intersecting Road (Right) (Symbol)
W10-2	W10-4 (<2002)	Railroad Crossing Advance of Road Intersection (Symbol)
W10-4		Railroad Crossing At T Intersection - 90 degrees to Main Road (Symbol)
W13-3		RAMP 30 MPH (Advisory Speed Plate)
CW5-4		RAMP NARROWS
W5-4		RAMP NARROWS
D7-100		RECREATION AREA NEXT RIGHT (Symbol Template)
I-11		Recycling Collection Center (Symbol)
S4-5		Reduced Speed (School) Zone Ahead MPH (symbol)
R2-5A		REDUCED SPEED AHEAD
EM-6C		REGISTRATION CENTER (Arrow)

Index - Sorted by Sign Message

Sign Number	Pre-2006 Sign Number (If Different)	Message
R7-8		RESERVED PARKING HANDICAPPED (Symbol)
D5-102		REST AREA
D5-2	I-21 (<2002)	REST AREA (Arrow)
D5-104		REST AREA (Arrow)
D5-1		REST AREA 2 MILES
D5-101		REST AREA NEXT RIGHT
D5-8		REST AREA TOURIST INFO CENTER (Oblique Arrow)
D5-7		REST AREA TOURIST INFO CENTER XX MILES
W1-4		Reverse Curve (Arrow) (Symbol)
CW1-4		Reverse Curve (Symbol)
W1-3		Reverse Turn (Arrow) (Symbol)
R3-9D		Reversible Lane Control Signs
R3-9F		Reversible Lane Control Signs
R3-9G		Reversible Lane Control Signs
R3-9H		Reversible Lane Control Signs
R3-9I		Reversible Lane Control Signs
D7-RG Plates (1/2)		RG General Information Plates page (1 of 2)
D7-RG Plates (2/2)		RG General Information Plates page (2 of 2)
R9-3C		RIDE WITH TRAFFIC
CW9-1		RIGHT (LEFT) LANE ENDS See Interim Addenda
W9-1		RIGHT (LEFT) LANE ENDS
CW21-5A		RIGHT (LEFT) SHOULDER CLOSED See Interim Addenda
R3-5F		RIGHT LANE (Plaque)
R3-101	R3-17 (<2006)	RIGHT LANE Bikes ONLY (Symbol)
CW20-5		RIGHT LANE CLOSED _____ See Interim Addenda
W16-6P		Right Turn, Left Turn Arrow (Plaque)
CW20-5A		RIGHT TWO LANES CLOSED _____ See Interim Addenda
W16-5P		Right, Left Arrow (Plaque)
R3-5		Right/Left Turn ONLY (Arrow)
I-3		River Name - 2 Line
D7-RL Plates (1/2)		RL Land Recreation Plates page (1 of 2)
D7-RL Plates (2/2)		RL Land Recreation Plates page (2 of 2)
D7-RM Plates (1/2)		RM Motorist Service Plates page (1 of 2)
D7-RM Plates (2/2)		RM Motorist Service Plates page (2 of 2)
R11-2		ROAD CLOSED
CW20-3		ROAD CLOSED _____ See Interim Addenda
R11-3	R11-3A (<2002)	ROAD CLOSED 10 MILES AHEAD LOCAL TRAFFIC ONLY
W14-103	W14-5A (<2002)	ROAD CLOSED AHEAD
R11-101	R11-6 (<2002)	ROAD CLOSED AVALANCHE AREA
R11-4		ROAD CLOSED TO THRU TRAFFIC
CW21-3		ROAD MACHINERY _____
CW5-1		ROAD NARROWS
W5-1		ROAD NARROWS
CW8-5		Road Slippery When Wet (Symbol)
EM-5		ROAD USE PERMIT REQUIRED FOR THRU TRAFFIC
CW20-100	CW21-4 (<2002)	ROAD WORK _____ See Interim Addenda
G20-1		ROAD WORK NEXT XX MILES
D5-5B		ROADSIDE PARK (Horizontal Arrow)
D5-5D		ROADSIDE PARK XX MILES

Index - Sorted by Sign Message

Sign Number	Pre-2006 Sign Number (If Different)	Message
D5-5		ROADSIDE TABLE (Horizontal Arrow)
D5-5A		Roadside Table (Symbol)
D5-5E		ROADSIDE TABLE XX MILES
W16-105	W16-8 (<2002)	ROCKS
W10-15		ROUGH CROSSING
CW8-8		ROUGH ROAD
W2-6A		ROUNDBOUT (Plaque)
W2-6		Roundabout Ahead (Symbol)
D1-100		Roundabout Destination
D7-RS Plates (1/2)		RS Winter Recreation Plates page (1 of 2)
D7-RS Plates (2/2)		RS Winter Recreation Plates page (2 of 2)
W7-4B	W7-4A (<2002)	RUNAWAY TRUCK RAMP (w/ Arrow)
W7-4		RUNAWAY TRUCK RAMP X MILE
R4-10		RUNAWAY VEHICLES ONLY
D9-100		RV PARK
D7-RW Plates (1/2)		RW Water Recreation Plates page (1 of 2)
D7-RW Plates (2/2)		RW Water Recreation Plates page (2 of 2)
R16-113		SAFETY ZONE BEGIN DOUBLE TRAFFIC FINES
R2-101		SAFETY ZONE SPEED LIMIT 45 DOUBLE FINES (Yellow)
W7-4D/E/F		SAND/GRAVEL/PAVED (Plaques)
D6-1		SCENIC AREA (Horizontal Arrow)
D6-3		SCENIC AREA (Oblique Arrow)
D6-2		SCENIC OVERLOOK XX MILES
S4-3		SCHOOL
I-102		School (Symbol) w/ SCHOOL plaque
S3-1		SCHOOL BUS STOP AHEAD
S5-1		SCHOOL SPEED LIMIT 20 MPH WHEN FLASHING
W16-1		SHARE THE ROAD
W8-9A		SHOULDER DROP-OFF
W5-1A		SHOULDER NARROWS
CW21-5		SHOULDER WORK
W2-2		Side Road (90 Degree) (Symbol)
W2-3		Side Road (45 Degree) (Symbol)
R9-9		SIDEWALK CLOSED
R9-11		SIDEWALK CLOSED AHEAD CROSS HERE (Arrow)
R9-11A		SIDEWALK CLOSED CROSS HERE (Arrow)
R9-10		SIDEWALK CLOSED USE OTHER SIDE (Arrow)
CW3-3	CW3-3B (<2002)	Signal Ahead (Symbol)
W3-3		Signal Ahead (Symbol)
I-1		SIGNALS SET FOR 25 MPH
D10-1, 2, 3, 400		Single-Faced 1, 2, 3, and 4 digit Mile Marker Signs
W10-12		Skewed Crossing (symbol)
W16-100	W16-1 (<2002)	SLIDE AREA
W8-10		SLIPPERY WHEN WET (Bike Symbol)
W8-10A		SLIPPERY WHEN WET (Plaque)
CW8-5P		SLIPPERY WHEN WET (Plate)
W8-5P		SLIPPERY WHEN WET (Plate)
W8-5		Slippery When Wet (Symbol)

Index - Sorted by Sign Message

Sign Number	Pre-2006 Sign Number (If Different)	Message
W7-100	W7-6 (<2002)	SLOW MOVING VEHICLES
CW23-100B	CW23-1B (<2002)	SLOW Paddle (Back)
I-121	D9-22A (<2002)	SLOW VEHICLE TURNOUT (Arrow)
I-122	D9-22 (<2002)	SLOW VEHICLE TURNOUT 1000 FT
I-120	D9-22B (<2002)	SLOW VEHICLES USE TURNOUTS NEXT 2 MILES
R4-3		SLOWER TRAFFIC KEEP RIGHT
W11-100	W11-6 (<2002)	Snowmobile Crossing (Symbol)
CW8-4		SOFT SHOULDER
W8-4		SOFT SHOULDER
M3-3, M3-4		SOUTH, WEST (Plates)
W17-1		SPEED HUMP
R2-1		SPEED LIMIT 50
R2-5C		SPEED ZONE AHEAD
I-140		SPEEDOMETER CHECK SECTION AHEAD
I-163	AK-SP1-4 (<2002)	SPONSORED BY THE _____ FAMILY
I-180	M8-1 (<2002)	STATE MAINTENANCE BEGINS
I-181	M8-2 (<2002)	STATE MAINTENANCE ENDS
D9-220	D9-18 (<2002)	STATE TROOPERS (w/ Arrow)
D9-221	D9-18C (<2002)	STATE TROOPERS 1 MILE
R4-9		STAY IN LANE
R1-1		STOP
R16-111		STOP - FOLLOW PILOT CAR WHEN GOING YOUR WAY
CW3-1A		Stop Ahead (Symbol)
W3-1A	W3-1 (<2002)	Stop Ahead (Symbol)
R10-6		STOP HERE ON RED (Arrow), (Left and Right)
R8-10		STOP HERE WHEN FLASHING (Arrow)
CW23-100F	CW23-1A (<2002)	STOP Paddle (Front)
R3-5A		Straight ONLY (Arrow)
D3-1		Street Name (small sign)
D3-1A		Street Name w Block Number (small sign)
D3-1D		Street Name w Block Number (small sign)
R5-100	R5-5A (<2002)	STUDED TIRES PROHIBITED
R12-108		STUDS OR CHAINS REQUIRED NEXT 3 MILES
CW21-6		SURVEY CREW
R3-5D		TAXI LANE (Plaque)
D9-1		Telephone (Symbol)
D9-1B	D9-1A (<2002)	Telephone 1/4 MILE (Symbol)
D9-1A		Telephone w/ Arrow (Symbol)
M4-7		TEMPORARY (Plate)
D9-3		Tent Camping (Symbol)
D9-3X	D9-3B (<2002)	Tent Camping Prohibited (Symbol)
CW1-4C		Three Lane Curves Ahead (Symbol)
D1-3-2	D1-3 (<2002)	Three Line Destination & 2 Arrows (2 Destinations in one direction, 1 in another)
D1-3-3	D1-3 (<2002)	Three Line Destination & 3 Arrows (All destinations in different directions)
D2-3		Three Line Destination & Mileage
D1-3A-2	D1-3A (<2002)	Three Line Destination, 2 Arrows & Mileage (2 destinations in same direction, 1 in another)

Index - Sorted by Sign Message

Sign Number	Pre-2006 Sign Number (If Different)	Message
D1-3A-3	D1-3A (<2002)	Three Line Destination, 3 Arrows & Mileage (All destinations in different directions)
D7-1	D7-3 (<2002)	Three Line Rectangular Recreational Destination & Distance
R15-2		Three TRACKS
CW4-1A		THRU TRAFFIC MERGE LEFT See Interim Addenda
CW4-1B		THRU TRAFFIC MERGE RIGHT See Interim Addenda
R10-3A		TO CROSS (Arrow) STREET PUSH BUTTON WAIT FOR GREEN LIGHT
R10-4A		TO CROSS STREET (Arrow) PUSH BUTTON WAIT FOR WALK SIGNAL
R1-2A		TO ONCOMING TRAFFIC
R10-22		TO REQUEST GREEN WAIT ON Bicycle (Symbol)
R1-100		TO VEHICLES IN CIRCLE (Plaque)
D5-7A		TOURIST INFO CENTER
I-200		TOURIST INFO CENTER
I-201		TOURIST INFO KIOSK
D9-205		Tourist Oriented Service Sign (TODS)
R7-201, 201A, 201B	R7-201, R7-201A, R7-202 (<2002)	TOW-AWAY ZONE, Tow-Away Zone (Symbol), THIS SIDE OF SIGN
I-2B		Town Name
I-2A		Town Name CITY LIMITS
W10-11		Tracks Near Intersection (symbol)
R8-9		TRACKS OUT OF SERVICE
EM-3		TRAFFIC CONTROL POINT
W4-4A		TRAFFIC FROM LEFT DOES NOT STOP
I-4A		Trail Name (Arrow)
D7-105	D7-4 (<2002)	TRAIL of '98 (Arrow)
D9-4	D9-3A (<2002)	Trailer Camping (Symbol)
D9-4X	D9-3C (<2002)	Trailer Camping Prohibited (Symbol)
I-7		Train Station (Symbol)
W14-105		TRAVEL BEYOND THIS POINT...
D9-104	D9-15 (<2002)	TROOPERS (Symbol & Text Plaque)
CW8-6		TRUCK CROSSING
W8-6		TRUCK CROSSING
W11-10		Truck Crossing (Symbol)
W7-4C		TRUCK ESCAPE RAMP
R4-6		TRUCK LANE 500 FEET
CW7-1		Truck on Hill (Symbol)
W7-1		Truck on Hill (Symbol)
W7-1A		Truck On Hill 9% Slope (Symbol)
D9-16		Truck Parking (Word Message)
W1-13		Truck Rollover (Symbol)
R14-1		TRUCK ROUTE
R14-1A		TRUCK ROUTE (Arrow)
M4-4, 5, 6		TRUCK, TO, END (Plates)
R2-2		TRUCKS 40
R13-100		TRUCKS OVER 16,000 GVWR STOP AT SCALES WHEN OPEN
W7-2B	W7-2 (<2002)	TRUCKS USE LOWER GEAR

Index - Sorted by Sign Message

Sign Number	Pre-2006 Sign Number (If Different)	Message
R4-5		TRUCKS USE RIGHT LANE
EM1-100	CD-100 (<2003) AK-CD-1A (previous)	TSUNAMI EVACUATION ROUTE (Symbol)
W1-1A		Turn (Symbol) w/ advisory speed (Left and Right)
W1-100	W1-9 (<2002)	Turn Arrow 180 Degree (Symbol)
W1-101	W1-10 (<2002)	Turn Arrow 360 Degree (Symbol)
W1-1		Turn Arrow 90 Degree (Symbol) (Left and Right)
CW22-2		TURN OFF 2-WAY RADIOS AND PHONES
R10-15		TURNING TRAFFIC MUST YIELD TO PEDESTRIANS
E3-12		Two Destinations (Arrow)
E4-12		Two Destinations (Arrow)
E2-12		Two Destinations NEXT RIGHT
E3-22		Two Destinations w/ Route Marker and Arrow
E4-22		Two Destinations w/ Route Marker and Arrow
R7-108	R7-108B (<2002)	Two HR PARKING (Arrow) 8:30 am - 5:30 pm
CW1-4B		Two Lane Curves Ahead (Symbol)
D3-1C		Two Line Advance Street Name and Arrow
D1-2-2	D1-2 (<2002)	Two Line Destination & Arrow (Destinations in different directions)
D1-2-1	D1-2 (<2002)	Two Line Destination & Arrow (Destinations in same direction)
D2-2		Two Line Destination & Mileage
D1-2A-2	D1-2A (<2002)	Two Line Destination, 2 Arrows & Mileage (Destinations in different directions)
D1-2A-1	D1-2A (<2002)	Two Line Destination, Arrow & Mileage (Destinations in same direction)
D7-2	D7-2A (2002)	Two Line Trapezoidal Destination & Arrow See Interim Addenda
CW1-7		Two Way (large Arrow) (Symbol)
W1-7		Two Way (large Arrow) (Symbol)
W6-3		Two Way Traffic (Arrows) (Symbol)
CW6-3		Two Way Traffic (Symbol)
CW6-4		Two Way Traffic (Symbol)
R3-4B		U and 2 Left Turn (Arrows)
R3-4A		U and Left Turn (Arrows)
CW8-11		UNEVEN LANES
R7-300		UNLESS YOU NEED VAN ACCESS PLEASE USE OTHER ACCESSIBLE SPACES FIRST
R9-3B		USE CROSSWALK (Arrow)
R10-8		USE LANE WITH GREEN ARROW
W10-14A		USE NEXT CROSSING
CW21-7		UTILITY WORK _____
R10-16		U-TURN YIELD TO RIGHT TURN
R7-8A		VAN ACCESSIBLE
R5-5		VEHICLES WITH LUGS PROHIBITED
R9-1		WALK ON LEFT FACING TRAFFIC
W16-102	W16-3 ICY (<2002)	WATCH FOR ICE
D9-106	D9-13 (<2002)	WATER (Symbol & Text Plaque)
W16-103	Replaced W16-4 and W16-14	WATER OVER ROADWAY
D12-100	D12-1 (<2002)	WEATHER INFO TUNE RADIO TO _____

Index - Sorted by Sign Message

Sign Number	Pre-2006 Sign Number (If Different)	Message
D8-3		WEIGH STATION (Diagonal Right Arrow)
D8-1		WEIGH STATION 1 MILE
R13-102		WEIGH STATION CLOSED/TRUCKS OVER 16,000 GVWR STOP AT SCALES
R13-101		WEIGH STATION CLOSED/TRUCKS STOP AT SCALES
D8-2		WEIGH STATION NEXT RIGHT
D8-100	D8-2 (<2002)	WEIGH STATION RIGHT LANE
R12-1		WEIGHT LIMIT 10 TONS
R12-4		WEIGHT LIMIT 2 TONS PER AXLE 10 TONS GROSS
R12-5		WEIGHT LIMIT 8T 12T 16T (Symbol)
R12-100	R12-5A (<2002)	WEIGHT LIMIT TANDEM GROUP 16K LBS
R12-101	R12-5B (<2002)	WEIGHT LIMITS AXLE 16K LBS TANDEM GROUP 28K LBS
I-101		WELCOME TO [Town Name]
D9-206		WELCOME TO Community
EM-6B		WELFARE CENTER (Arrow)
S4-2		WHEN CHILDREN ARE PRESENT (3 lines)
S4-4		WHEN FLASHING
W16-13		WHEN FLASHING
W16-104	W16-7 (<2002)	WIND AREA
W1-5		Winding Road (Arrow) (Symbol)
R16-100	AK-CR16-100 (<2002)	WORK ZONE BEGIN DOUBLE TRAFFIC FINES
CW21-1A		Working Crew (Symbol)
R2-100	AK-CR2-100 (<2002)	WORKZONE SPEED LIMIT 45 DOUBLE FINES
R5-1A		WRONG WAY
R5-1B		WRONG WAY Bicycle (Symbol)
W10-11A		XX FT BETWEEN TRACKS & HIGHWAY
W10-11B		XX FT BETWEEN TRACKS & HIGHWAY BEHIND YOU
W16-3A		XX MILES (1 line)
W16-3		XX MILES (2 lines)
R1-2		YIELD
CW3-2A		Yield Ahead (Symbol)
W3-2	W3-2A (<2006), W3-2 (<2002)	Yield Ahead (Symbol)
R1-5AL		YIELD HERE TO PEDESTRIANS (Left) (Symbol)
R1-5L		Yield Here To Pedestrians (Left) with Ped (Symbol)
R1-5AR		YIELD HERE TO PEDESTRIANS (Right) (Symbol)
R1-5R		Yield Here To Pedestrians (Right) with Ped (Symbol)

CONSTRUCTION WARNING SIGNS

CW1-1 to CW24-1B

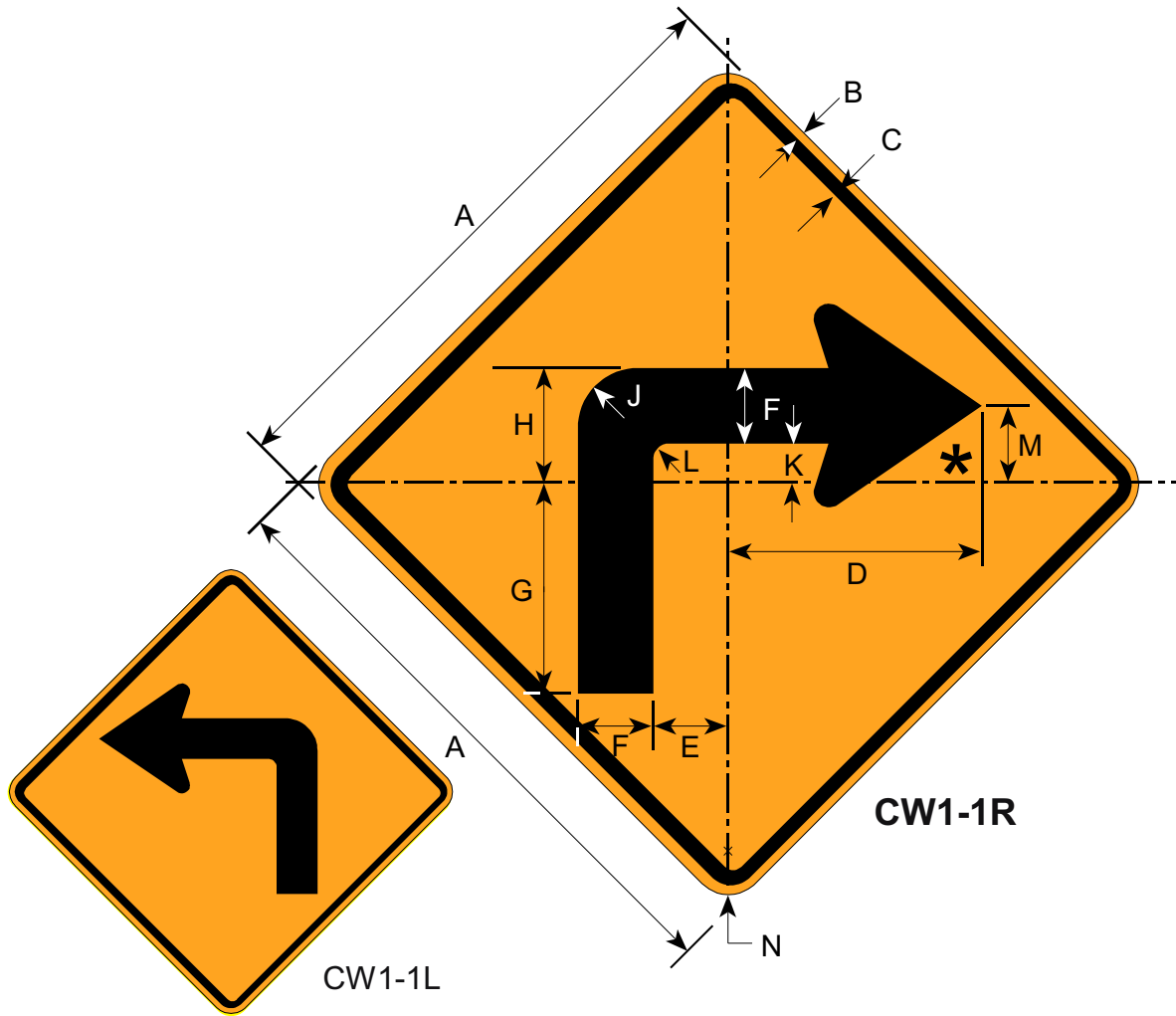

* See Appendix B-1 for Standard Arrow Details.

Border and Legend: Black
Background: Orange

Road Class	Dimensions (inches)												
	A	B	C	D	E	F	G	H	J	K	L	M	N
Bike	18	0.38	0.63	7.25	2.25	2.63	5.88	3.75	1.88	1.0	0.63	2.5	1.5
Minimum	30	0.50	0.75	12	3.75	4.38	9.69	6.25	3.0	1.88	1.0	4.06	1.88
Conventional	36	0.63	0.88	14.38	4.5	5.25	11.63	7.5	3.63	2.25	1.25	4.88	2.25
Expwy/Fwy	48	0.75	1.25	19.19	6.0	7.0	15.5	10	4.88	3.0	1.63	6.5	3.0

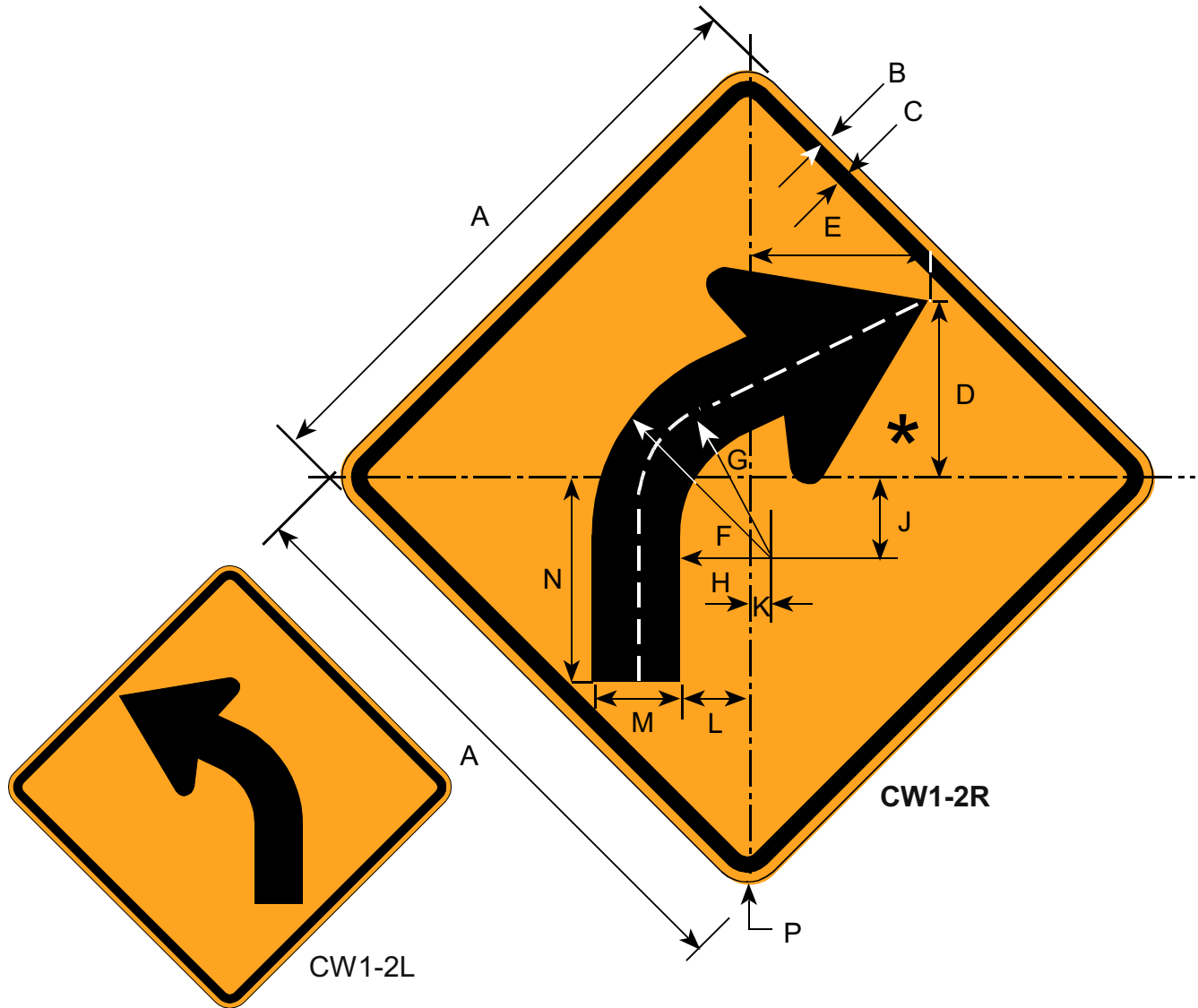

* See Appendix B-1 for Standard Arrow Details.

Border and Legend: Black
Background: Orange

Road Class	Dimensions (inches)													
	A	B	C	D	E	F	G	H	J	K	L	M	N	P
Bike	18	0.38	0.63	5.38	5.5	6.0	4.75	3.38	1.75	1.25	2.0	2.63	6.25	1.5
Minimum	30	0.50	0.75	8.88	9.06	10	7.81	5.63	2.94	2.19	3.44	4.38	10.31	1.88
Conventional	36	0.63	0.88	10.88	10.88	12	9.38	6.75	3.50	2.63	4.25	5.25	12.38	2.25
Expwy/Fwy	48	0.75	1.25	14.81	14.25	16	12.5	9.0	4.69	3.5	5.5	7.0	16.5	3.0

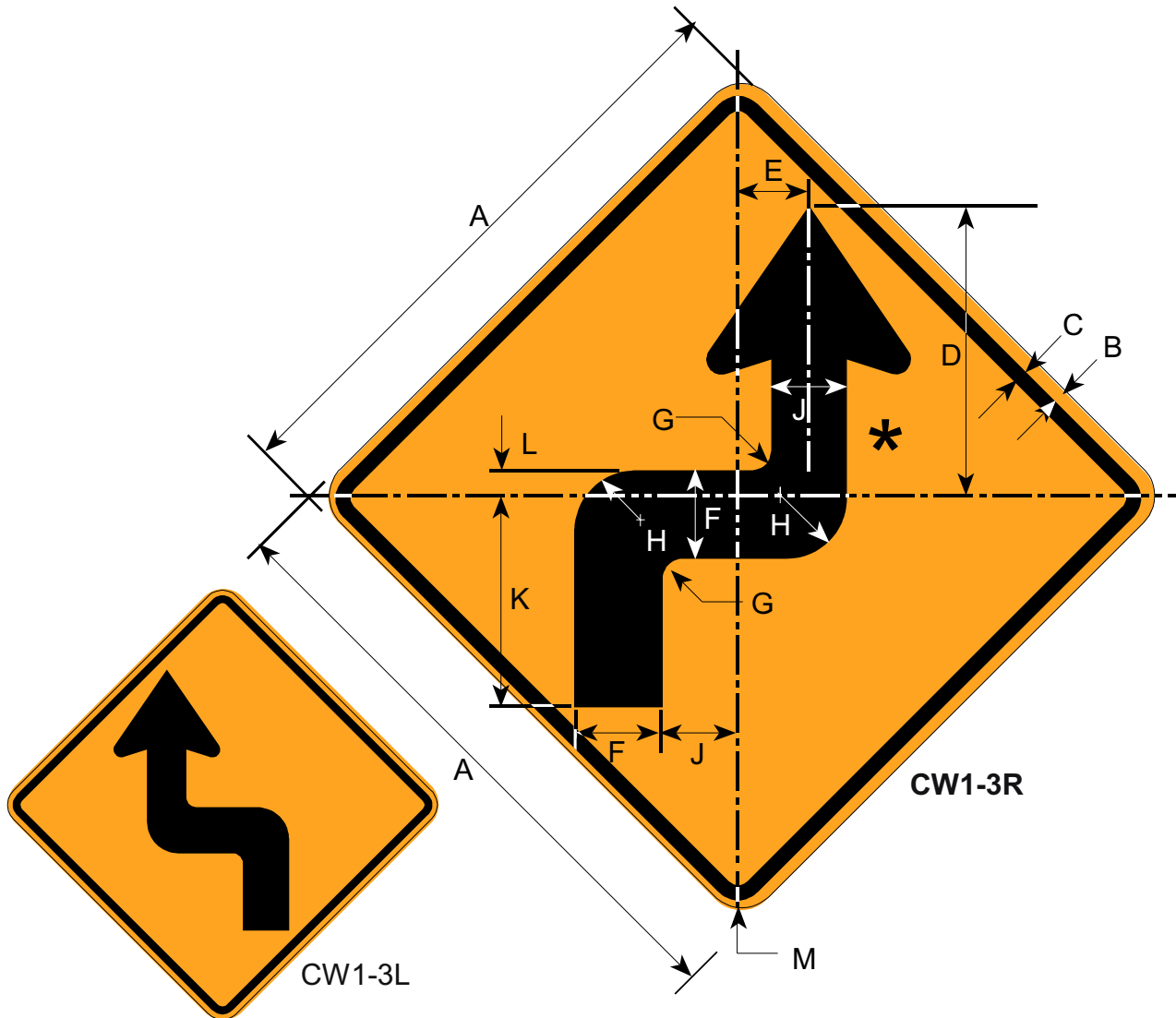

*See Appendix B-1 for Standard Arrow Details.

Border and Legend: Black
Background: Orange

Road Class	Dimensions (inches)											
	A	B	C	D	E	F	G	H	J	K	L	M
Minimum	30	0.50	0.75	14.5	3.5	4.38	1.0	3.0	3.75	10.38	1.38	1.88
Conventional	36	0.63	0.88	17.44	4.22	5.25	1.25	3.63	4.5	12.47	1.66	2.25
Expwy/Fwy	48	0.75	1.25	23.19	5.63	7.0	1.63	4.88	6.0	16.63	2.19	3.0

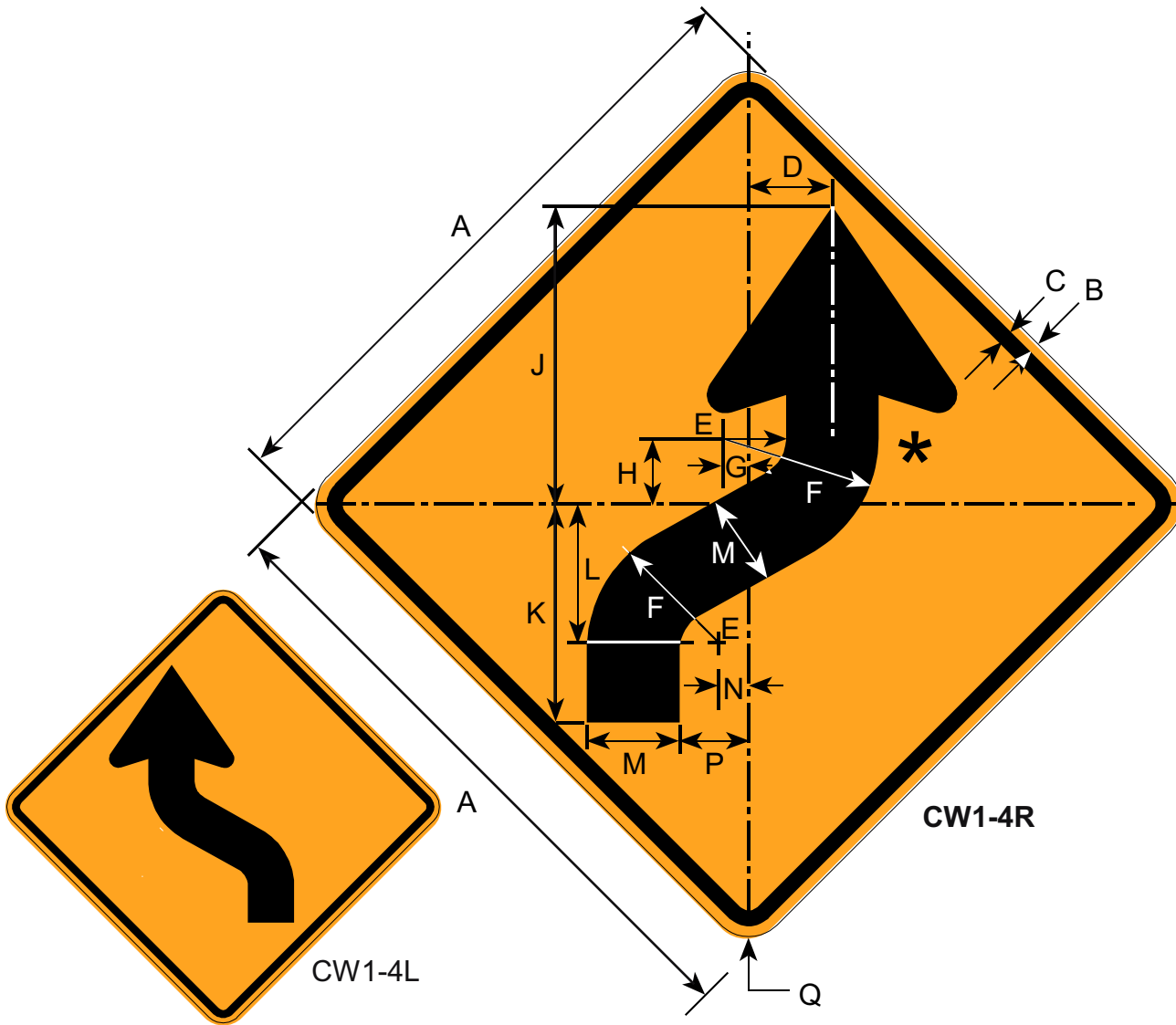

*See Appendix B-1 for Standard Arrow details.

Border and Legend: Black
Background: Orange

Road Class	Dimensions (inches)															
	A	B	C	D	E	F	G	H	J	K	L	M	N	P	Q	
Minimum	30	0.50	0.75	3.94	1.88	6.25	0.38	4.38	14.06	10.94	6.56	4.38	1.81	3.28	1.88	
Conventional	36	0.63	0.88	4.72	2.25	7.5	0.47	5.25	16.88	12.38	7.88	5.25	1.69	3.94	2.25	
Expwy/Fwy	48	0.75	1.25	6.31	3.0	10	0.63	7.0	22.5	16.5	10.5	7.0	2.25	5.25	3.0	

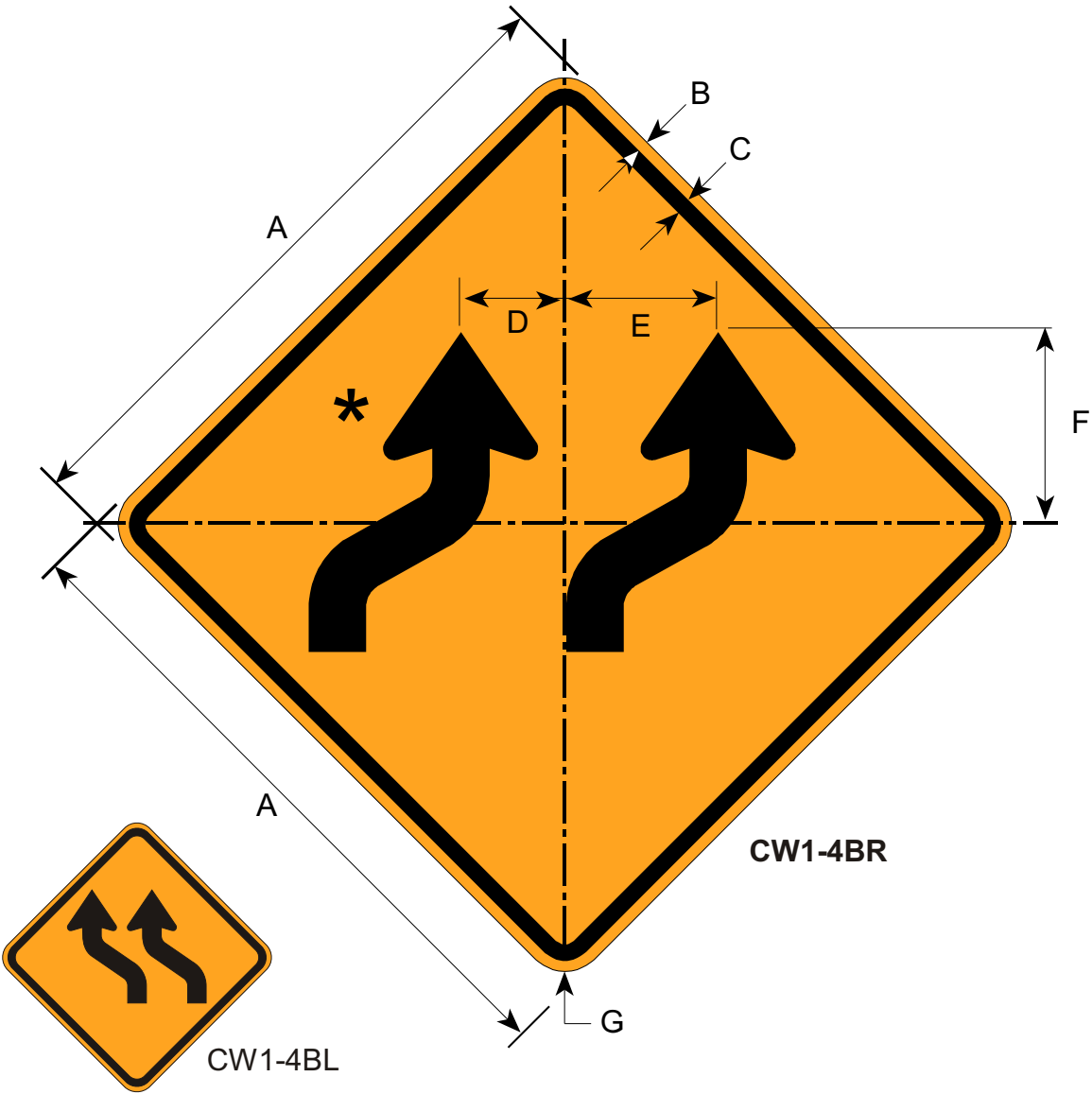

*Make arrows proportional to arrow shown in CW1-4 and reduce them to 57% of its size.

Border and Legend: Black
Background: Orange

Road Class	Dimensions (inches)						
	A	B	C	D	E	F	G
Minimum	30	0.50	0.75	2.24	6.81	10.25	1.88
Conventional	36	0.63	0.88	3.04	8.53	12.89	2.25
Expwy/Fwy	48	0.75	1.25	4.24	10.25	15.37	3.0

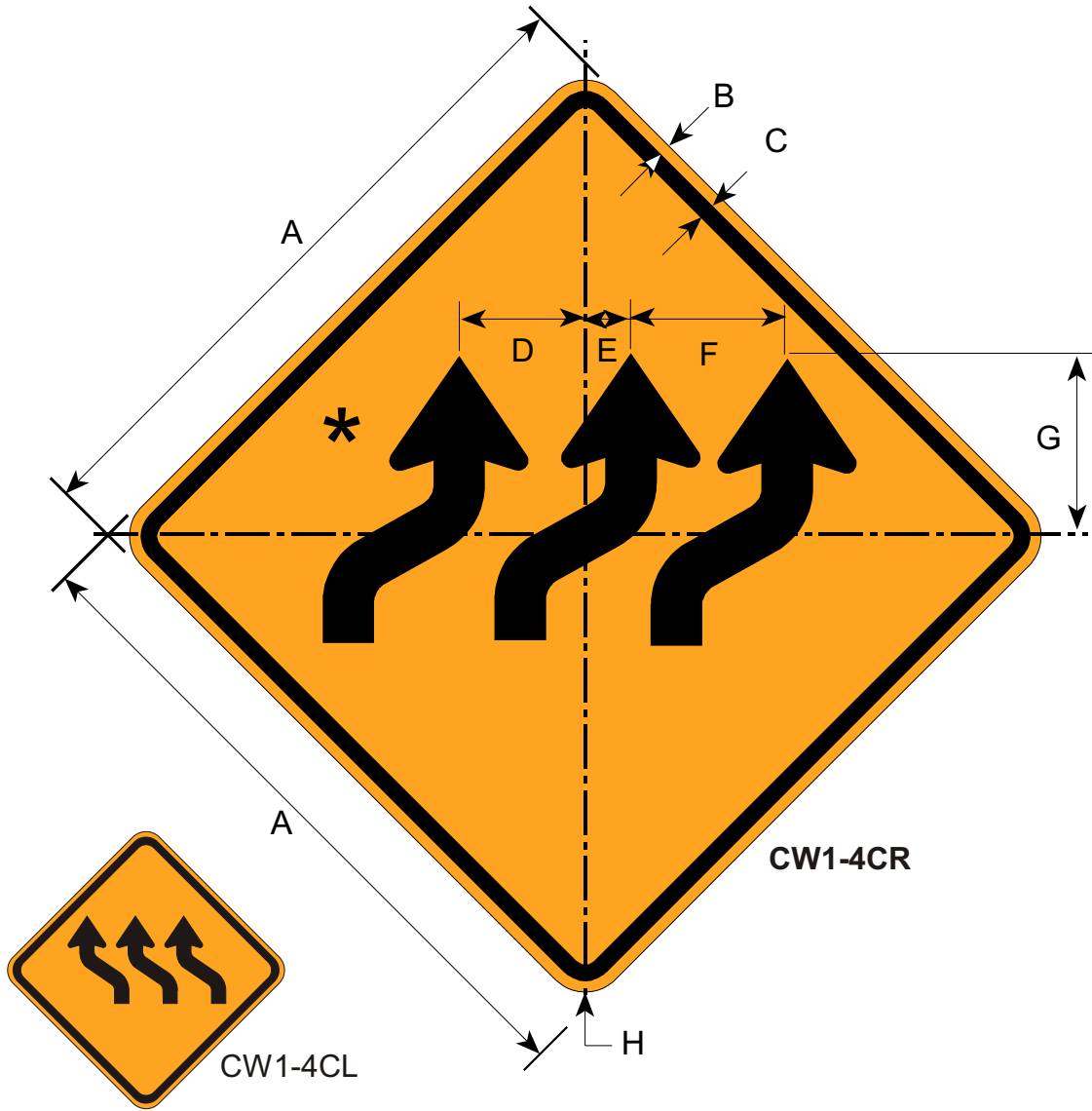

*Make arrows proportional to arrow shown in CW1-4 and reduce them to 53% of its size.

Border and Legend: Black
Background: Orange

Road Class	Dimensions (inches)							
	A	B	C	D	E	F	G	H
Minimum	30	0.50	0.75	5.4	1.48	7.25	8.57	1.88
Conventional	36	0.63	0.88	7.13	1.64	9.29	10.77	2.25
Expwy/Fwy	48	0.75	1.25	8.89	2.48	11.4	12.81	3.0

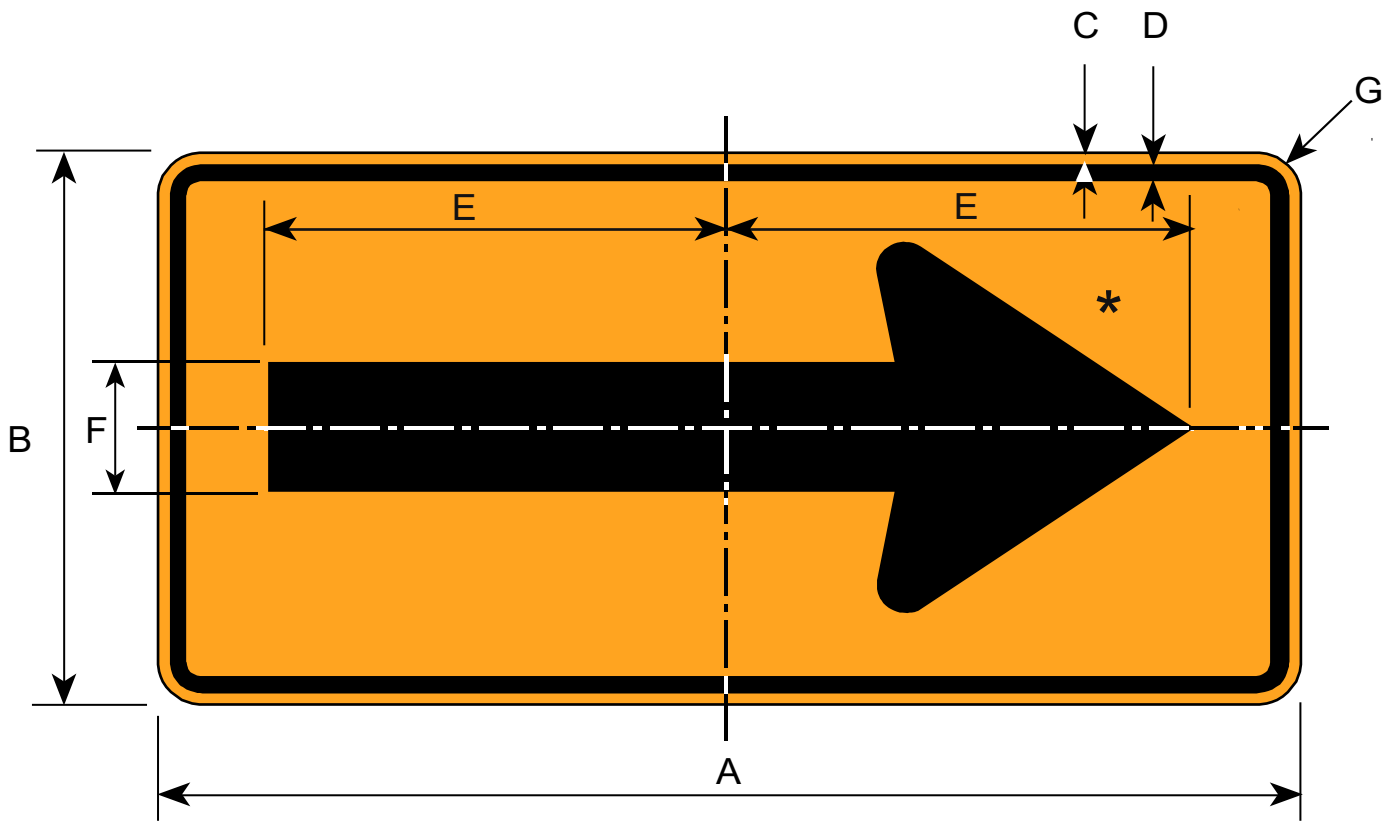

CW1-6R



CW1-6L

* See Appendix B-1 for Standard Arrow Details.

Border and Legend: Black
Background: Orange

Road Class	Dimensions (inches)						
	A	B	C	D	E	F	G
Bike	24	12	0.38	0.63	9.63	3.25	1.5
Minimum	36	18	0.38	0.63	14.63	5.0	1.5
Conventional	48	24	0.50	0.75	19.5	6.5	1.88
Expwy/Fwy	60	30	0.63	0.88	24.38	8.0	2.25

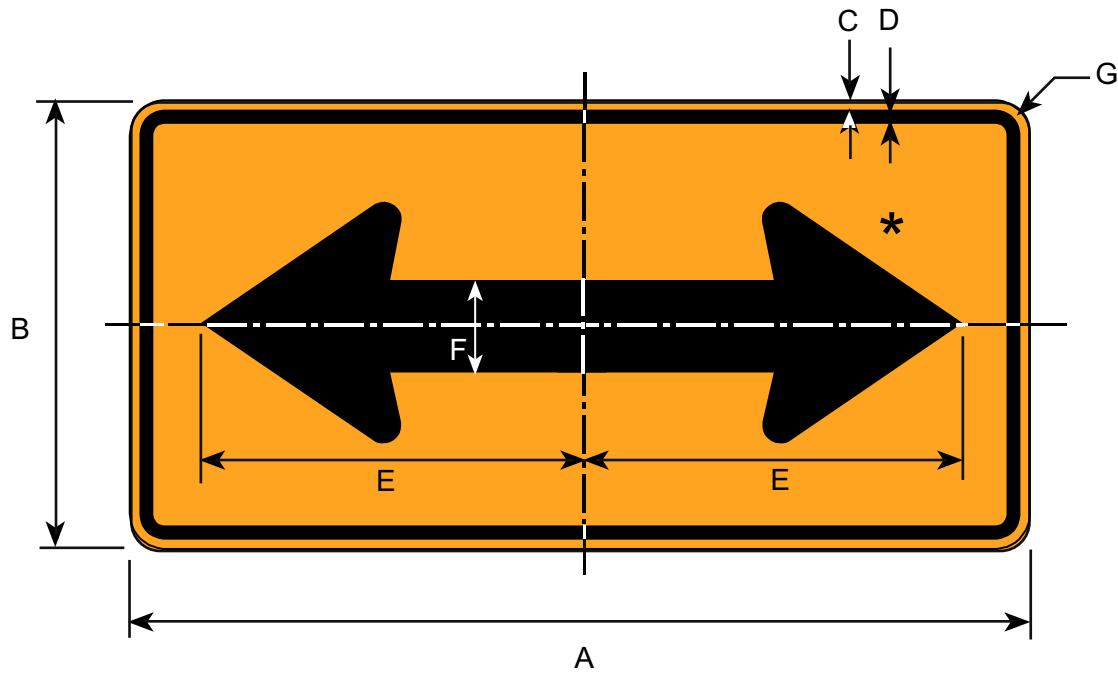

* See Appendix B-1 for Standard Arrow Details.

Border and Legend: Black
Background: Orange

Road Class	Dimensions (inches)						
	A	B	C	D	E	F	G
Bike	24	12	0.38	0.63	10.38	3.25	1.5
Minimum	36	18	0.38	0.63	15.63	5.0	1.5
Conventional	48	24	0.50	0.75	20.5	6.5	1.88
Expwy/Fwy	60	30	0.63	0.88	25.38	8.0	2.25
Oversized	96	48	0.75	1.25	41	12.5	3

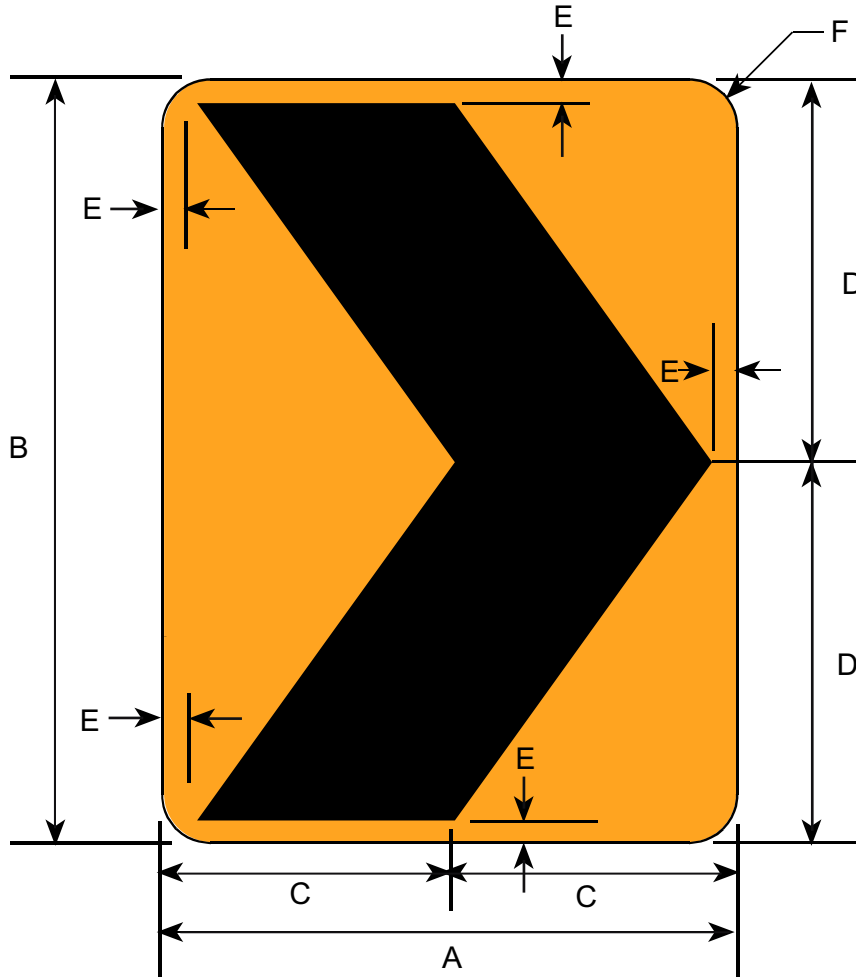

CW1-8R



CW1-8L

Border and Legend: Black
Background: Orange

Road Class	Dimensions (inches)					
	A	B	C	D	E	F
Bike	12	18	6.0	9.0	0.50	1.5
Minimum	18	24	9.0	12	0.75	1.5
Conventional	24	30	12	15	0.88	1.5
Expwy	30	36	15	18	1.0	1.88
Freeway	36	48	18	24	1.13	2.25

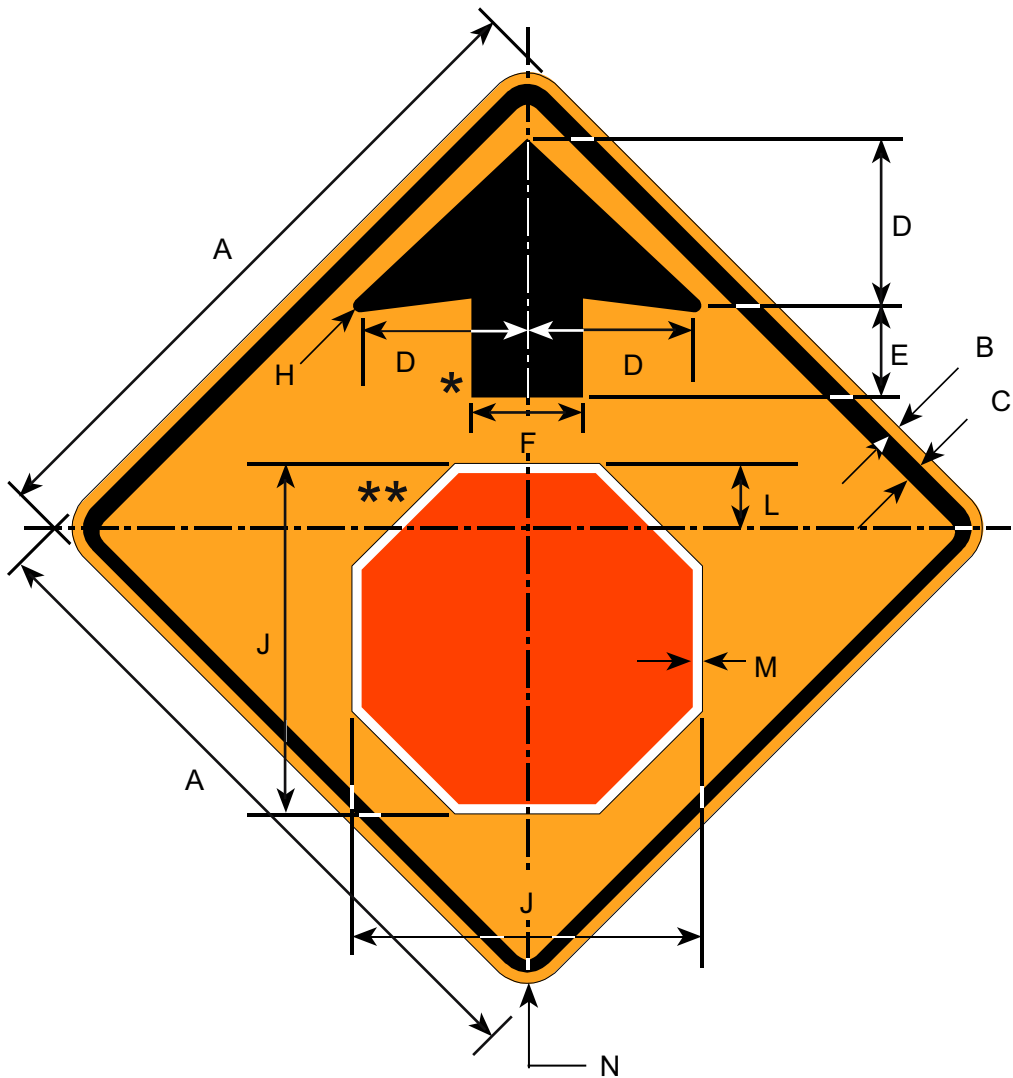

Border and Legend: Black
 Background: Orange
 Symbol: White Border on Red Background

* See Appendix B-3 for Arrow Details.
 ** Make Symbol proportional to graphic shown.

Road Class	Dimensions (inches)										
	A	B	C	D	E	F	H	J	L	M	N
Minimum	30	0.50	0.75	7.5	3.75	5	0.31	15.75	2.88	0.50	1.88
Standard	36	0.63	0.88	9.0	4.5	6	0.38	19	3.5	0.63	2.25
Expwy/Fwy	48	0.75	1.25	12	6.0	8	0.50	25.13	4.5	0.75	3.0

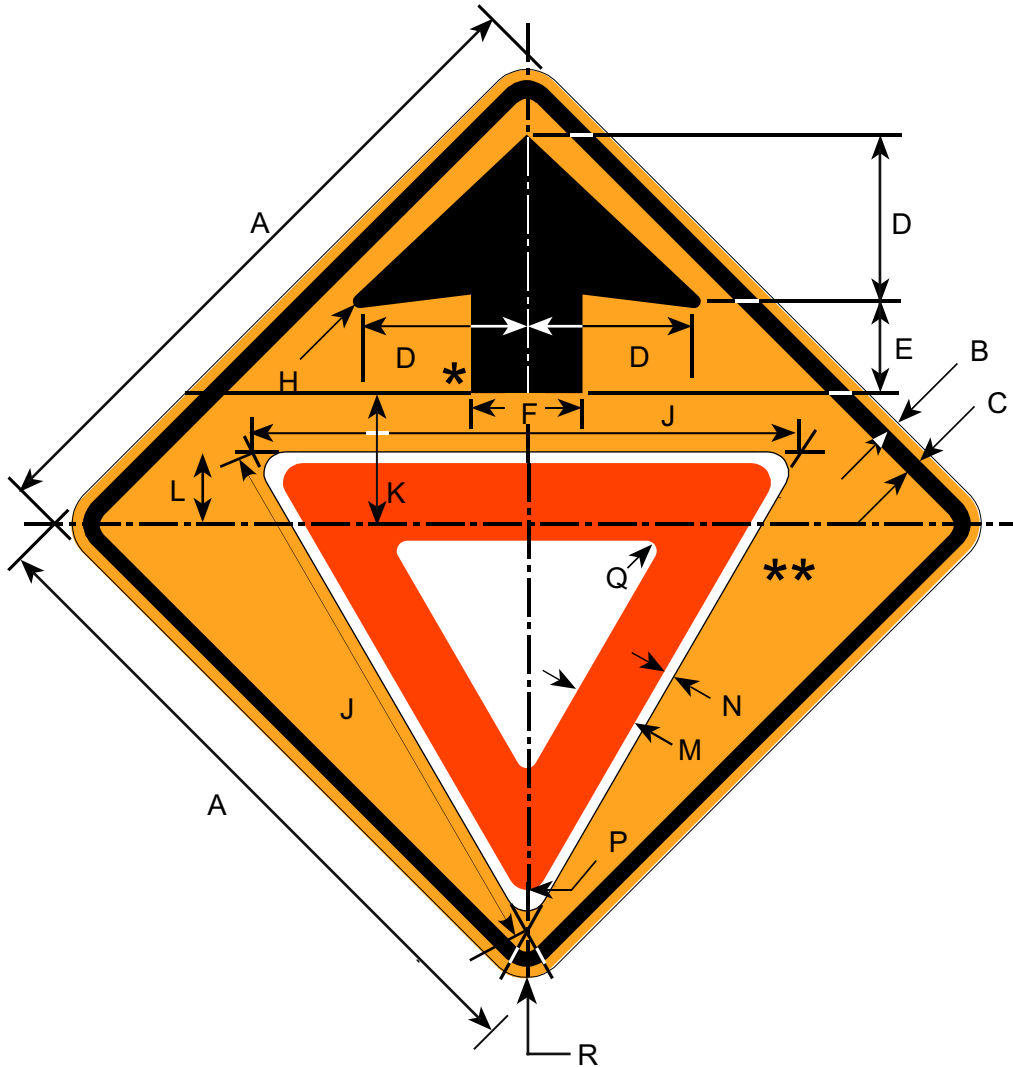

Border and Legend: Black
 Background: Orange
 Symbol: Red Border on White Background

* See Appendix B-3 for Arrow Details.
 ** Make Symbol proportional to graphic shown.

Road Class	Dimensions (inches)														
	A	B	C	D	E	F	H	J	K	L	M	N	P	Q	R
Minimum	30	0.50	0.75	7.5	3.75	5.0	0.31	25	6.25	3.0	3.38	0.50	1.25	0.63	1.88
Conventional	36	0.63	0.88	9.0	4.5	6.0	0.38	28	7.5	3.38	3.75	0.63	1.38	0.75	2.25
Expwy/Fwy	48	0.75	1.25	12	6.0	8.0	0.50	38	10	4.5	5.0	0.75	1.88	1.0	3.0

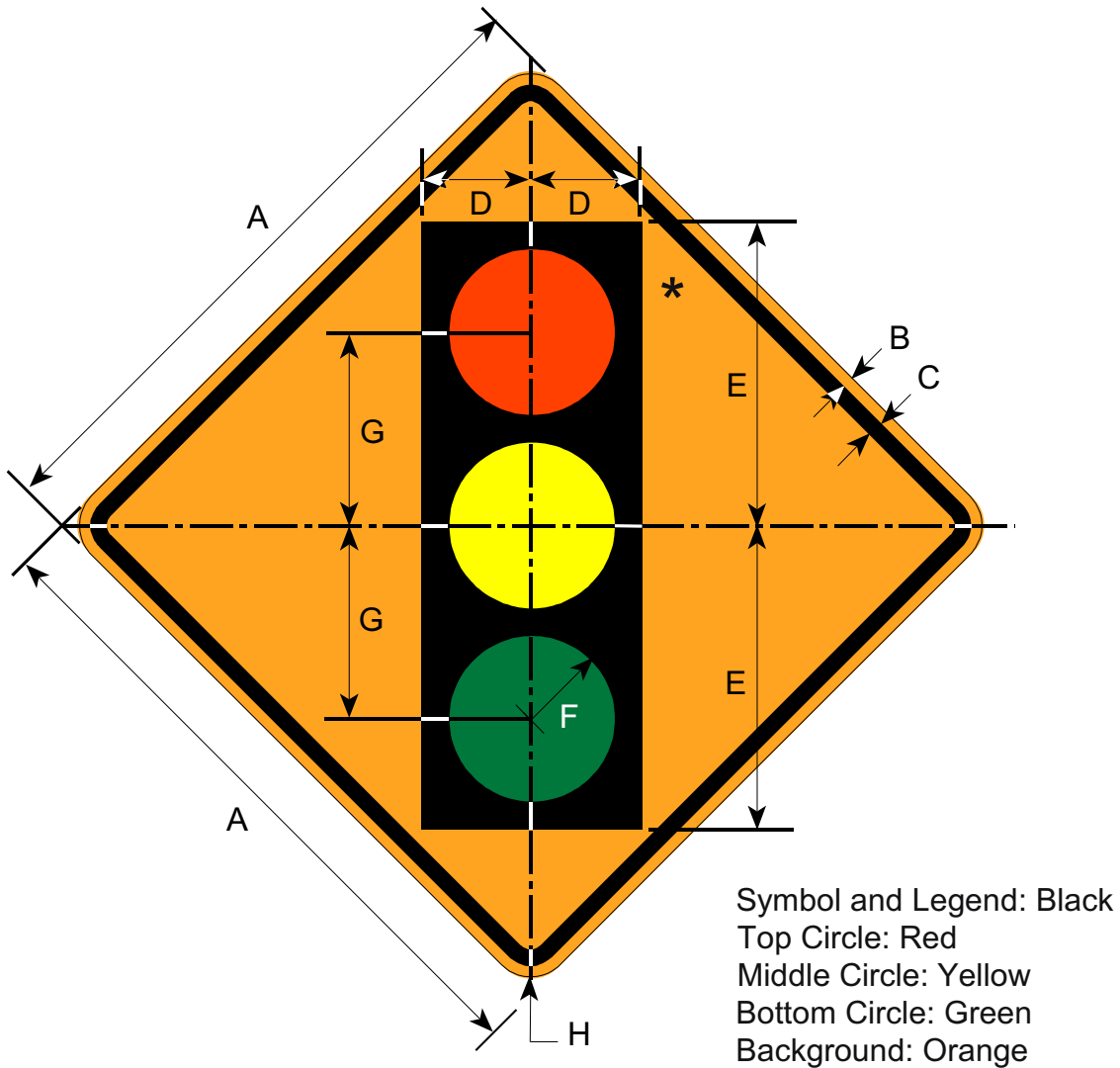

Prior to 2002 publication of this manual, this sign was numbered CW3-3B.

* Make Symbol proportional to graphic shown.

Road Class	Dimensions (inches)							
	A	B	C	D	E	F	G	H
Bike	18	0.38	0.63	3.0	8.0	2.25	5.0	1.50
Minimum	30	0.50	0.75	5.0	13.75	3.75	8.75	1.88
Conventional	36	0.63	0.88	5.75	15.75	4.25	10	2.25
Expwy/Fwy	48	0.75	1.25	7.5	20	5.0	12.5	3.0

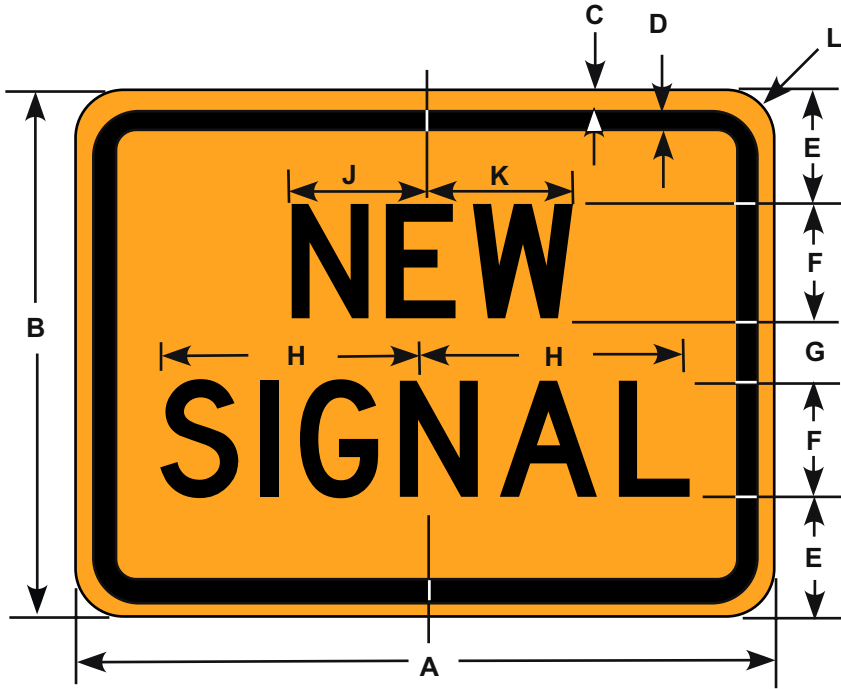

Border and Legend: Black
 Background: Orange

This sign shall be used with CW3-3 Signal Ahead.

Road Class	Dimensions (inches)										
	A	B	C	D	E	F	G	H	J	K	L
Conventional	24	18	0.38	0.63	4	4D	2	9.38	5.06	5	1.50

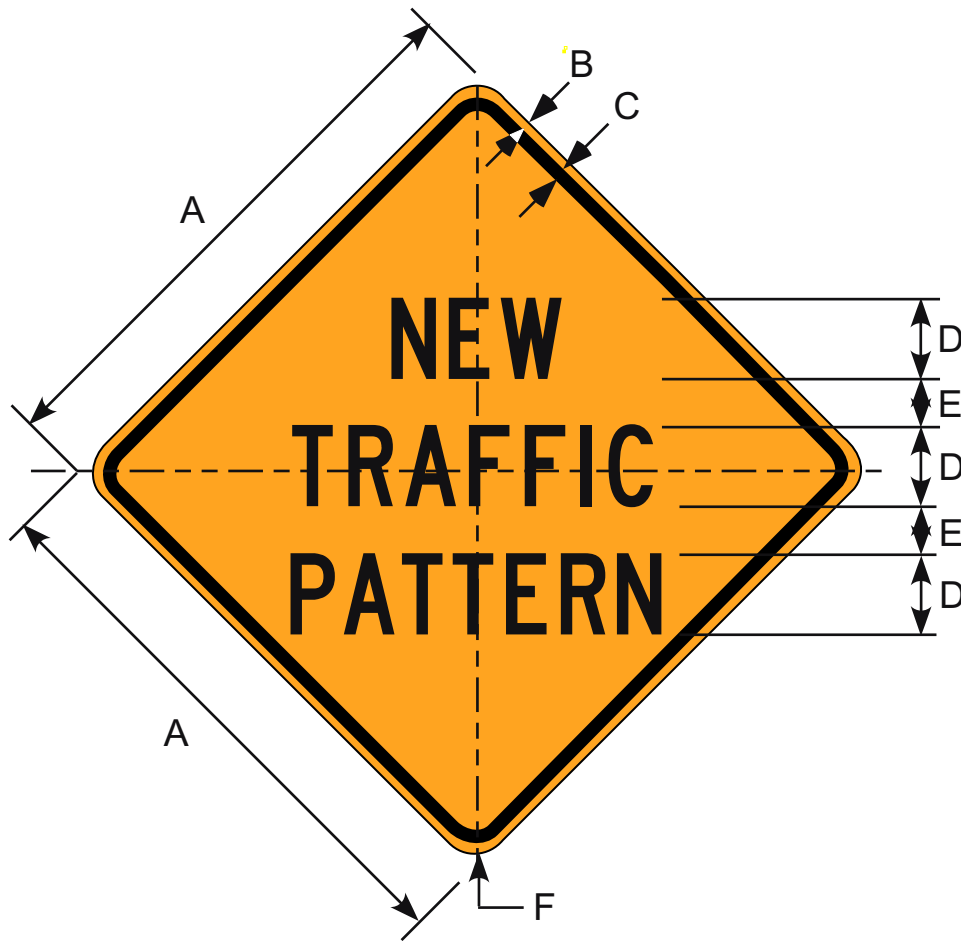

Border and Legend: Black
 Background: Orange

Prior to the 2003 revision of this manual this sign was numbered W3-100.
 This sign replaces former SIGNAL REVISION (CW21-9) and TRAFFIC REVISION (CW21-10) signs.

Road Class	Dimensions (inches)					
	A	B	C	D	E	F
Minimum	30	0.50	0.75	4C	2.5	1.88
Conventional	36	0.63	0.88	5C	3.0	2.25
Expwy/Fwy	48	0.75	1.25	7C	4.0	3.0

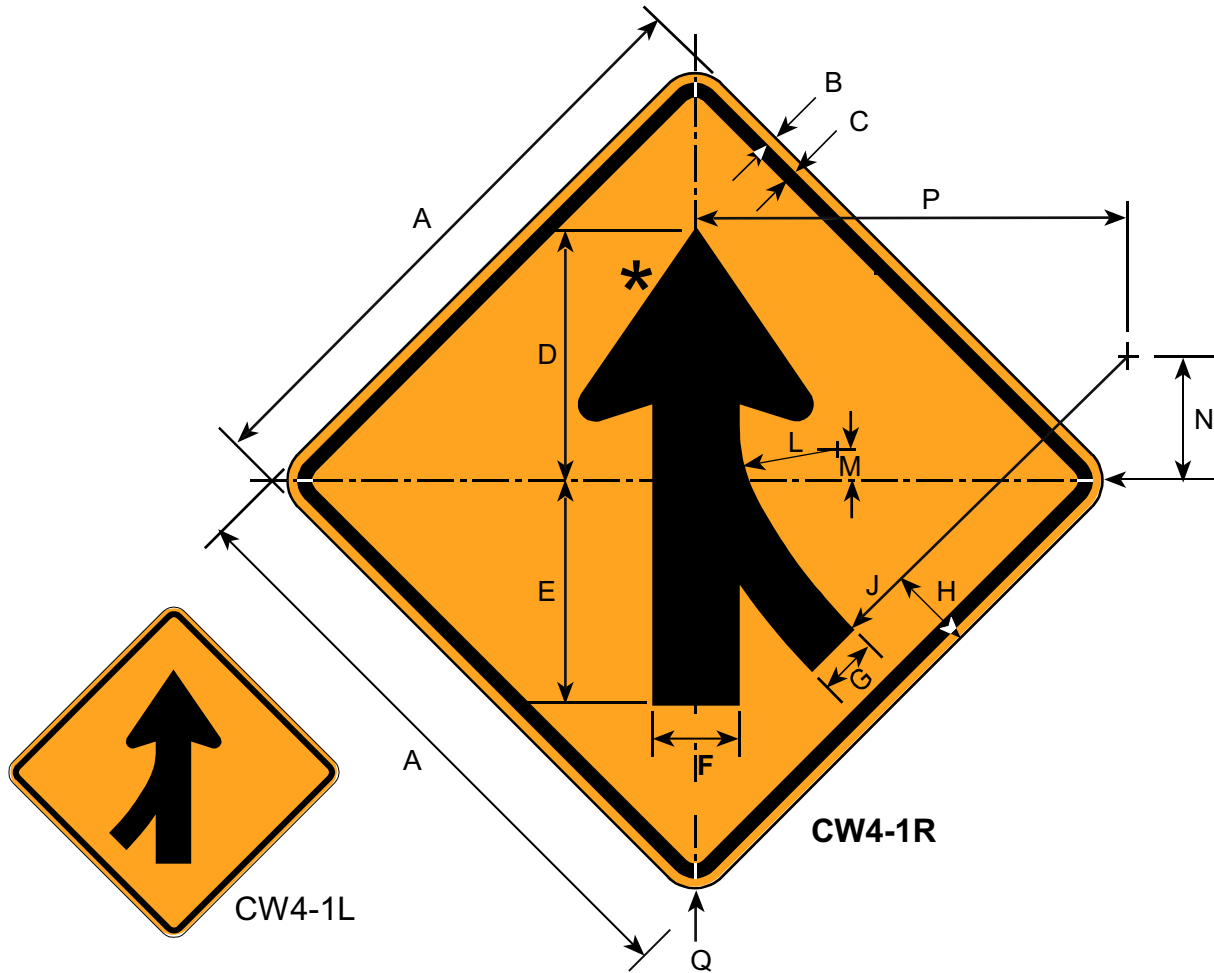

* See Appendix B-1 for Standard Arrow Details.

Border and Legend: Black
Background: Orange

Road Class	Dimensions (inches)													
	A	B	C	D	E	F	G	H	J	L	M	N	P	Q
Minimum	30	0.50	0.75	13	11	4.38	3.0	5.25	28	8.0	3.0	13	27.75	1.88
Conventional	36	0.63	0.88	15.75	13.25	5.25	3.63	6.31	33.63	9.63	4.0	15.63	35.31	2.25
Expwy/Fwy	48	0.75	1.25	20.5	17.5	7.0	4.75	8.38	45	12.81	5.25	20.75	44.38	3.0

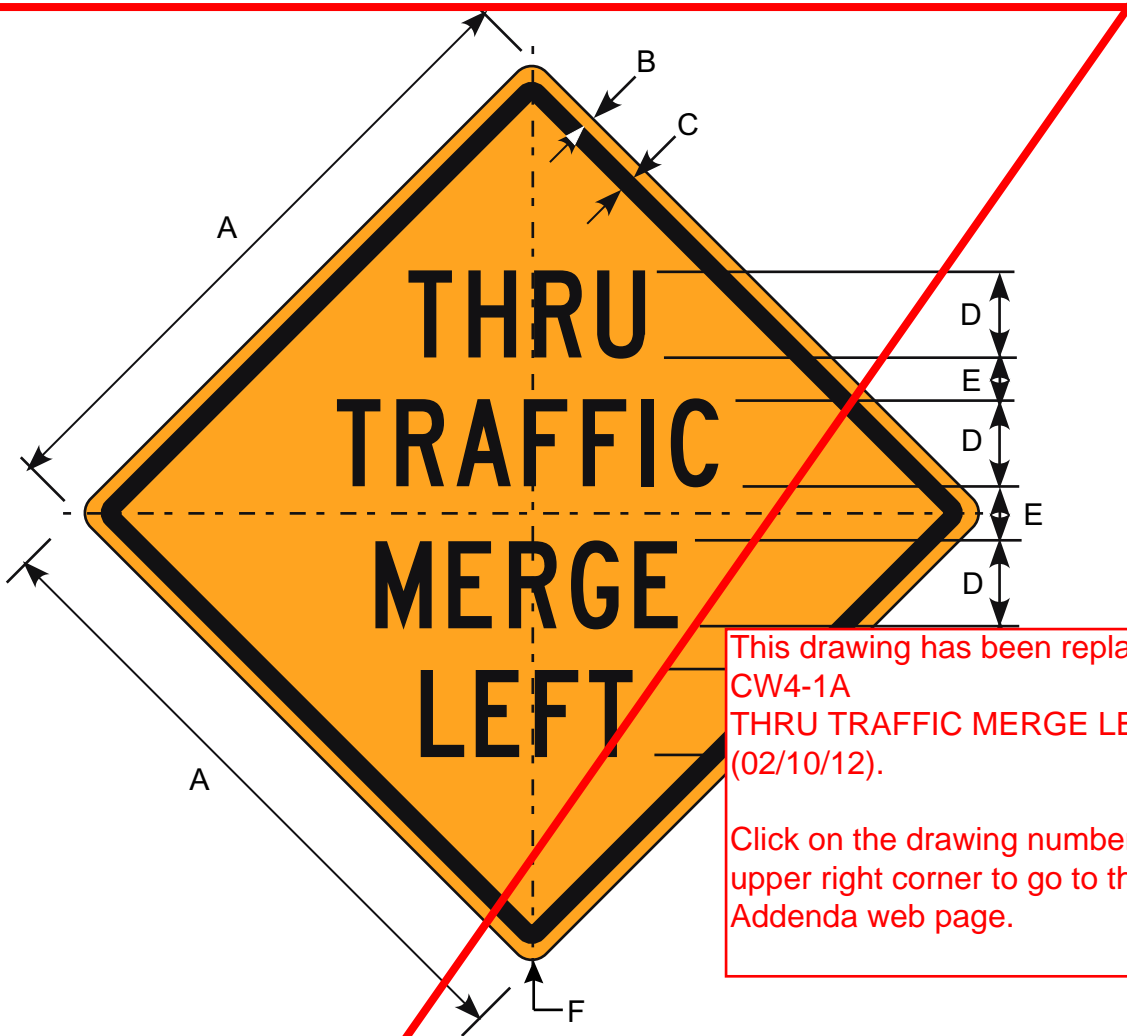

This drawing has been replaced with:
CW4-1A
THRU TRAFFIC MERGE LEFT
 (02/10/12).

Click on the drawing number in the upper right corner to go to the Interim Addenda web page.

Border and Legend: Black
 Background: Orange

Road Class	Dimensions (inches)					
	A	B	C	D	E	F
Minimum	36	0.63	0.88	5C	2.5	2.25
Conventional	48	0.75	1.25	6C	3.0	3.0
Expwy/Fwy	60	1.0	1.5	8C	4.0	3.75

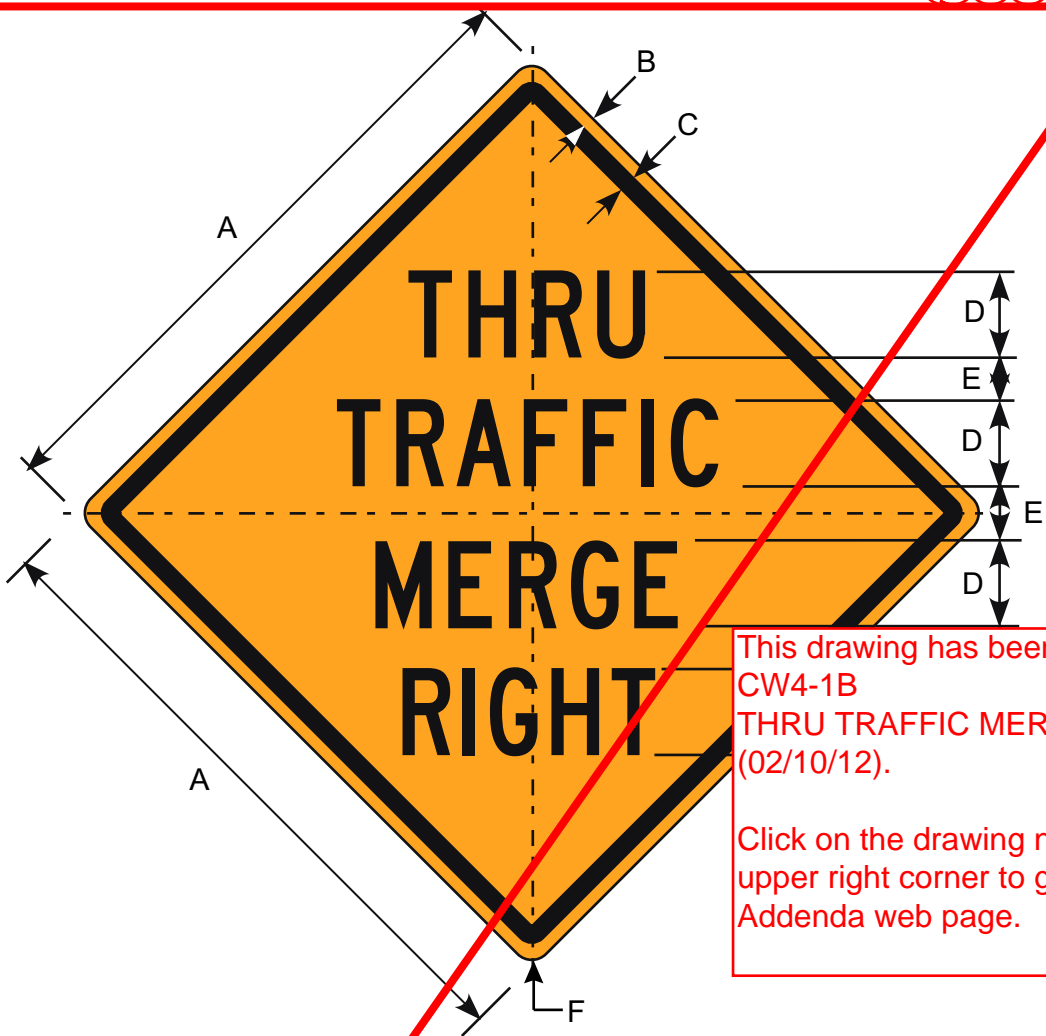

This drawing has been replaced with:
CW4-1B
THRU TRAFFIC MERGE RIGHT
 (02/10/12).

Click on the drawing number in the upper right corner to go to the Interim Addenda web page.

Border and Legend: Black
 Background: Orange

Road Class	Dimensions (inches)					
	A	B	C	D	E	F
Minimum	36	0.63	0.88	5C	2.5	2.25
Conventional	48	0.75	1.25	6C	3.0	3.0
Expwy/Fwy	60	1.0	1.5	8C	4.0	3.75

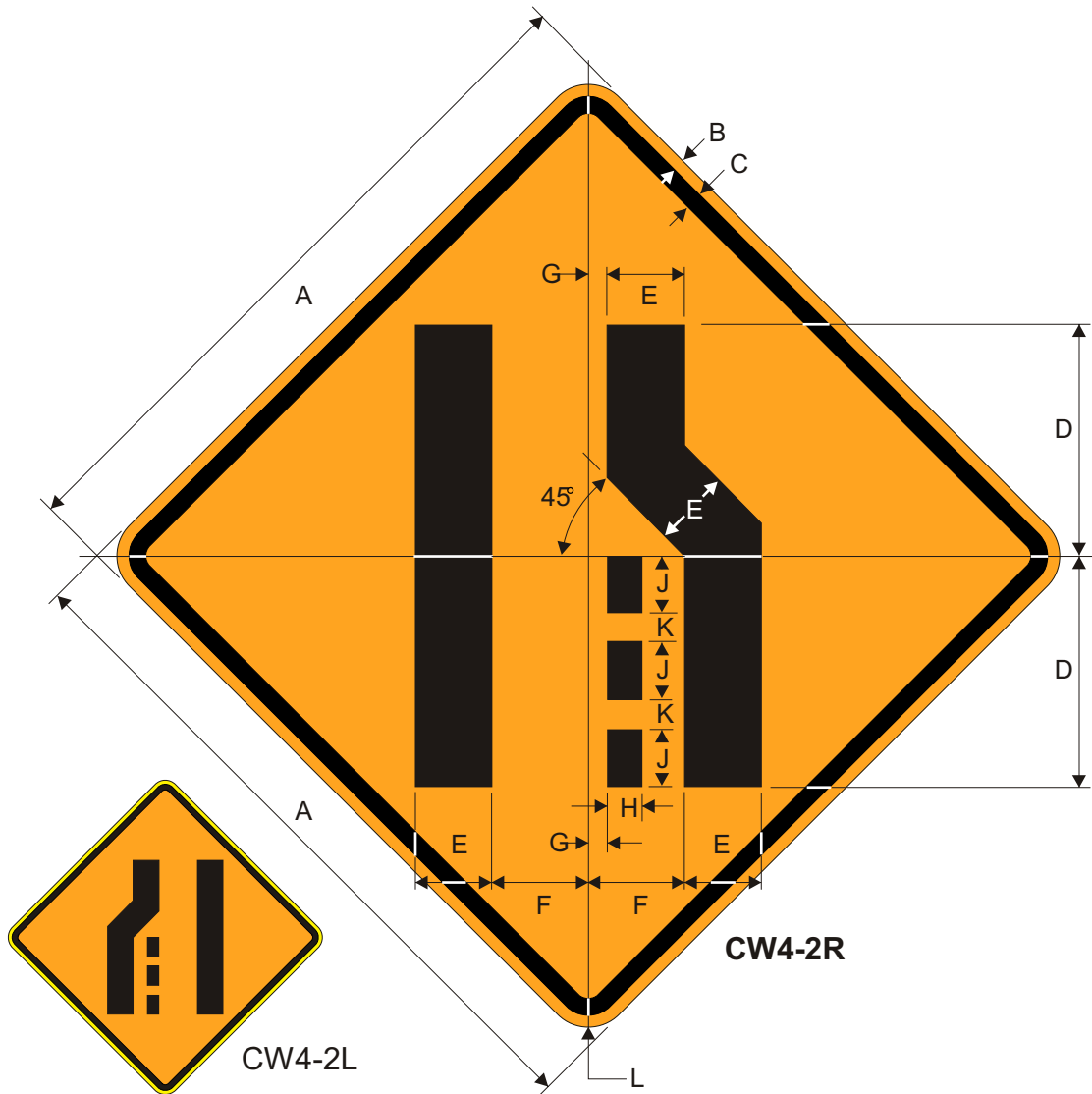

Border and Legend: Black
Background: Orange

Road Class	Dimensions (inches)										
	A	B	C	D	E	F	G	H	J	K	L
Minimum	30	0.5	0.75	10	3.38	4.19	0.88	1.5	2.5	1.25	1.88
Conventional	36	0.63	0.88	12	4.0	5.0	1.0	1.75	3.0	1.5	2.25
Expy/Fwy	48	0.75	1.25	16	5.38	6.69	1.25	2.38	4.0	2.0	3.0

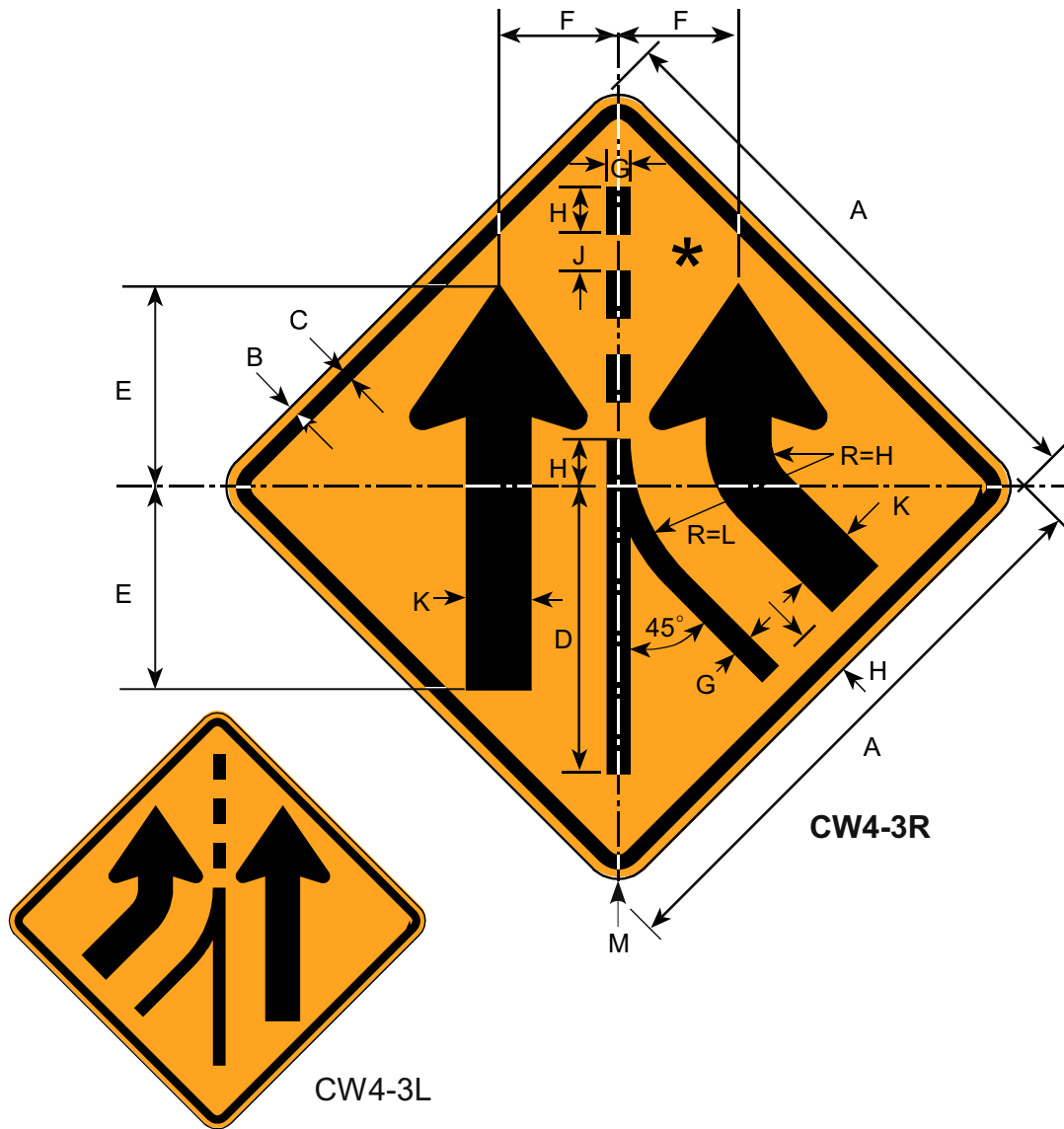

* See Appendix B-1 for Standard Arrow Details.

Border and Legend: Black
Background: Orange

Road Class	Dimensions (inches)											
	A	B	C	D	E	F	G	H	J	K	L	M
Expwy/Fwy	48	0.75	1.25	24	17	10	2.0	4.0	3.0	5.5	15.75	3.0

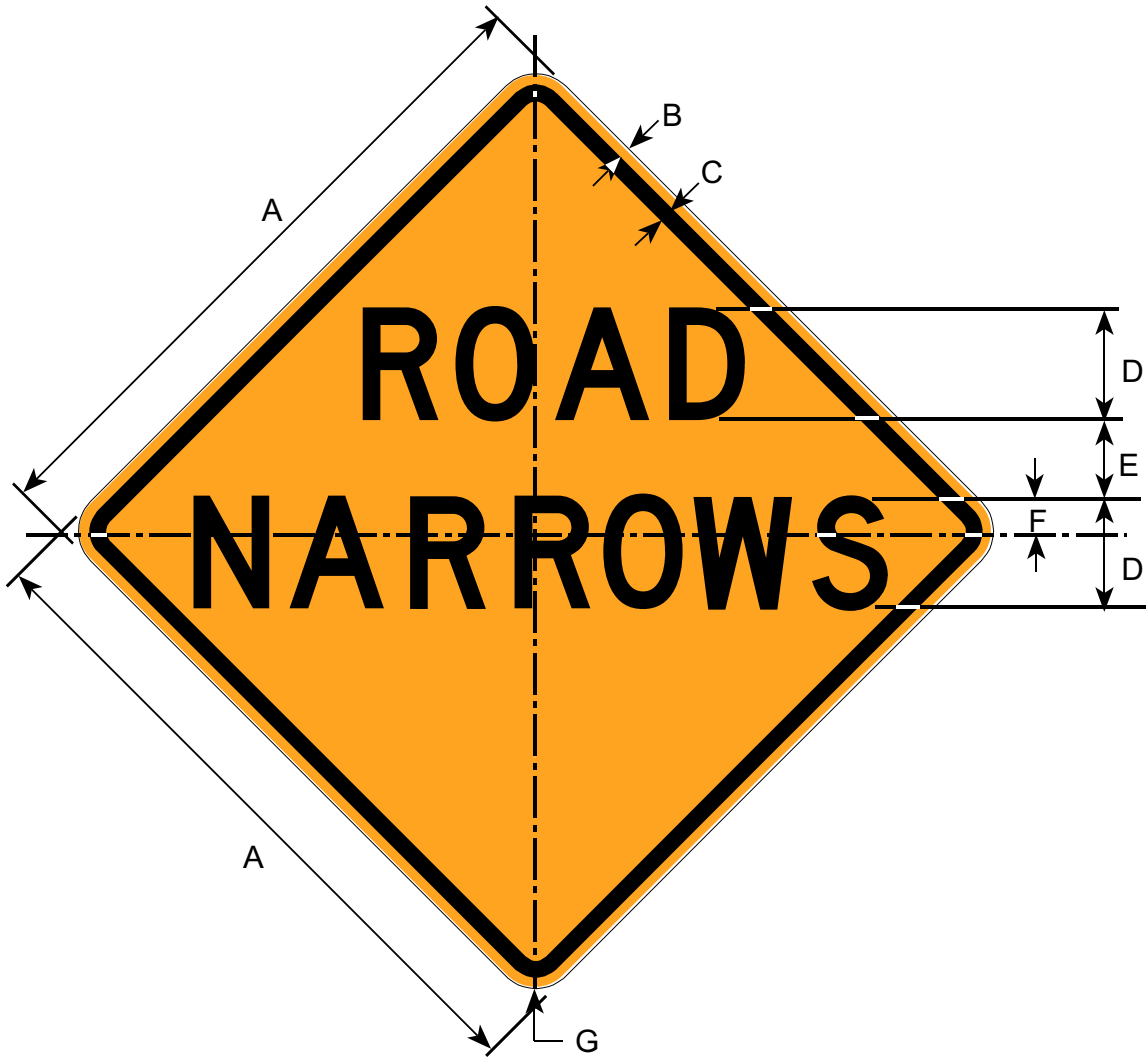

Border and Legend: Black
 Background: Orange

Road Class	Dimensions (inches)						
	A	B	C	D	E	F	G
Minimum	30	0.50	0.75	5D	3.0	1.75	1.88
Conventional	36	0.63	0.88	6D	3.5	2.0	2.25
Expwy/Fwy	48	0.75	1.25	8D	4.0	3.0	3.0

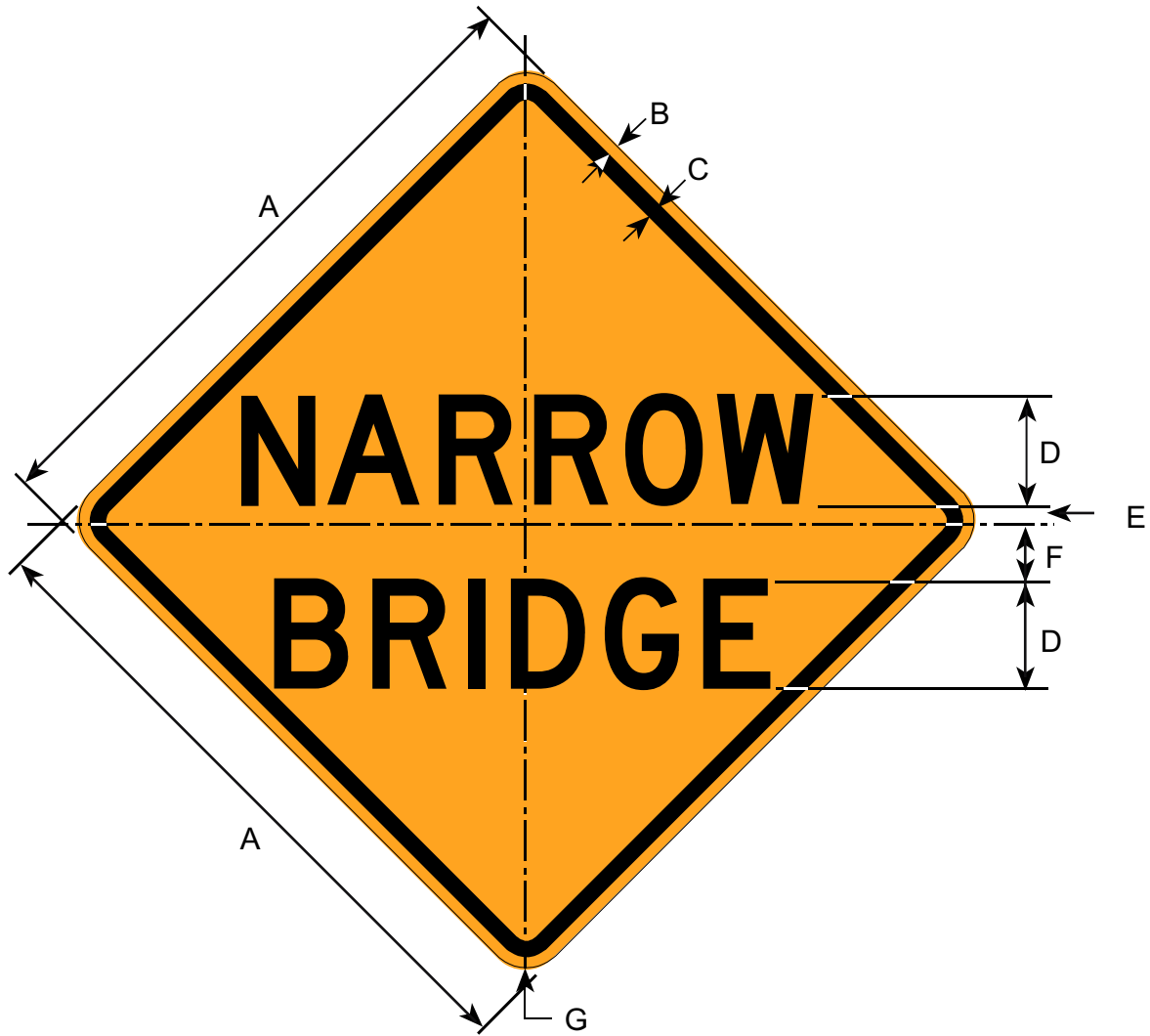

Border and Legend: Black
Background: Orange

Road Class	Dimensions (inches)						
	A	B	C	D	E	F	G
Minimum	30	0.50	0.75	5D	0.50	2.5	1.88
Conventional	36	0.63	0.88	6D	0.75	3.0	2.25
Expwy/Fwy	48	0.75	1.25	8C	2.0	3.3	3.0

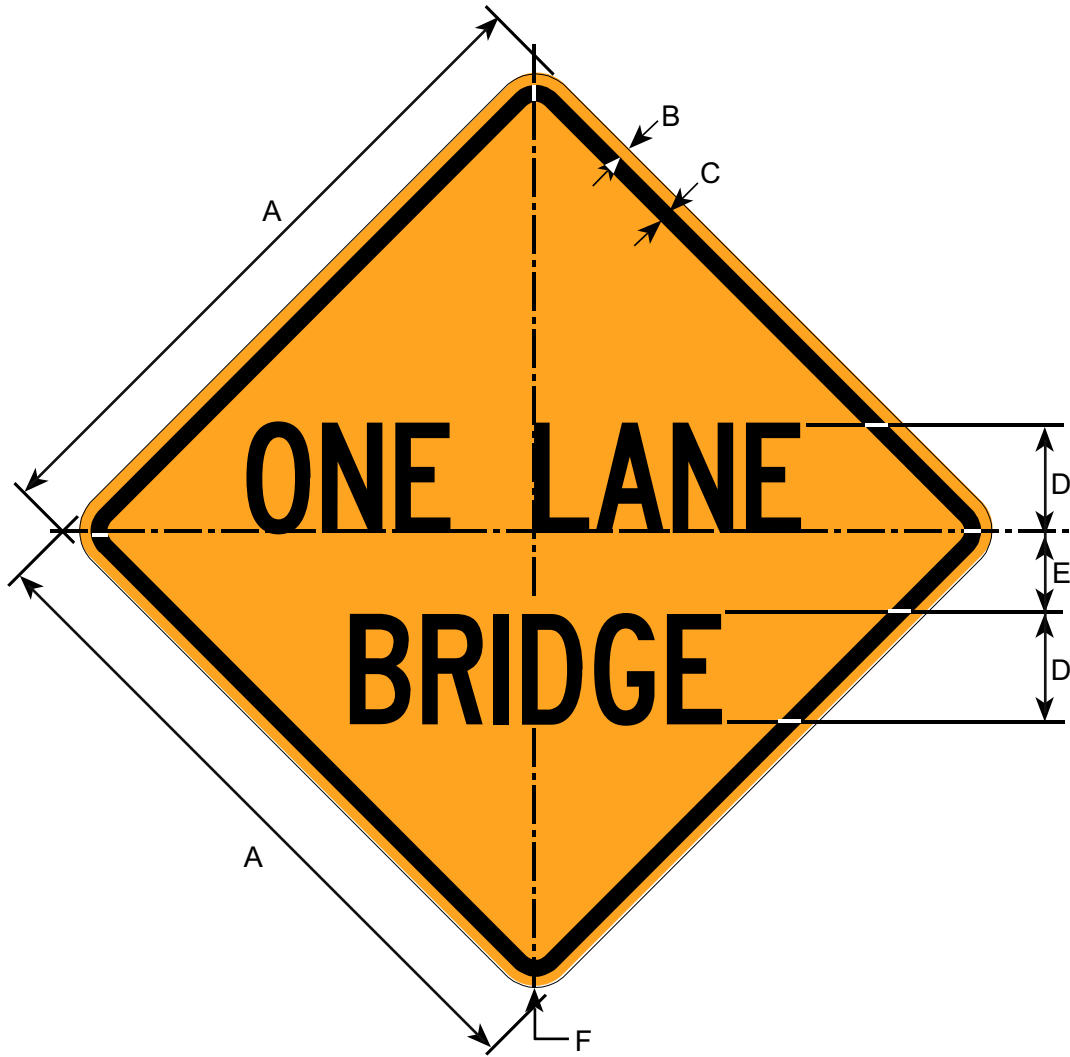

Border and Legend: Black
Background: Orange

Road Class	Dimensions (inches)					
	A	B	C	D	E	F
Minimum	30	0.50	0.75	5C	3.25	1.88
Conventional	36	0.63	0.88	6C	4.00	2.25
Expwy/Fwy	48	0.75	1.25	8C	5.00	3.00

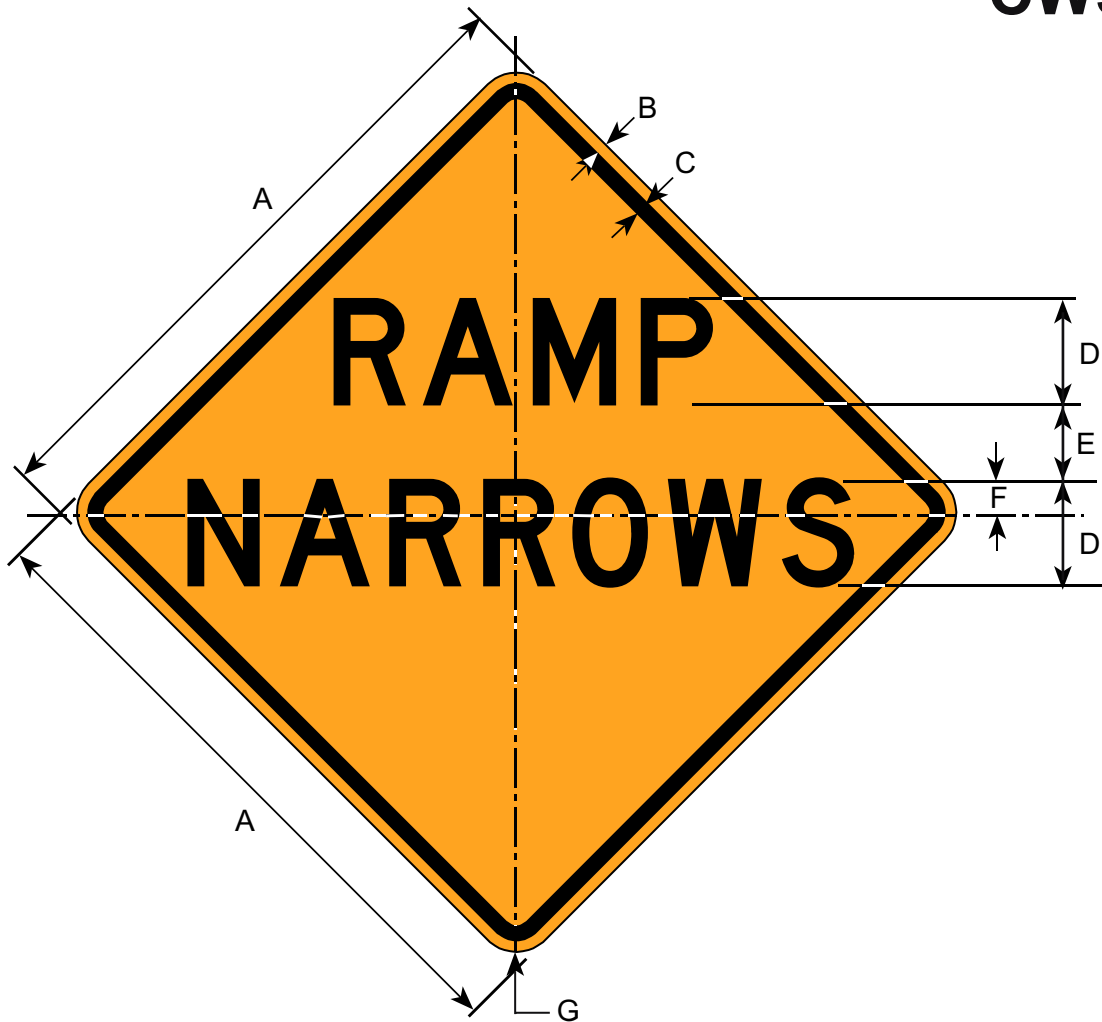

Border and Legend: Black
 Background: Orange

Road Class	Dimensions (inches)						
	A	B	C	D	E	F	G
Minimum	30	0.50	0.75	5D	3.0	1.75	1.88
Conventional	36	0.63	0.88	6D	3.50	2.0	2.50
Expwy/Fwy	48	0.75	1.25	8D	4.0	3.0	3.0

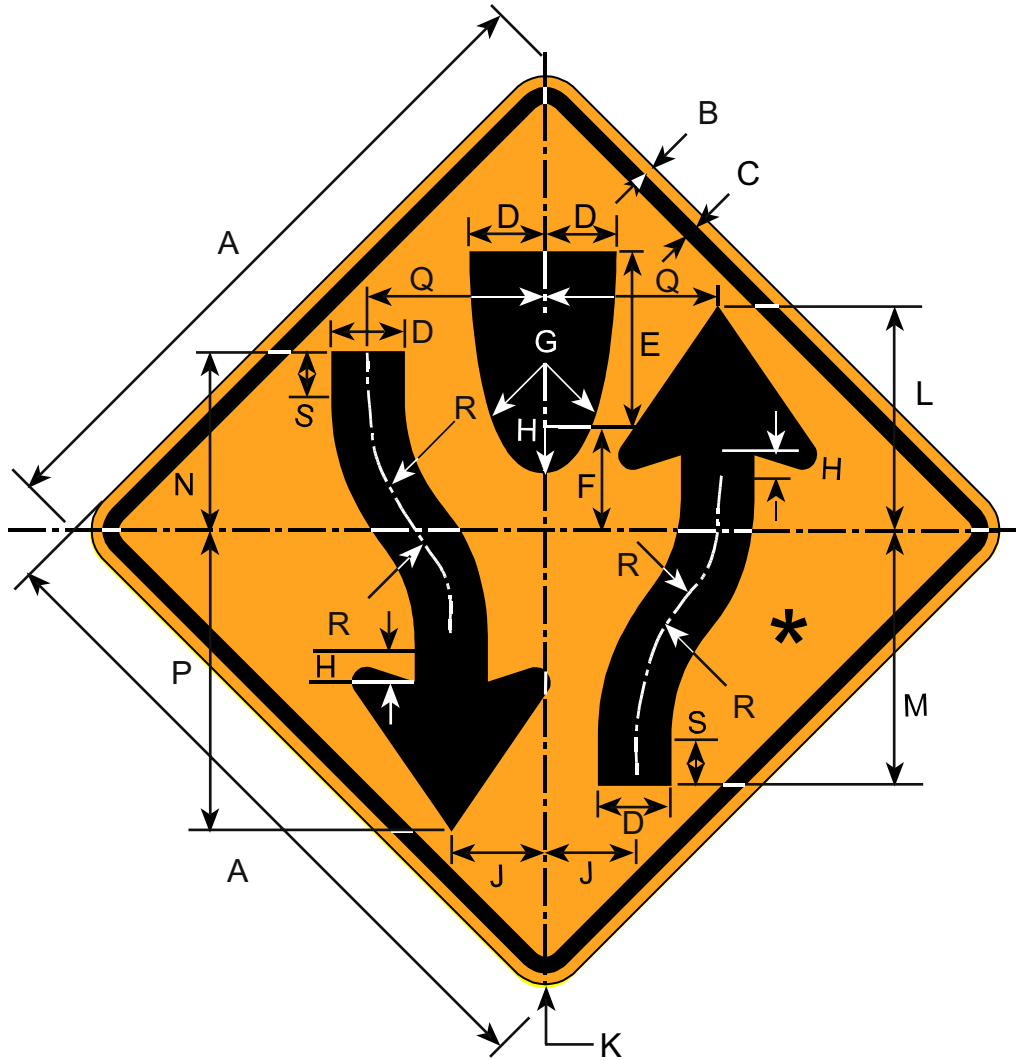

Border and Legend: Black
Background: Orange

* See Appendix B-1 for
Standard Arrow Details.

Road Class	Dimensions (inches)										
	A	B	C	D	E	F	G	H	J	K	L
Minimum	30	0.50	0.75	3.31	8.31	4.13	25	1.69	4.13	1.88	10
Conventional	36	0.63	0.88	4.0	10	5.0	30	2.0	5.0	2.25	12
Expwy/Fwy	48	0.75	1.25	5.25	13.13	6.56	39.31	2.63	6.56	3.0	16

M	N	P	Q	R	S
11.63	7.94	13.69	7.88	8.31	2.06
14	9.5	16.5	9.5	10	2.5
18.69	12.69	22	12.44	13.13	3.31

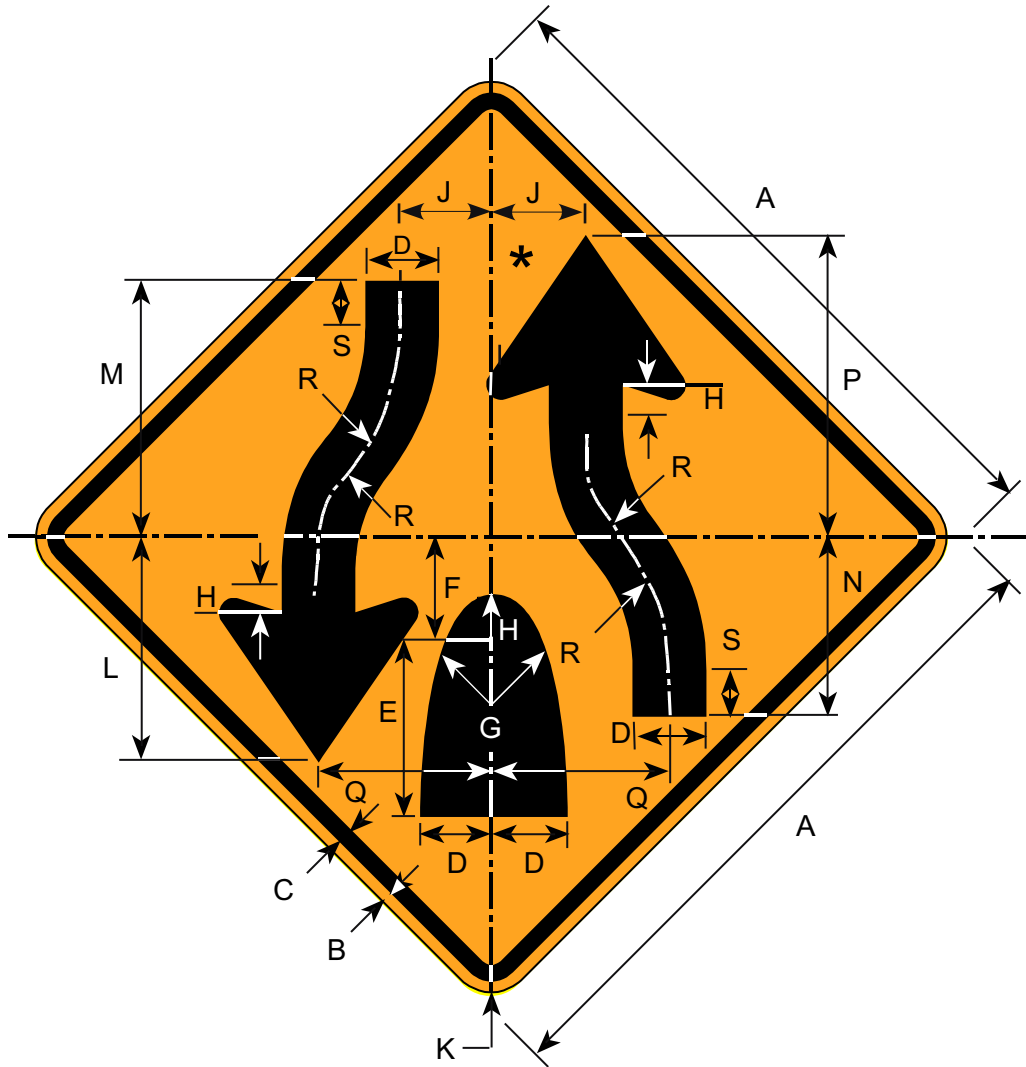

* See Appendix B-1 for Standard Arrow Details.

Border and Legend: Black
Background: Orange

Road Class	Dimensions (inches)										
	A	B	C	D	E	F	G	H	J	K	L
Minimum	30	0.50	0.75	3.31	8.31	4.13	25	1.69	4.13	1.88	10
Conventional	36	0.63	0.88	4.0	10	5.0	30	2.0	5.0	2.25	12
Expwy/Fwy	48	0.75	1.25	5.25	13.13	6.56	39.31	2.63	6.56	3.0	16

M	N	O	P	Q	R	S
11.63	7.94	7.88	13	7.88	8.31	2.06
14	9.50	9.5	16.5	9.5	10	2.5
18.69	12.69	12.69	22	12.44	13.13	3.31

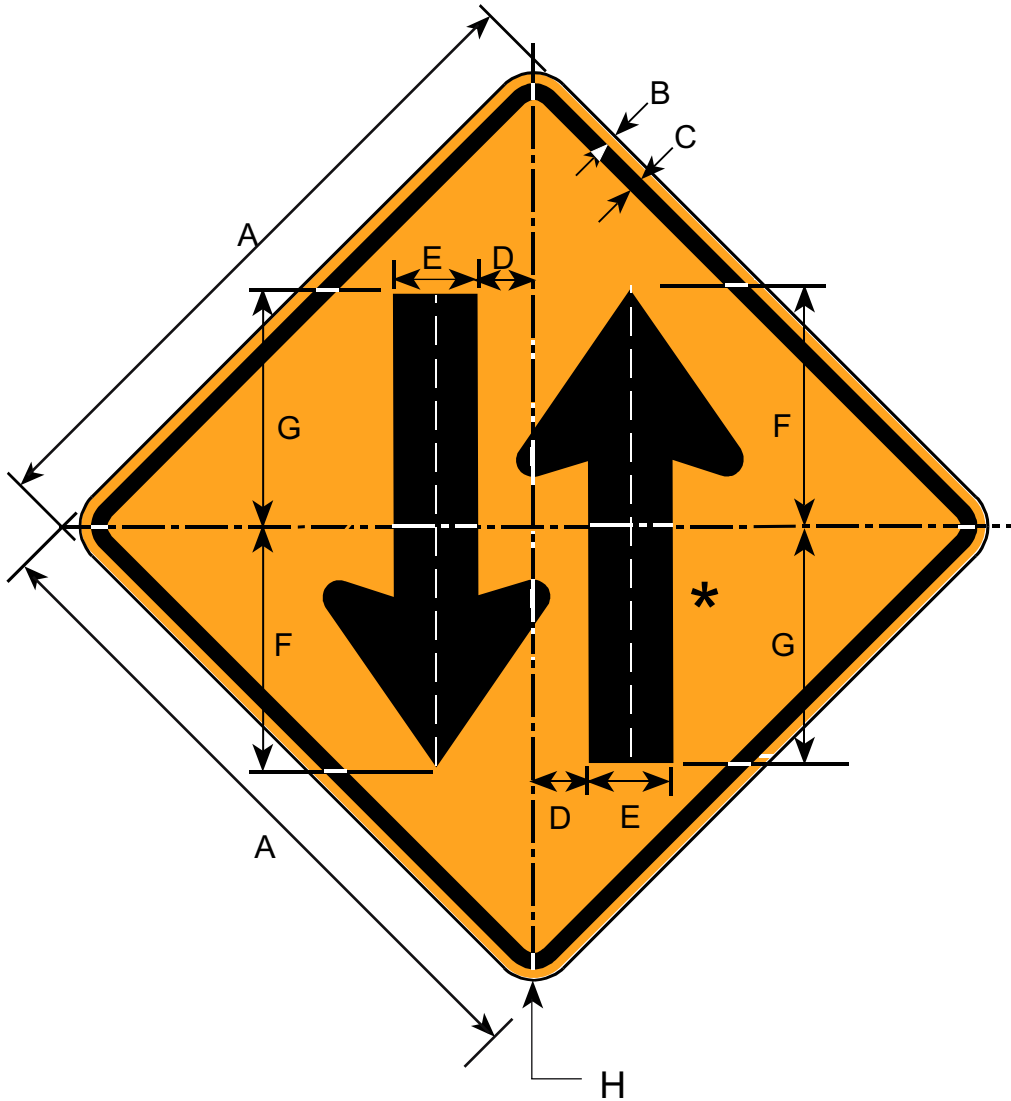

* See Appendix B-1 for Standard Arrow Details.

Border and Legend: Black
Background: Orange

Road Class	Dimensions (inches)							
	A	B	C	D	E	F	G	H
Minimum	30	0.50	0.75	2.44	3.75	11.25	10.63	1.88
Conventional	36	0.63	0.88	2.94	4.5	13.5	12.75	2.25
Expwy/Fwy	48	0.75	1.25	3.88	6.0	18	17	3.0

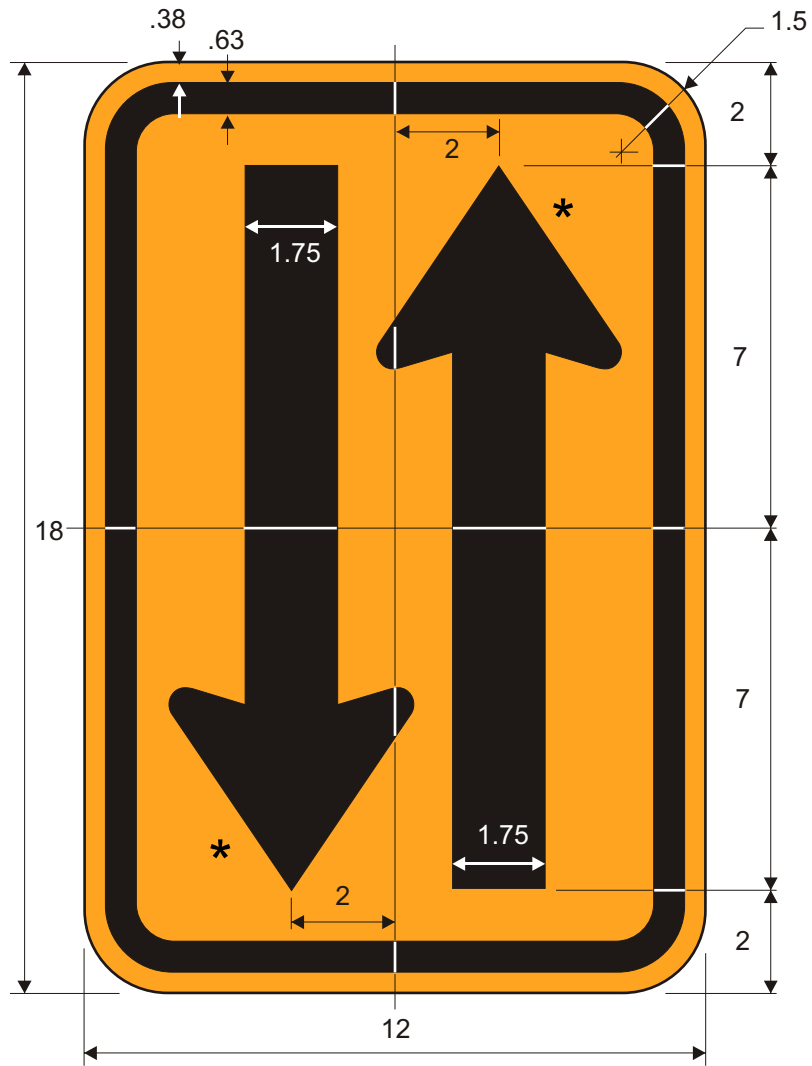

* See Appendix B-1 for
Standard Arrow Details.

Border and Legend: Black
Background: Orange

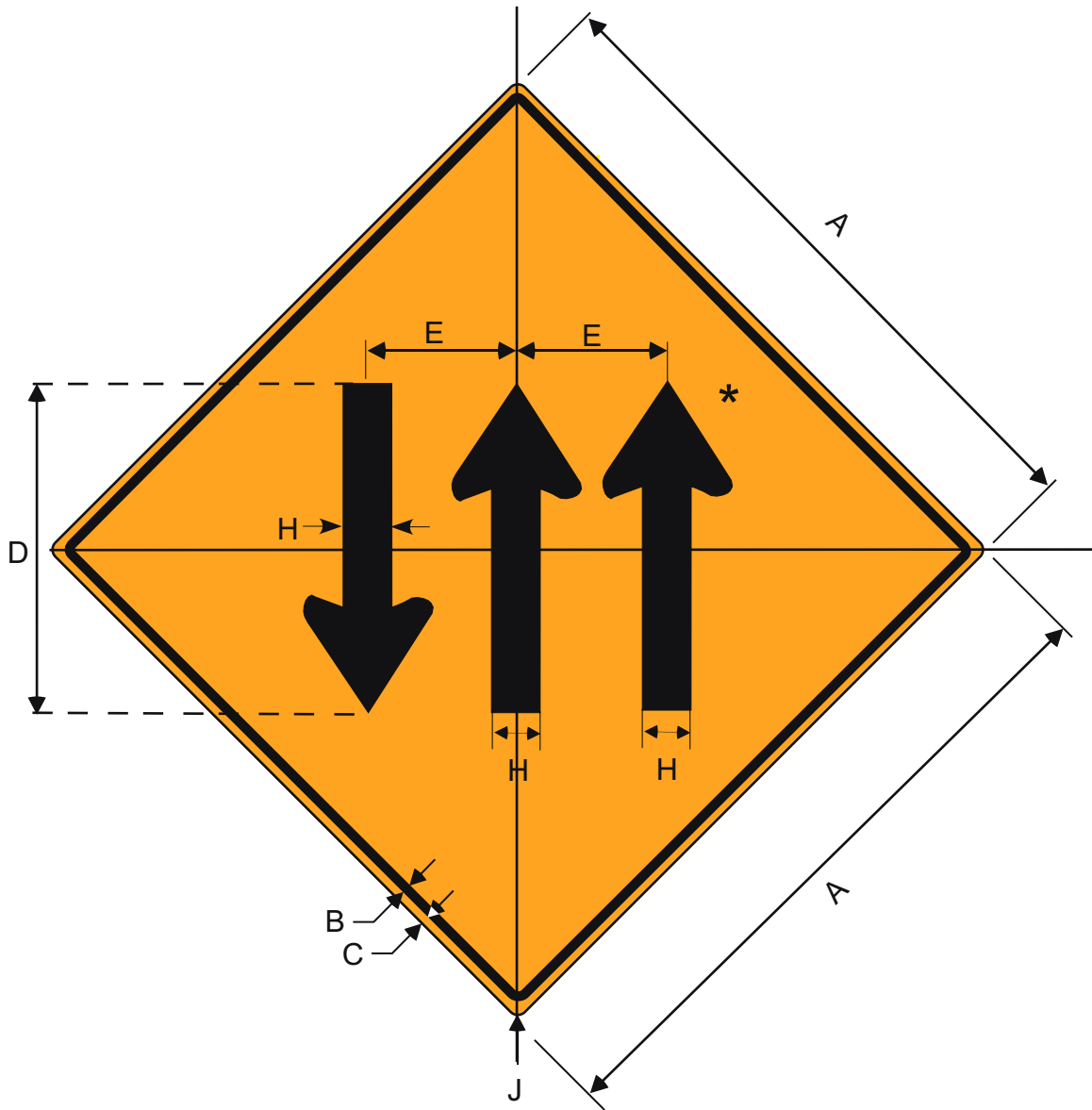

* See Appendix B-1 for Standard Arrow Details.

Border and Legend: Black
Background: Orange

Road Class	Dimensions (inches)									
	A	B	C	D	E	F	G	H	J	
Conventional	36	0.63	0.88	22	8.0	5.56	6.0	2.75	2.25	
Expwy/Fwy	48	0.75	1.25	30	11	7.13	8.0	3.5	3.0	

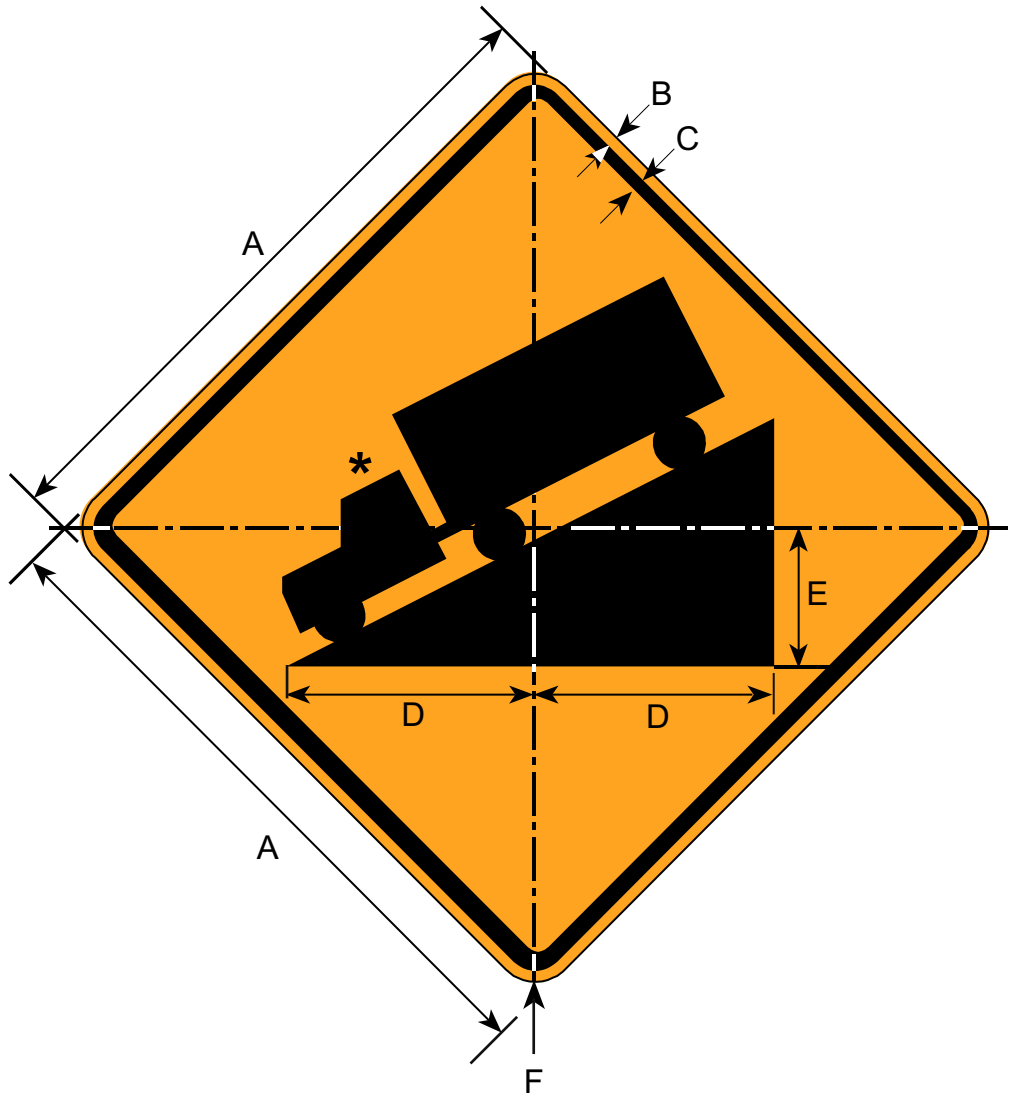

*Make symbol proportional to the graphic shown.

Border and Legend: Black
Background: Orange

Road Class	Dimensions (inches)					
	A	B	C	D	E	F
Minimum	30	0.50	0.75	11	7.50	1.88
Conventional	36	0.63	0.88	13.25	9.0	2.25
Expwy/Fwy	48	0.75	1.25	17.5	12	3.0

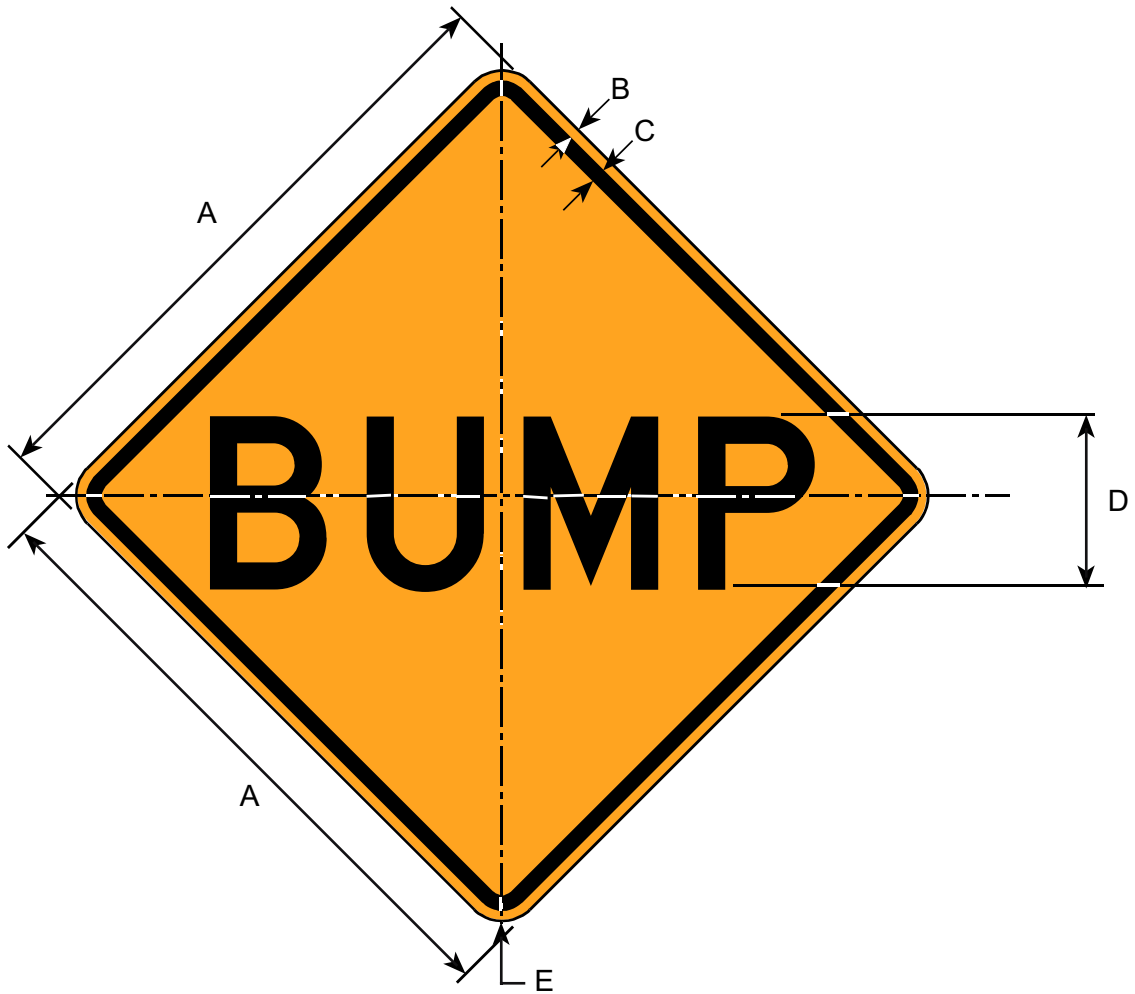

Border and Legend: Black
 Background: Orange

Road Class	Dimensions (inches)				
	A	B	C	D	E
Minimum	30	0.50	0.75	8D	1.88
Conventional	36	0.63	0.88	10D	2.25
Expwy/Fwy	48	0.75	1.25	12D	3.0

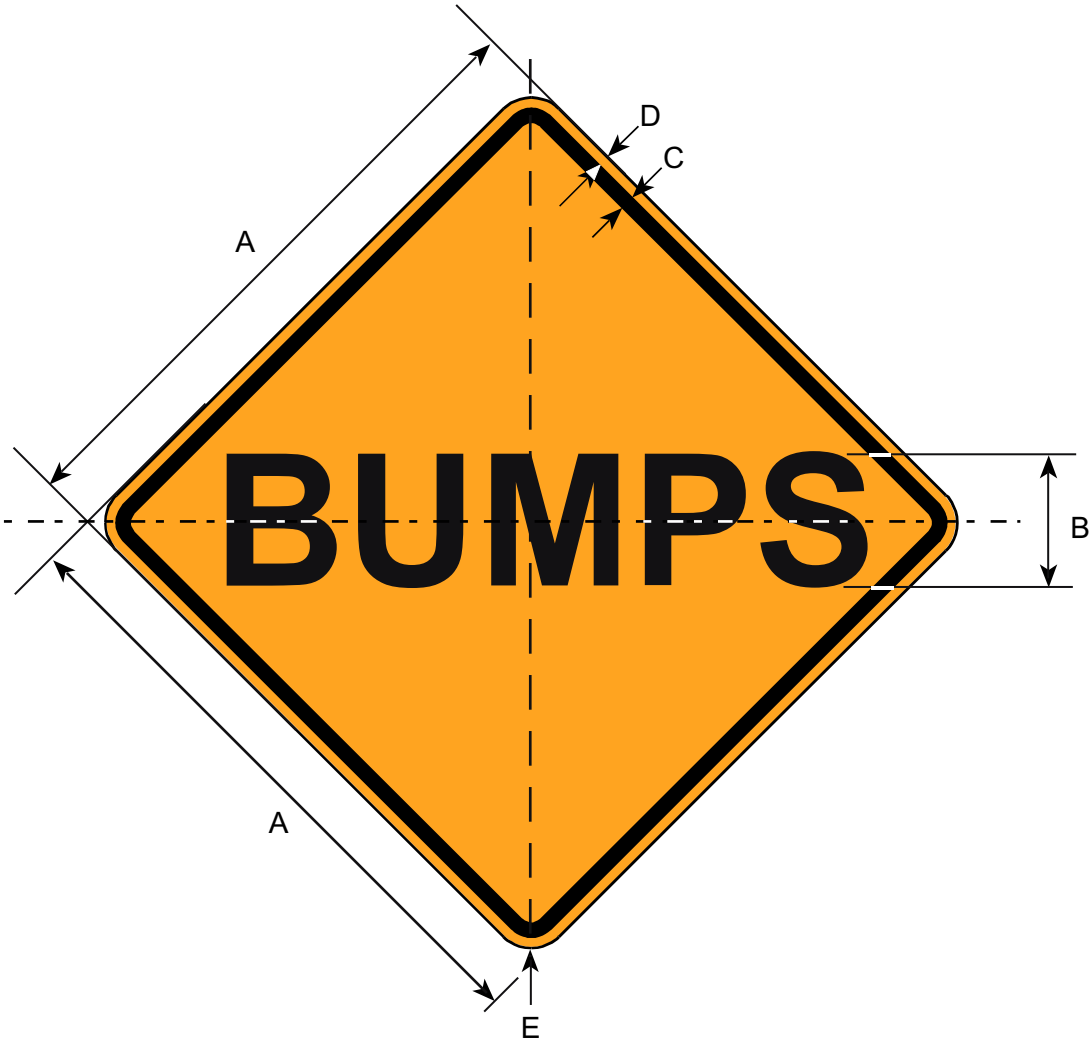

Border and Legend: Black
Background: Orange

Road Class	Dimensions (inches)				
	A	B	C	D	E
Minimum	30	6D	0.75	1.25	1.88
Conventional	36	8D	0.88	1.50	2.25
Expwy/Fwy	48	10D	1.25	2.0	3.0

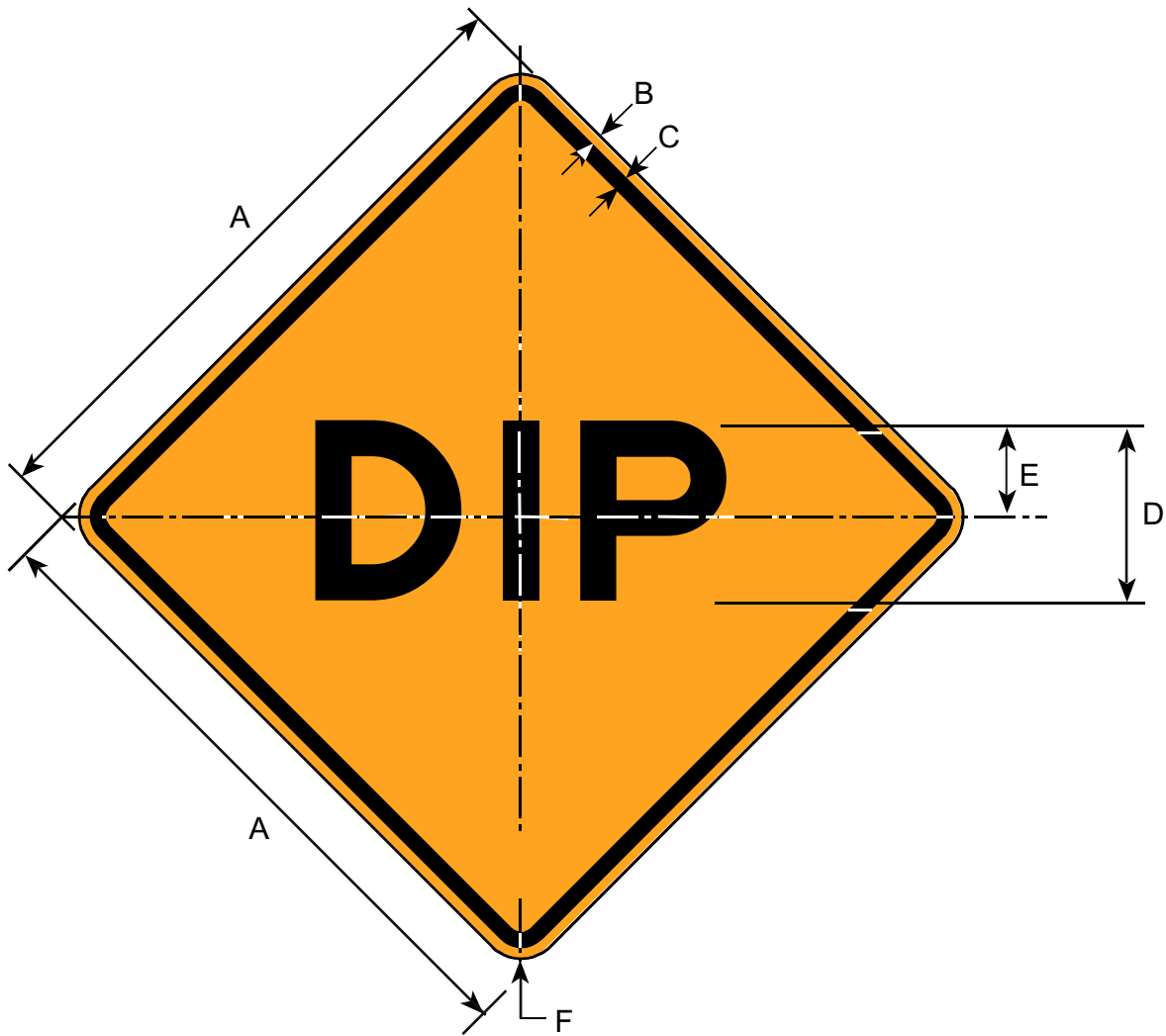

Border and Legend: Black
Background: Orange

Road Class	Dimensions (inches)					
	A	B	C	D	E	F
Minimum	30	0.50	0.75	8E	4.0	1.88
Conventional	36	0.63	0.88	10E	5.0	2.25
Expwy/Fwy	48	0.75	1.25	12E	6.0	3.0

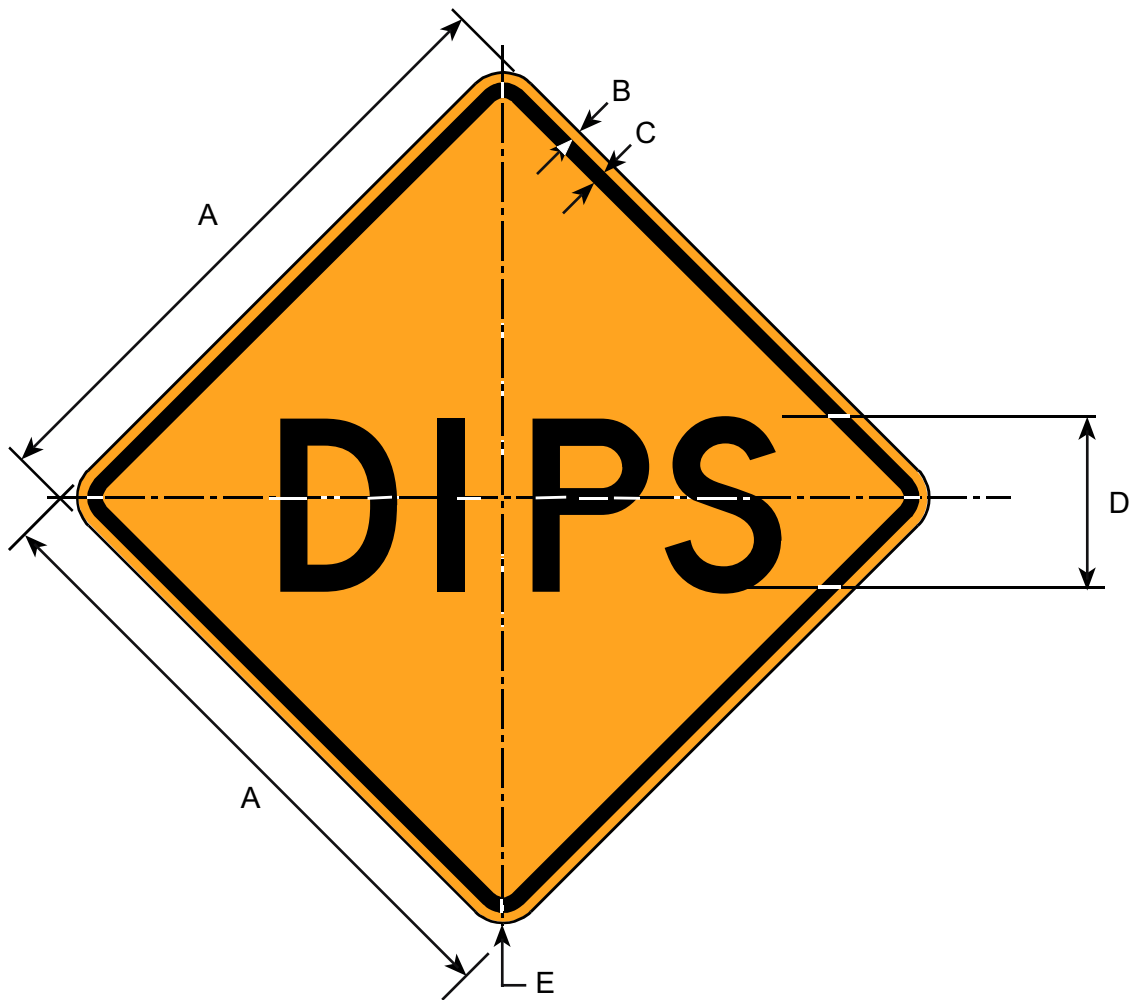

Border and Legend: Black
Background: Orange

Road Class	Dimensions (inches)				
	A	B	C	D	E
Minimum	30	0.50	0.75	7E	1.88
Conventional	36	0.63	0.88	8E	2.25
Expwy/Fwy	48	0.75	1.25	10E	3.00

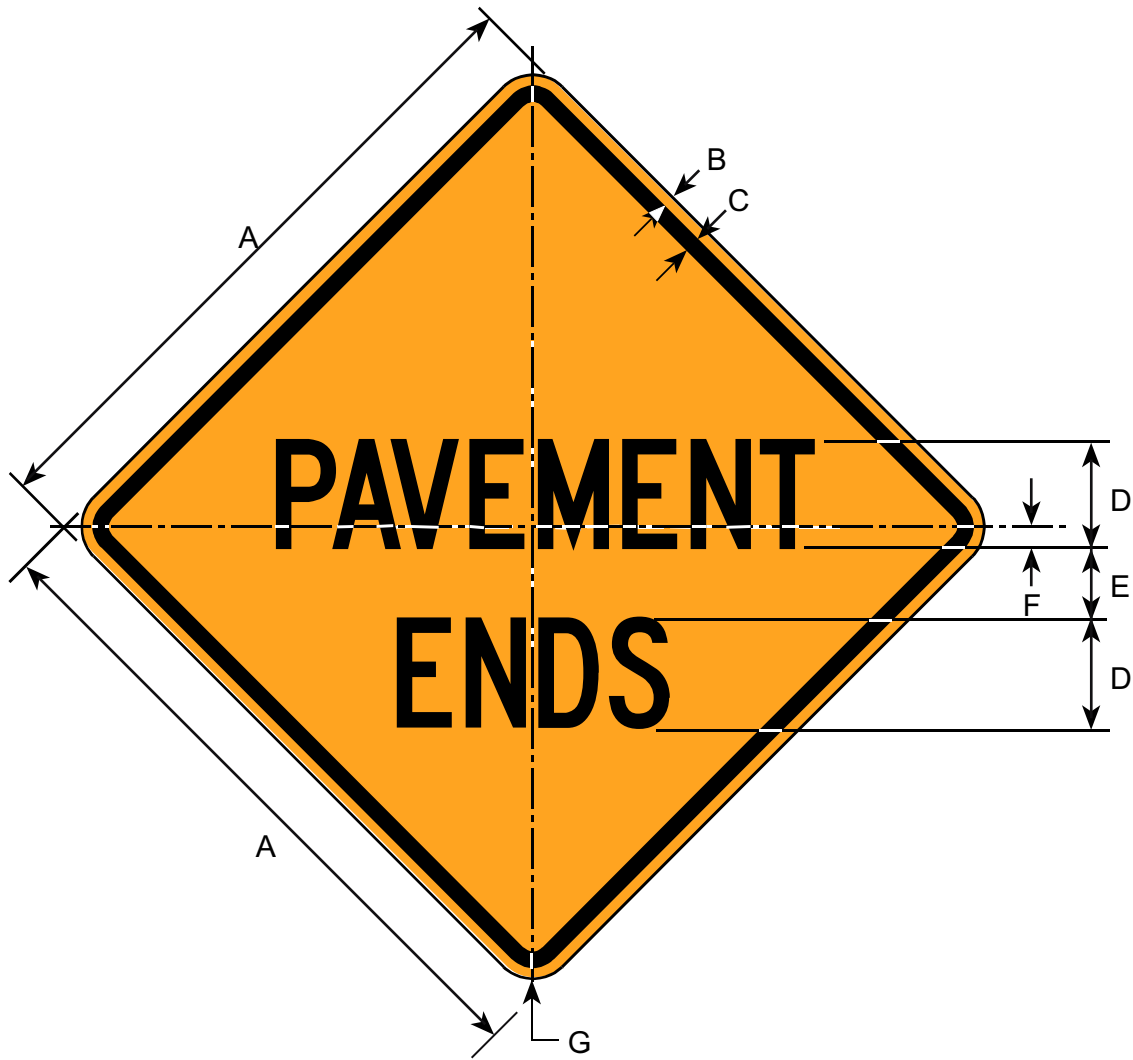

Border and Legend: Black
Background: Orange

Road Class	Dimensions (inches)						
	A	B	C	D	E	F	G
Minimum	30	0.50	0.75	5C	3.0	0.75	1.88
Conventional	36	0.63	0.88	6C	3.5	1.00	2.25
Expwy/Fwy	48	0.75	1.25	8C	4.5	1.50	3.00

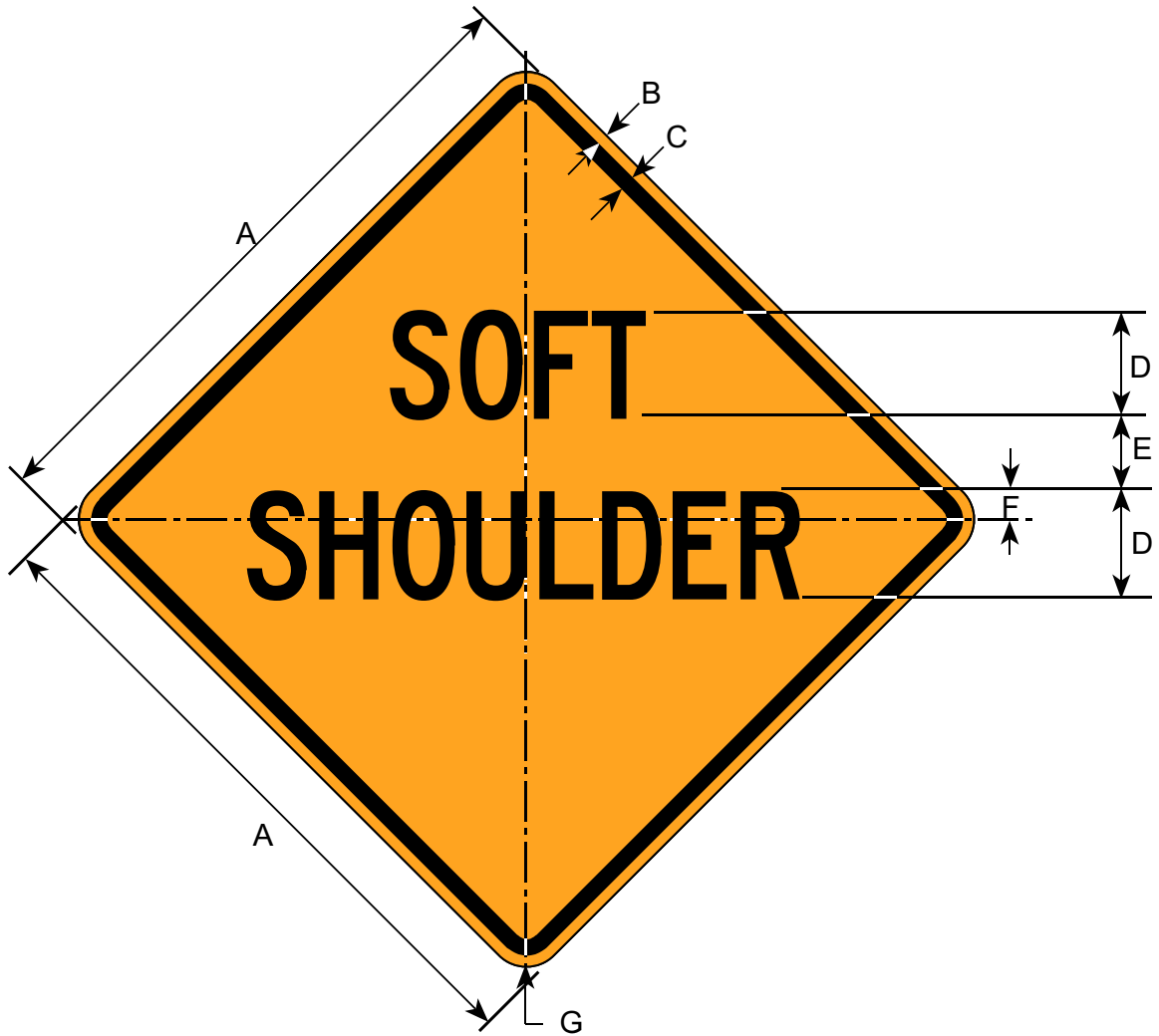

Border and Legend: Black
Background: Orange

Road Class	Dimensions (inches)						
	A	B	C	D	E	F	G
Minimum	30	0.50	0.75	5C	3.0	0.75	1.88
Conventional	36	0.63	0.88	6C	3.5	1.00	2.25
Expwy/Fwy	48	0.75	1.25	8C	5.0	1.25	3.00

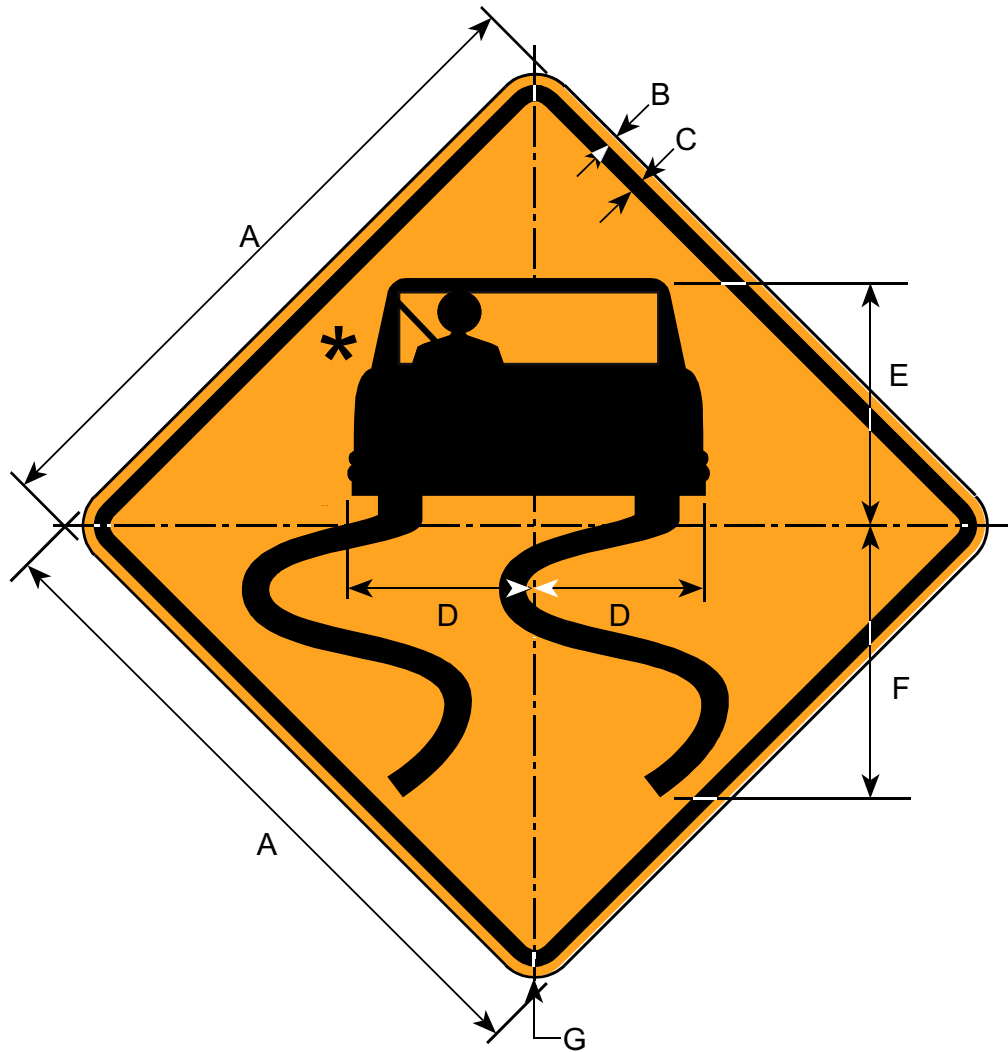

*Make symbol proportional to the graphic shown.

Border and Legend: Black
Background: Orange

Sign shall only be used with CW8-5P Slippery When Wet (Plate)

Road Class	Dimensions (inches)						
	A	B	C	D	E	F	G
Minimum	30	0.50	0.75	8	11	12.50	1.88
Conventional	36	0.63	0.88	9.50	13	14.81	2.25
Expwy/Fwy	48	0.75	1.25	12.63	17.33	19.75	3

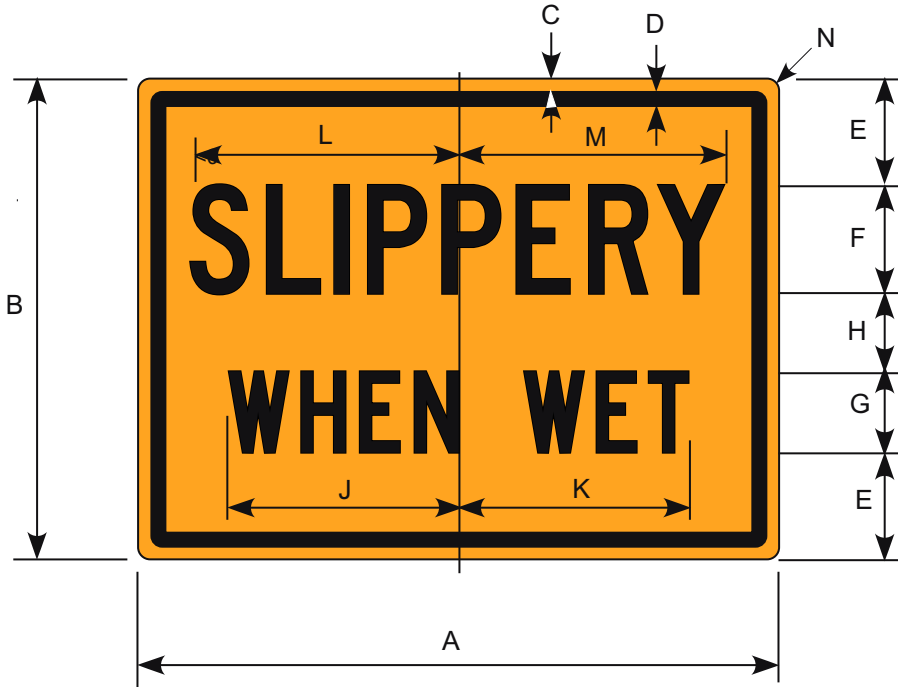

Border and Legend: Black
 Background: Orange

Plate shall only be used with CW8-5 Slippy When Wet

Road Class	Dimensions (inches)													
	A	B	C	D	E	F	G	H	J	K	L	M	N	
Conventional	24	18	0.38	0.63	4	4C	3C	3	8.69	8.63	9.88	10	1.5	

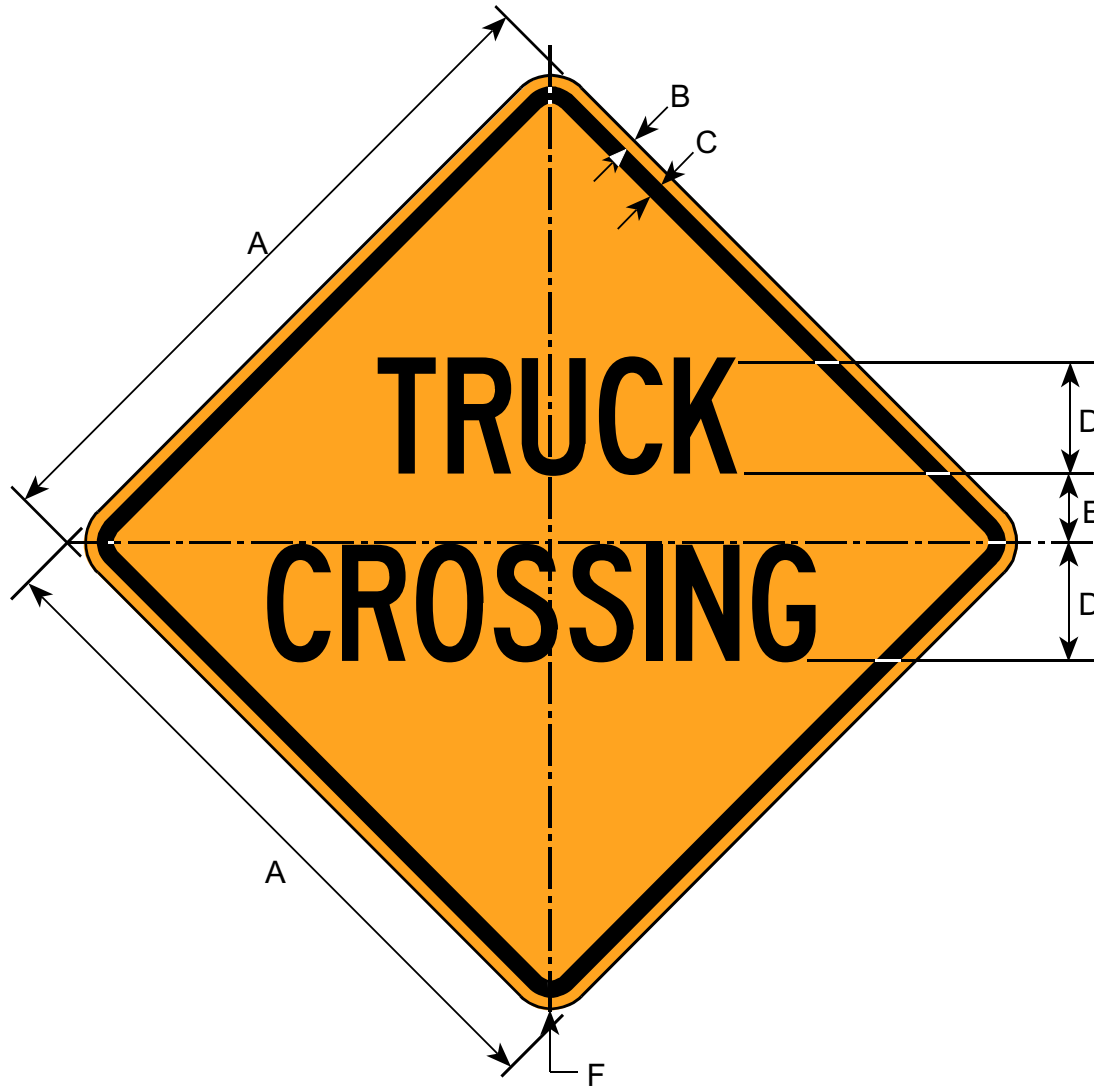

Border and Legend: Black
Background: Orange

Road Class	Dimensions (inches)					
	A	B	C	D	E	F
Minimum	30	0.50	0.75	5C	3.0	1.88
Conventional	36	0.63	0.88	6C	3.5	2.25
Expwy/Fwy	48	0.75	1.25	8C	5.0	3.00

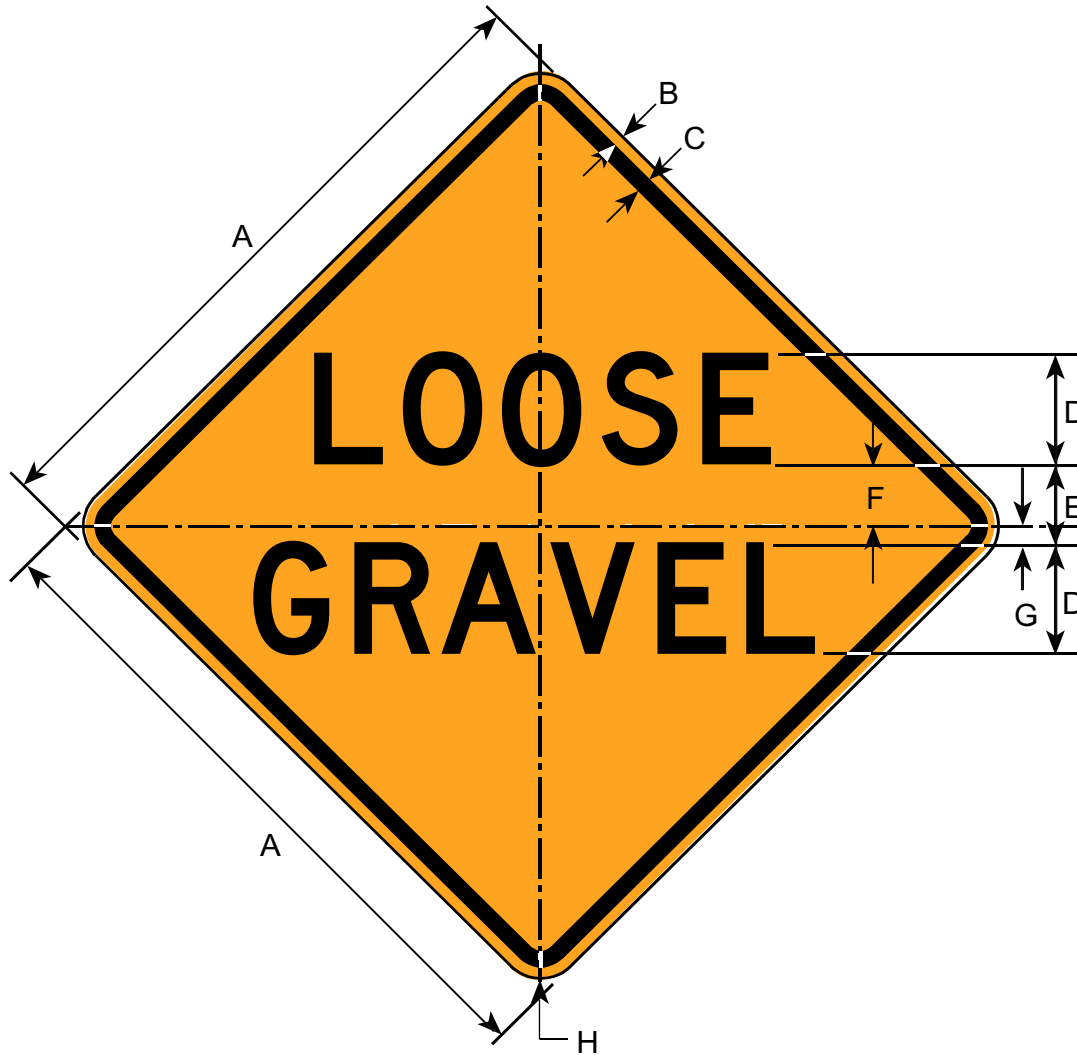

Border and Legend: Black
Background: Orange

Road Class	Dimensions (inches)							
	A	B	C	D	E	F	G	H
Minimum	30	0.50	0.75	5D	3.44	2.81	0.63	1.88
Conventional	36	0.63	0.88	6D	4.13	3.38	0.75	2.25
Expwy/Fwy	48	0.75	1.25	8D	5.50	4.50	1.00	3.00

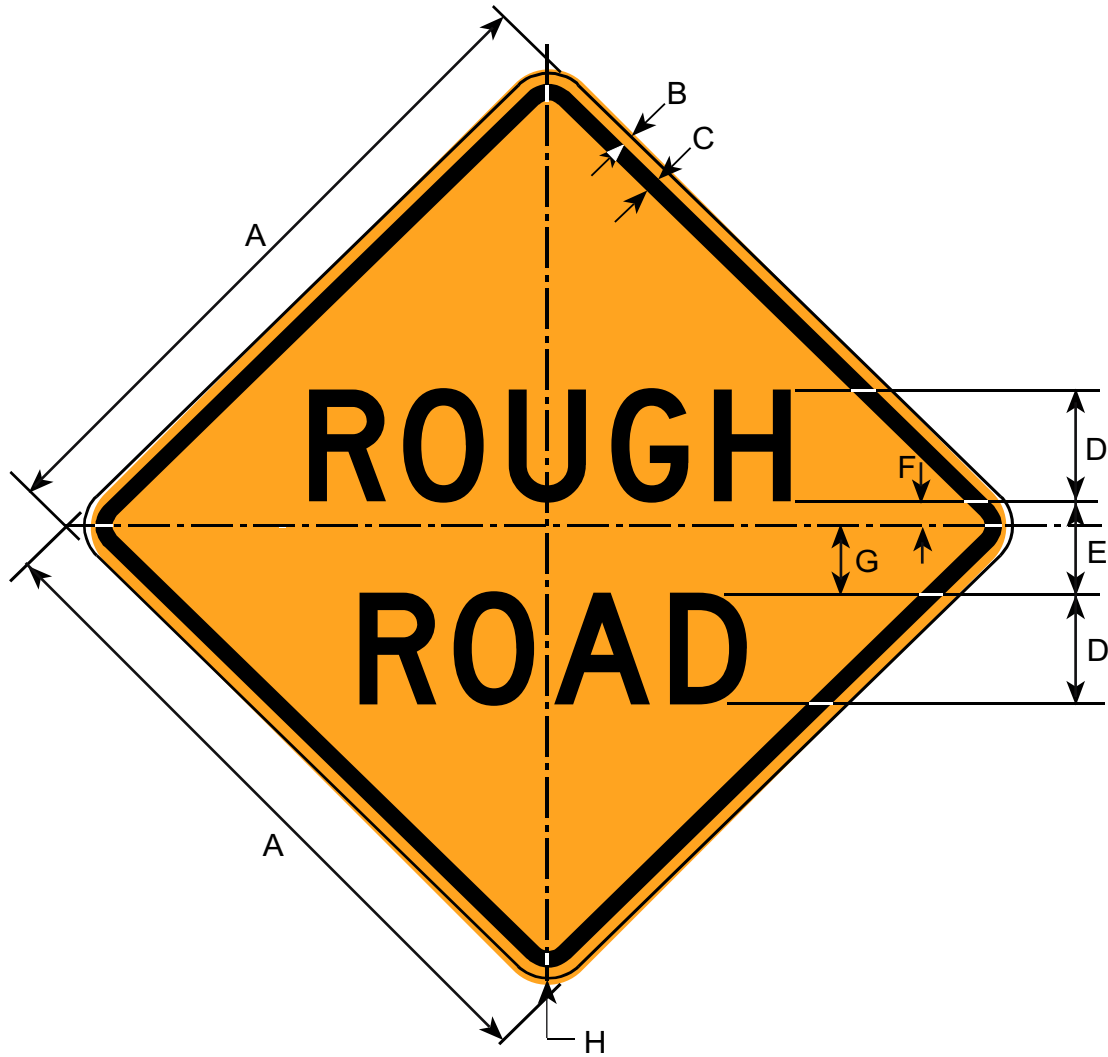

Border and Legend: Black
Background: Orange

Road Class	Dimensions (inches)							
	A	B	C	D	E	F	G	H
Minimum	30	0.50	0.75	5D	4	0.87	3.13	1.88
Conventional	36	0.63	0.88	6D	5	1.00	4.00	2.25
Expwy/Fwy	48	0.75	1.25	8D	6	1.50	4.50	3.00

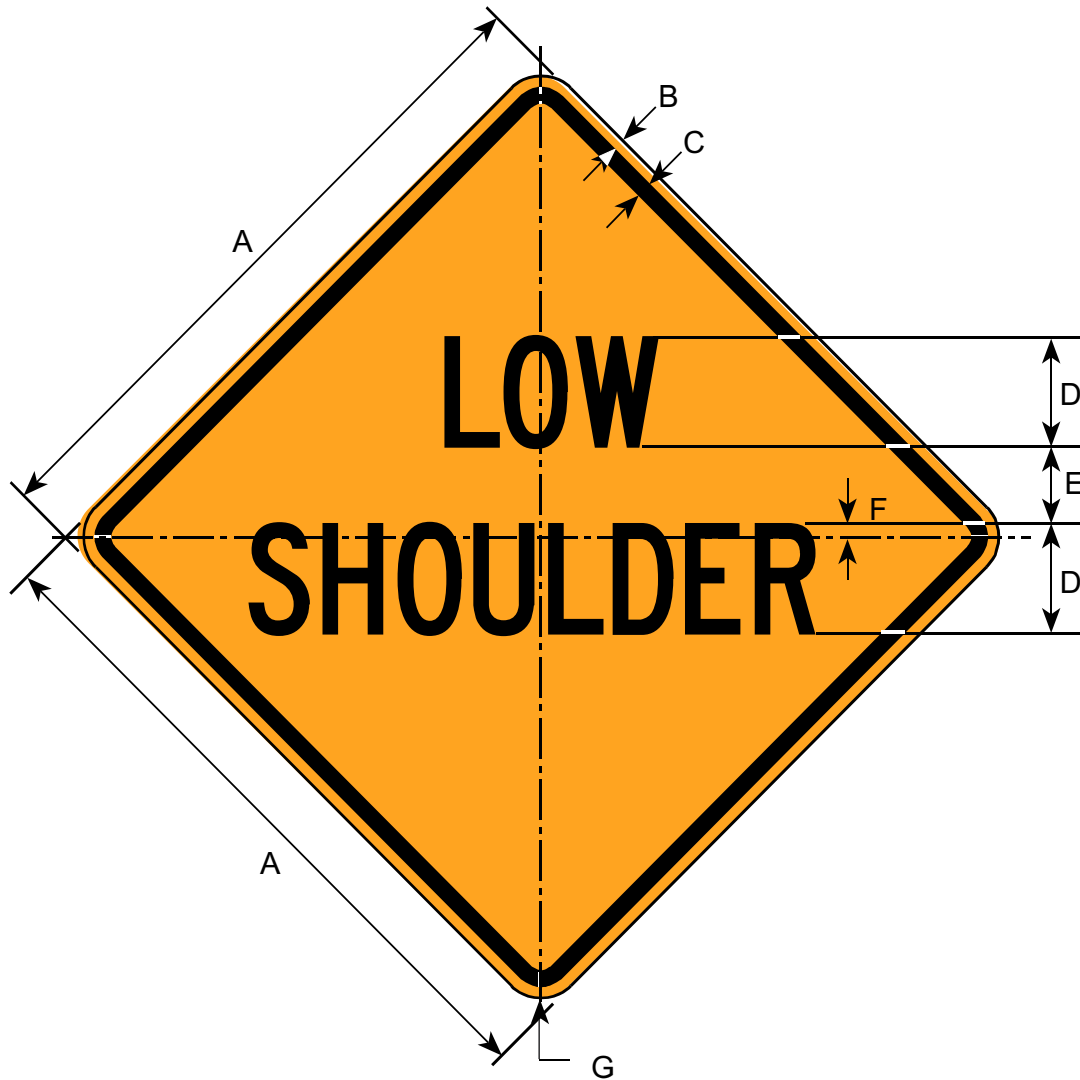

Border and Legend: Black
Background: Orange

Road Class	Dimensions (inches)						
	A	B	C	D	E	F	G
Minimum	30	0.50	0.75	5C	3.0	0.75	1.88
Conventional	36	0.63	0.88	6C	3.5	1.00	1.25
Expwy/Fwy	48	0.75	1.25	8C	5.0	1.25	3.00

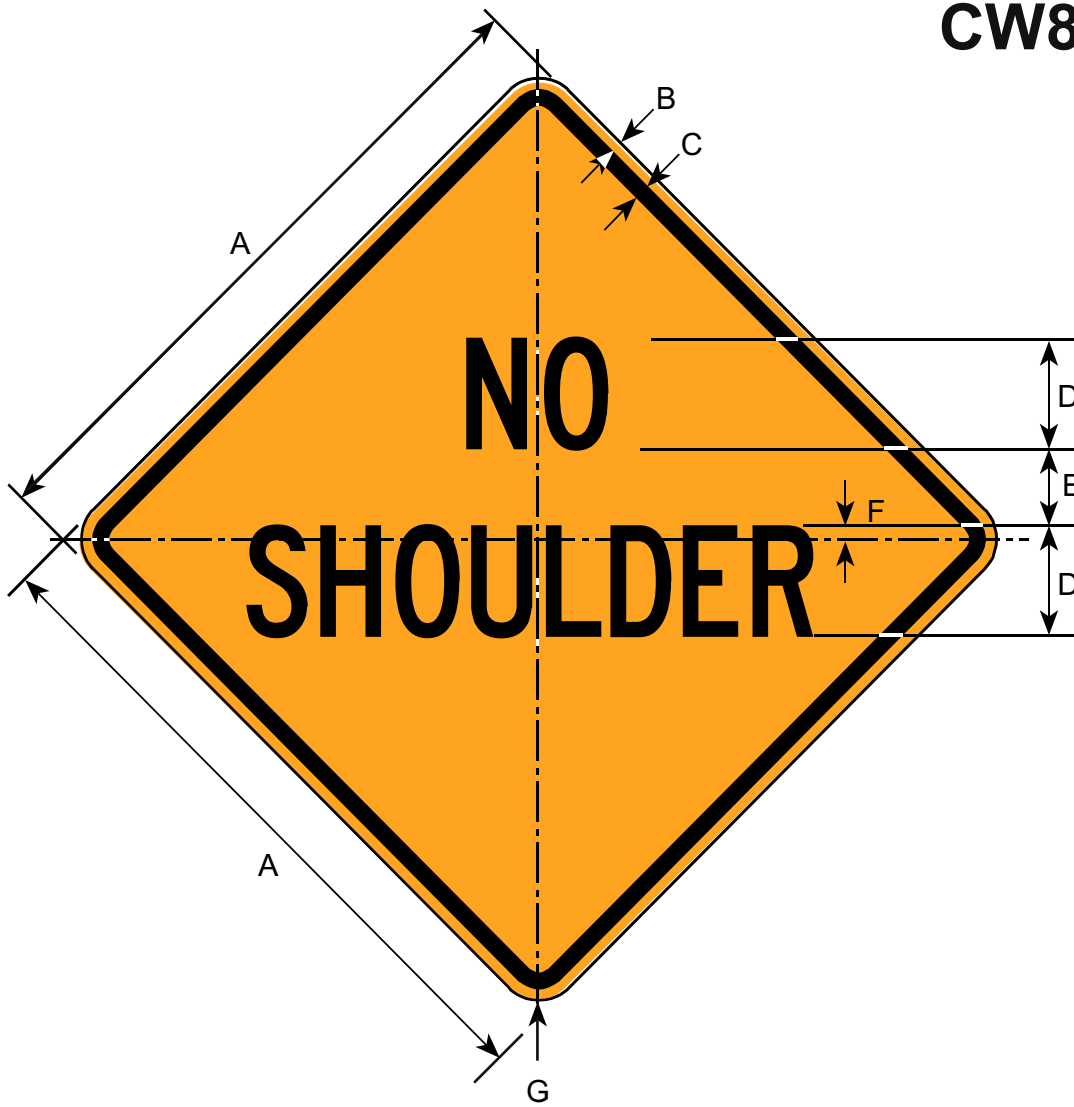

Border and Legend: Black
Background: Orange

Prior to the 2002 publication of this manual, this sign was numbered CW8-10.

Road Class	Dimensions (inches)						
	A	B	C	D	E	F	G
Minimum	30	0.50	0.75	5C	3.0	0.75	1.88
Conventional	36	0.63	0.88	6C	3.5	1.00	1.25
Expwy/Fwy	48	0.75	1.25	8C	5.0	1.25	3.00

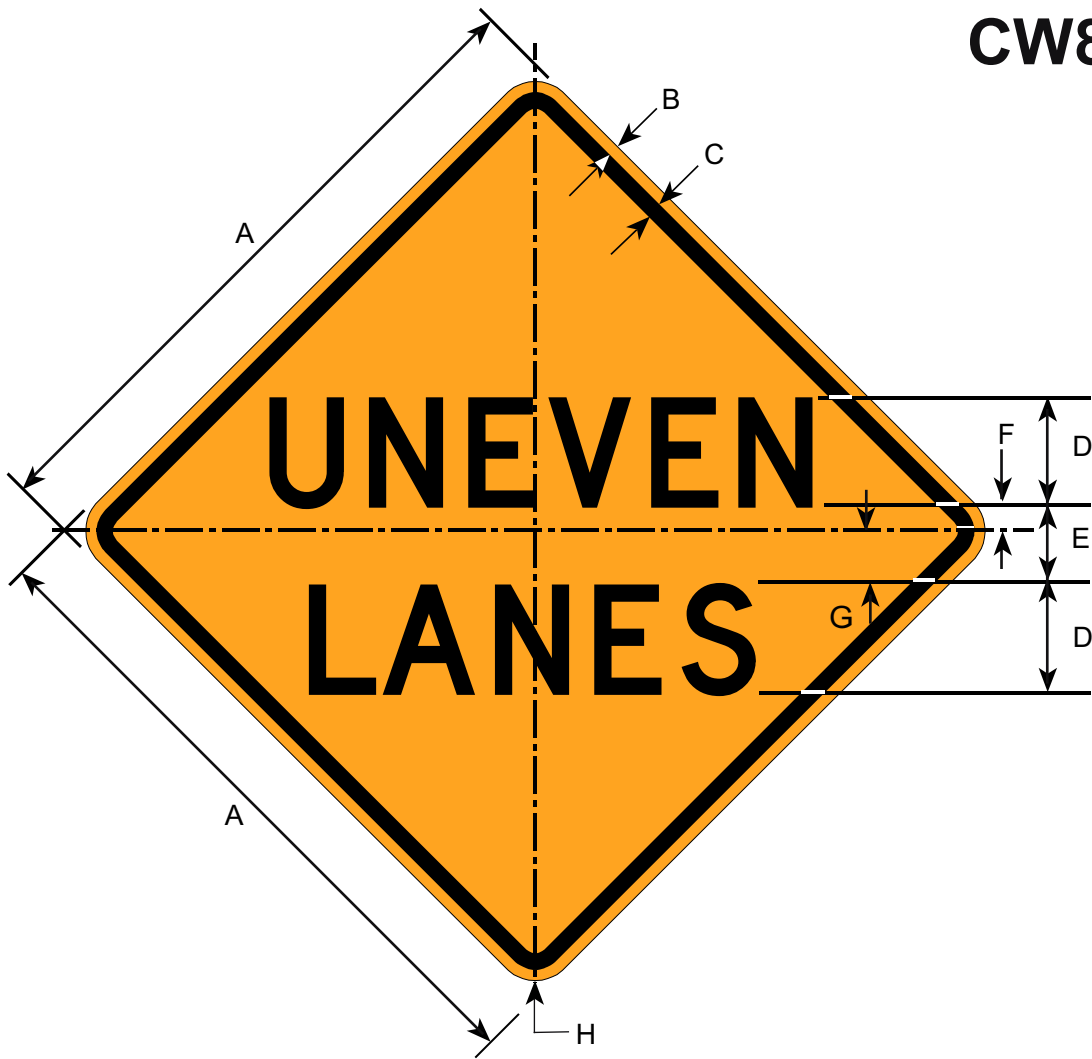

Border and Legend: Black
Background: Orange

Road Class	Dimensions (inches)							
	A	B	C	D	E	F	G	H
Conv & Min	36	0.63	0.88	6D	4.5	1.0	3.5	1.5
Expwy/Fwy	48	0.75	1.25	7D	6.0	1.5	4.5	2.0

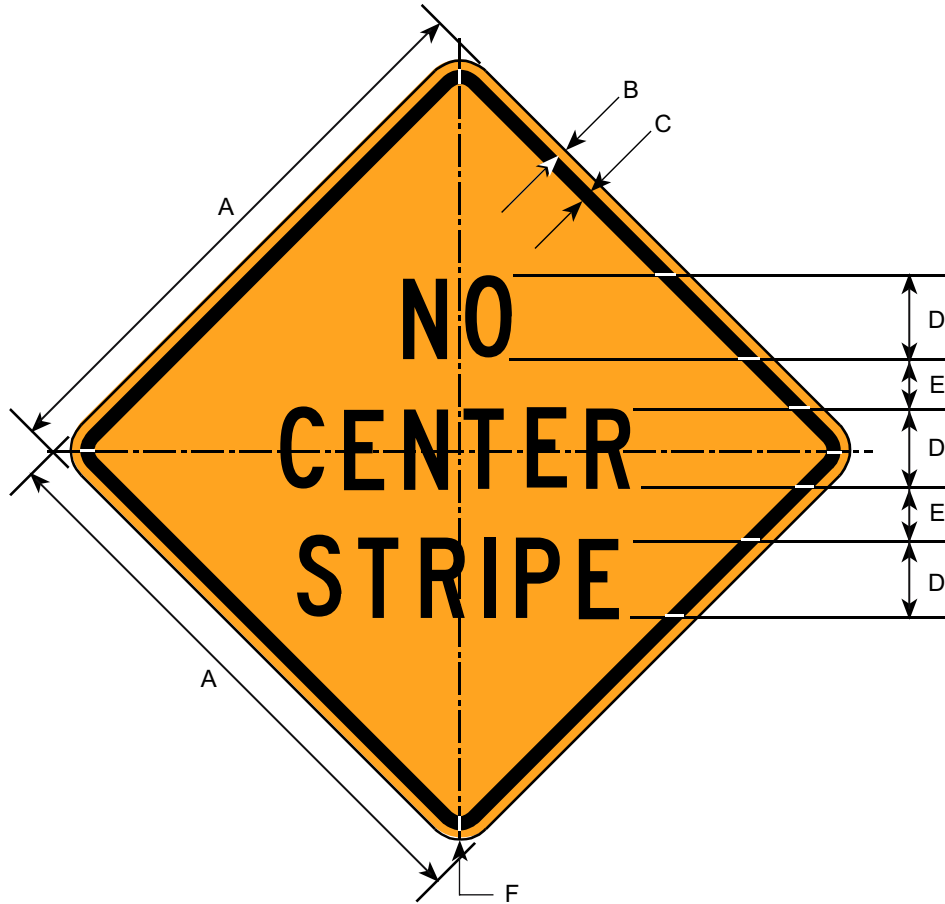

Border and Legend: Black
Background: Orange

Road Class	Dimensions (inches)					
	A	B	C	D	E	F
Minimum	30	0.50	0.75	4C	2.50	1.88
Conventional	36	0.63	0.88	5C	3.25	2.25
Expwy/Fwy	48	0.75	1.25	7C	4.50	3.00

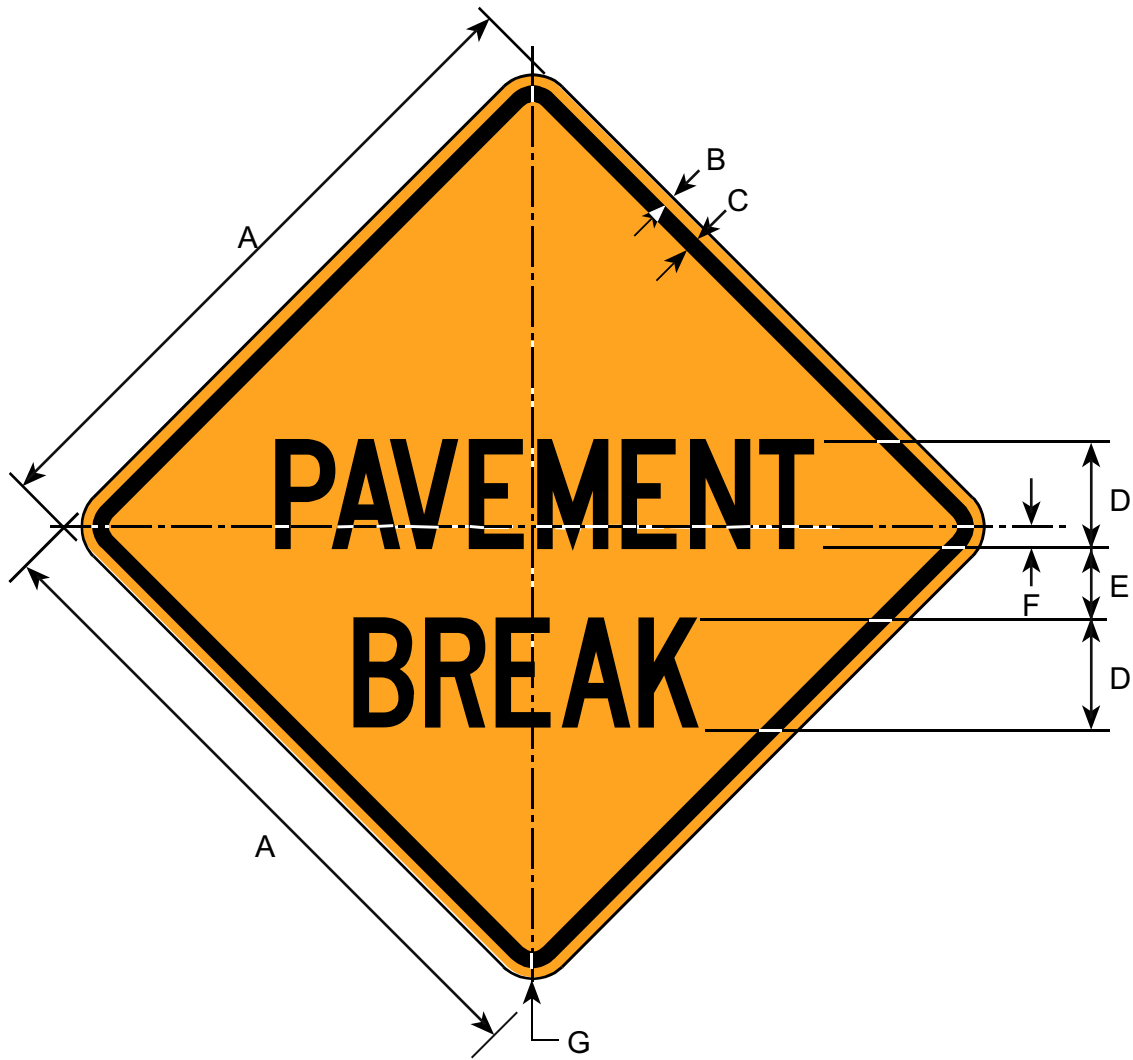

Border and Legend: Black
Background: Orange

Road Class	Dimensions (inches)						
	A	B	C	D	E	F	G
Minimum	30	0.50	0.75	5C	3.0	0.75	1.88
Conventional	36	0.63	0.88	6C	3.5	1.00	2.25
Expwy/Fwy	48	0.75	1.25	8C	4.5	1.50	3.00

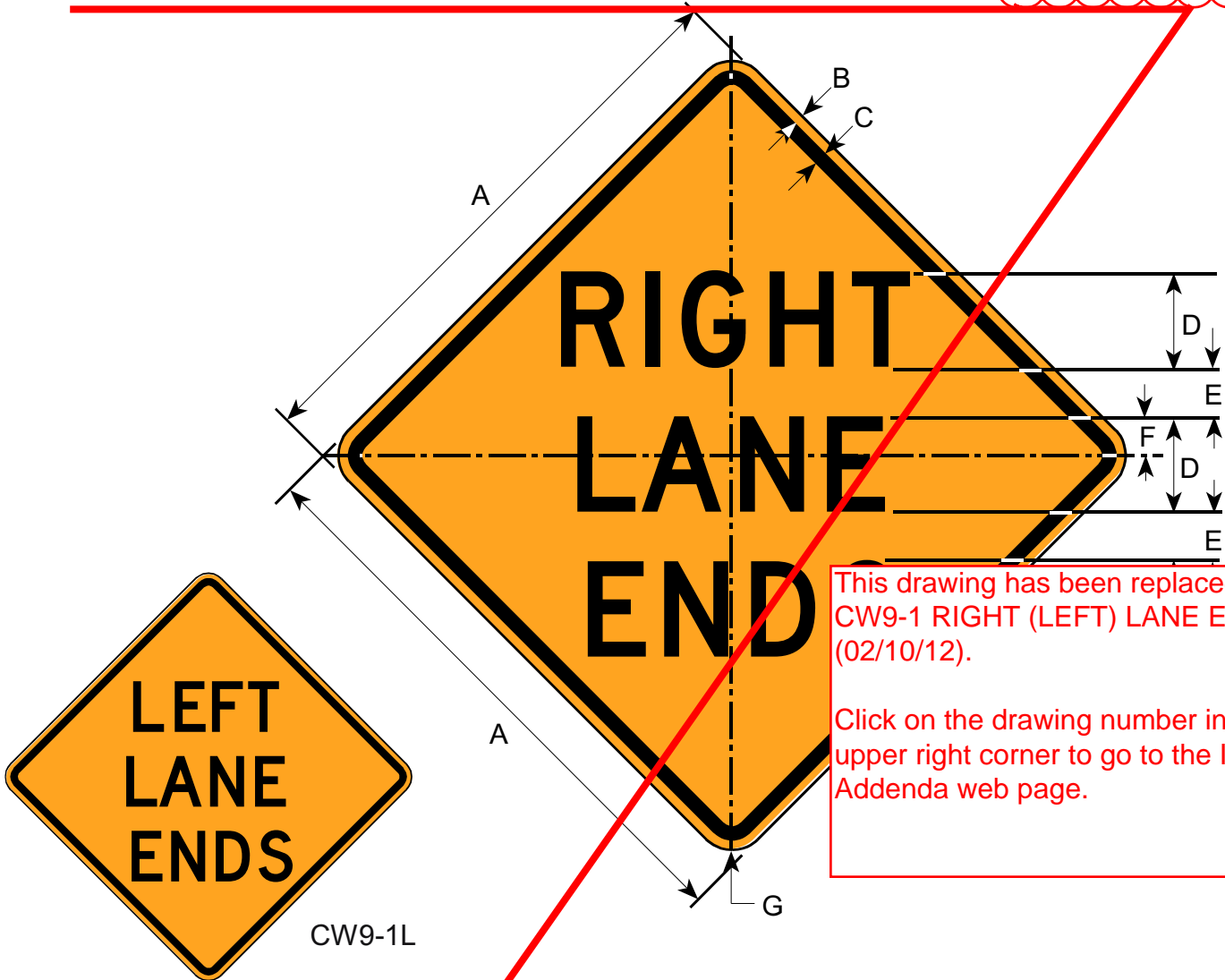

This drawing has been replaced with:
CW9-1 RIGHT (LEFT) LANE ENDS
 (02/10/12).

Click on the drawing number in the
 upper right corner to go to the Interim
 Addenda web page.

Border and Legend: Black
 Background: Orange

Road Class	Dimensions (inches)						
	A	B	C	D	E	F	G
Minimum	36	0.63	0.88	6D	3.0	2.0	2.25
Conventional	48	0.75	1.25	8D	4.0	3.0	3.0
Exp/Fwy	60	1.0	1.5	10D	5.0	0.5	3.75

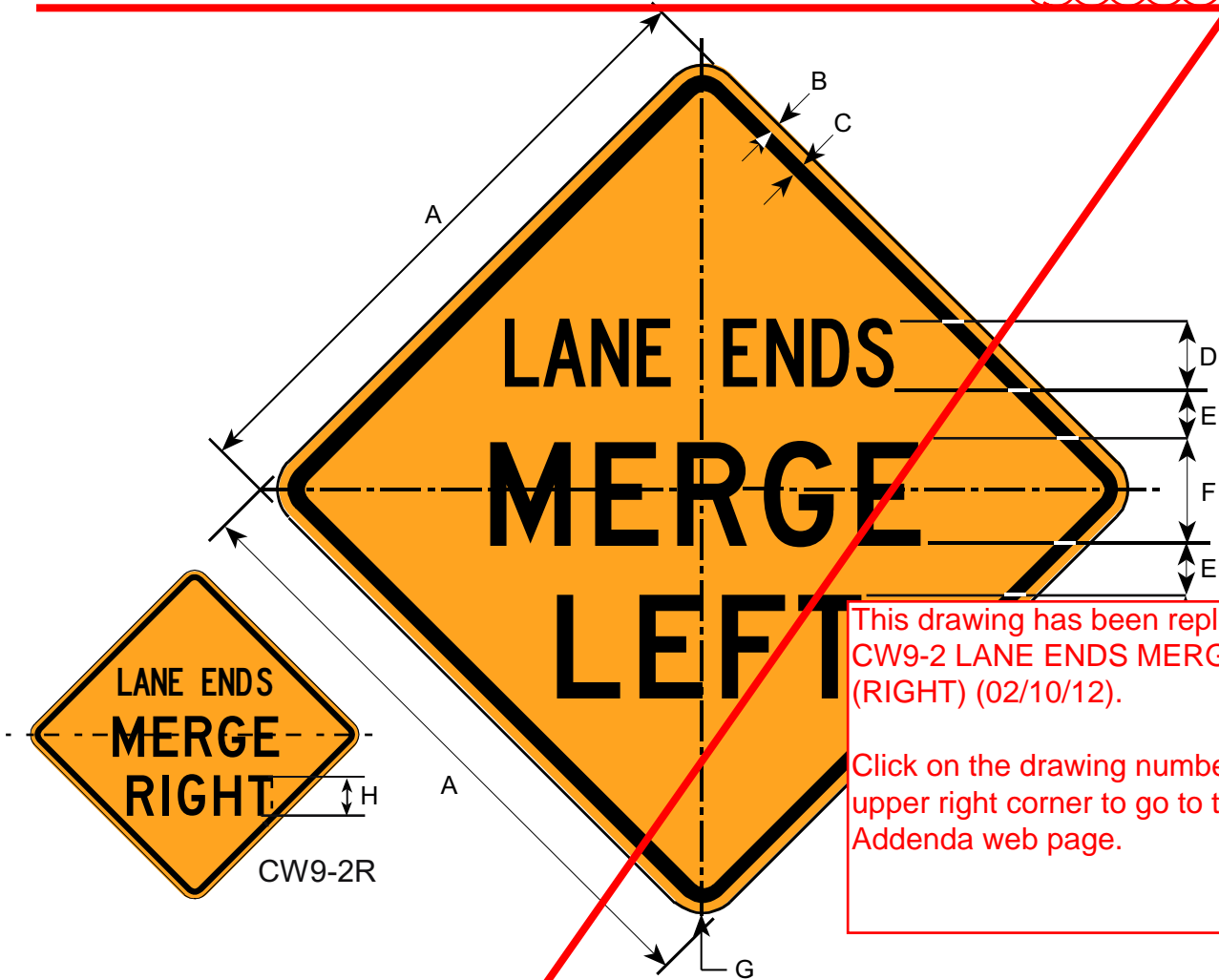

Border and Legend: Black
Background: Orange

Road Class	Dimensions (inches)							
	A	B	C	D	E	F	G	H
Minimum	36	0.63	0.88	4D	3.0	6D	2.25	6D
Conventional	48	0.75	1.25	6D	4.0	8D	3.0	8D
Expwy/Fwy	60	1.0	1.5	7D	5.0	10D	3.75	10D

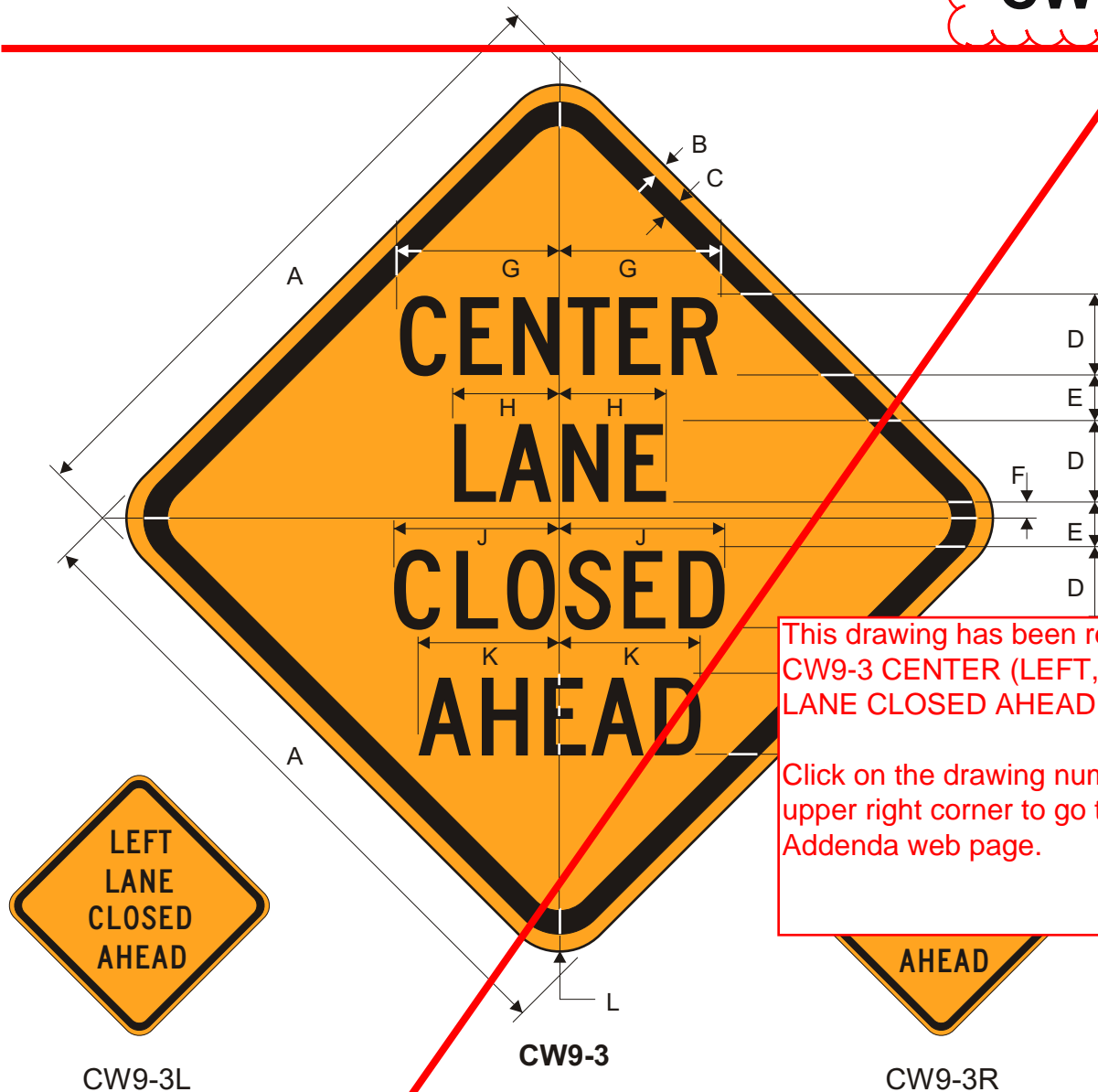

This drawing has been replaced with:
 CW9-3 CENTER (LEFT, RIGHT)
 LANE CLOSED AHEAD (02/10/12).

Click on the drawing number in the
 upper right corner to go to the Interim
 Addenda web page.

Border and Legend: Black
 Background: Orange

Road Class	Dimensions (inches)										
	A	B	C	D	E	F	G	H	J	K	L
Minimum	30	0.5	0.75	4C	2.24	0.88	8.0	5.3	8.17	6.99	1.88
Conventional	36	0.63	0.88	5C	2.0	0.68	10	6.6	10.21	8.73	2.25
Expy/Fwy	48	0.75	1.25	6C	4.52	1.08	12.05	7.89	12.25	10.47	3.0
Oversized	60	0.75	1.25	8C	5.2	1.64	16.05	10.51	16.33	13.95	3.0



Border and Legend: Black
Background: Orange

Road Class	Dimensions (inches)										
	A	B	C	D	E	F	G	H	J	K	L
Conventional	72	48	0.75	1.25	6	5D	5	4	8D	5C	3



Border and Legend: Black
Background: Orange

Road Class	Dimensions (inches)										
	A	B	C	D	E	F	G	H	J	K	L
Conventional	66	48	0.75	1.25	6	5D	5	4	8D	5C	3

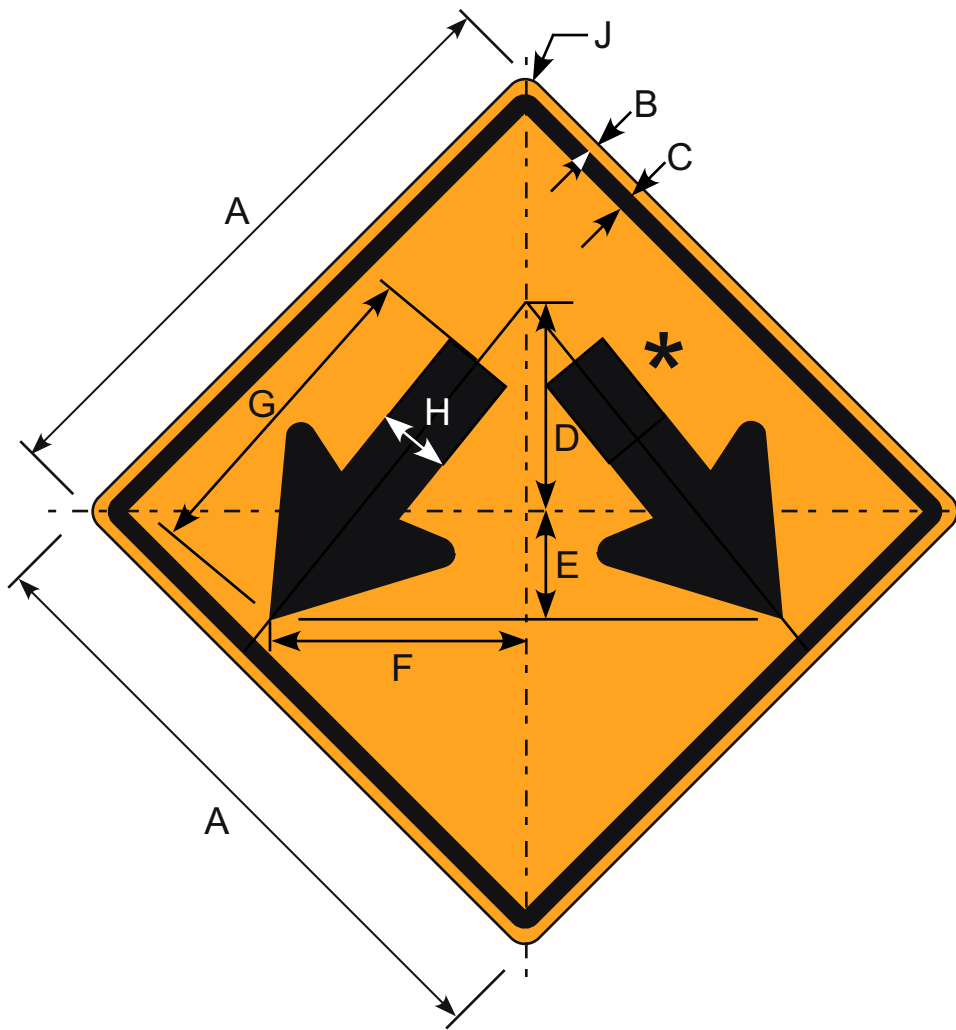

Border and Legend: Black
Background: Orange

* See Appendix B-1 for
Standard Arrow Detail

Road Class	Dimensions (inches)								
	A	B	C	D	E	F	G	H	J
Minimum	30	0.50	0.75	10	5.25	12.38	14.69	4.0	1.88
Conventional	36	0.63	0.88	12	6.13	14.63	17.5	4.75	2.25
Expwy/Fwy	48	0.75	1.25	16	8.4	19.8	25.5	5.5	3.0

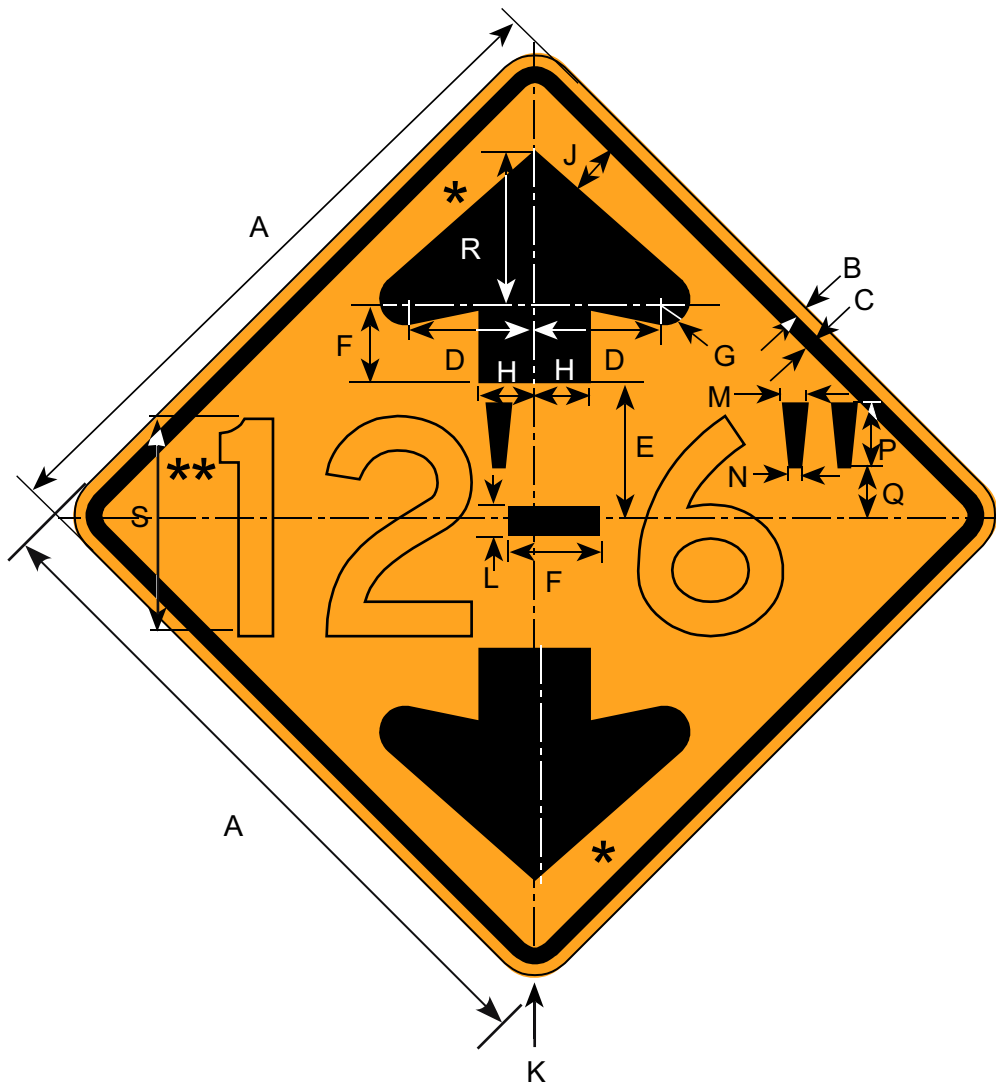

Border and Legend: Black
Background: Orange

**If clearance height does not fit reduce letter series or height as necessary.

* See Appendix B-1 for Standard Arrow Details.

Road Class	Dimensions (inches)										
	A	B	C	D	E	F	G	H	J	K	L
Minimum	30	0.50	0.75	5.75	6.63	3.75	0.75	2.5	1.69	1.88	1.56
Conventional	36	0.63	0.88	6.88	8.0	4.5	1.0	3.0	2.0	2.25	1.88
Expwy/Fwy	48	0.75	1.25	9.19	10.63	5.88	1.31	4.0	2.63	3.0	2.44

M	N	P	Q	S
1.0	0.44	2.25	3.31	10D
1.25	0.50	2.75	4.0	12D
1.63	0.63	3.63	5.5	16D

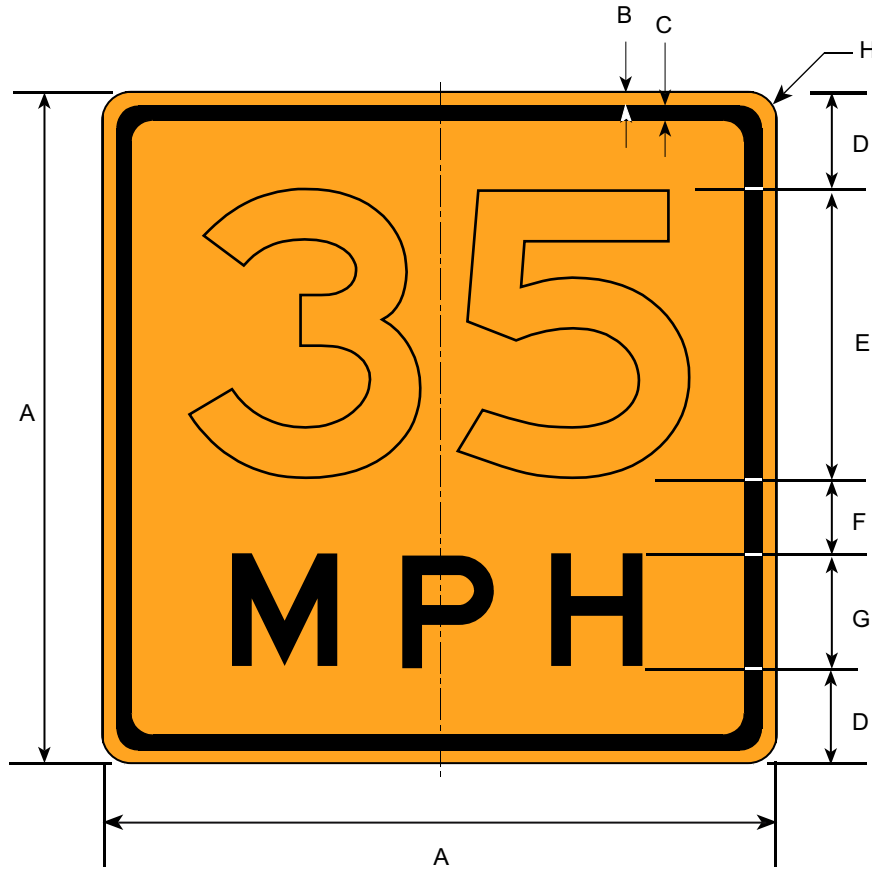
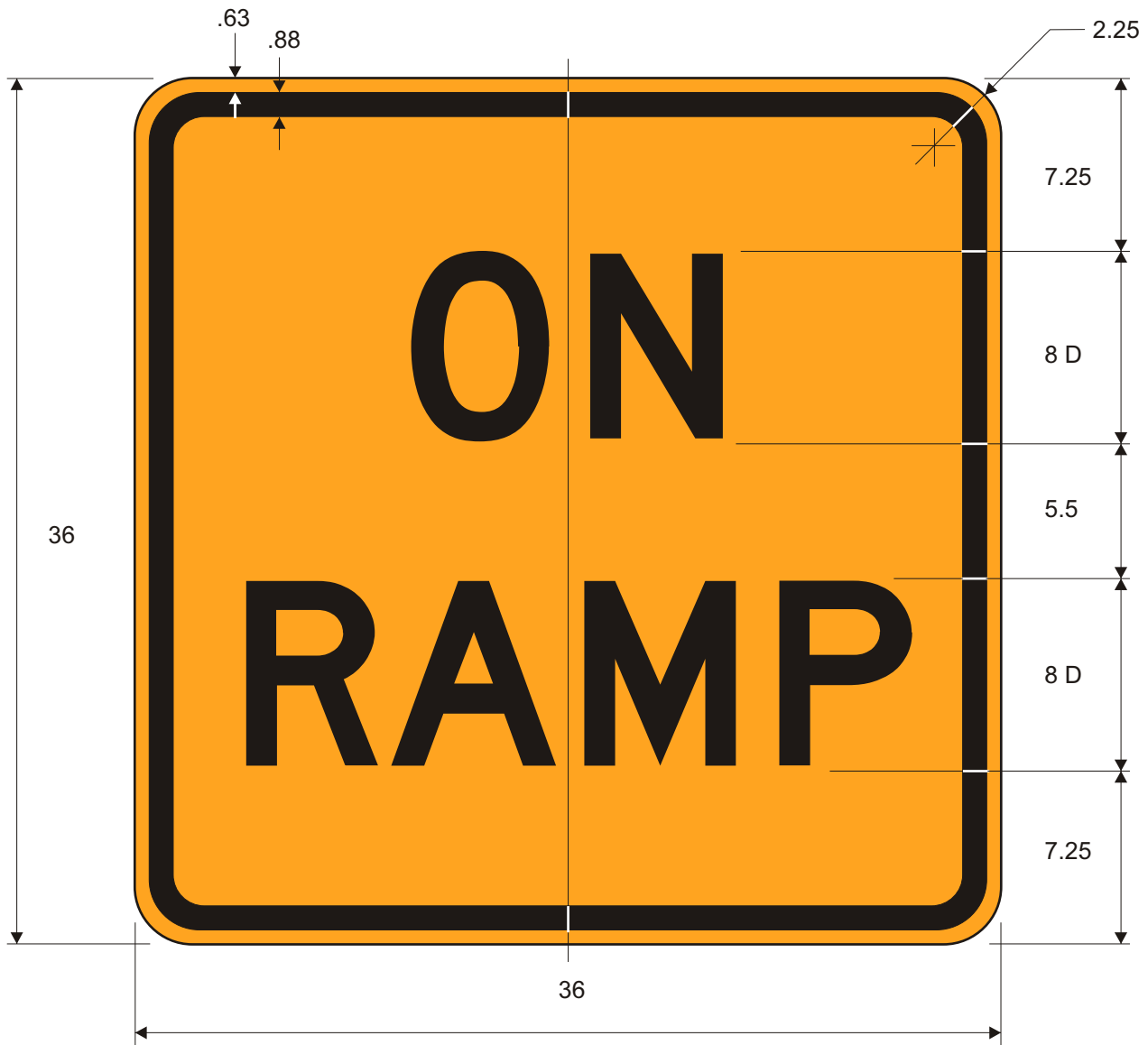

Plate shall not be used alone.

Border and Legend: Black
Background: Orange

Road Class	Dimensions (inches)							
	A	B	C	D	E	F	G	H
Minimum	18	0.38	0.63	2.5	8E	2.00	3E	1.5
Conventional	24	0.38	0.63	3.5	10E	2.75	4E	1.5
Expwy/Fwy	36	0.75	0.88	4.5	15E	3.50	6E	2.5



Border and Legend: Black
Background: Orange

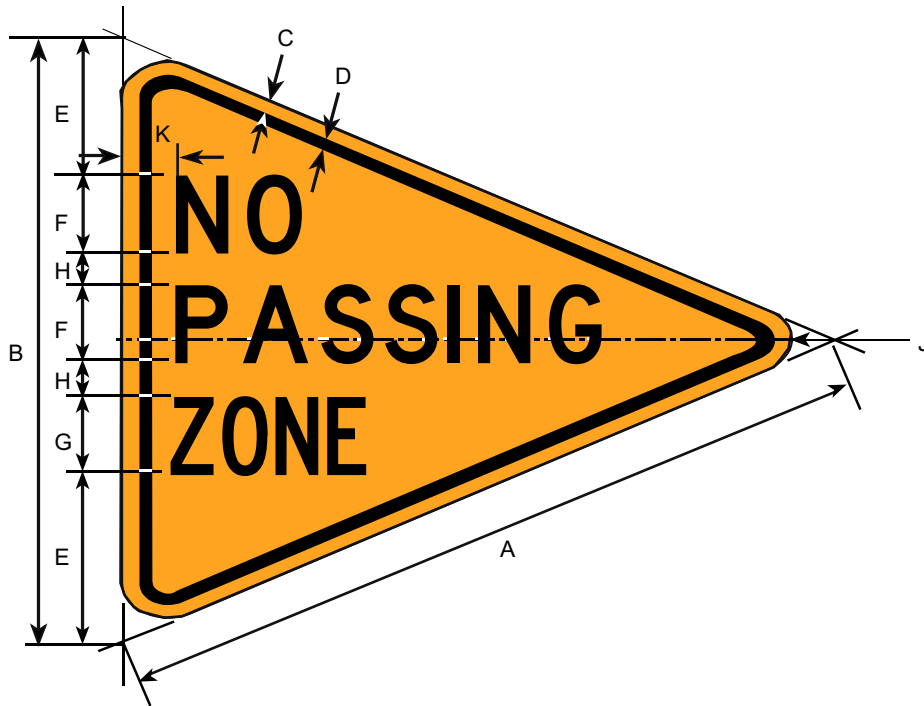

Border and Legend: Black
 Background: Orange

Road Class	Dimensions (inches)									
	A	B	C	D	E	F	G	H	J	K
Minimum	40	30	0.50	0.75	7.25	4D	4C	1.75	1.88	2.5
Conventional	48	36	0.63	0.88	8.5	5D	5C	2.0	2.25	3.0
Oversized	64	48	0.75	1.25	12	6D	6C	3.0	3.0	4.0

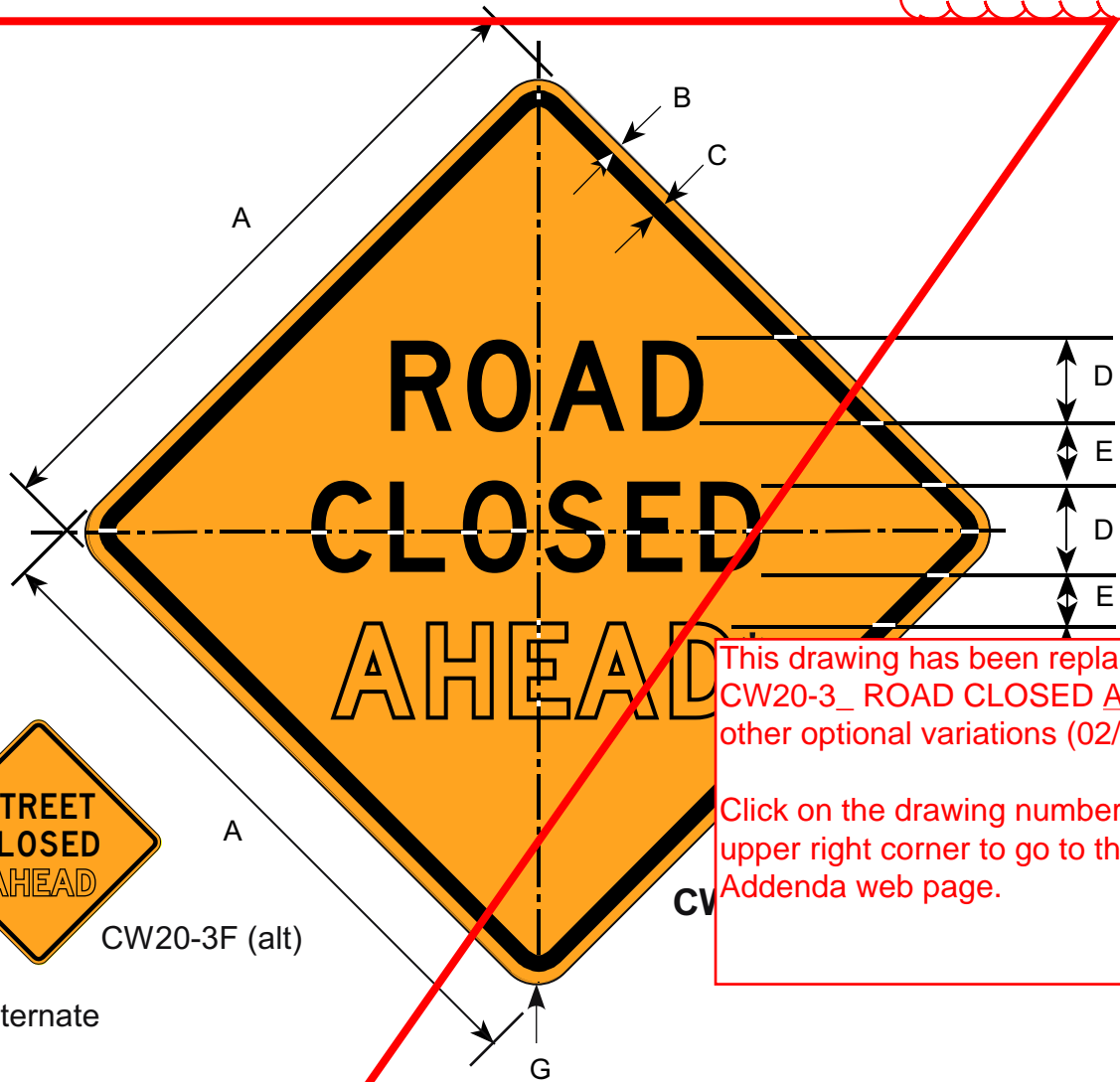

This drawing has been replaced with: CW20-3_ ROAD CLOSED AHEAD or other optional variations (02/10/12).
 Click on the drawing number in the upper right corner to go to the Interim Addenda web page.

Border and Legend: Black
 Background: Orange

Code Variable Legend
 A 500 FT
 B 1000 FT
 C 1 MILE
 D 1/2 MILE
 E 1500 FT
 F AHEAD
 Example: CW20-3F refers to "ROAD CLOSED AHEAD"

Road Class	Dimensions (inches)						
	A	B	C	D	E	F	G
Minimum	36	0.63	0.88	5D	3.75	2.5	2.25
Conventional	48	0.75	1.25	7D	5.25	3.5	3.0
Expwy/Fwy	60	0.75	1.25	9D	6.25	4.5	4.0

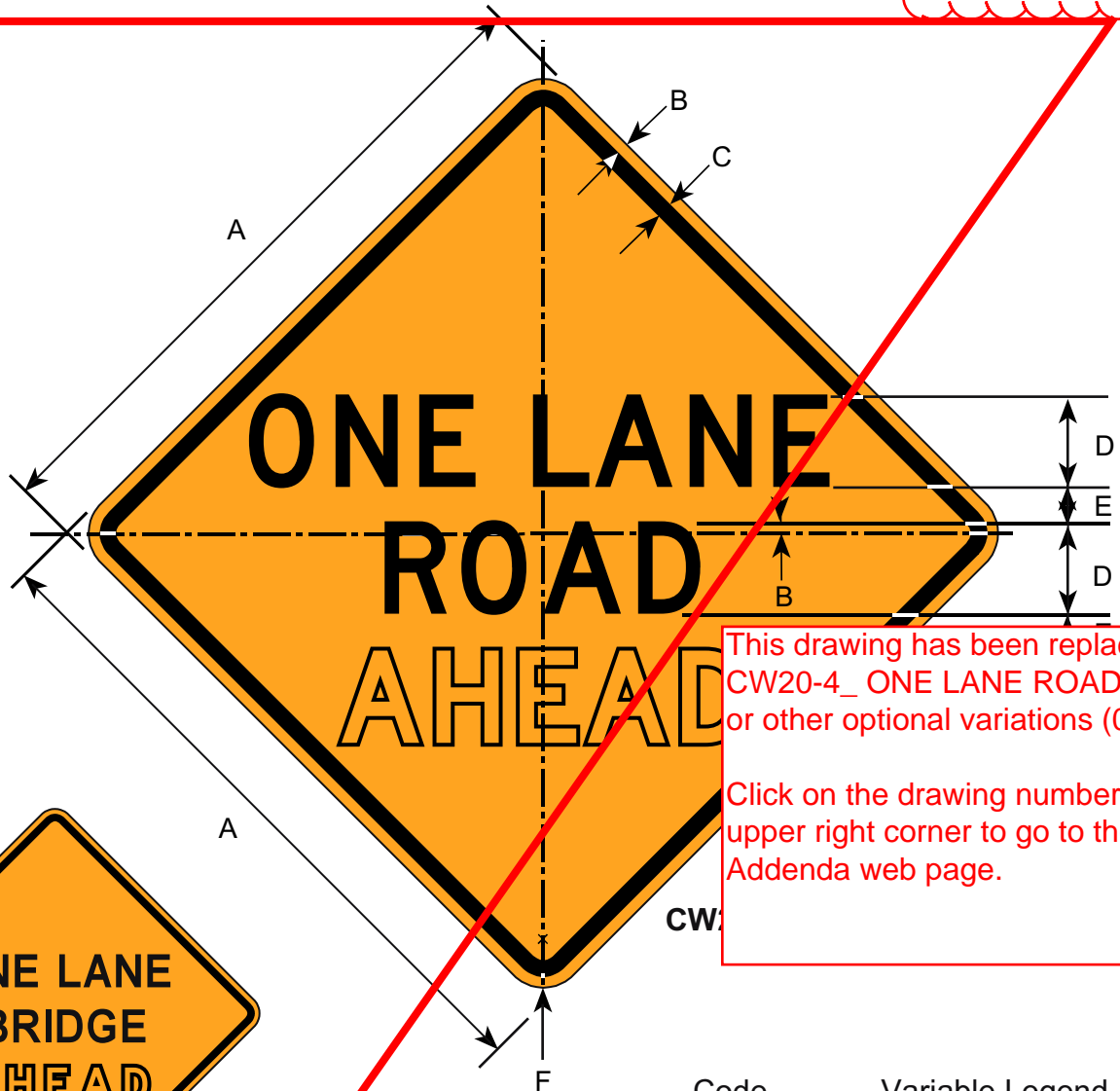

This drawing has been replaced with:
[CW20-4_ ONE LANE ROAD AHEAD](#)
 or other optional variations (02/10/12).
 Click on the drawing number in the
 upper right corner to go to the Interim
 Addenda web page.



CW20-4F (alt)

Alternate

- Code Variable Legend
- A 500 FT
 - B 1000 FT
 - C 1 MILE
 - D 1/2 MILE
 - E 1500 FT
 - F AHEAD
- Example: CW20-4F refers to "ONE LANE ROAD AHEAD"

Border and Legend: Black
 Background: Orange

Road Class	Dimensions (inches)					
	A	B	C	D	E	F
Minimum	36	0.63	0.88	5C	2.25	2.25
Conventional	48	0.75	1.25	7C	3.13	3.0
Expwy/Fwy	60	1.0	1.5	9C	4.5	3.75

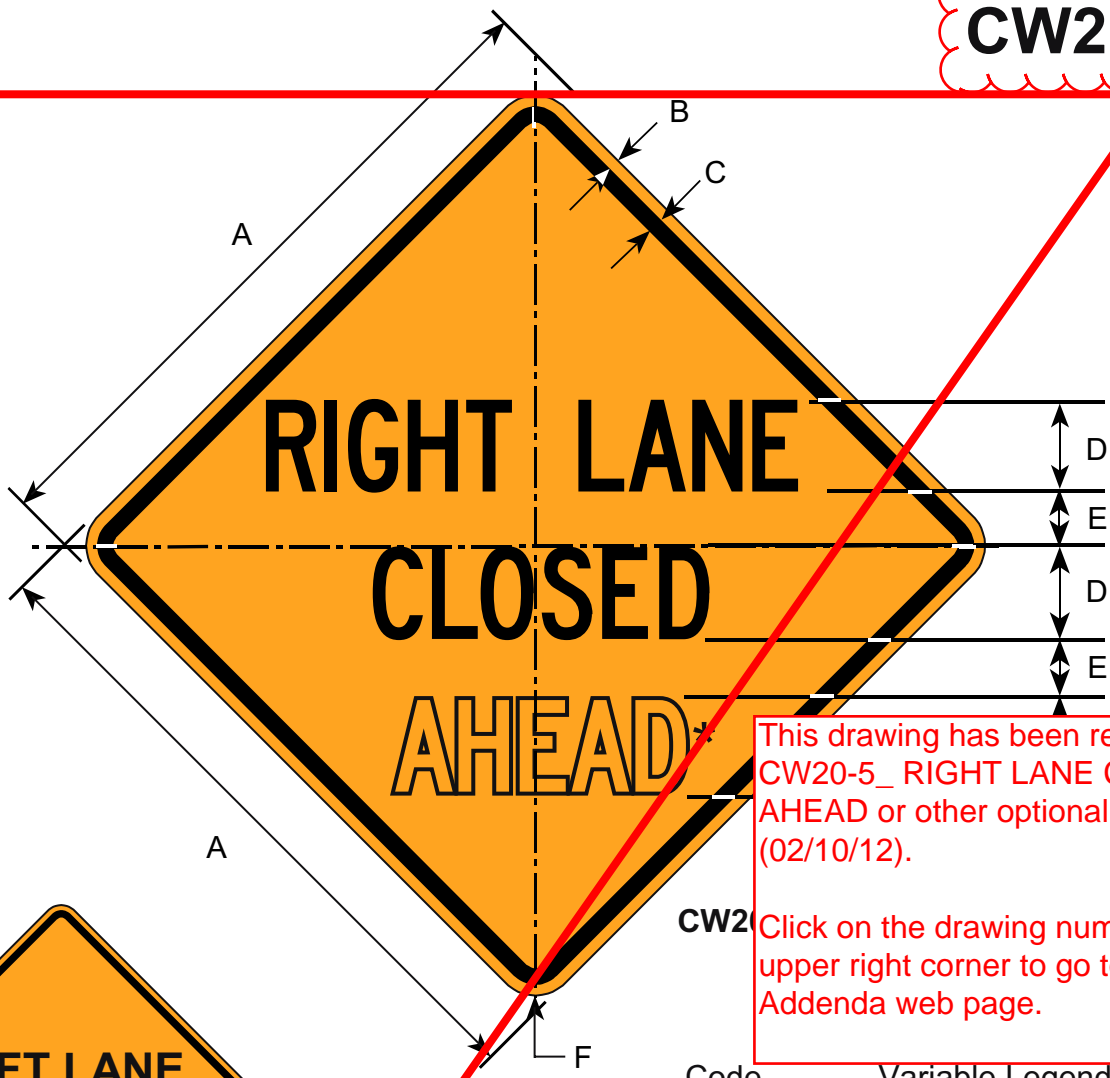

CW20-5F (alt)

Alternate

This drawing has been replaced with: CW20-5_ RIGHT LANE CLOSED AHEAD or other optional variations (02/10/12).
 Click on the drawing number in the upper right corner to go to the Interim Addenda web page.

Code	Variable Legend
A	500 FT
B	1000 FT
C	1 MILE
D	1/2 MILE
E	1500 FT
F	AHEAD

Example: CW20-5F refers to "RIGHT LANE ROAD AHEAD"

Border and Legend: Black
 Background: Orange

Road Class	Dimensions (inches)					
	A	B	C	D	E	F
Minimum	36	0.63	0.88	5C	2.75	2.25
Conventional	48	0.75	1.25	6C	3.38	3.0
Expwy/Fwy	60	1.0	1.5	8C	5.2	3.75

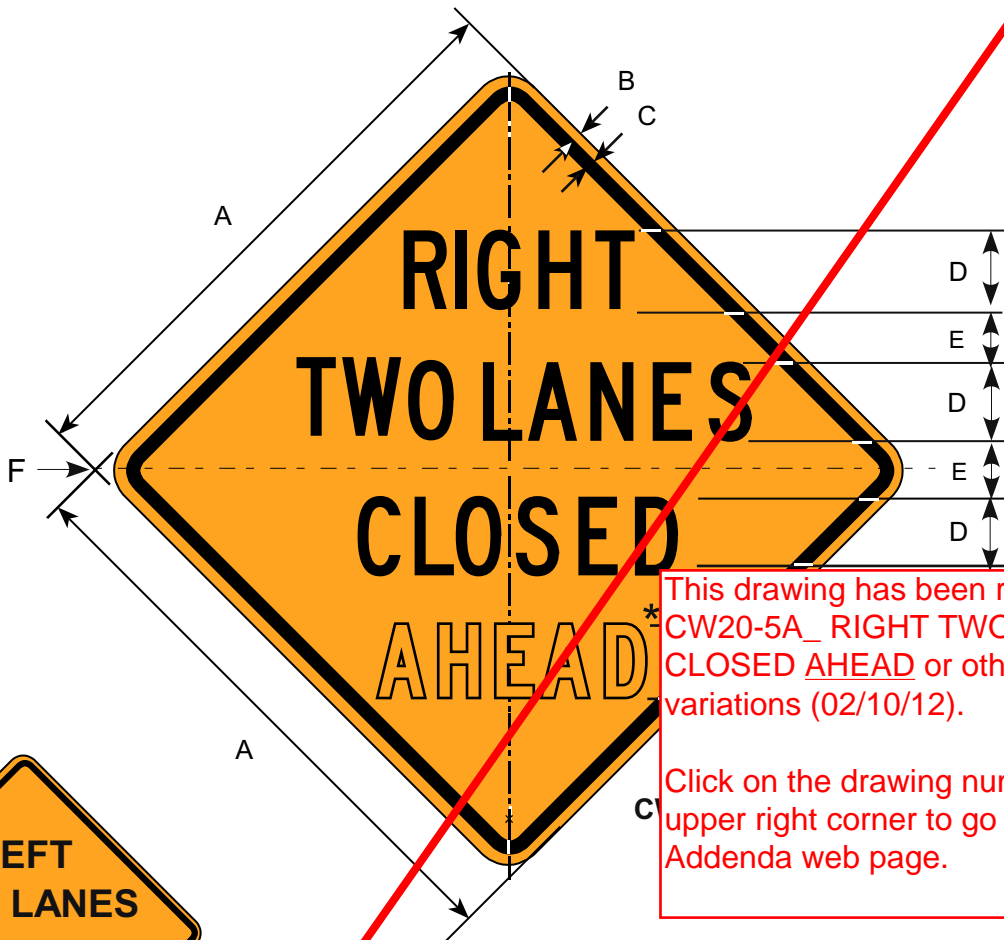

This drawing has been replaced with: CW20-5A_ RIGHT TWO LANES CLOSED AHEAD or other optional variations (02/10/12).

Click on the drawing number in the upper right corner to go to the Interim Addenda web page.



Code	Variable Legend
A	500 FT
B	1000 FT
C	1 MILE
D	1/2 MILE
E	1500 FT
F	AHEAD

Example: CW20-5AF refers to "RIGHT TWO LANES CLOSED AHEAD".

Border and Legend: Black
Background: Orange

Road Class	Dimensions (inches)					
	A	B	C	D	E	F
Minimum	36	0.63	0.88	5C	2.8	2.25
Conventional	48	0.75	1.25	6C	3.0	3.0
Expwy/Fwy	60	1.0	1.5	7C	4.0	3.75

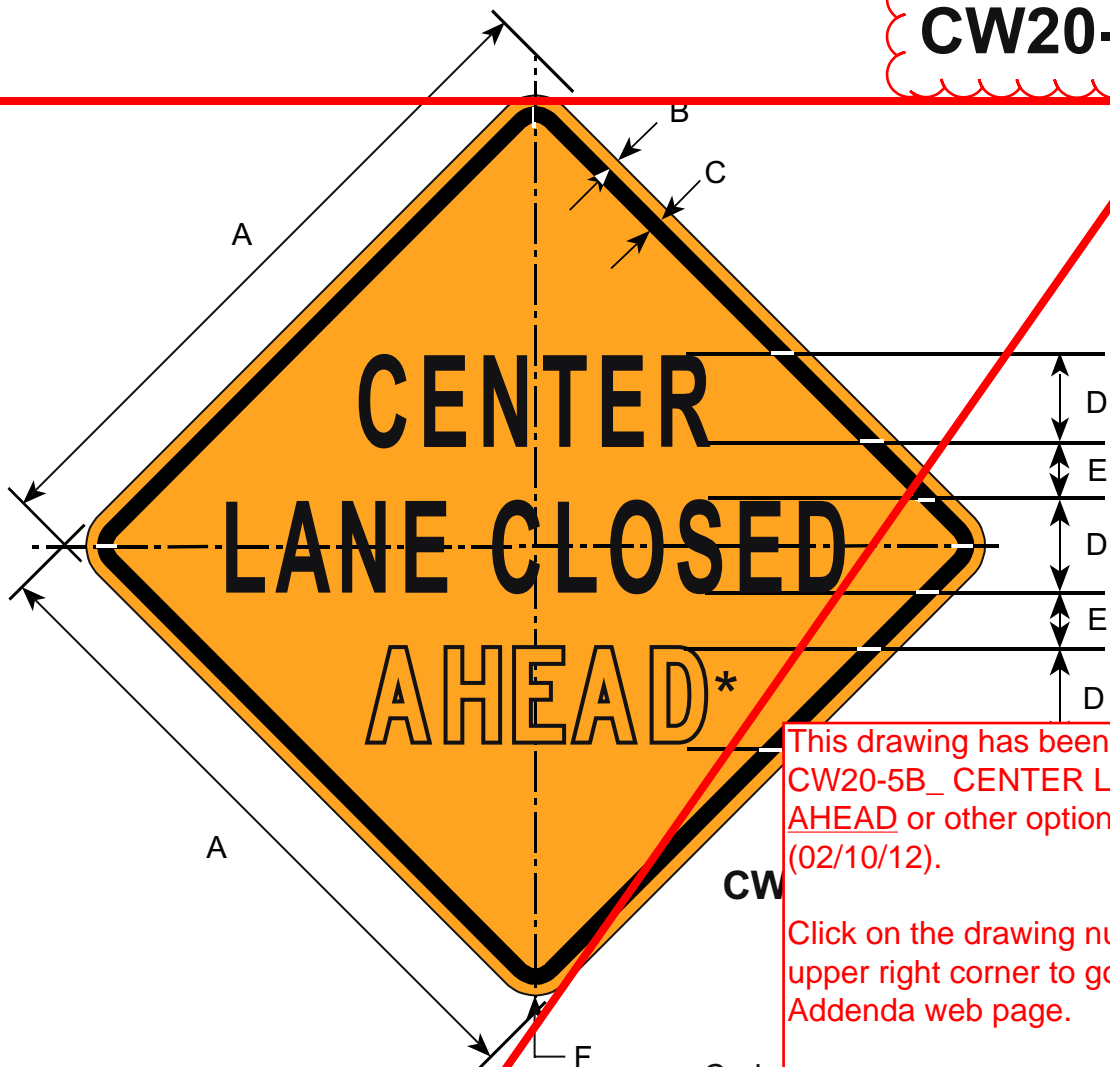

This drawing has been replaced with: CW20-5B_ CENTER LANE CLOSED AHEAD or other optional variations (02/10/12).

Click on the drawing number in the upper right corner to go to the Interim Addenda web page.

CW

Code variable Legend
 A 500 FT
 B 1000 FT
 C 1 MILE
 D 1/2 MILE
 E 1500 FT
 F AHEAD
 Example: CW20-5AF refers to "RIGHT TWO LANES CLOSED AHEAD".

Border and Legend: Black
 Background: Orange

Road Class	Dimensions (inches)					
	A	B	C	D	E	F
Minimum	36	0.63	0.88	5C	2.75	2.25
Conventional	48	0.75	1.25	6C	3.38	3.0
Expwy/Fwy	60	1.0	1.5	8C	5.2	3.75

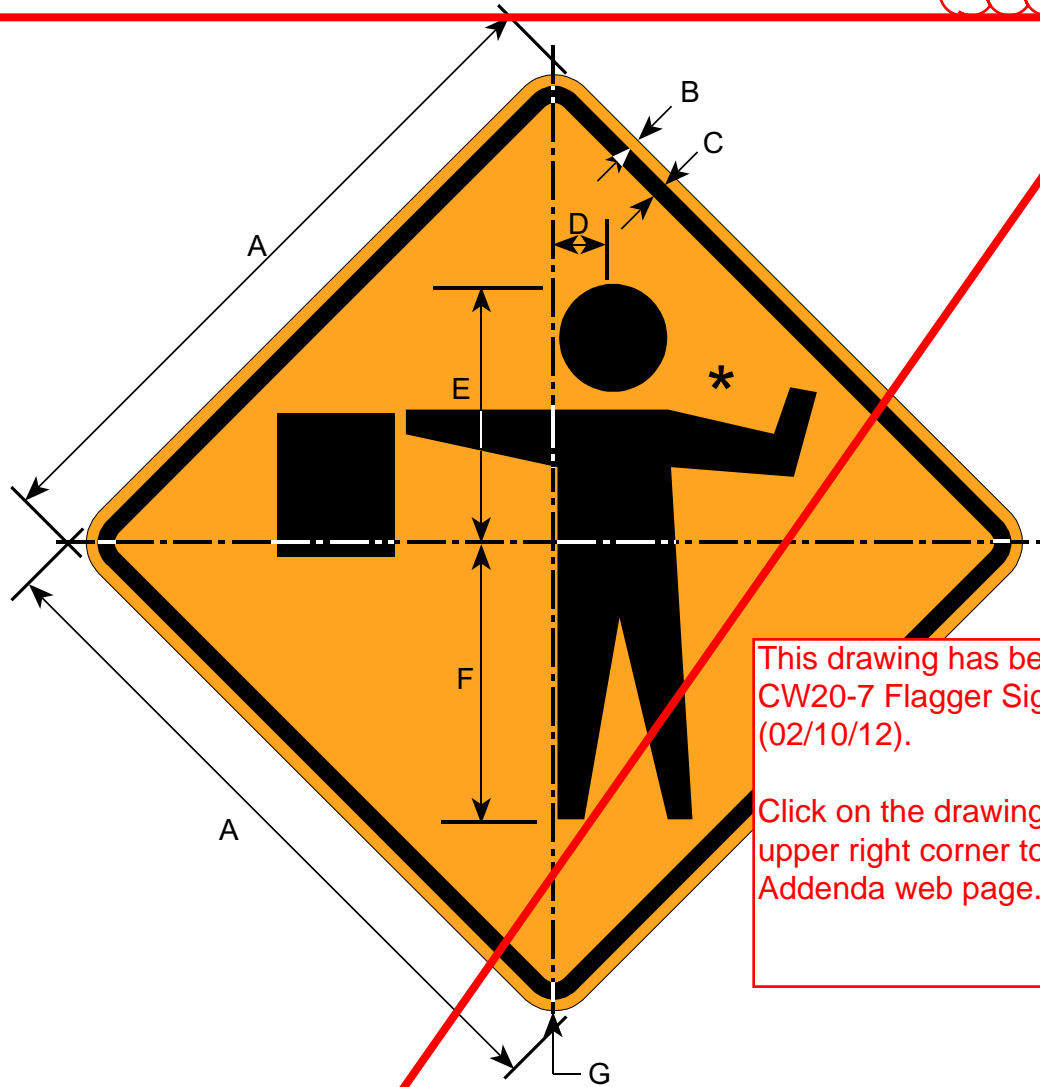

This drawing has been replaced with:
 CW20-7 Flagger Sign (Symbol)
 (02/10/12).
 Click on the drawing number in the
 upper right corner to go to the Interim
 Addenda web page.

*Make symbol proportional
 to the graphic shown.

Border and Legend: Black
 Background: Orange

Class	A	B	C	D	E	F	G
Minimum	36	0.63	0.88	2.75	13.5	14.63	2.25
Conventional	48	0.75	1.25	3.75	18.0	19.50	3.00
Expwy/Fwy	60	1.00	1.50	4.75	22.0	24.50	3.75

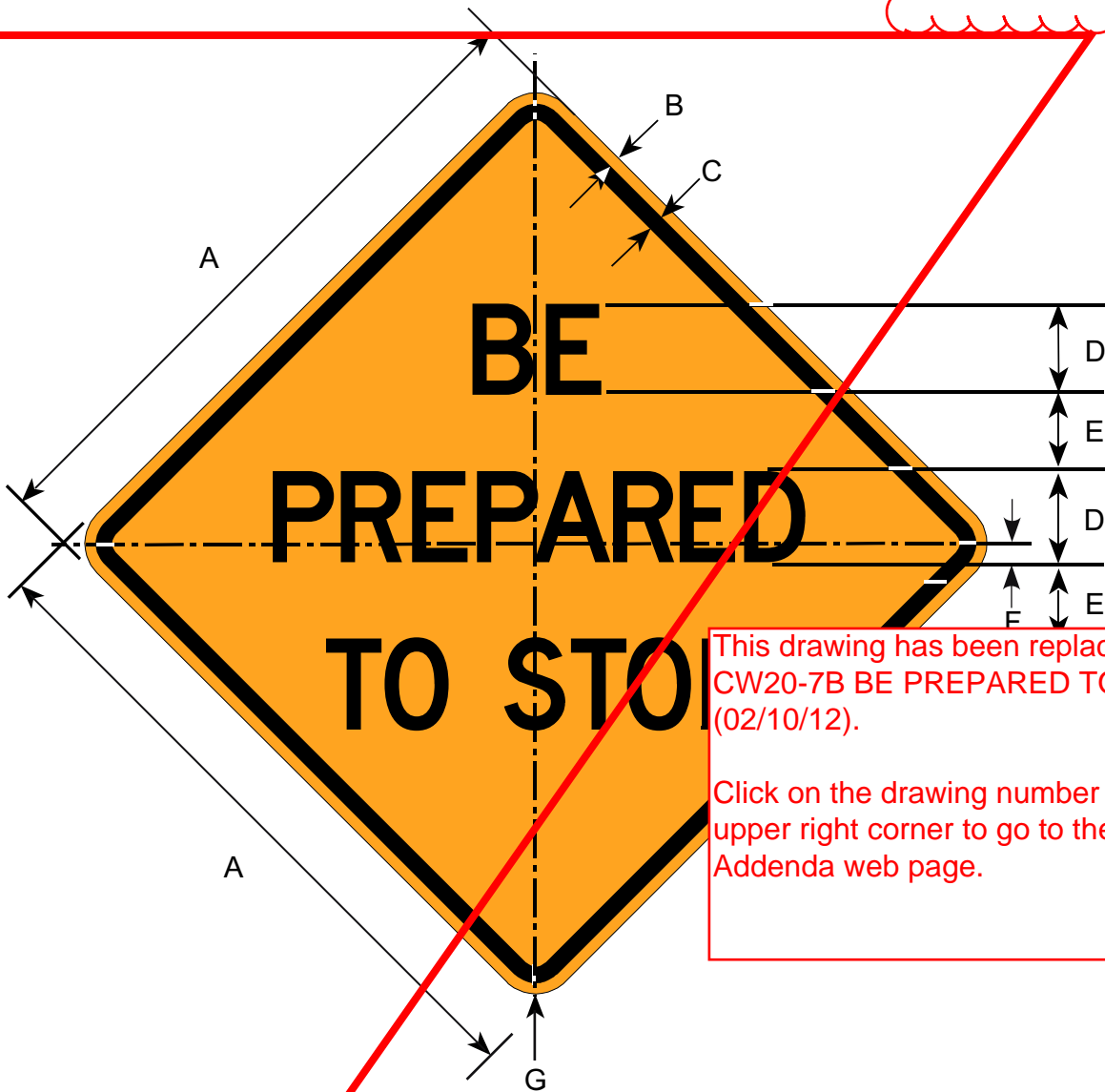

This drawing has been replaced with:
CW20-7B BE PREPARED TO STOP
 (02/10/12).

Click on the drawing number in the
 upper right corner to go to the Interim
 Addenda web page.

Border and Legend: Black
 Background: Orange

Prior to the 2003 revision of this manual this sign was
 numbered CW20-8.

Road Class	Dimensions (inches)						
	A	B	C	D	E	F	G
Minimum	36	0.63	0.88	6C	3.6	0.92	2.25
Conventional	48	0.75	1.25	8C	4.8	1.20	3.00
Expwy/Fwy	60	0.75	1.25	9C	5.4	1.40	3.00

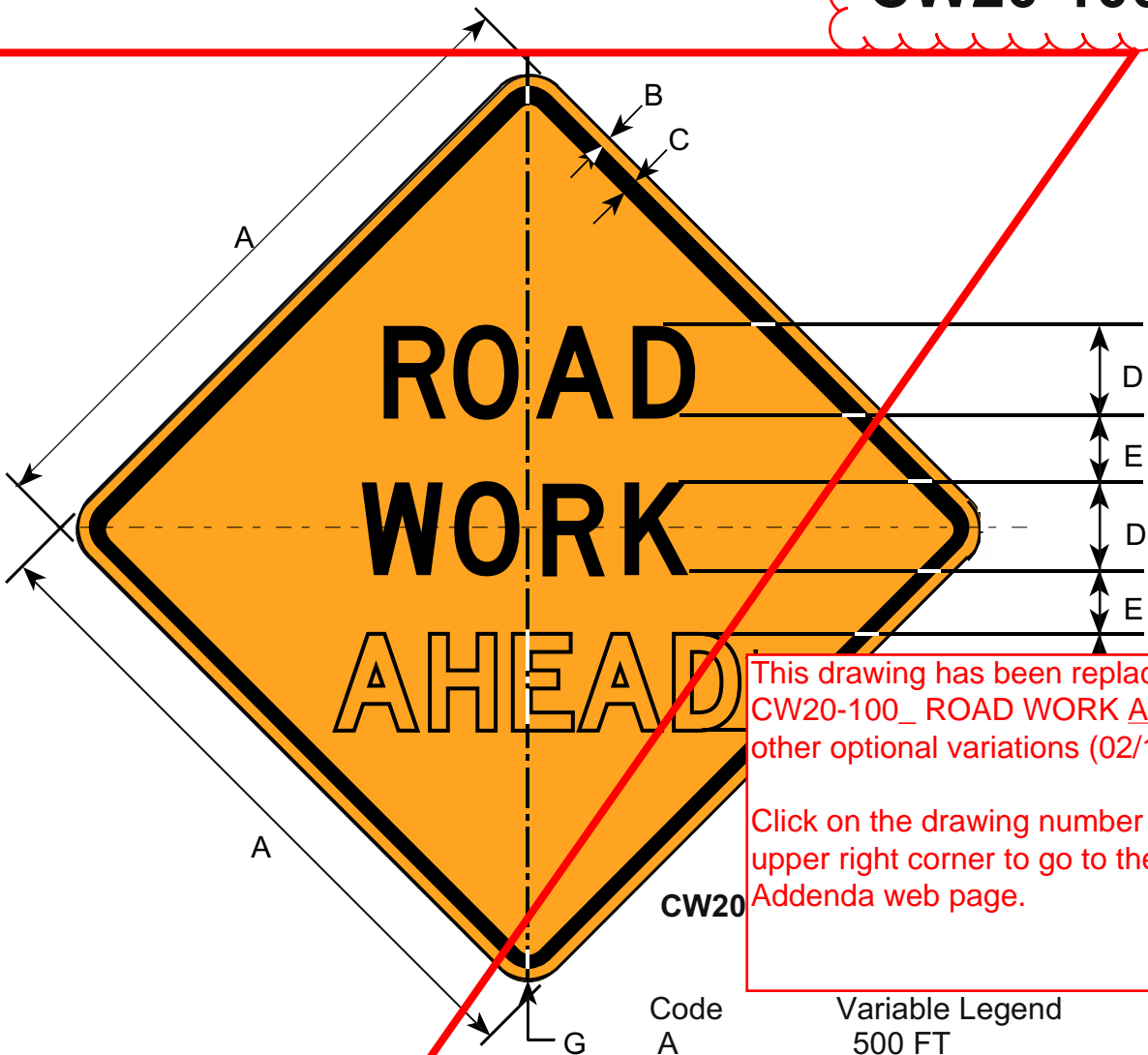

This drawing has been replaced with: CW20-100_ ROAD WORK AHEAD or other optional variations (02/10/12).
 Click on the drawing number in the upper right corner to go to the Interim Addenda web page.

Border and Legend: Black
 Background: Orange

- Code** **Variable Legend**
- A 500 FT
 - B 1000 FT
 - C 1 MILE
 - D 1/2 MILE
 - E 1500 FT
 - F AHEAD
- Example: CW20-100F refers to "ROAD WORK AHEAD"

Prior to the 2002 publication of this manual, this sign was numbered CW21-4_.

Road Class	Dimensions (inches)						
	A	B	C	D	E	F	G
Minimum	36	0.63	0.88	5D	3.63	2.5	2.25
Conventional	48	0.75	1.25	7D	4.75	3.5	3.0
Expwy/Fwy	60	1.0	1.5	8D	5.5	4.0	3.75

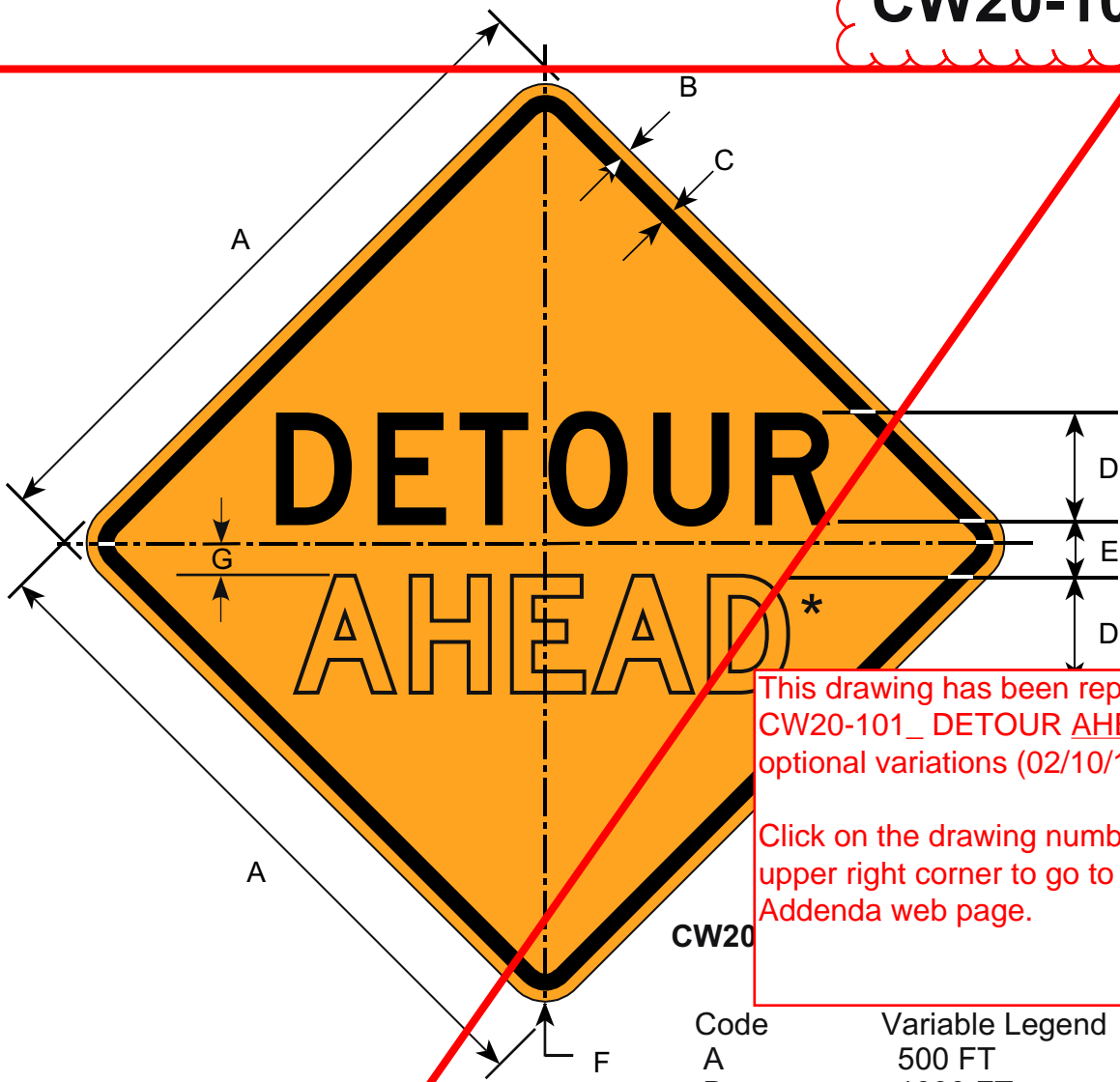

This drawing has been replaced with: CW20-101_ DETOUR AHEAD or other optional variations (02/10/12).

Click on the drawing number in the upper right corner to go to the Interim Addenda web page.

Border and Legend: Black
Background: Orange

Code	Variable Legend
A	500 FT
B	1000 FT
C	1 MILE
D	1/2 MILE
E	1500 FT
F	AHEAD
Example: CW20-101F refers to "DETOUR AHEAD"	

Prior to the 2002 publication of this manual, this sign was numbered CW21-2_.

Road Class	Dimensions (inches)						
	A	B	C	D	E	F	G
Minimum	36	0.63	0.88	6D	3.5	2.25	2.63
Conventional	48	0.75	1.25	8D	4.75	3.0	3.5
Expwy/Fwy	60	1.0	1.5	10D	6.0	4.0	4.42

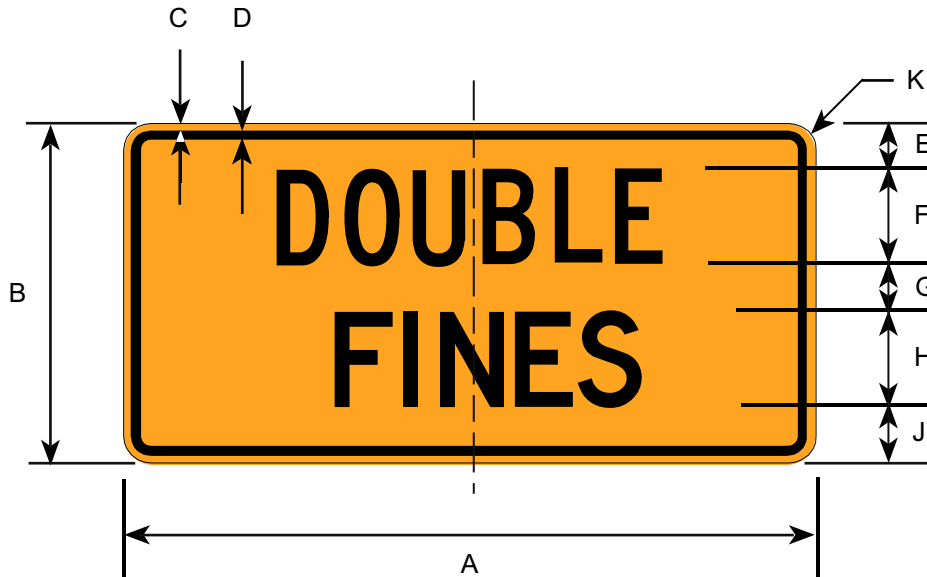

Border and Legend: Black
Background: Orange

Prior to the 2003 revision of this manual this sign was numbered AK-CW20-100.

Road Class	Dimensions (inches)									
	A	B	C	D	E	F	G	H	J	K
Conventional	30	18	0.50	0.75	2.5	5C	2.5	5D	3	1.88
Expressway	36	24	0.63	0.88	4.0	6C	4.0	6D	4	2.25
Freeway	48	30	0.75	1.25	6.0	6D	6.0	6D	6	3.00

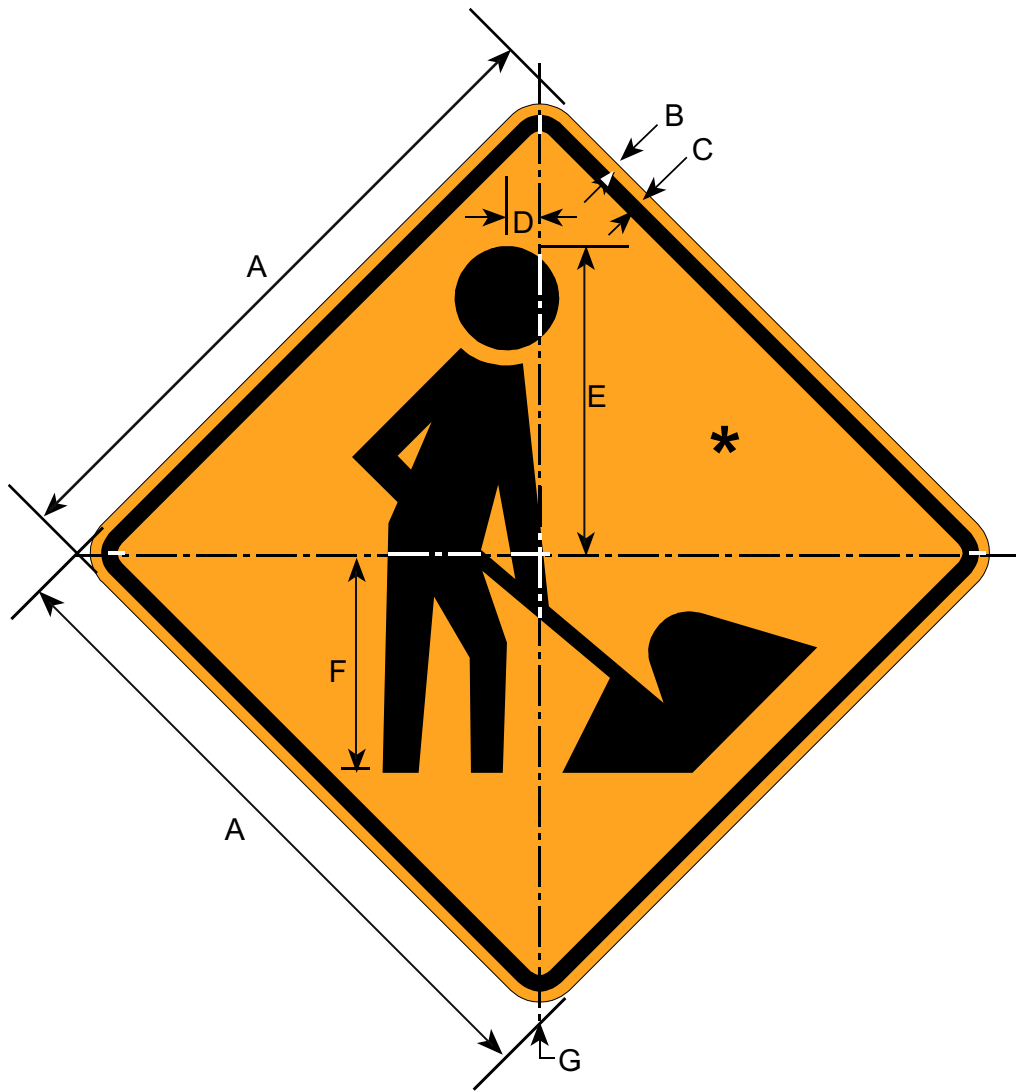

*Make symbol proportional to the graphic shown.

Border and Legend: Black
Background: Orange

Road Class	Dimensions (inches)						
	A	B	C	D	E	F	G
Minimum	30	0.50	0.75	1.88	14.00	10	1.88
Conventional	36	0.63	0.88	2.25	16.88	12	2.25
Expwy/Fwy	48	0.75	1.25	3.00	22.38	16	3.00

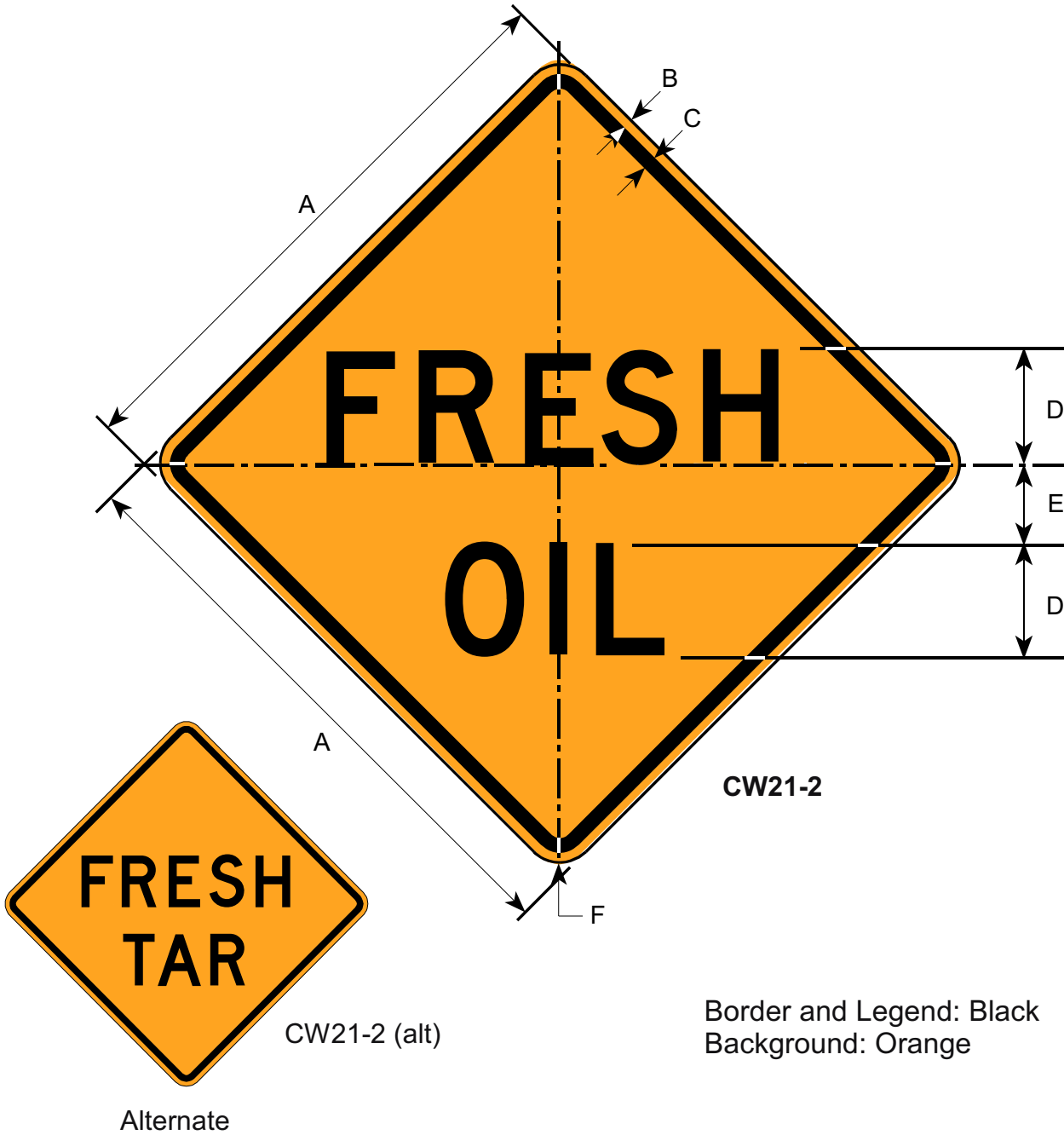

CW21-2

CW21-2 (alt)

Border and Legend: Black
Background: Orange

Class	A	B	C	D	E	F
Minimum	30	0.50	0.75	6D	4.0	1.88
Conventional	36	0.63	0.88	7D	5.0	2.25
Expwy/Fwy	48	0.88	1.13	9D	7.0	3.0

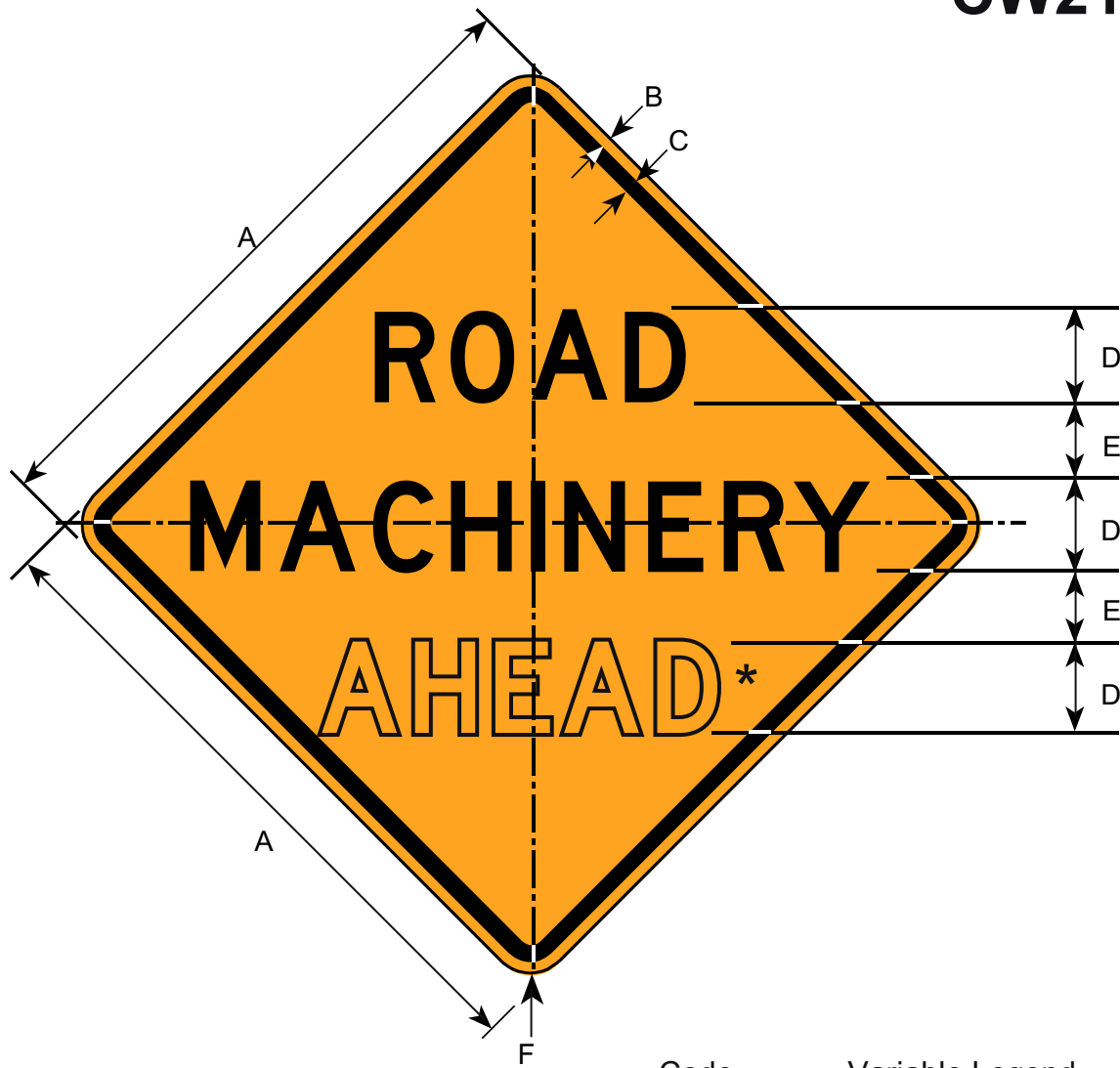

Border and Legend: Black
Background: Orange

Code	Variable Legend
A	500 FT
B	1000 FT
C	1 MILE
D	1/2 MILE
E	1500 FT
F	AHEAD

Example: CW21-3F refers to "ROAD MACHINERY AHEAD"

Road Class	Dimensions (inches)					
	A	B	C	D	E	F
Minimum	30	0.50	0.75	4D	3.5	1.88
Conventional	36	0.63	0.88	5D	4.0	2.25
Expwy/Fwy	48	0.75	1.25	7D	5.0	3.0

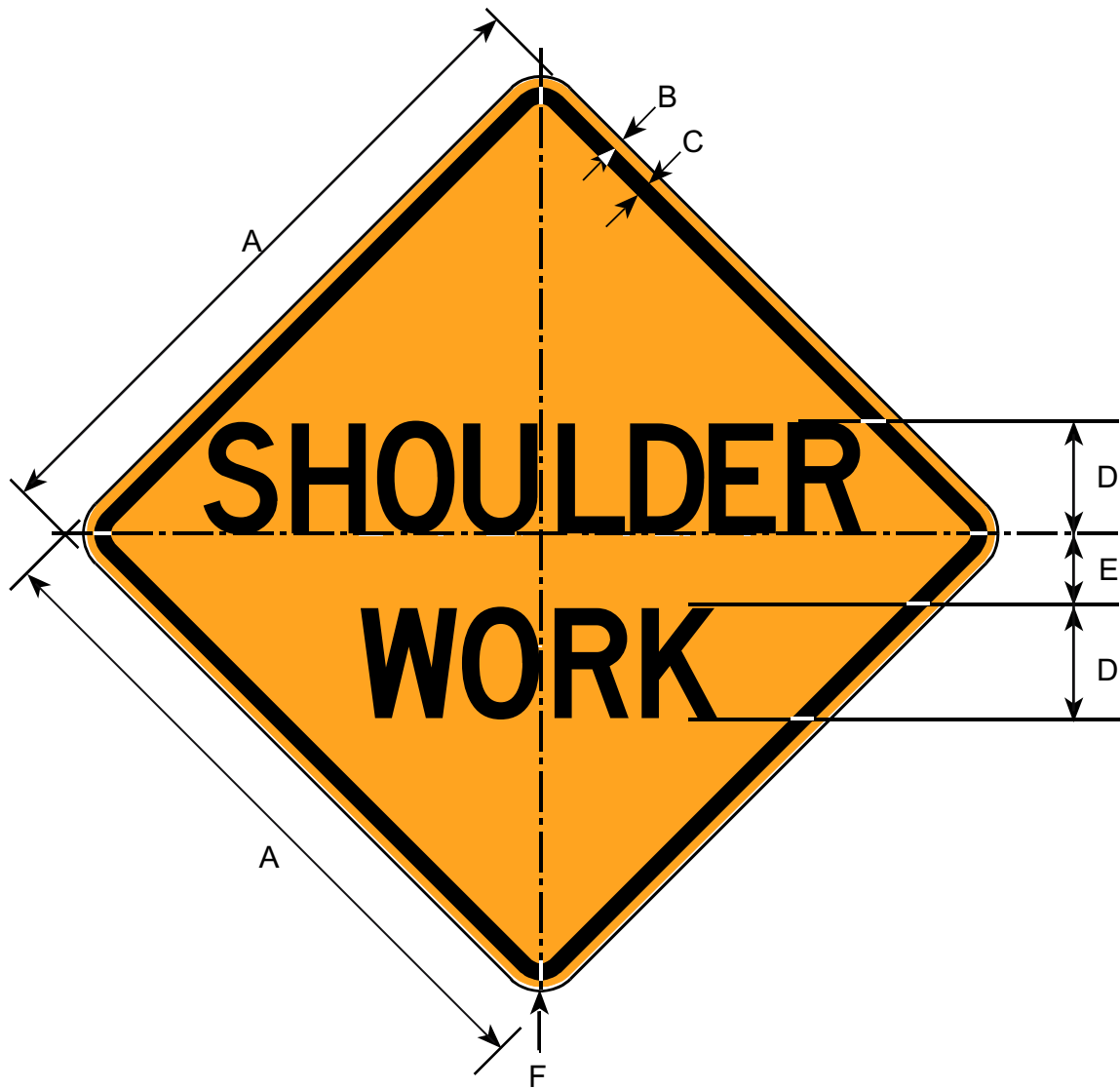

Border and Legend: Black
 Background: Orange

Road Class	Dimensions (inches)					
	A	B	C	D	E	F
Minimum	30	0.50	0.75	5C	3.0	1.88
Conventional	36	0.63	0.88	6C	3.5	2.25
Expwy/Fwy	48	0.75	1.25	8C	4.5	3.00

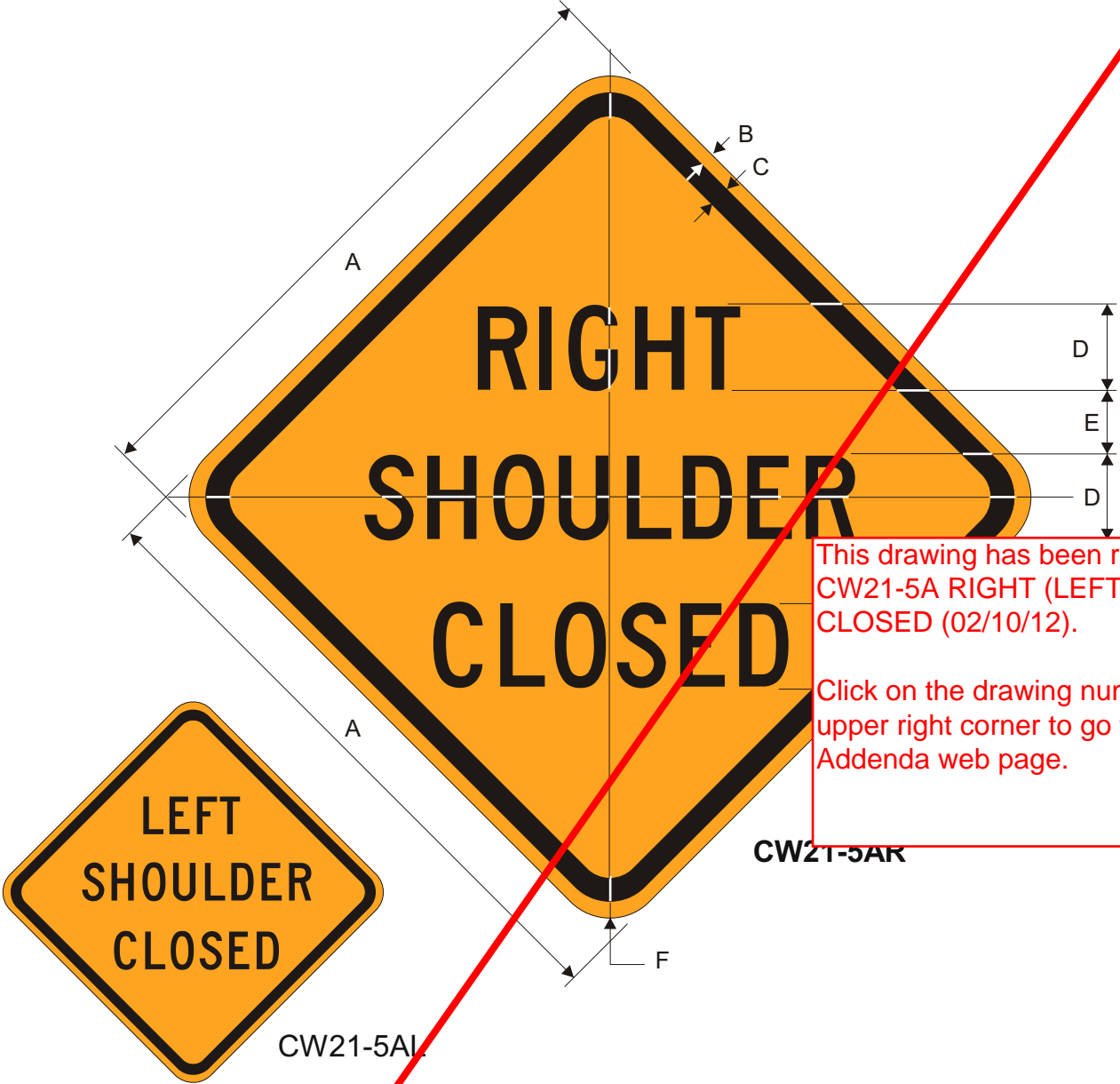

This drawing has been replaced with:
 CW21-5A RIGHT (LEFT) SHOULDER
 CLOSED (02/10/12).
 Click on the drawing number in the
 upper right corner to go to the Interim
 Addenda web page.

CW21-5AR

CW21-5AL

Border and Legend: Black
 Background: Orange

Road Class	Dimensions (inches)					
	A	B	C	D	E	F
Minimum	36	0.63	0.88	5C	3.68	2.25
Conventional	48	0.75	1.25	7C	4.8	3.0
Expwy/Fwy	60	0.75	1.25	8C	5.48	3.0

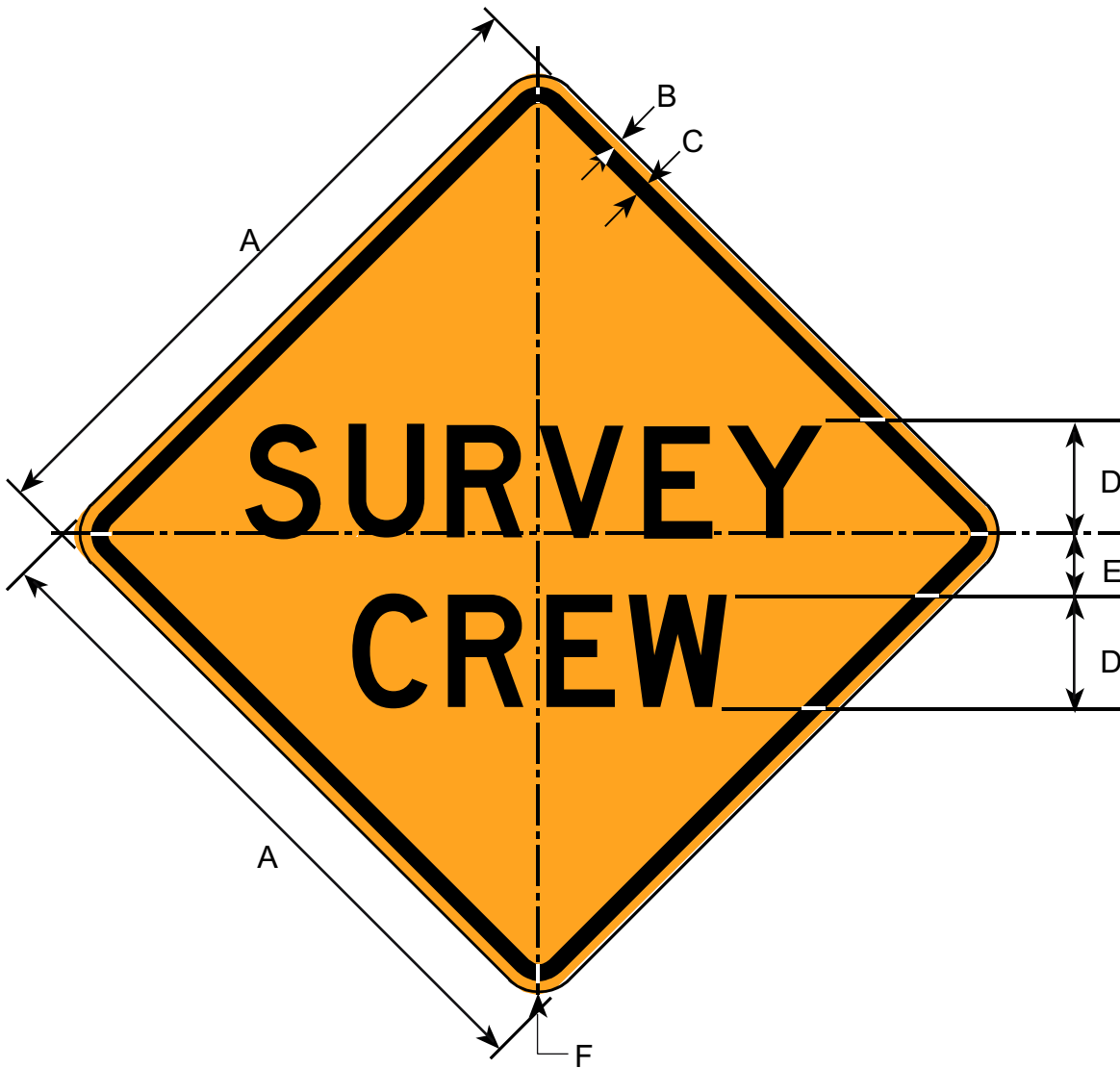

Border and Legend: Black
Background: Orange

Road Class	Dimensions (inches)					
	A	B	C	D	E	F
Minimum	30	0.50	0.75	5D	3.0	1.88
Conventional	36	0.63	0.88	6D	3.5	2.25
Expwy/Fwy	48	0.75	1.25	8D	4.5	3.00

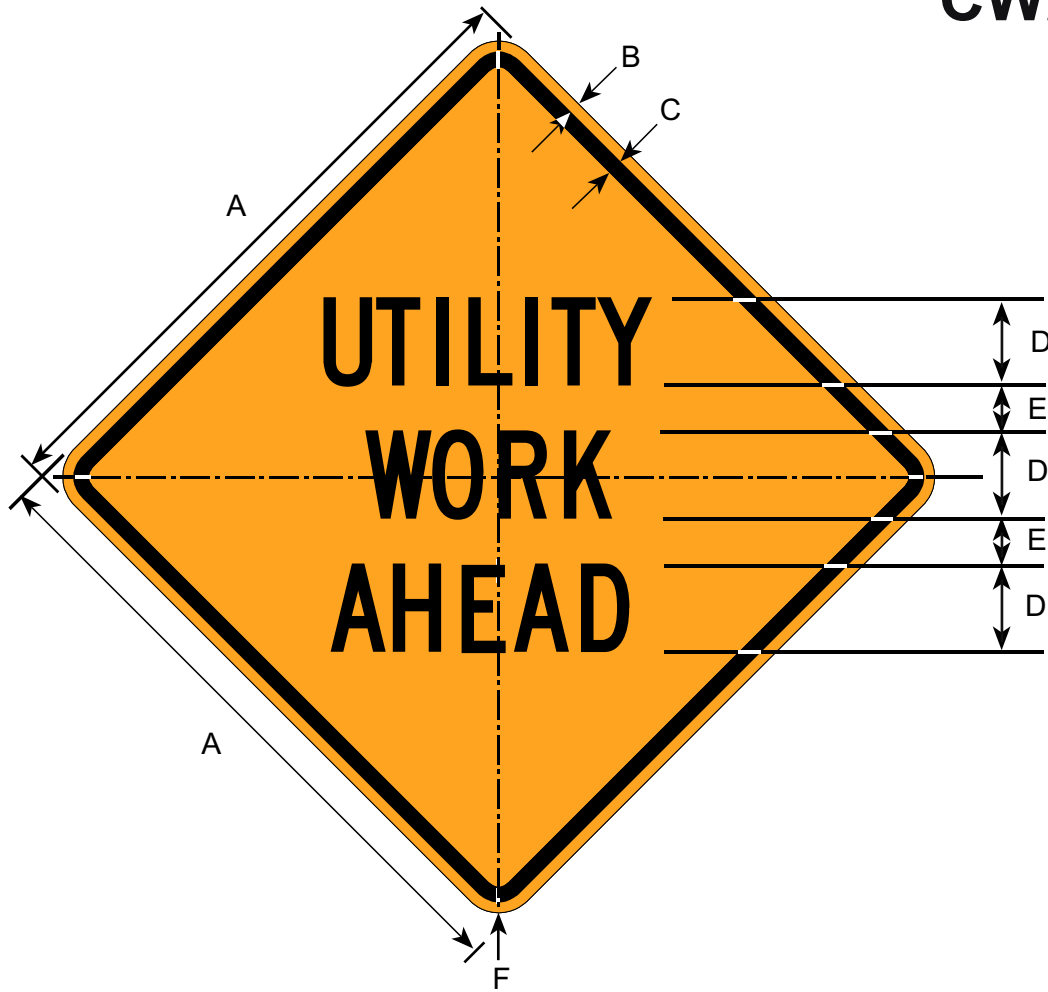

Border and Legend: Black
 Background: Orange

Road Class	Dimensions (inches)					
	A	B	C	D	E	F
Minimum	30	0.50	0.75	5C	3.0	1.88
Conventional	36	0.63	0.88	5C	3.3	2.25
Expwy/Fwy	48	0.75	1.25	6C	4.0	3.00

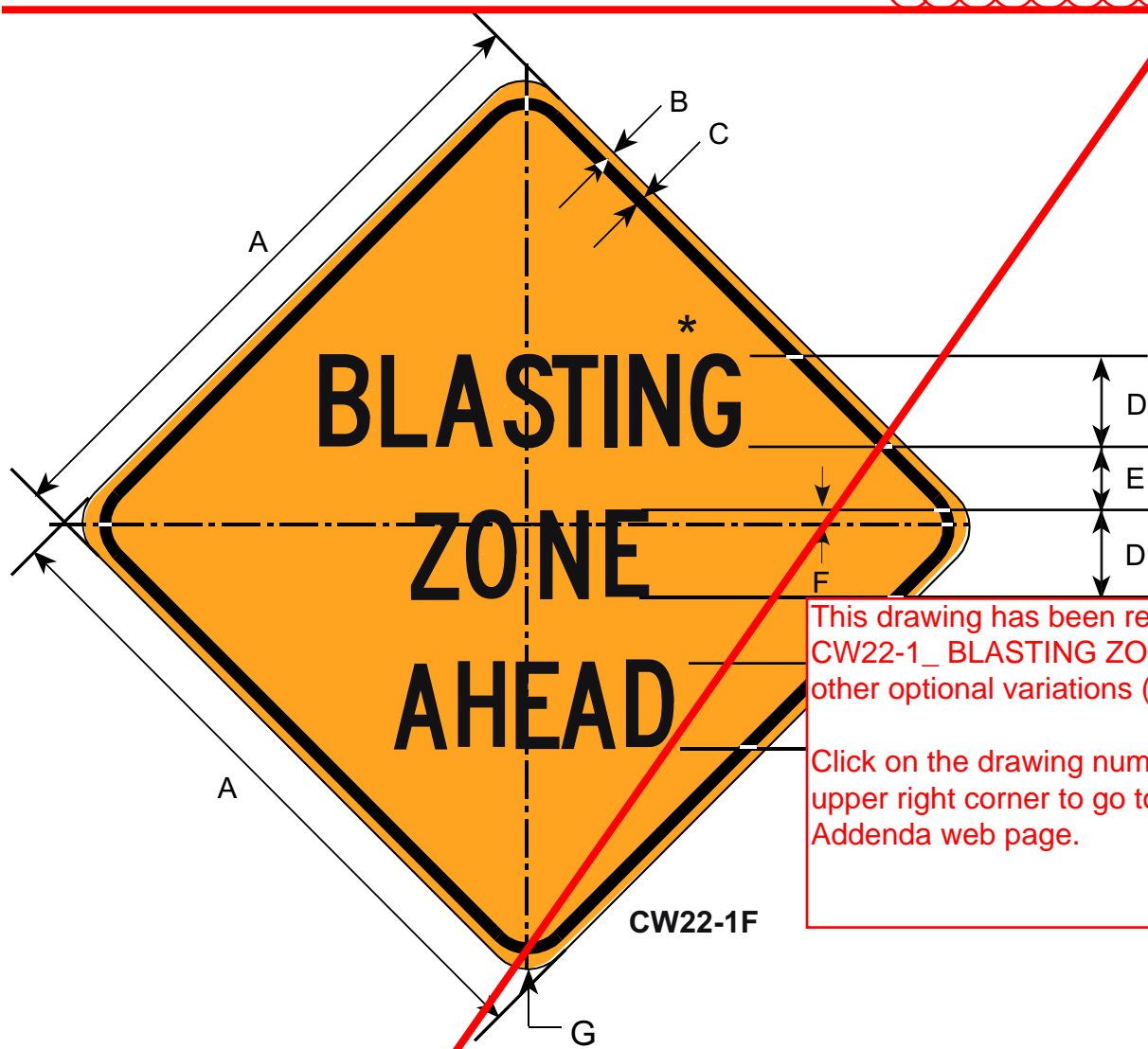

This drawing has been replaced with:
CW22-1_ BLASTING ZONE AHEAD or
 other optional variations (02/10/12).
 Click on the drawing number in the
 upper right corner to go to the Interim
 Addenda web page.

CW22-1F

This sign replaces former BLASTING ZONE 1000 FT (CW22-100) sign.

Border and Legend: Black
 Background: Orange

* Reduce spacing 40%

Code	Variable Legend
A	500 FT
B	1000 FT
C	1 MILE
D	1/2 MILE
E	1500 FT
F	AHEAD

Example: CW22-1A refers to
 "BLASTING ZONE 500 FT"

Road Class	Dimensions (inches)						
	A	B	C	D	E	F	G
Minimum	36	0.63	0.88	5C	3.0	1.0	2.25
Conventional	48	0.75	1.25	7C	4.0	1.5	3.0
Expwy/Ewy	60	1.0	1.5	8C	6.0	2.0	3.75

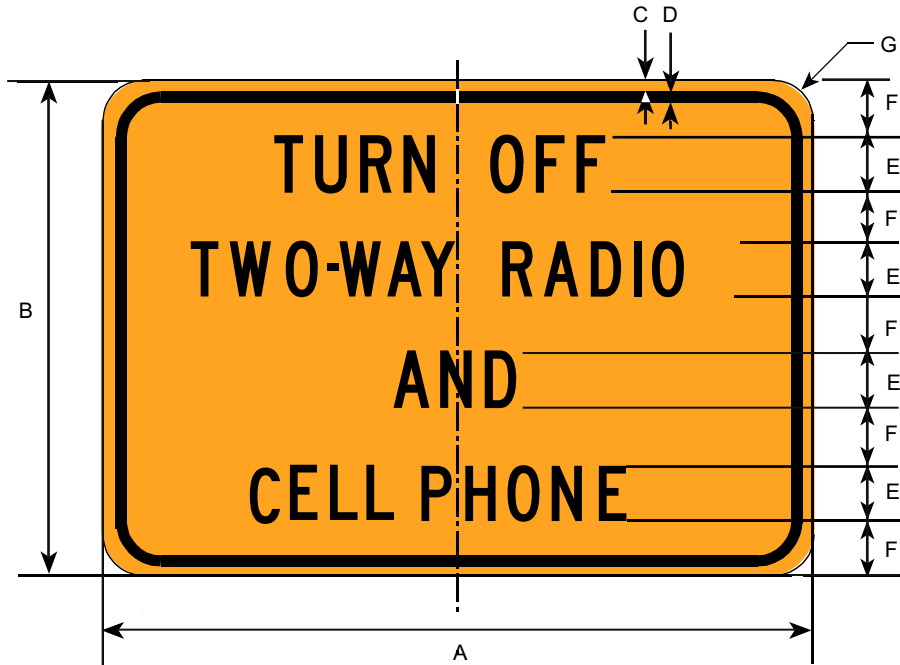

Border and Legend: Black
 Background: Orange

Road Class	Dimensions (inches)						
	A	B	C	D	E	F	G
Conv & Min	42	36	0.63	0.88	4C	4	2

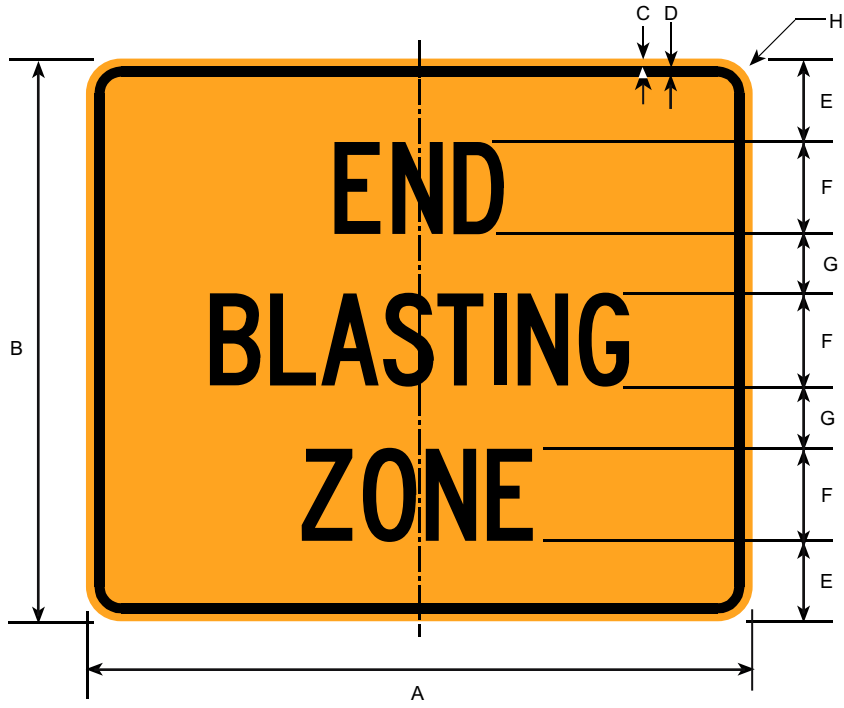

Border and Legend: Black
 Background: Orange

Road Class	Dimensions (inches)							
	A	B	C	D	E	F	G	H
Minimum	36	30	0.50	0.75	4.5	5C	3.0	1.88
Conventional	42	36	0.63	0.88	4.0	7C	3.5	2.25

CW23-100 (Front)

STOP-SLOW PADDLE *

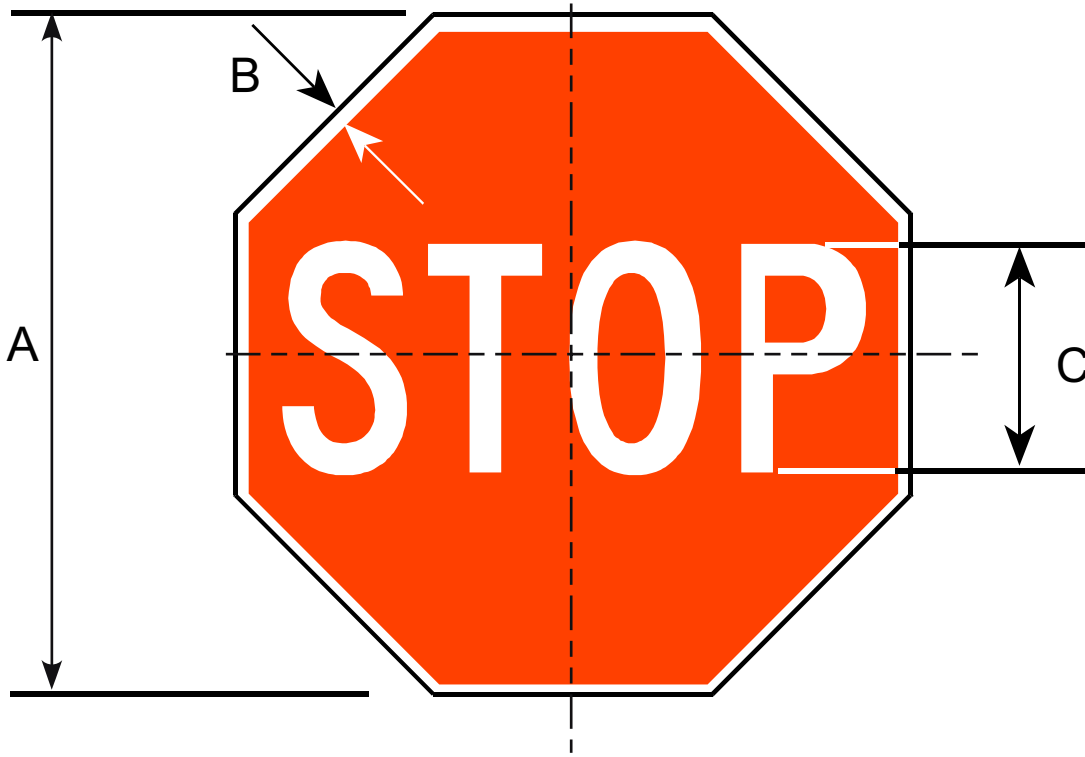

Border and Legend: White
Background: Red

Prior to the 2002 publication of this manual, this sign was numbered CW23-1A.

Road Class	Dimensions (inches)		
	A	B	C
Local Rds w Spd Limits <= 25MPH	18	0.38	6C
All Other Roads	24	0.63	8C

CW23-100 (Back)

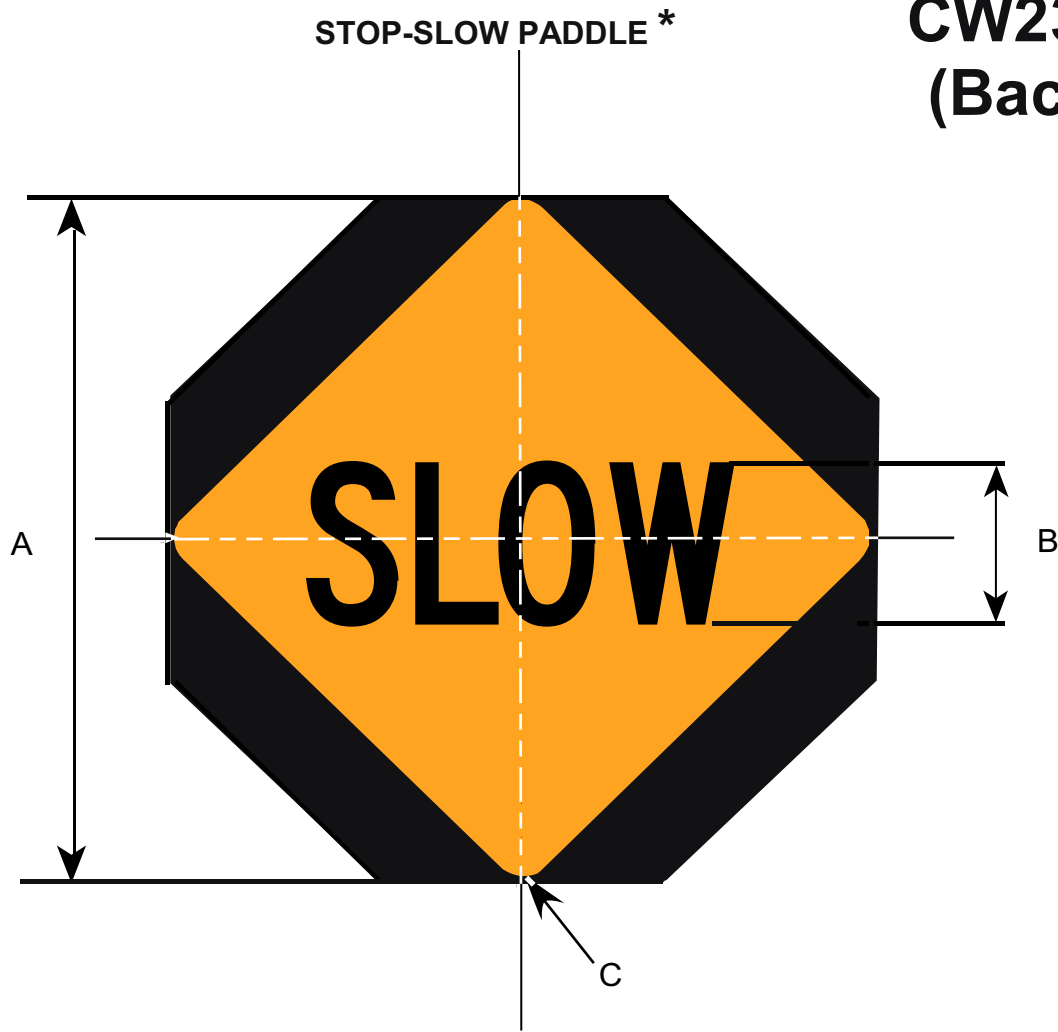

Legend: Black
 Background: Orange
 Area Outside Diamond: Black

Prior to the 2002 publication of this manual, this sign was numbered CW23-1B.

Road Class	Dimensions (inches)		
	A	B	C
Local Rds w Spd Limits <=25MPH	18	6B	1.0
All Other Roads	24	7B	1.25

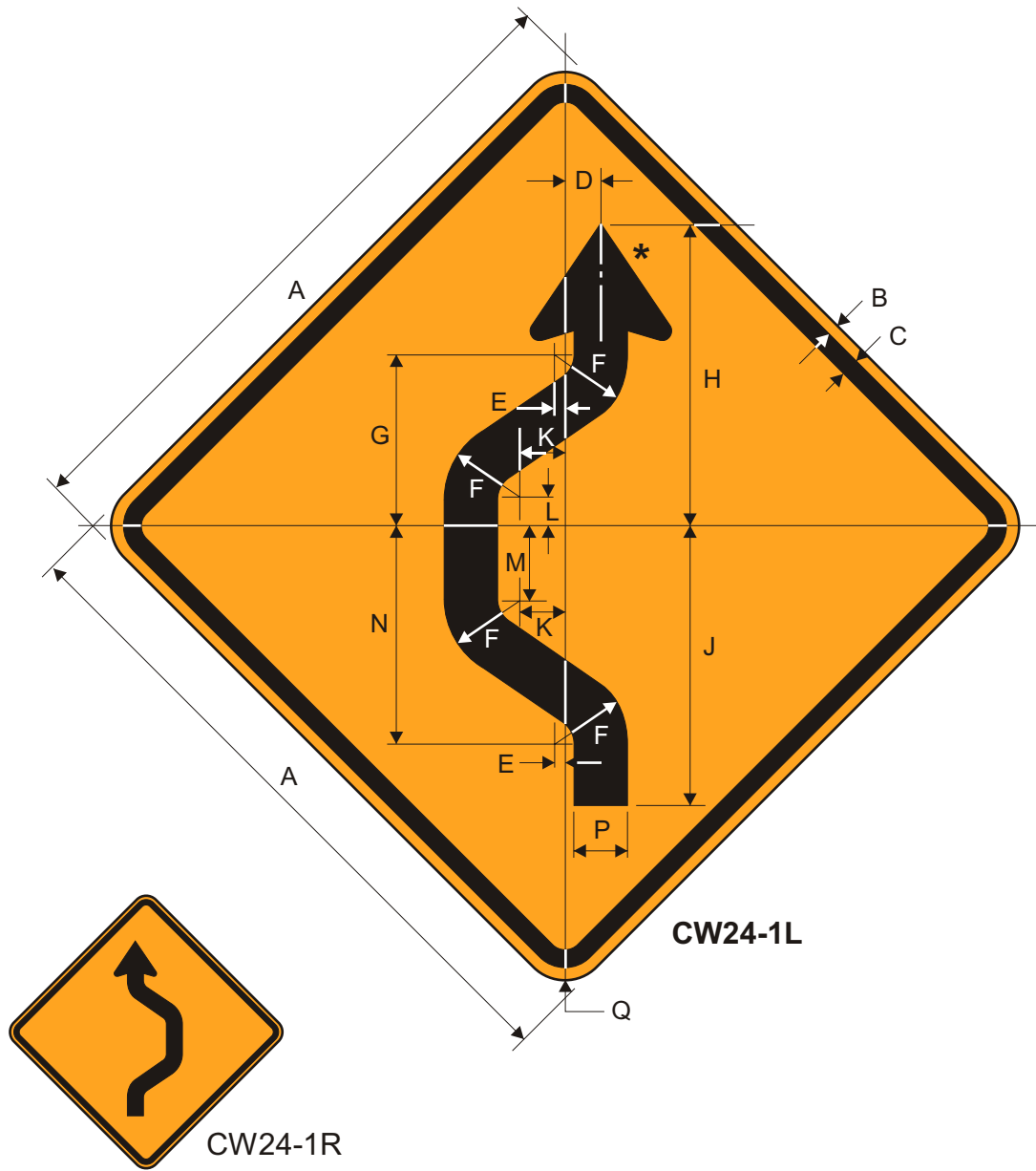

Legend: Black
Background: Orange

* See Appendix B-1 for
Standard Arrow Details.

Road Class	Dimensions (inches)														
	A	B	C	D	E	F	G	H	J	K	L	M	N	P	Q
Minimum	30	0.50	0.75	1.60	0.28	3.08	7.41	13.57	12.57	2.36	1.48	3.52	9.49	2.4	1.88
Conventional	36	0.63	0.88	1.92	0.34	3.7	8.89	16.28	15.08	2.83	1.78	4.23	11.38	2.88	2.25
Expwy/Fwy	48	0.75	1.25	2.56	0.45	4.93	11.85	21.71	20.11	3.78	2.37	5.64	15.18	3.84	3.0

CW24-1A

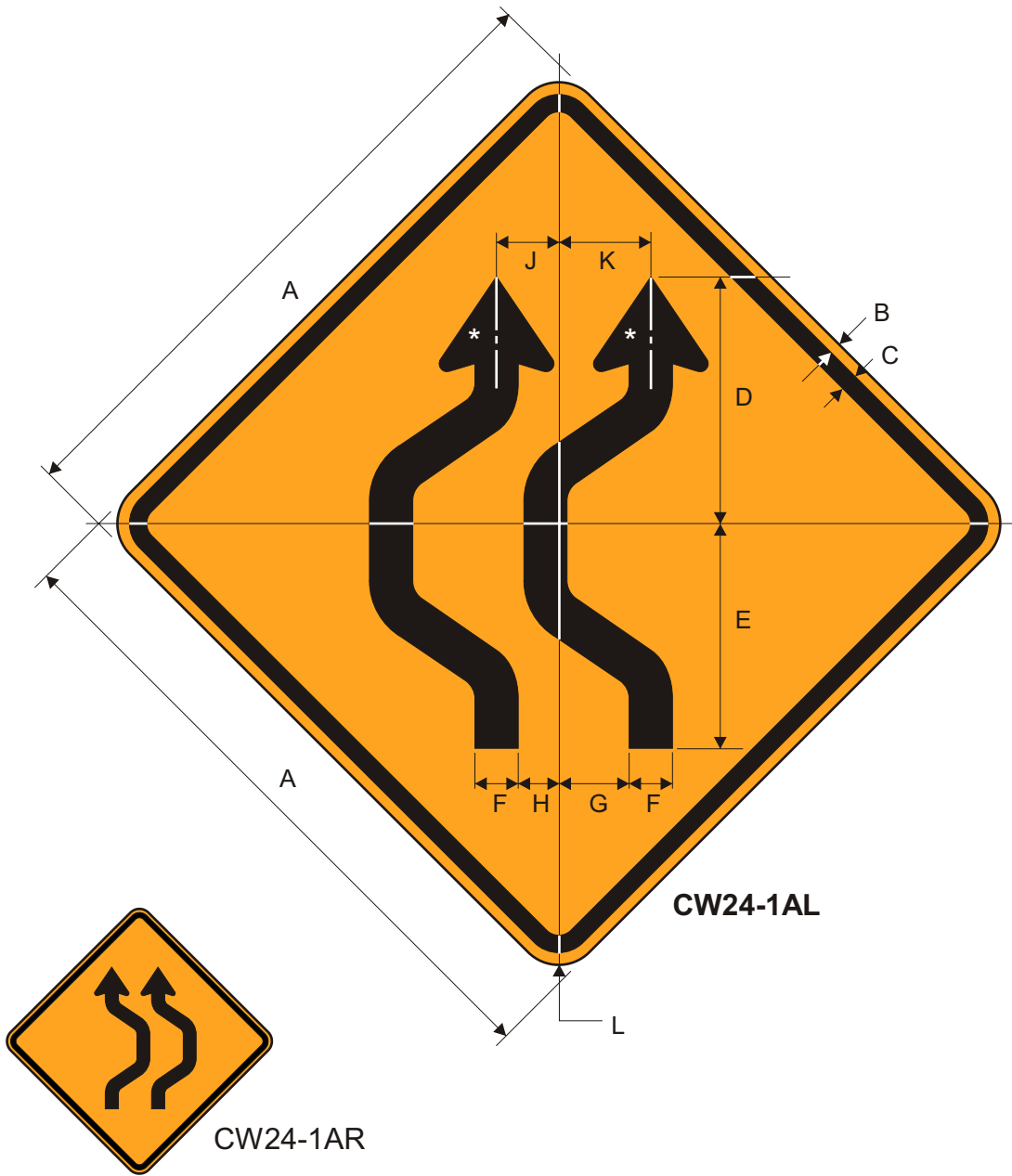

Legend: Black
Background: Orange

*Reduce arrow from CW24-1 15%.

Road Class	Dimensions (inches)										
	A	B	C	D	E	F	G	H	J	K	L
Minimum	30	0.50	0.75	11.53	10.68	2.0	3.24	1.88	2.9	4.26	1.88
Conventional	36	0.63	0.88	13.8	12.82	2.4	3.88	2.24	3.47	5.11	2.25
Expwy/Fwy	48	0.75	1.25	18.46	17.09	3.25	5.2	3.04	4.68	6.83	3.0

CW24-1B

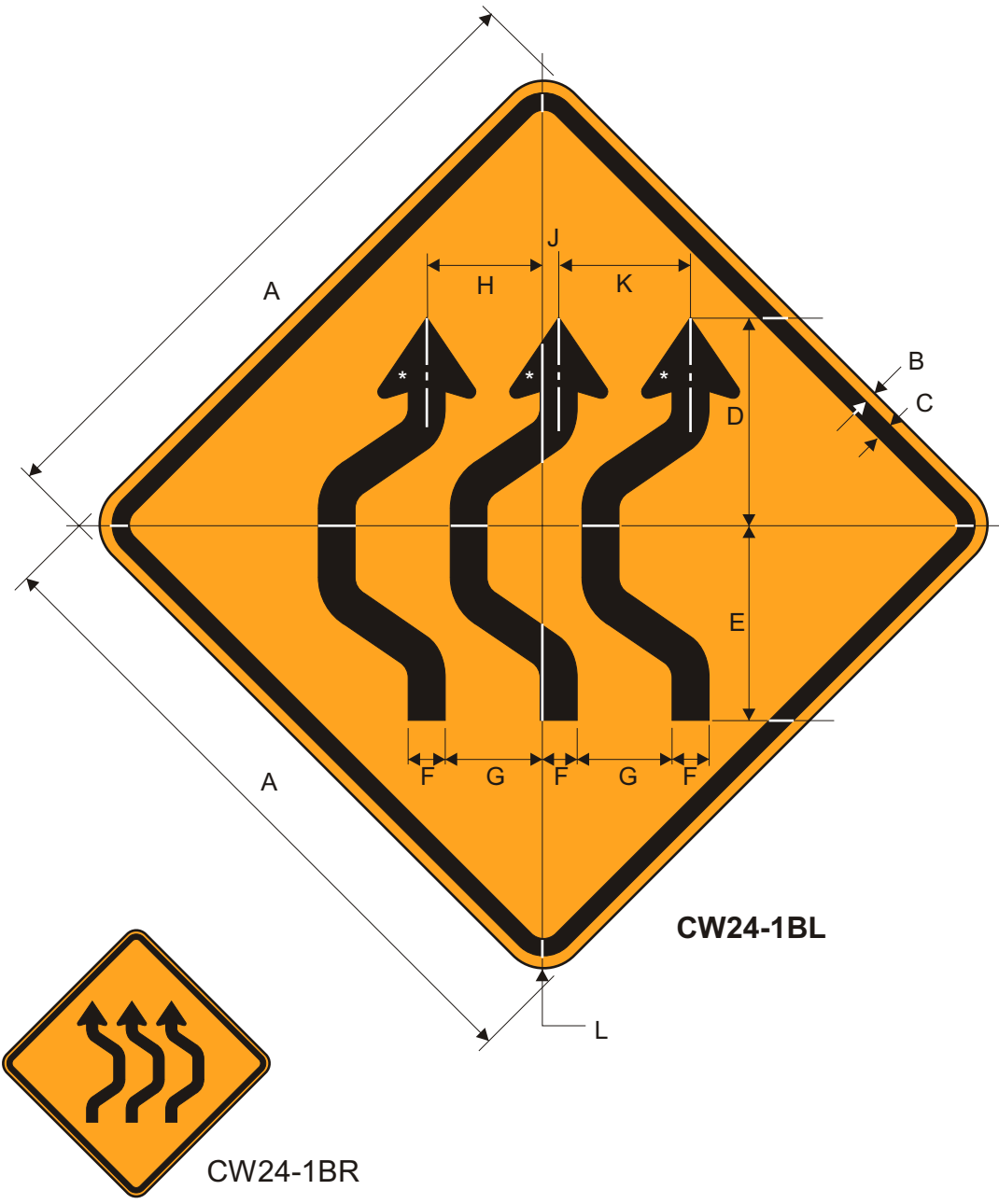

Legend: Black
Background: Orange

*Reduce arrow from CW24-1 30%.

Road Class	Dimensions (inches)										
	A	B	C	D	E	F	G	H	J	K	L
Minimum	30	0.50	0.75	9.49	8.81	1.68	4.72	5.56	0.84	6.4	1.88
Conventional	36	0.63	0.88	11.41	10.57	2.0	5.68	6.69	1.0	7.69	2.25
Expwy/Fwy	48	0.75	1.25	15.17	14.05	2.68	7.53	8.85	1.32	10.21	3.0

DESTINATION SIGNS - CONVENTIONAL RDS

D1-1 to D3-2D

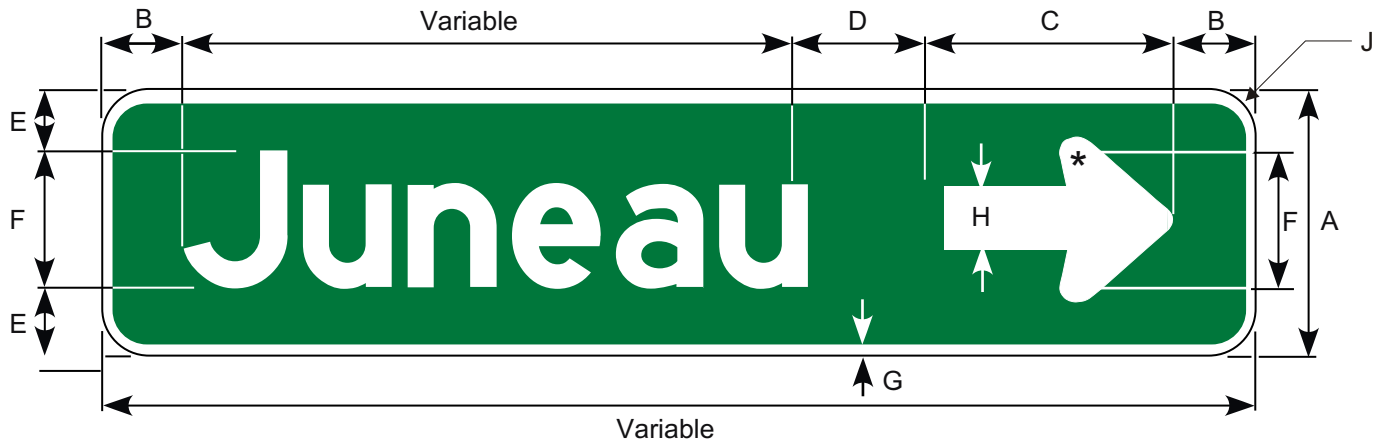

Border and Legend: White
Background: Green

*See Appendix B-1 for Standard Arrow Details.

Letter Size (inches)	Dimensions (inches)								
	A	B	C	D	E	F	G	H	J
6 / 4.5	12	6.0	9.56	6±	3.0	6.0	0.63	2.6	0.75
8 / 6	24	8.0	12.75	8±	8.0	8.0	0.75	3.48	1.5
10.7 / 8	24	11	17.25	11±	6.65	10.7	1.25	4.65	1.5
13.3 / 10	36	13	20.25	13±	11.35	13.3	2.0	5.78	2.25
16 / 12	36	16	25	16±	10	16	2.0	6.96	2.25

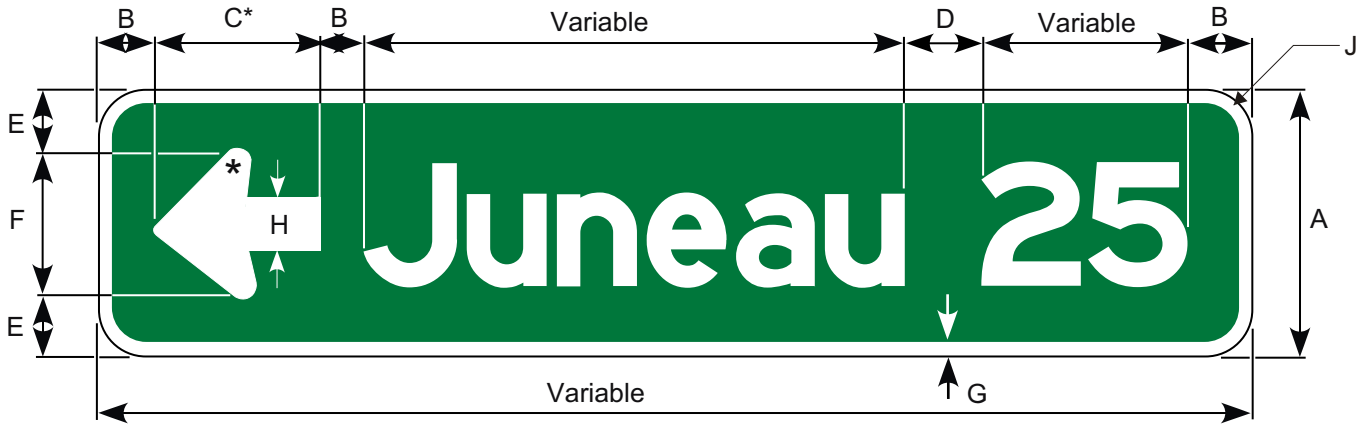

Border and Legend: White
Background: Green

*See Appendix B-1 for Arrow Details.

Letter Size (inches)	Dimensions (inches)								
	A	B	C	D	E	F	G	H	J
6 / 4.5	12	6.0	9.56	6±	3.0	6.0	0.63	2.6	0.75
8 / 6	24	8.0	12.75	8±	8.0	8.0	0.75	3.48	1.5
10.7 / 8	24	11	17.25	11±	6.65	10.7	1.25	4.65	1.5
13.3 / 10	36	13	20.25	13±	11.35	13.3	2.0	5.78	2.25
16 / 12	36	16	25	16±	10	16	2.0	6.96	2.25

D1-100

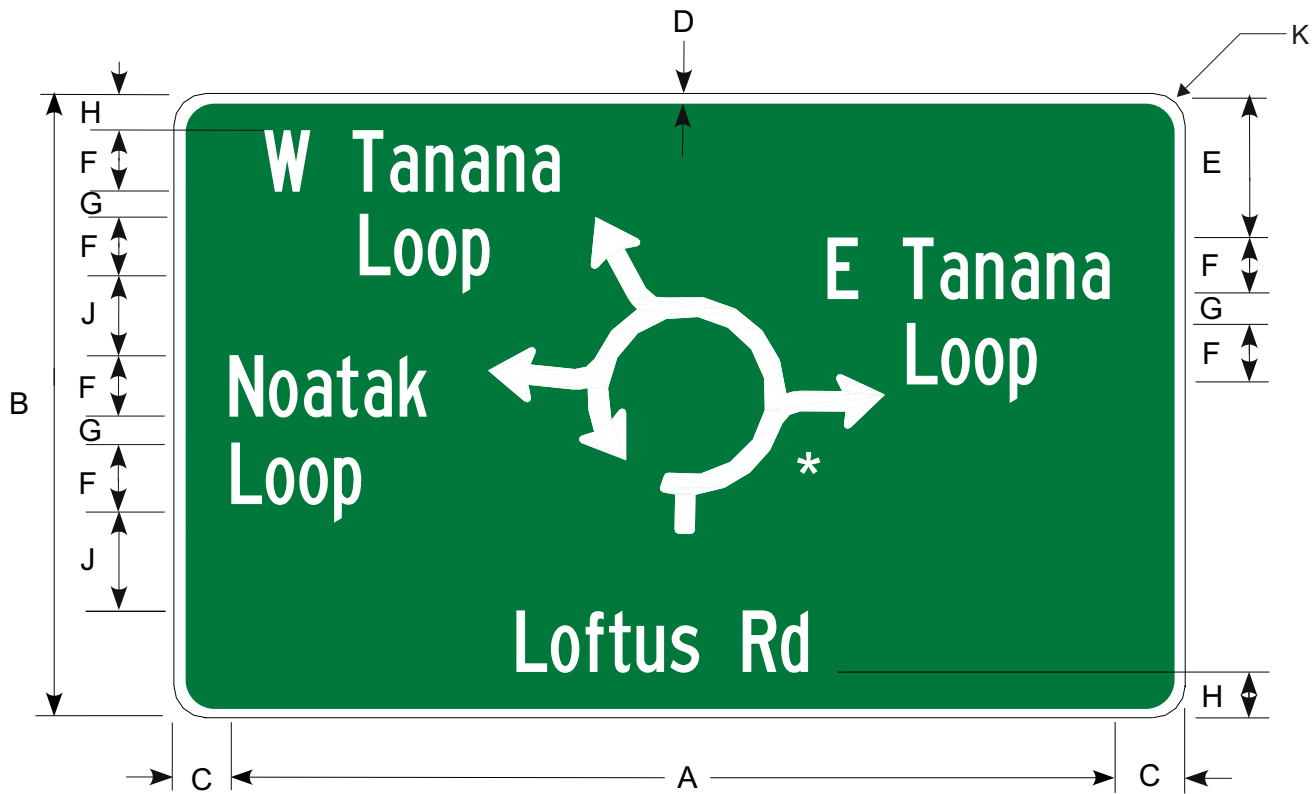

Legend: White
Background: Green

* See Appendix B-1 for Standard Arrow Details.

Letter Size (Inches)	Dimensions (inches)									
	A	B	C	D	E	F	G	H	J	K
6.0 / 4.5	VAR	VAR	6.0	1.5	VAR	6.0	4.0	6.0	Min. 9	VAR
8.0 / 6.0	VAR	VAR	8.0	1.75	VAR	8.0	6.0	8.0	Min. 12	VAR

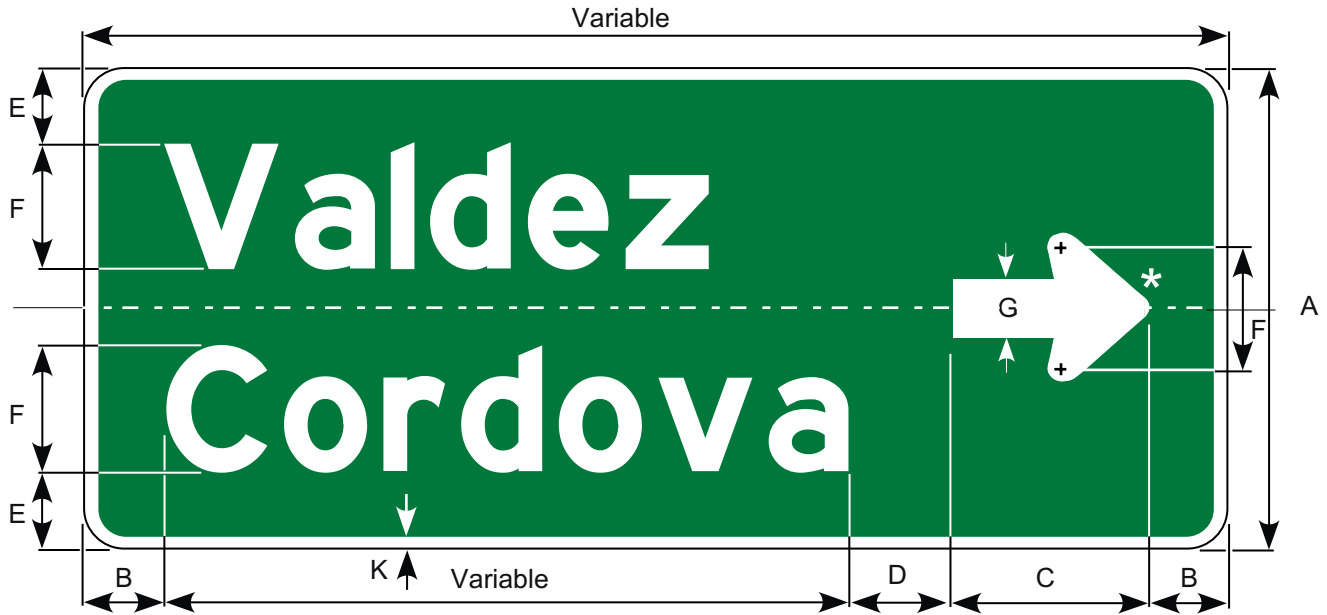

Border and Legend: White
Background: Green

*See Appendix B-1 for Standard Arrow Details.

Prior to the 2002 publication of this manual,
this sign was numbered D1-2.

Letter Size (inches)	Dimensions (inches)							
	A	B	C	D	E	F	G	K
6 / 4.5	24	6.0	9.56	6±	3.0	6.0	2.6	0.75
8 / 6	36	8.0	12.75	8±	7.0	8.0	3.48	1.0
10.7 / 8	48	11	17.25	11±	9.0	10.7	4.65	2.0
13.3 / 10	54	13	20.25	13±	9.5	13.3	5.78	2.0
16 / 12	66	16	25	16±	12	16	6.96	3.0

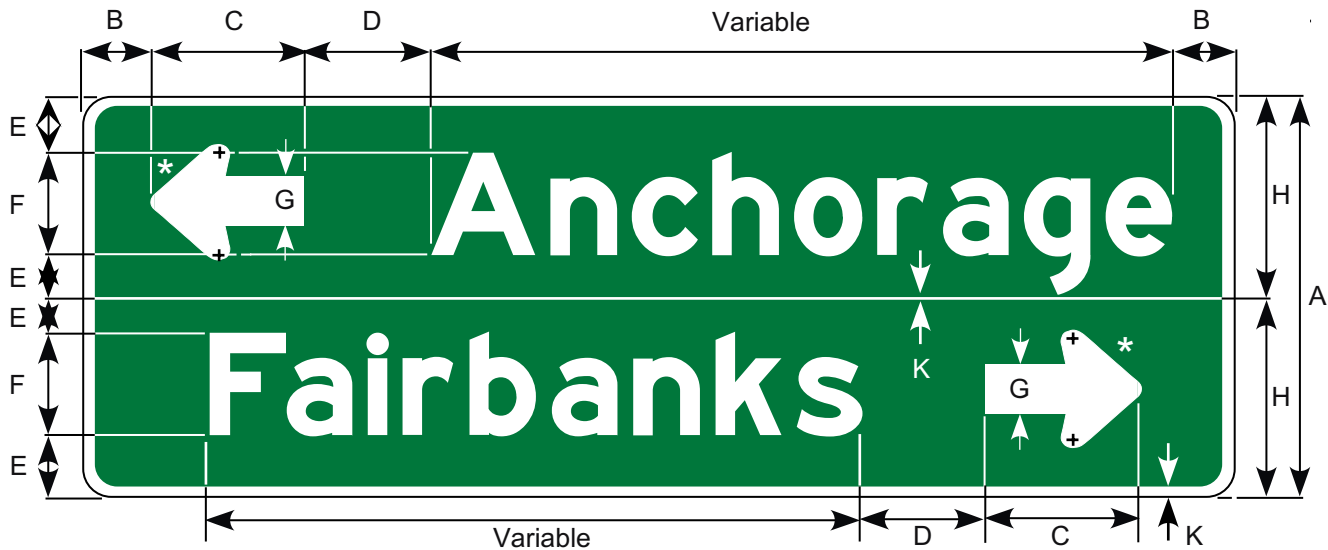

Border and Legend: White
Background: Green

*See Appendix B-1 or Standard Arrow Details.

Prior to the 2002 publication of this manual,
this sign was numbered D1-2.

Letter Size (inches)	Dimensions (inches)								
	A	B	C	D	E	F	G	H	K
6 / 4.5	24	6.0	9.56	6±	3.0	6.0	2.6	12	0.75
8 / 6	42	8.0	12.75	8±	6.25	8.0	3.48	21	1.0
10.7 / 8	54	11	17.25	11±	8.15	10.7	4.65	27	2.0
13.3 / 10	66	13	20.25	13±	9.85	13.3	5.78	33	2.0
16 / 12	78	16	25	16±	11.5	16	6.96	39	3.0

D1-2A-1

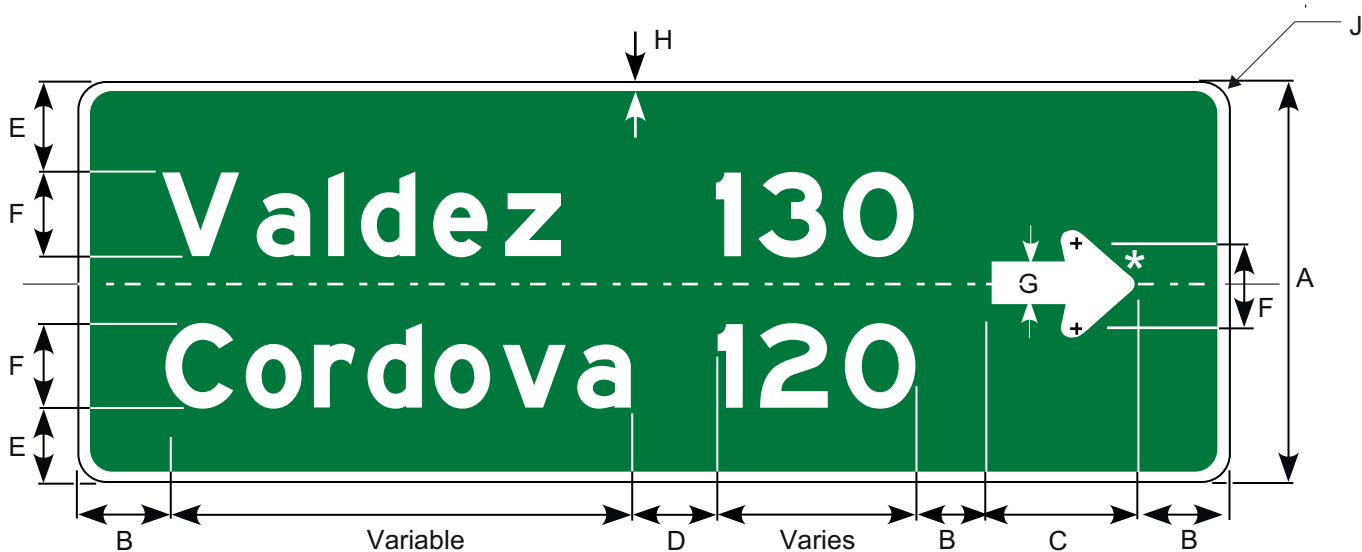

Border and Legend: White
Background: Green

*See Appendix B-1 for Standard Arrow Details.

Prior to the 2002 publication of this manual,
this sign was numbered D1-2A.

Letter Size (inches)	Dimensions (inches)								
	A	B	C	D	E	F	G	H	J
6 / 4.5	24	6.0	9.56	6±	4.0	6.0	2.6	0.75	1.5
8 / 6	36	8.0	12.75	8±	7.0	8.0	3.48	1.0	2.25
10.7 / 8	48	11	17.25	11±	9.0	10.7	4.65	2.0	3.0
13.3 / 10	54	13	20.25	13±	9.5	13.3	5.78	2.0	3.38
16 / 12	66	16	25	16±	12	16	6.96	3.0	4.13

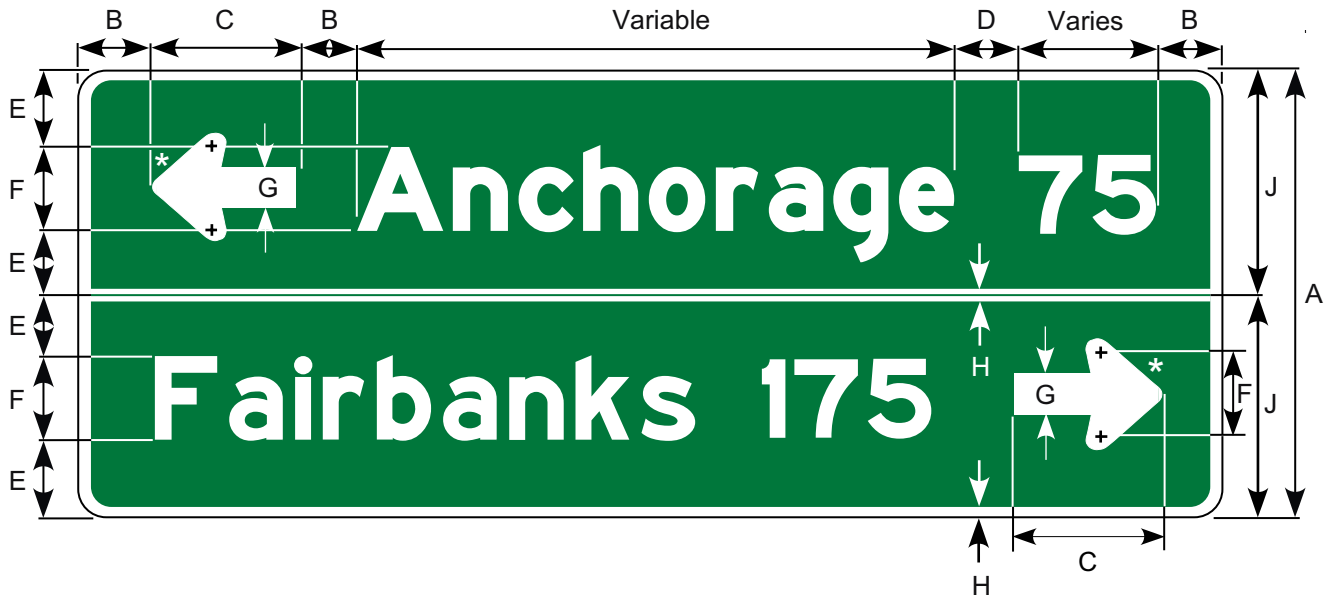

Border and Legend: White
Background: Green

*See Appendix B-1 for Standard Arrow Details.

Prior to the 2002 publication of this manual,
this sign was numbered D1-2A.

Letter Size (inches)	Dimensions (inches)								
	A	B	C	D	E	F	G	H	J
6 / 4.5	24	6.0	9.56	6±	4.0	6.0	2.6	0.75	12
8 / 6	42	8.0	12.75	8±	7.0	8.0	3.48	1.0	21
10.7 / 8	54	11	17.25	11±	9.0	10.7	4.65	2.0	27
13.3 / 10	66	13	20.25	13±	9.5	13.3	5.78	2.0	33
16 / 12	78	16	25	16±	12	16	6.96	3.0	39

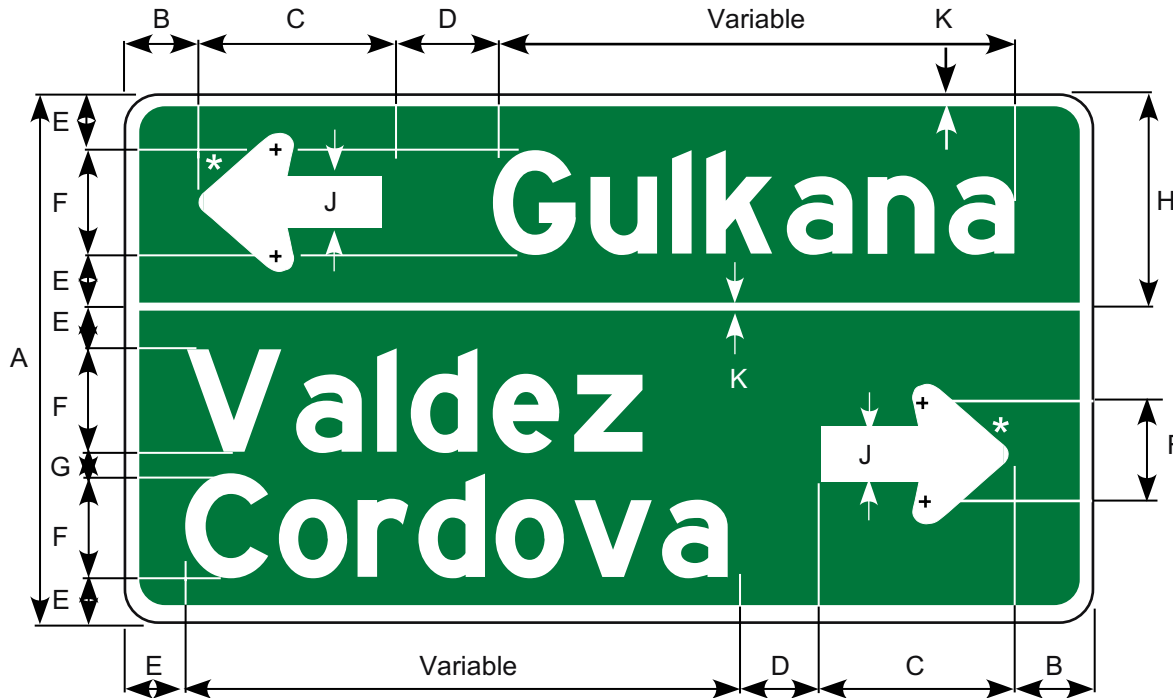

Border and Legend: White
Background: Green

*See Appendix B-1 for Standard Arrow Details.

Prior to the 2002 publication of this manual,
this sign was numbered D1-3.

Letter Size (inches)	Dimensions (inches)									
	A	B	C	D	E	F	G	H	J	K
6 / 4.5	36	6.0	9.56	6±	3.5	6.0	2.0	13.0	2.6	1.0
8 / 6	54	8.0	12.75	8±	6.0	8.0	6.0	20.0	3.48	1.25
10.7 / 8	72	11	17.25	11±	8.0	10.7	8.0	26.7	4.65	2.0
13.3 / 10	90	13	20.25	13±	10	13.3	10	33.3	5.78	3.0
16 / 12	108	16	25	16±	12	16	12	40	6.96	3.0

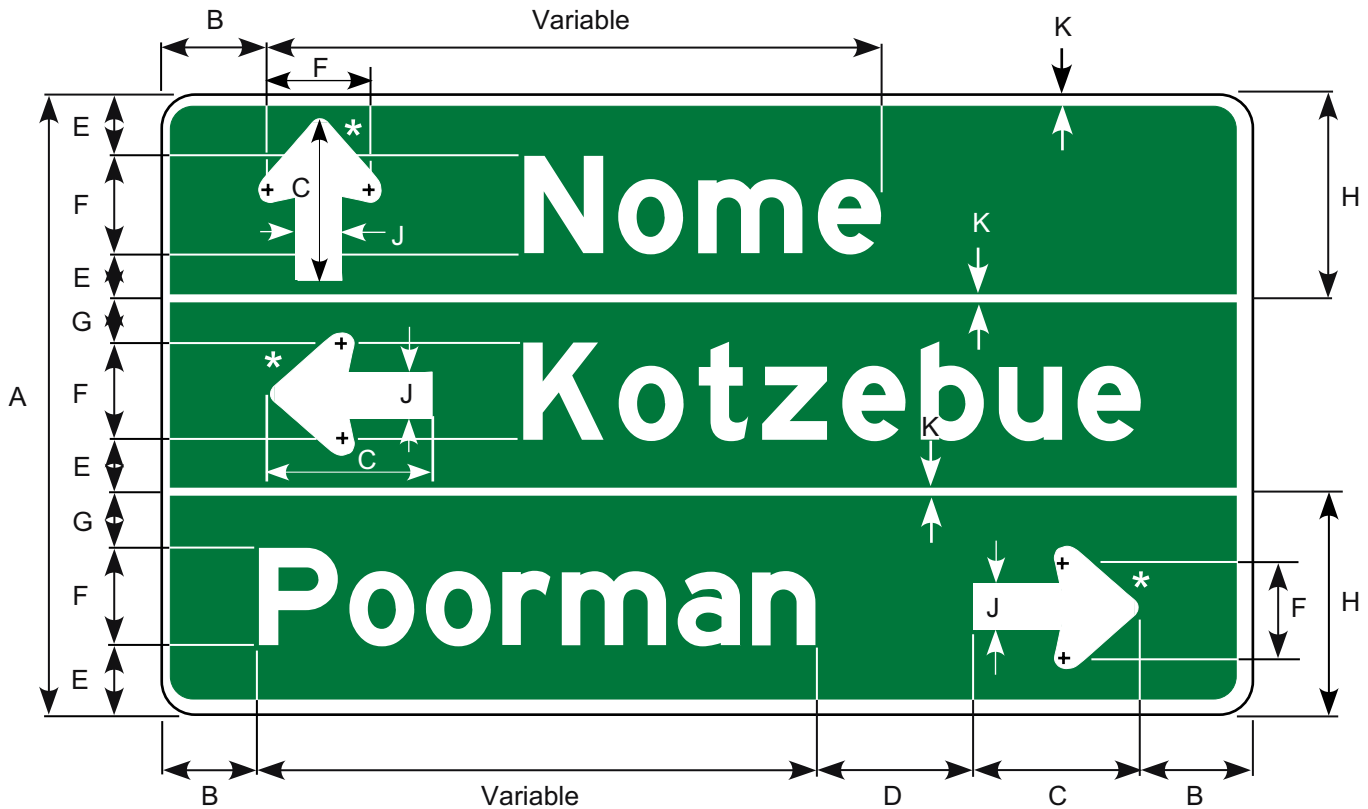

Border and Legend: White
Background: Green

*See Appendix B-1 for Standard Arrow Details.

Prior to the 2002 publication of this manual,
this sign was numbered D1-3.

Letter Size (inches)	Dimensions (inches)									
	A	B	C	D	E	F	G	H	J	K
6 / 4.5	42	6.0	9.56	6±	4.0	6.0	4.0	14	2.6	1.0
8 / 6	48	8.0	12.75	8±	6.0	8.0	6.0	16	3.48	1.25
10.7 / 8	78	11	17.25	11±	8.0	10.7	8.0	26.7	4.65	2.0
13.3 / 10	102	13	20.25	13±	10	13.3	11	33.3	5.78	3.0
16 / 12	120	16	25	16±	12	12	12	40	6.96	3.0

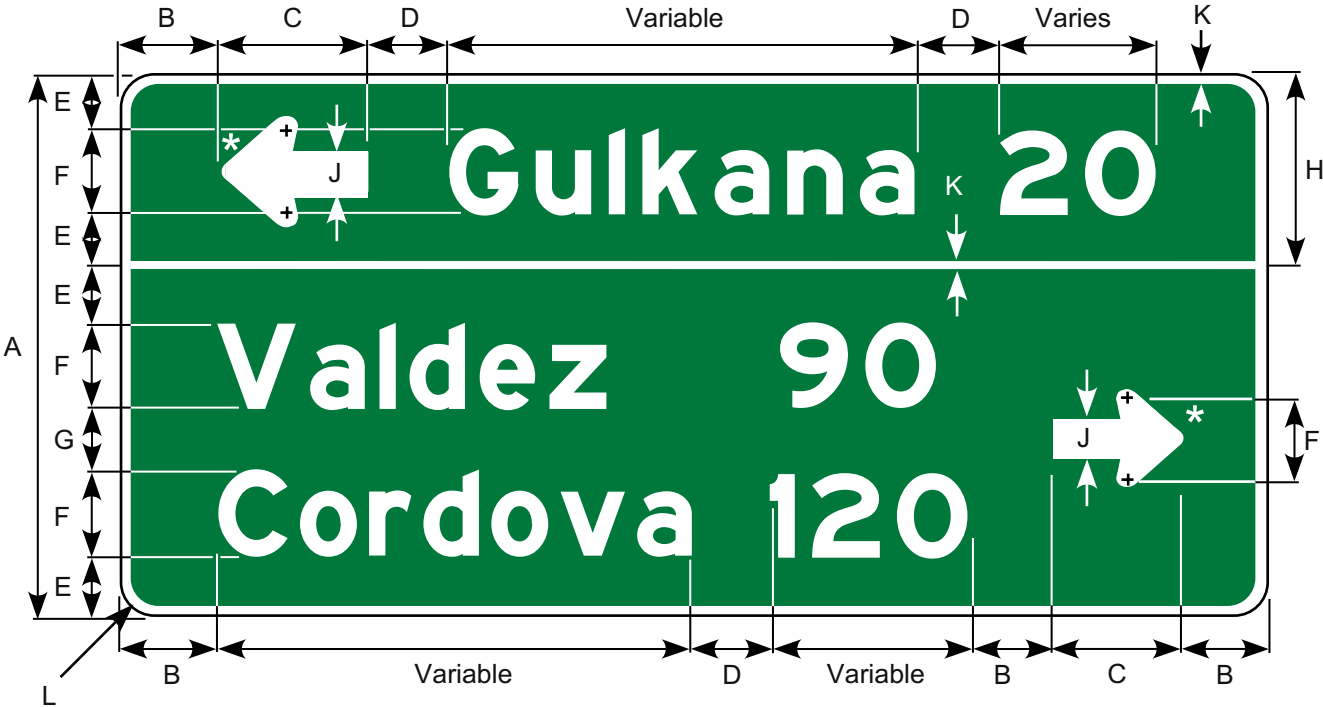

Border and Legend: White
 Background: Green

*See Appendix B-1 for Standard Arrow Details.

Prior to the 2002 publication of this manual,
 this sign was numbered D1-3A.

Letter Size (inches)	Dimensions (inches)									
	A	B	C	D	E	F	G	H	K	L
6 / 4.5	36	6±	9.56	9	3.5	6.0	4.0	13	1.0	2.25
8 / 6	54	8±	12.75	12	6.0	8.0	6.0	20	1.25	3.38
10.7 / 8	72	11±	17.25	16	8.0	10.7	8.0	26.7	2.0	4.0
13.3 / 10	90	13±	20.25	20	10	13.3	10	33.3	3.0	4.0
16 / 12	108	16±	25	24	12	16	12	40	3.0	4.0

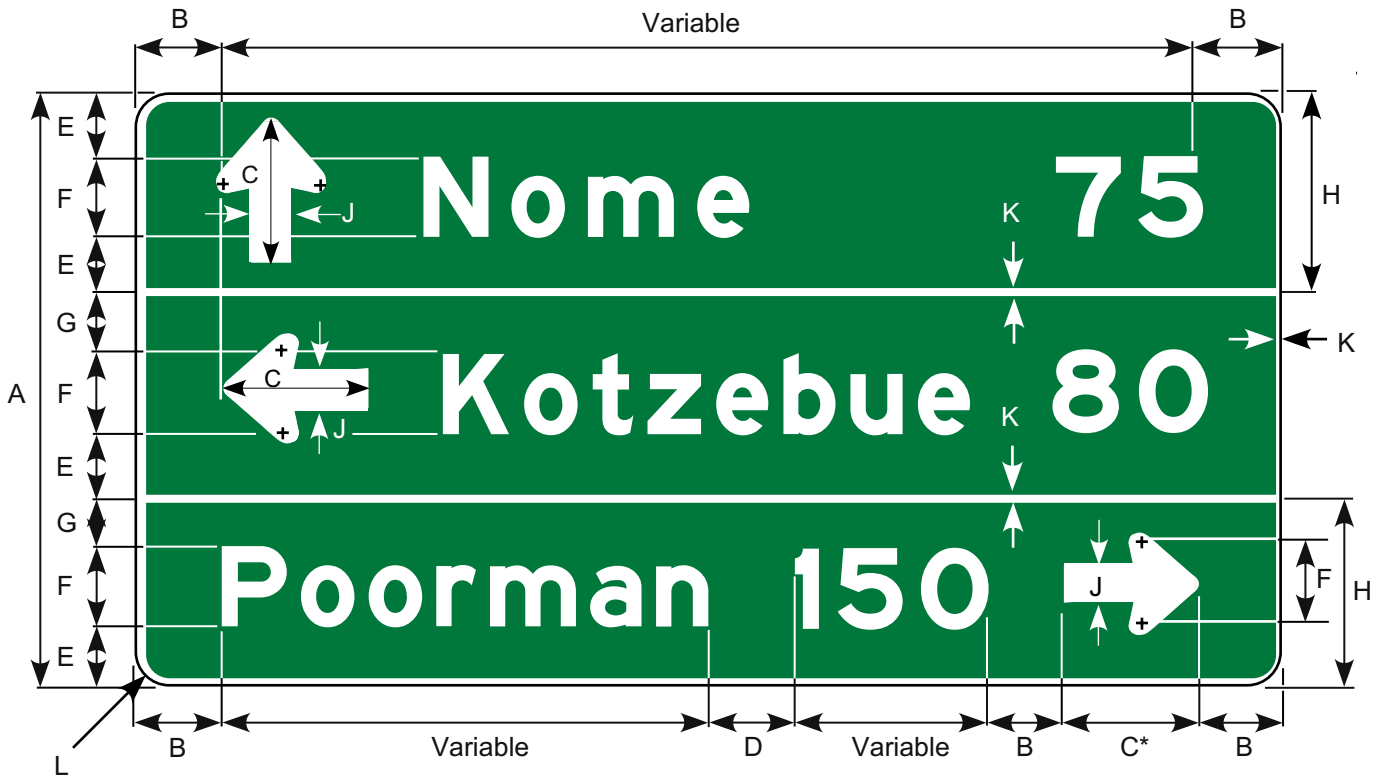

Border and Legend: White
Background: Green

See Appendix B-1 for Standard Arrow Details.

Prior to the 2002 publication of this manual,
this sign was numbered D1-3A.

Letter Size (inches)	Dimensions (inches)										
	A	B	C	D	E	F	G	H	J	K	L
6 / 4.5	42	6±	9.56	9	4.0	6.0	4.0	14	2.6	1.0	2.6
8 / 6	48	8±	12.75	12	6.0	8.0	6.0	16	3.48	1.25	3.0
10.7 / 8	78	11±	17.25	16	8.0	10.7	8.0	26.7	4.65	2.0	4.0
13.3 / 10	102	13±	20.25	20	10	13.3	11	33.3	5.78	3.0	4.0
16 / 12	120	16±	25	24	12	12	12	40	6.96	3.0	4.0

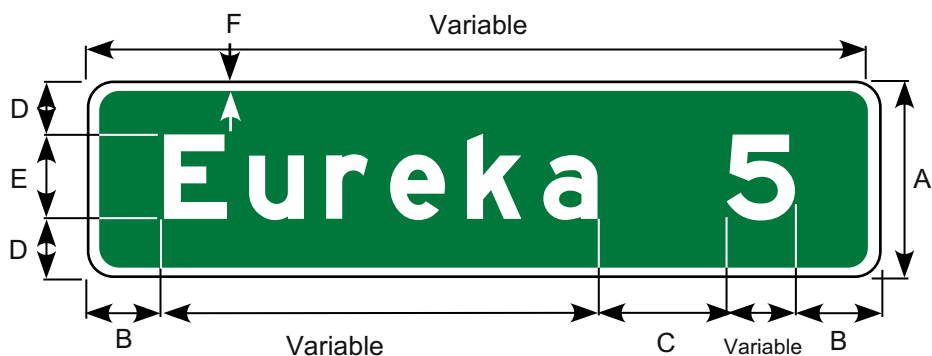

Border and Legend: White
Background: Green

Letter Size (inches)	Dimensions (inches)					
	A	B	C	D	E	F
6 / 4.5	12	4±	9.0	3.0	6.0	0.63
8 / 6	18	6±	12	5.0	8.0	0.75
10.7 / 8	24	8±	16	6.65	10.7	1.25
13.3 / 10	30	10±	20	8.35	13.3	2.0
16 / 12	36	12±	24	10	16.0	2.0

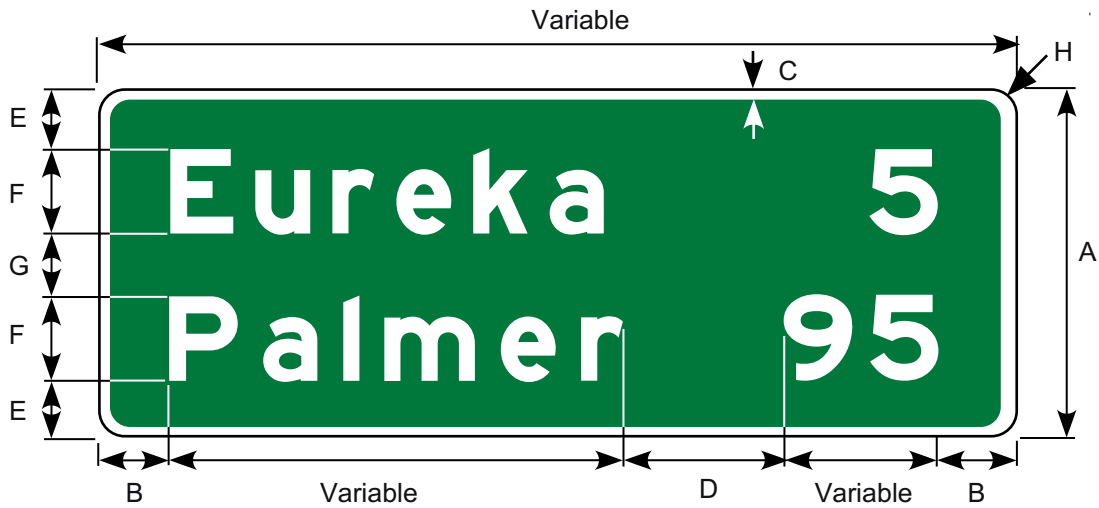

Border and Legend: White
Background: Green

Letter Size (inches)	Dimensions (inches)							
	A	B	C	D	E	F	G	H
6 / 4.5	24	6±	0.63	9.0	4.0	6.0	4.0	1.5
8 / 6	36	8±	0.75	12	7.0	8.0	6.0	2.25
10.7 / 8	48	11±	1.25	16	9.0	10.7	8.6	3.0
13.3 / 10	54	13±	2.0	20	9.5	13.3	8.4	3.38
16 / 12	66	16±	2.0	24	12	16	10	4.0

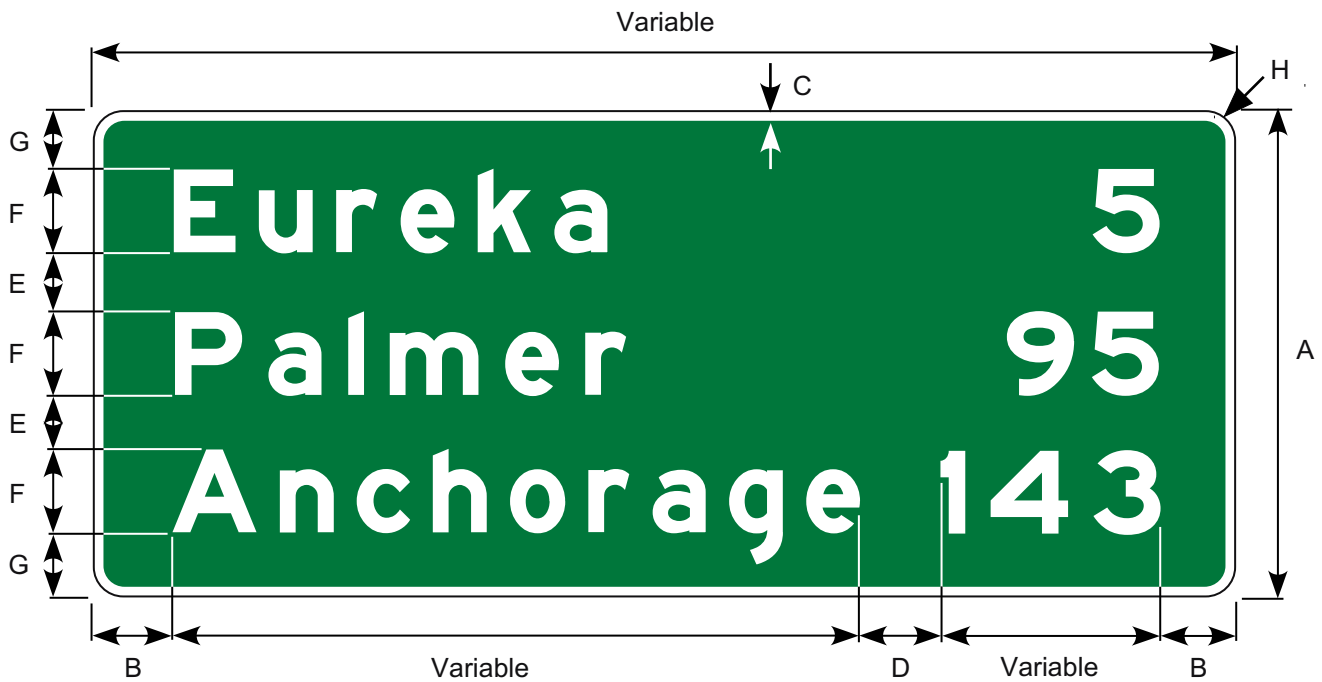

Border and Legend: White
Background: Green

Letter Size (inches)	Dimensions (inches)							
	A	B	C	D	E	F	G	H
6 / 4.5	36	6±	1.0	9.0	4.0	6.0	5.0	2.25
8 / 6	48	8±	1.25	12	5.0	8.0	7.0	3.0
10.7 / 8	66	11±	2.0	16	7.0	10.7	10	4.0
13.3 / 10	78	13±	2.0	20	9.0	13.3	10	4.0
16 / 12	96	16±	3.0	24	11	16.0	13	4.0

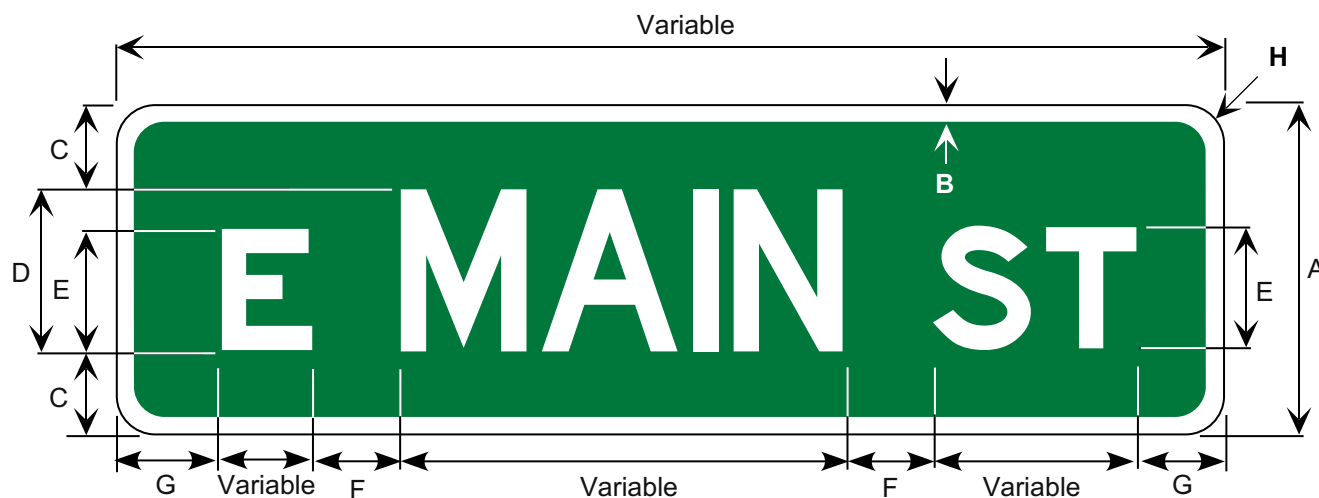

Border and Legend: White
Background: Green

* Letters may be series B, C, or D.

Road Class	Dimensions (inches)							
	A	B	C	D	E	F	G	H
Local Rds w Spd Limits <= 25MPH or STOP Condition	8	0.50	2.0	4*	3*	3.5	3±	1.5
All Other Roads	12	0.50	3.0	6*	4*	5.0	4±	1.5

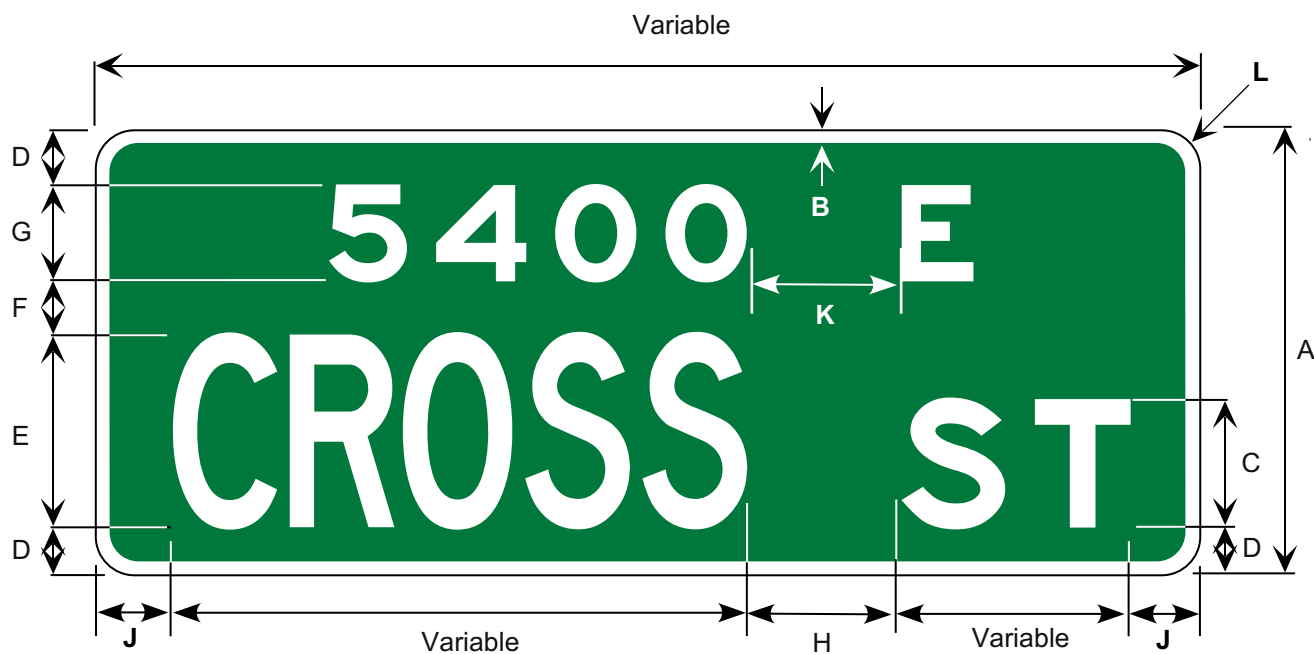

Border and Legend: White
Background: Green

* Letters may be series B, C, or D.

Letter Size (Inches)	Dimensions										
	A	B	C	D	E	F	G	H	J	K	L
6/4	14	0.5	4*	1.5	6*	2.0	3.0	5.0	3±	4.5	1.5

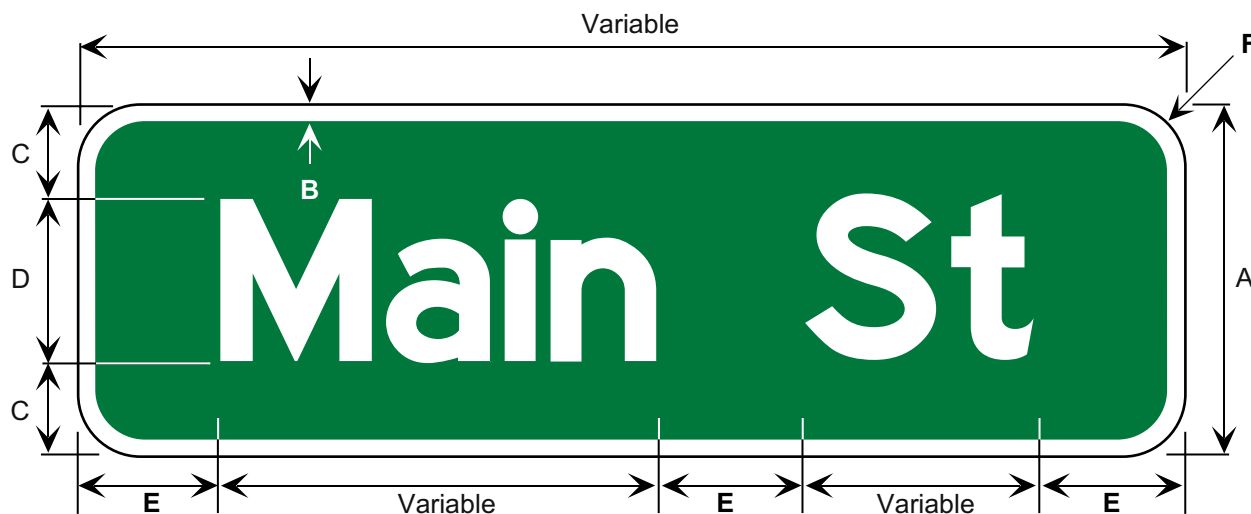

Border and Legend: White
Background: Green

For Overhead Mounting Only

Letter Size (inches)	Dimensions (inches)					
	A	B	C	D	E	F
8 / 6	18	0.50	5.0	8.0	8±	2.25
10.7 / 8	30	0.75	9.65	10.7	11±	3.75
13.3 / 10	36	1.5	11.3	13.3	13±	4.5

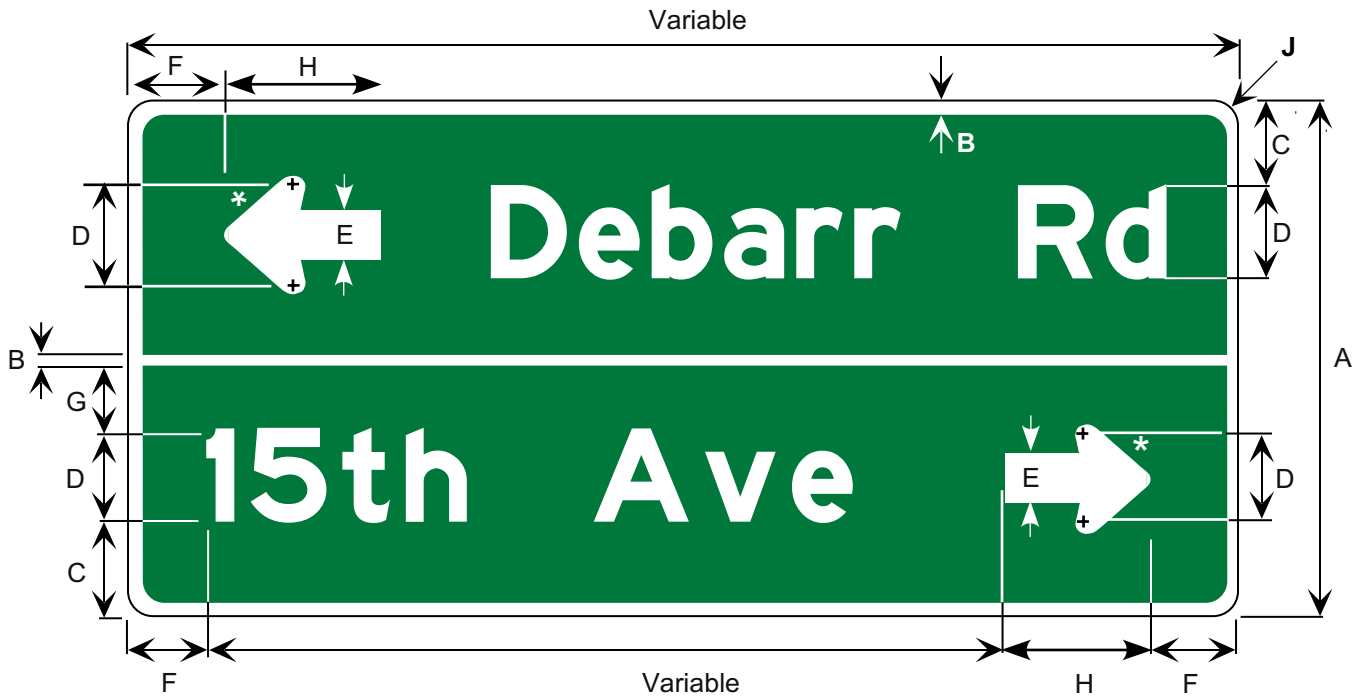

Border and Legend: White
Background: Green

*See Appendix B-1 for Arrow Details.

Letter Size (inches)	Dimensions (inches)								
	A	B	C	D	E	F	G	H	J
6 / 4.5	24	0.75	3.0	6.0	2.6	6±	2.63	9.56	1.5
8 / 6	42	1.0	6.25	8.0	3.48	8±	6.25	12.75	2.5
10.7 / 8	54	1.25	8.15	10.7	4.65	11±	7.5	17.25	3.5
13.3 / 10	66	1.5	9.85	13.3	5.78	13±	9.1	20.25	4.0

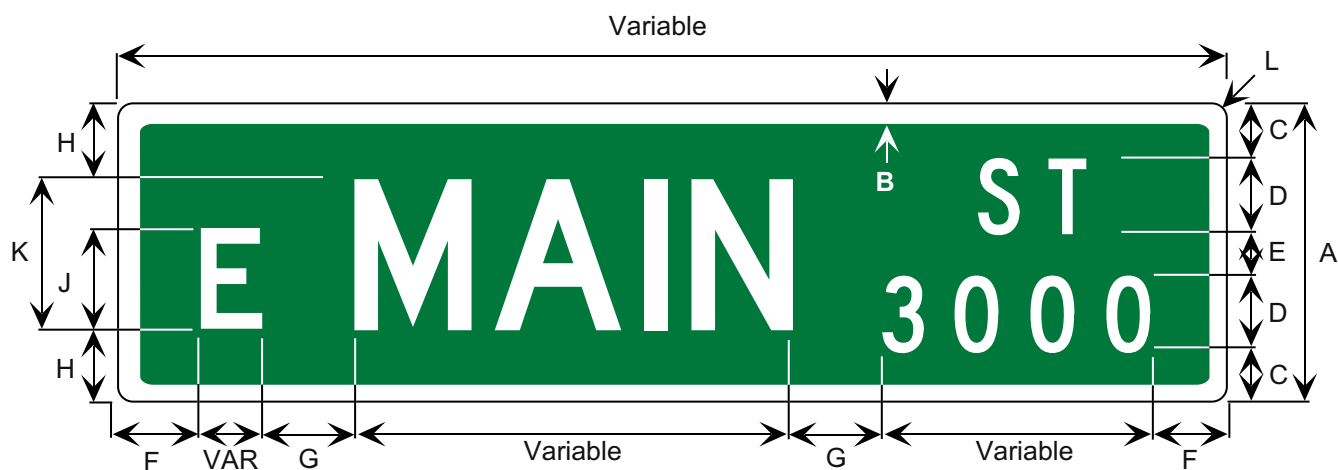

Border and Legend: White
Background: Green

* Letters may be series B, C, or D.

Road Class	Dimensions (inches)										
	A	B	C	D	E	F	G	H	J	K	L
Local Rds w Spd Limits <= 25MPH or Stop Condition	8	0.50	1.5	2*	1.0	3±	3.5	2.0	3*	4*	1.5
All Other Roads	12	0.50	2.0	3*	2.0	4.5±	5.0	3.0	4*	6*	1.5

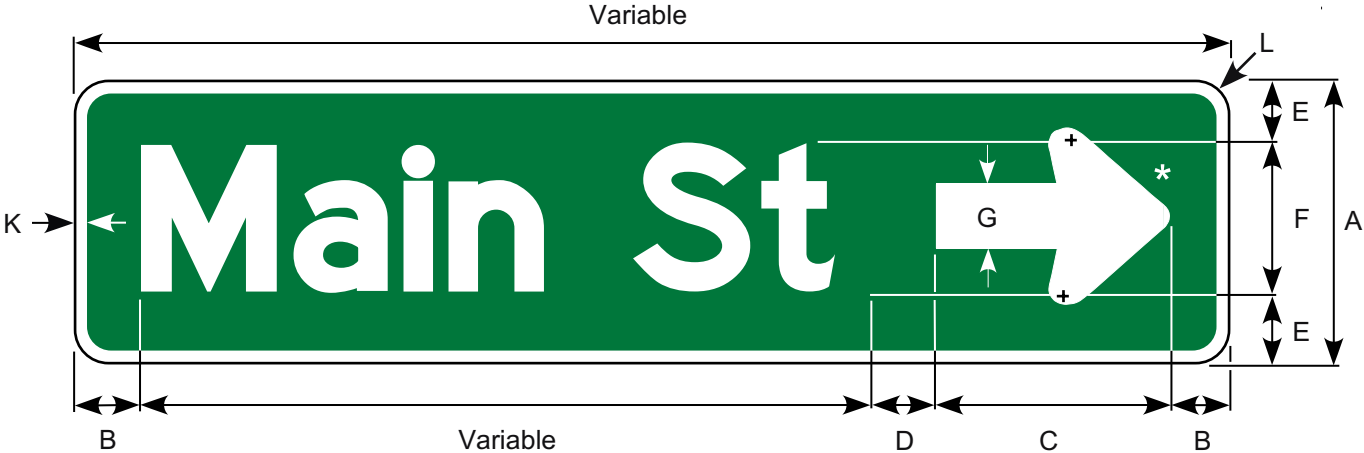

D3-2R

Border and Legend: White
Background: Green

*See Appendix B-1 for Standard Arrow Details.
*Arrow may be omitted



D3-2L

Letter Size (inches)	Dimensions (inches)								
	A	B	C	D	E	F	G	K	L
6 / 4.5	12	6±	9.56	6±	3.0	6.0	2.6	0.63	1.5
8 / 6	24	8±	12.75	8±	8.0	8.0	3.48	0.75	1.5
10.7 / 8	24	11±	17.25	11±	6.65	10.7	4.65	1.25	1.88
13.3 / 10	36	13±	20.25	13±	11.35	13.3	5.78	2.0	2.25
16 / 12	36	16±	25	16±	10	16	6.96	2.0	2.63

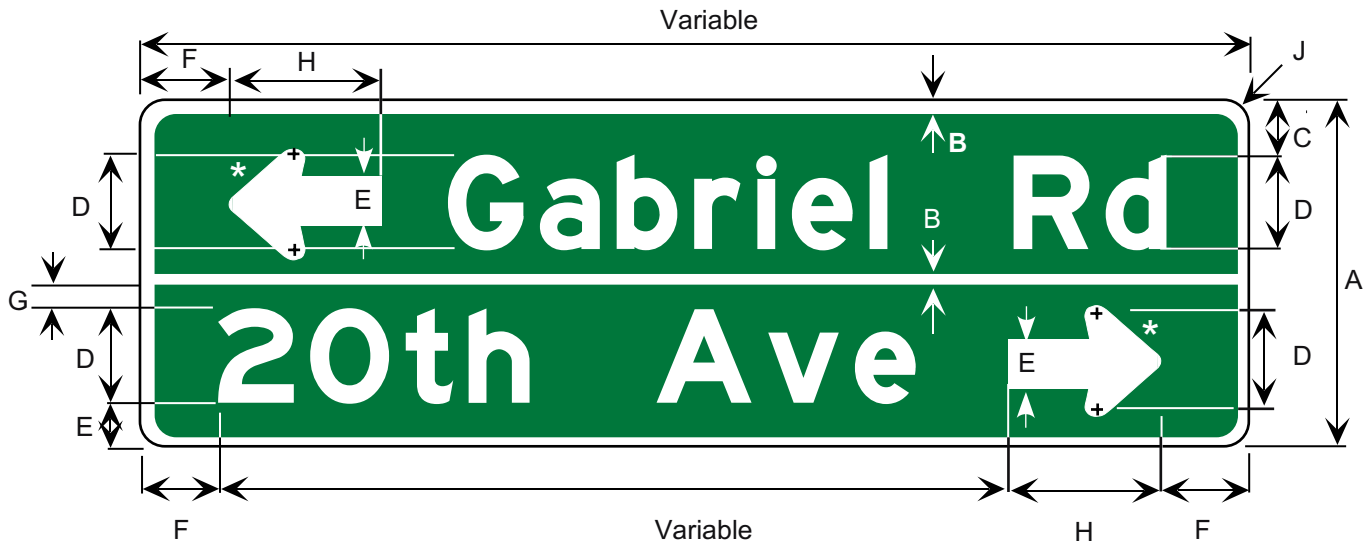

Border and Legend: White
 Background: Green

For Overhead Mounting Only

* See Appendix B-1 for Standard Arrow Details.

Letter Size (inches)	Dimensions (inches)									
	A	B	C	D	E	F	G	H	J	
8 / 6	30	1.0	3.5	8E	4.0	8±	2.5	12.75	2.5	

D3-2C
D3-2D

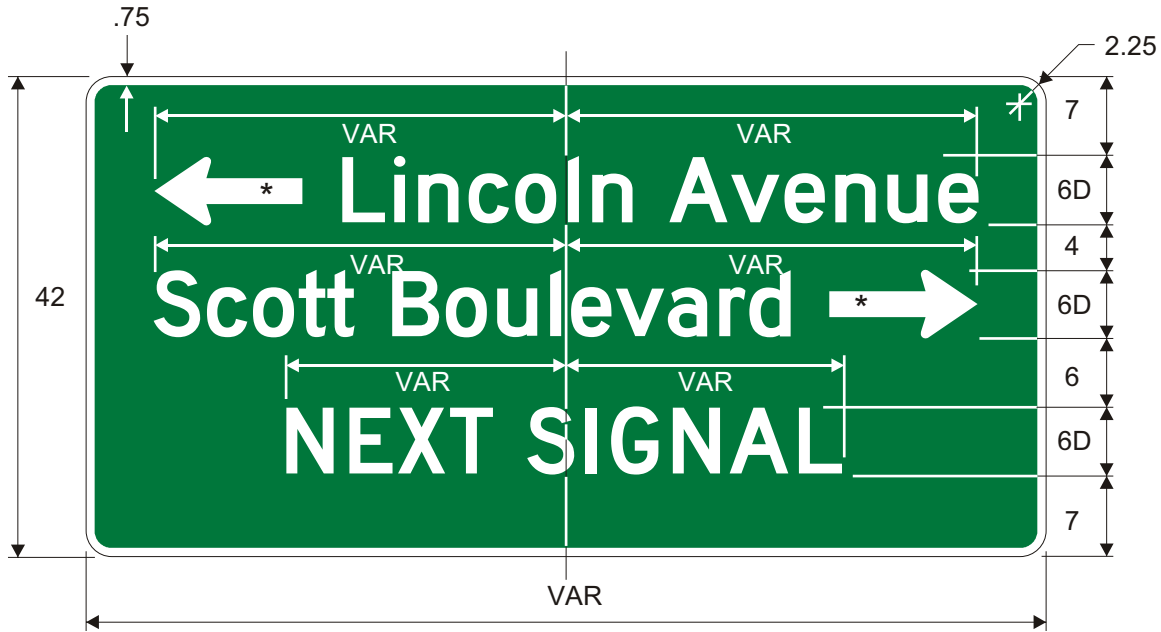

D3-2C

*See Appendix B-1 for Standard Arrow Details.

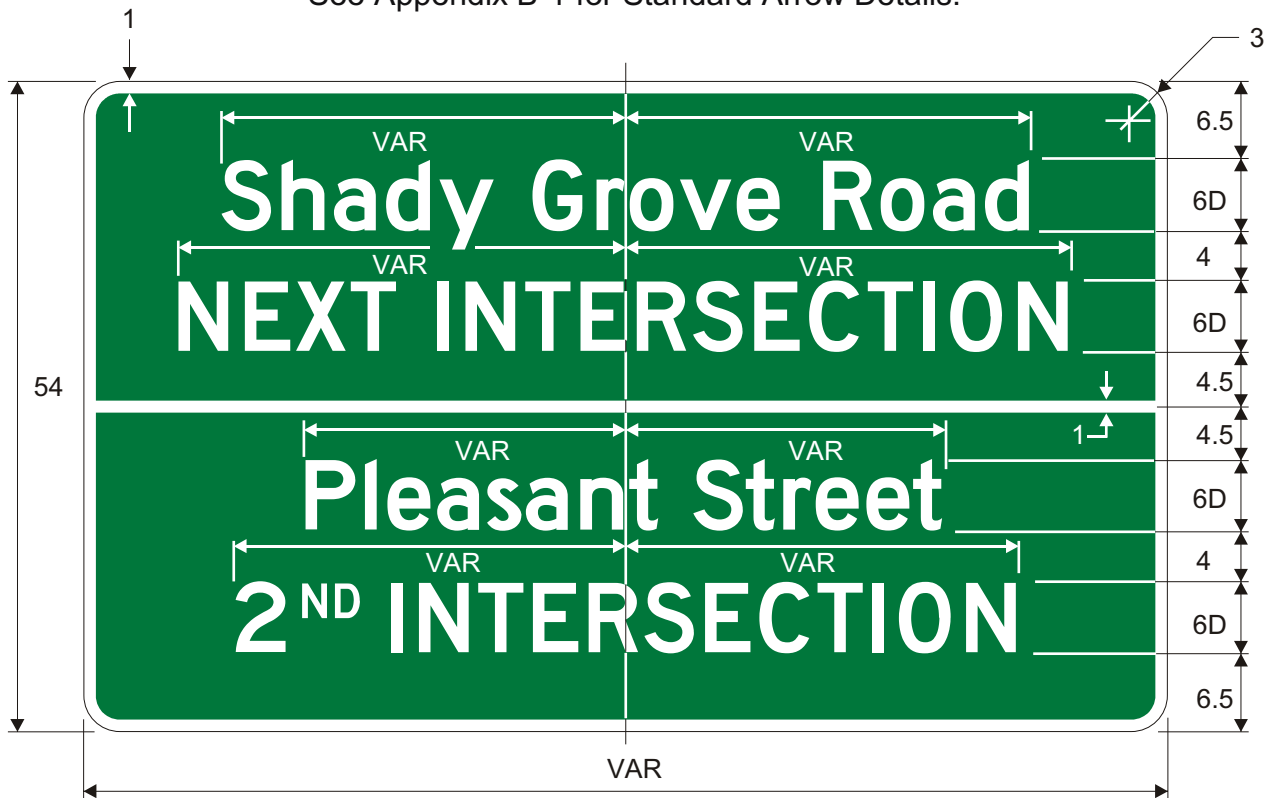

D3-2D

Border and Legend: White
Background: Green

DESTINATION SIGNS - PARKING AREA

D4-1 to D4-100



*See Appendix B-1 for standard arrow details.

Border and Legend: Green
Background: White

*Rotate arrow 45 degrees

Road Class	Dimensions (inches)											
	A	B	C	D	E	F	G	H	J	K	L	M
Conv & Min	30	24	0.38	0.63	15E	4.5	3E	10.13	2.5	9	1.5	7.25

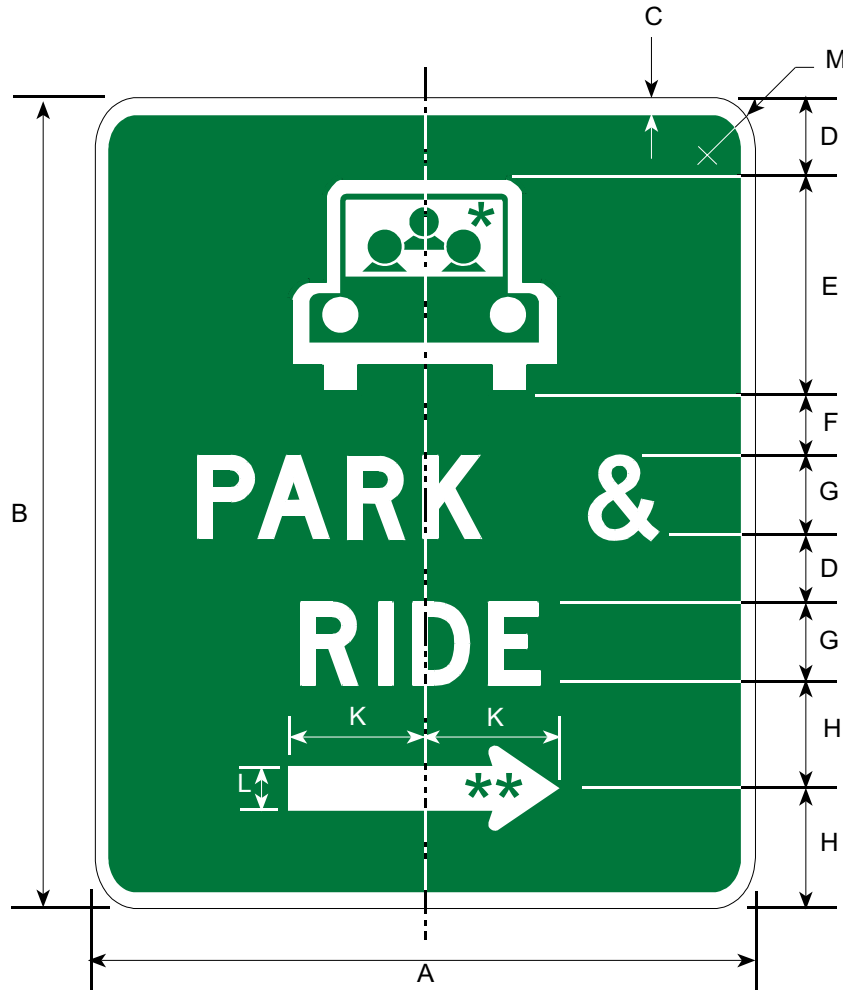

* Make symbol proportional to graphic shown.

Border and Legend: White
Background: Green

Center car symbol if no transit symbol is used.

** See Appendix B-1 for standard arrow details.

Road Class	Dimensions (inches)										
	A	B	C	D	E	F	G	H	K	L	M
Minimum	24	30	0.63	2.0	8.0	3.0	3D	4.5	6.0	1.13	1.5
Conventional	30	36	0.75	3.0	9.0	3.0	4D	5.0	7.0	1.50	1.88
Expressway	36	48	0.88	4.0	11	3.0	6D	7.0	9.0	2.25	2.25

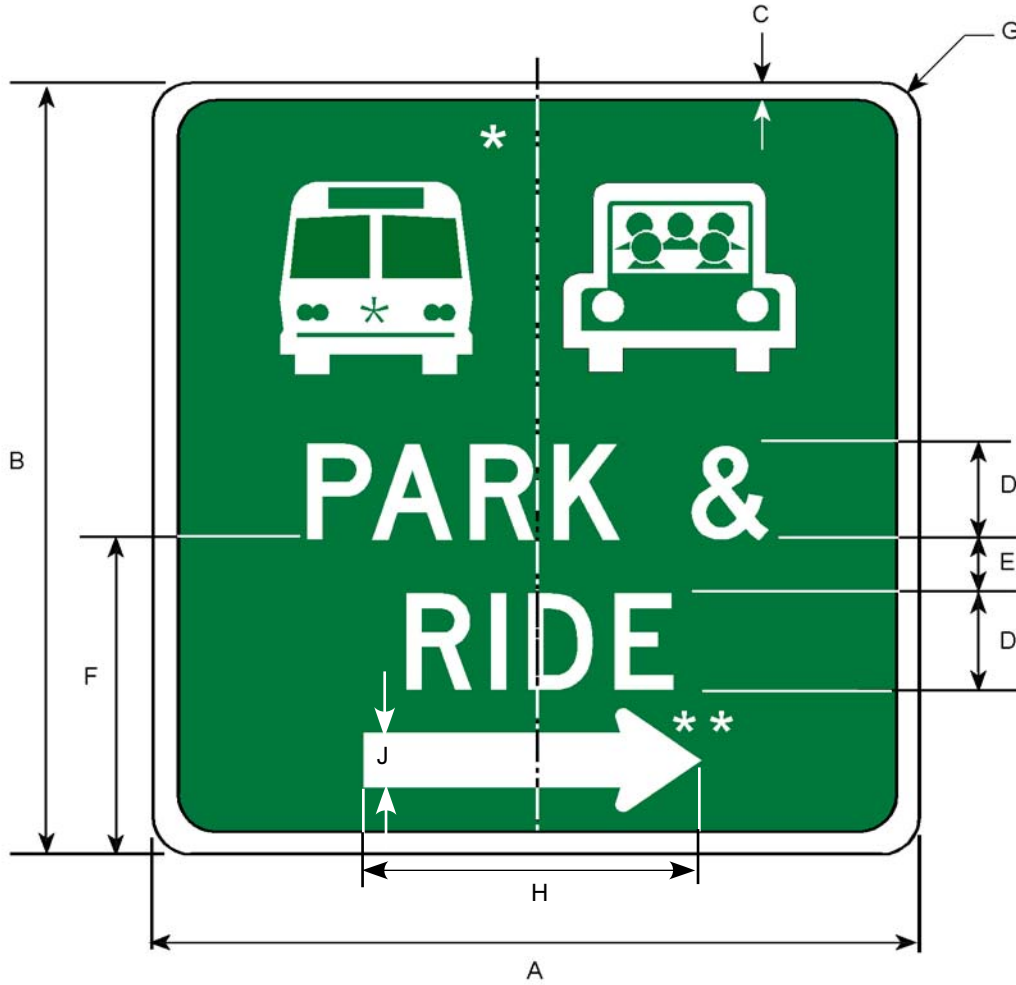

*Make symbol proportional to graphic shown.

Border and Legend: White
Background: Green

**See Appendix B-1 for standard arrow details.

Road Class	Dimensions (inches)									
	A	B	C	D	E	F	G	H	J	
Conv & Min	24	24	0.63	3D	2	12	1.5	12	1.13	

DESTINATION SIGNS - REST AREA

D5-1 to D5-104

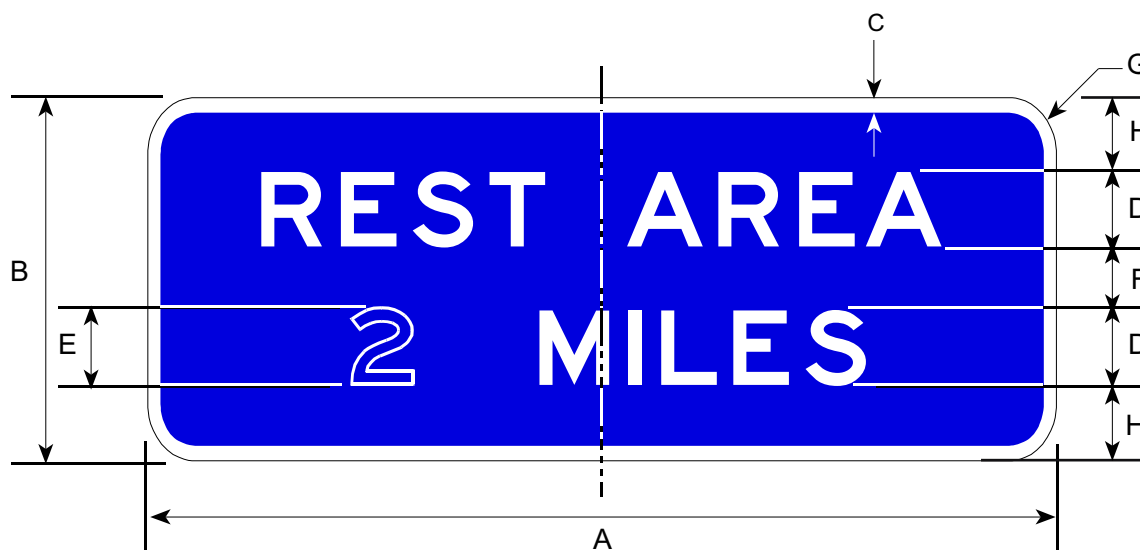

Border and Legend: White
 Background: Blue

Road Class	Dimensions (inches)							
	A	B	C	D	E	F	G	H
Minimum	96	36	1.5	8E	10	5.5	4	7.25
Conventional	120	48	2.0	10E	12	8.0	6	10.00
Expressway	144	60	2.0	12E	15	10.5	6	12.75

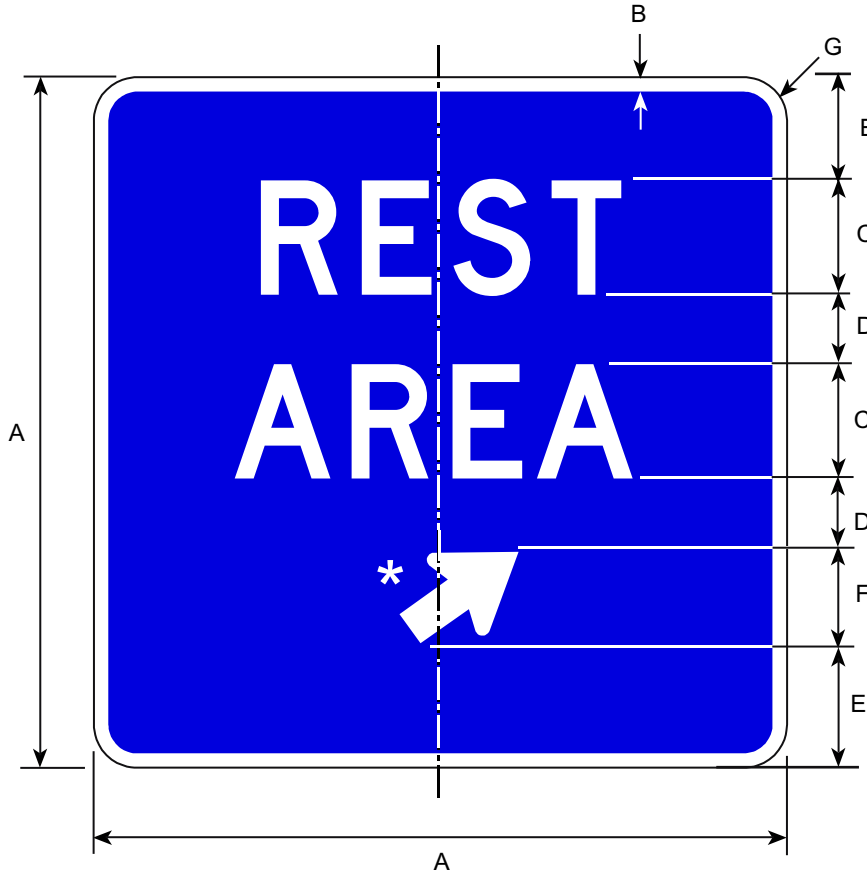

*See Appendix B-4 for Arrow Details.
*Tilt Arrow 30°.

Border and Legend: White
Background: Blue

Prior to the 2002 publication of this manual, this sign was numbered I-21.

Road Class	Dimensions (inches)						
	A	B	C	D	E	F	G
Minimum	48	1.5	8D	4	6.56	9.88 (Arw No. 1)	4
Conventional	60	2.0	10D	5	6.81	16 (Arw No. 3)	6
Expressway	72	2.0	12D	6	7.88	17.75 (Arw No. 5)	6

D5-3
D5-3C

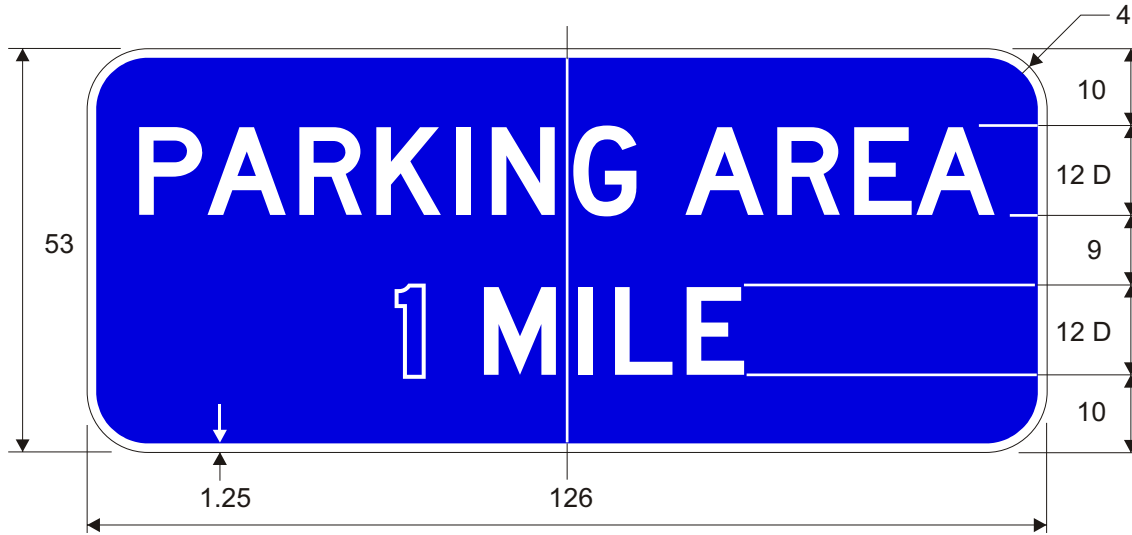

D5-3

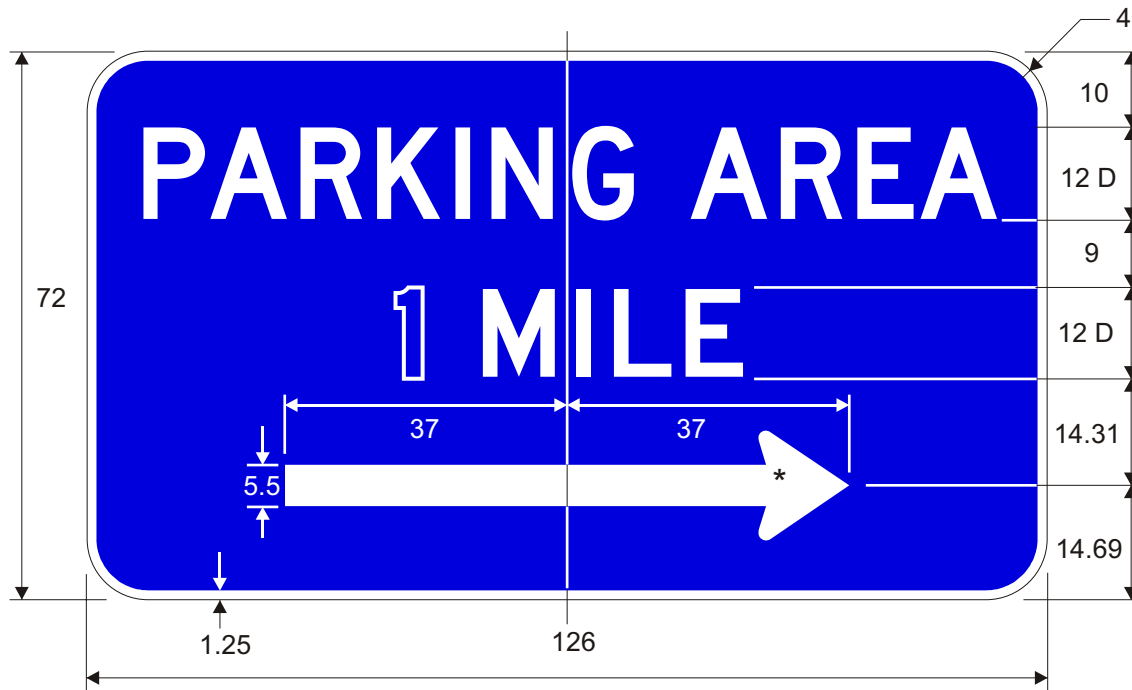

D5-3C

* See Appendix B-1 for standard arrow details.

Border and Legend: White
Background: Blue

D5-4

D5-5

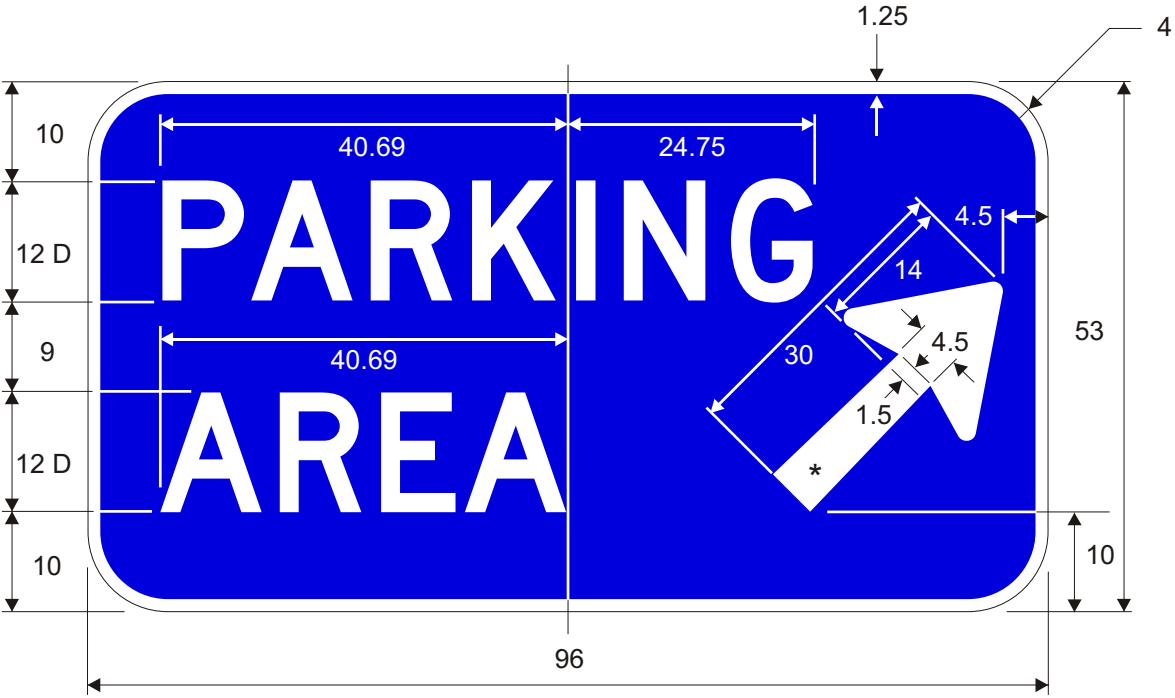

D5-4

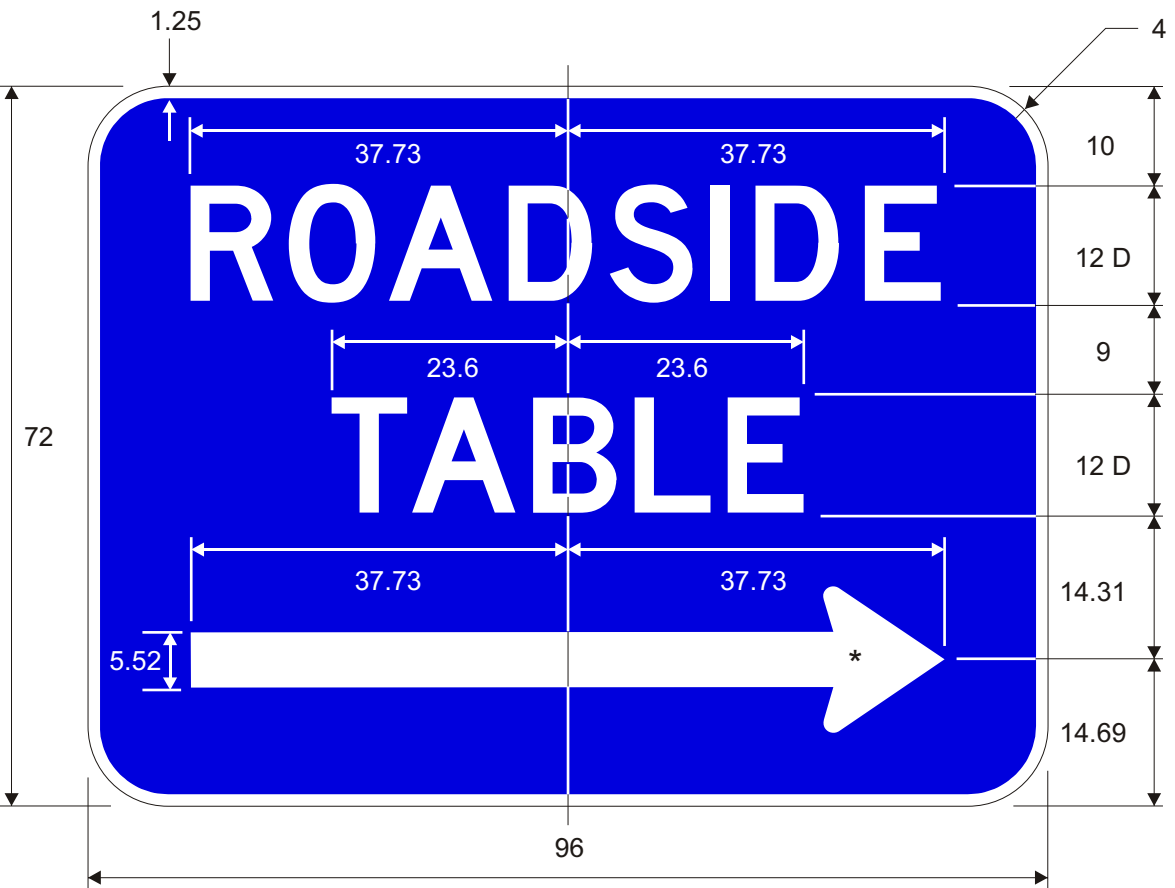

D5-5

Border and Legend: White
Background: Blue

* See Appendix B-1 for Standard Arrow Details.

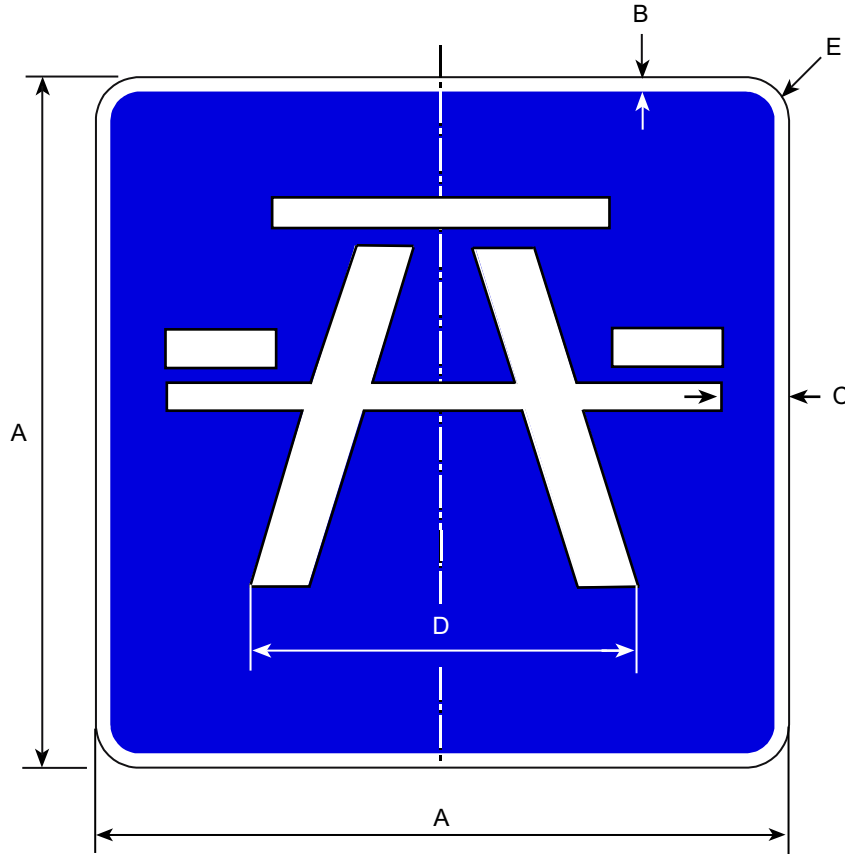

Border and Legend: White
Background: Blue

Road Class	Dimensions (inches)				
	A	B	C	D	E
Minimum	18	0.50	1.5	15	1.5
Conventional	24	0.50	2.0	20	1.5
Expressway	30	0.75	2.5	25	1.88

D5-5B
D5-5C

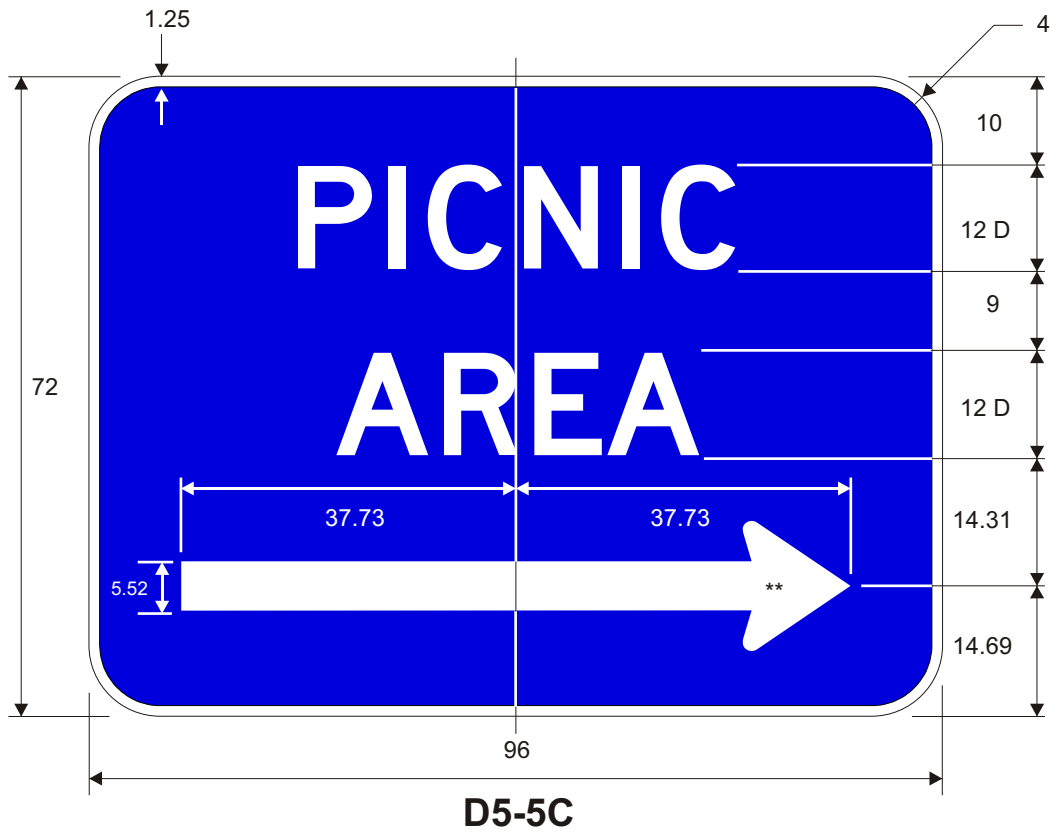

Border and Legend: White
Background: Blue

* See Appendix B-1 for Standard Arrow Details.

D5-5D

D5-5E

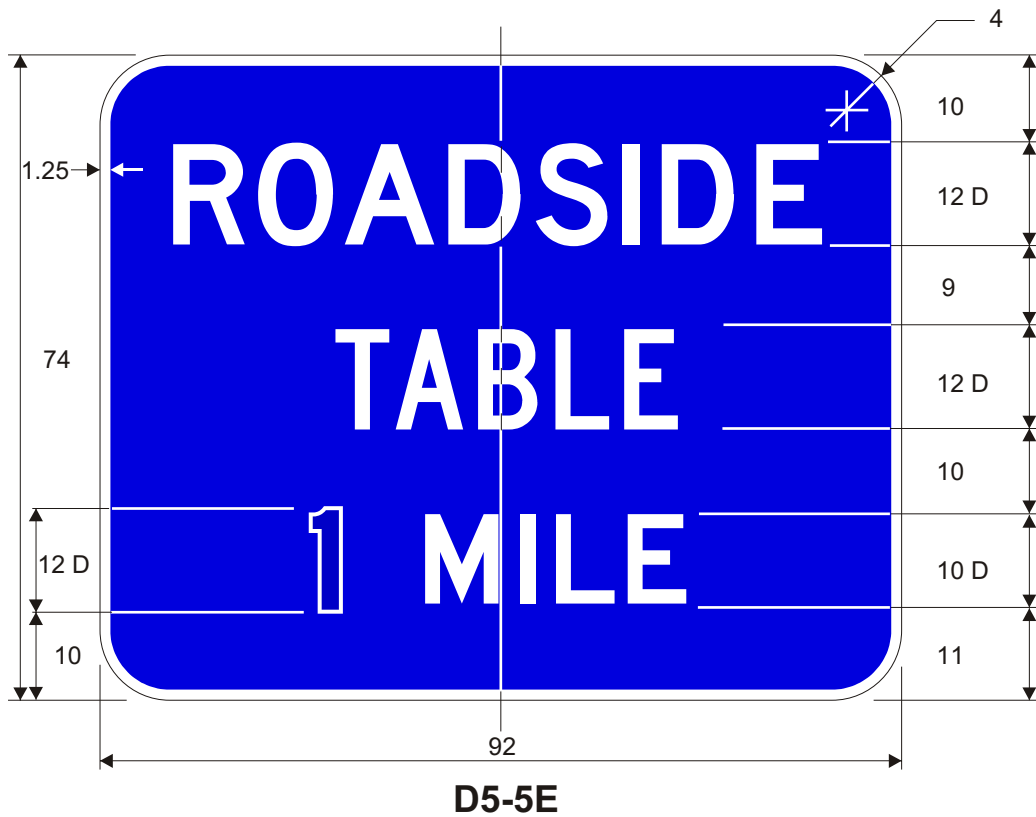

Border and Legend: White
Background: Blue



Border and Legend: White
Background: Blue

D5-7
D5-7A



*Optically Center

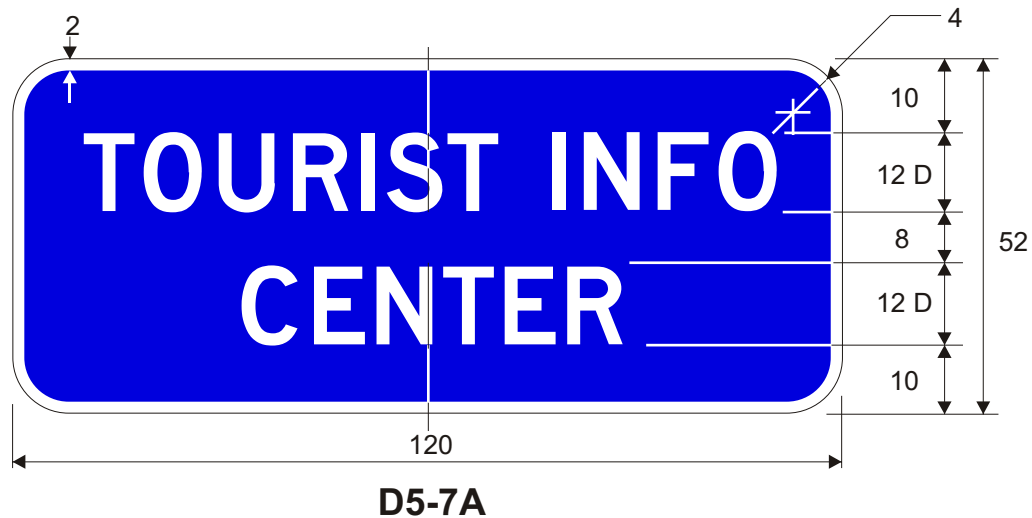

Border and Legend: White
Background: Blue

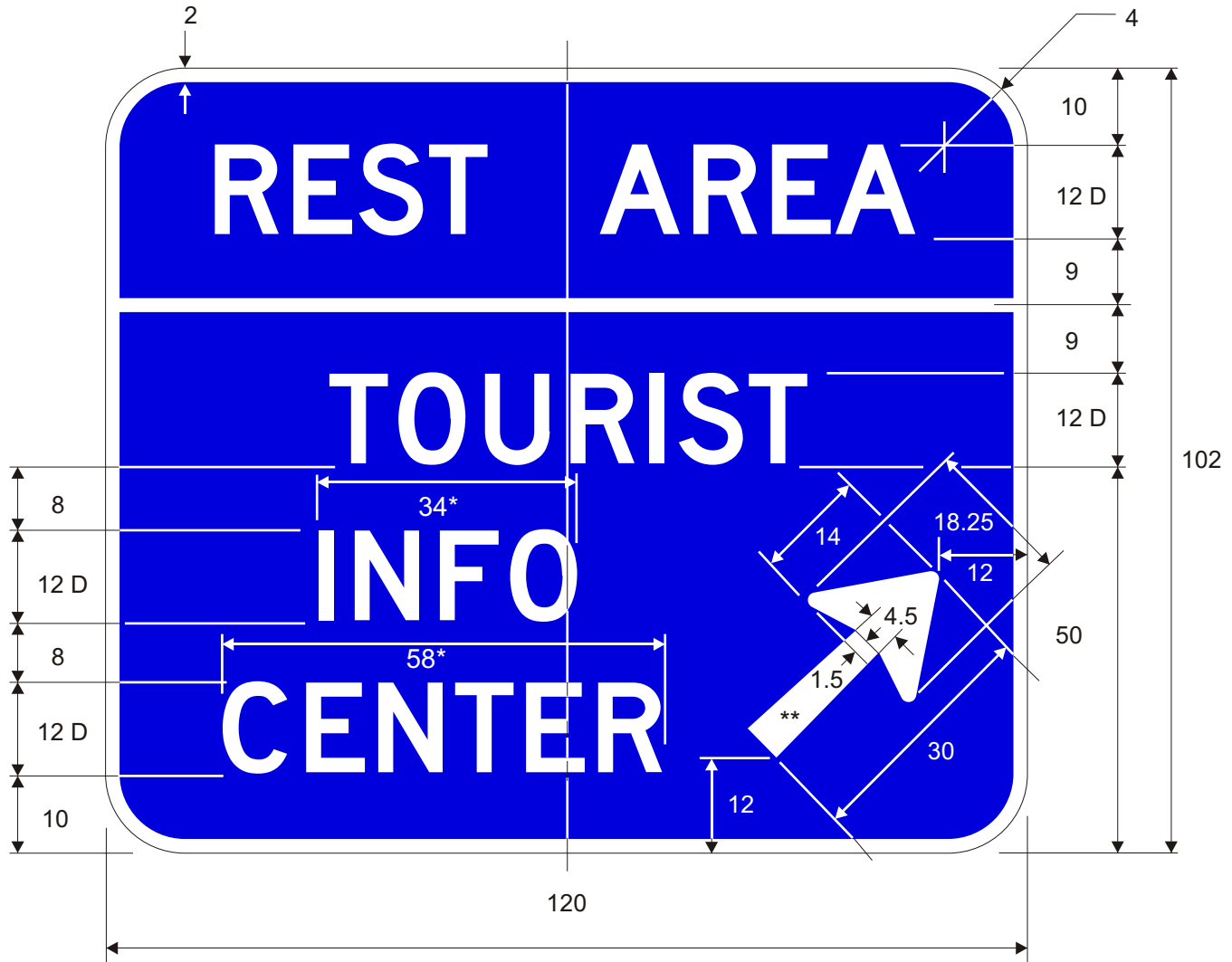

- * Optically center legend
- ** See Appendix B-2 for Arrow Details.

Border and Legend: White
 Background: Blue

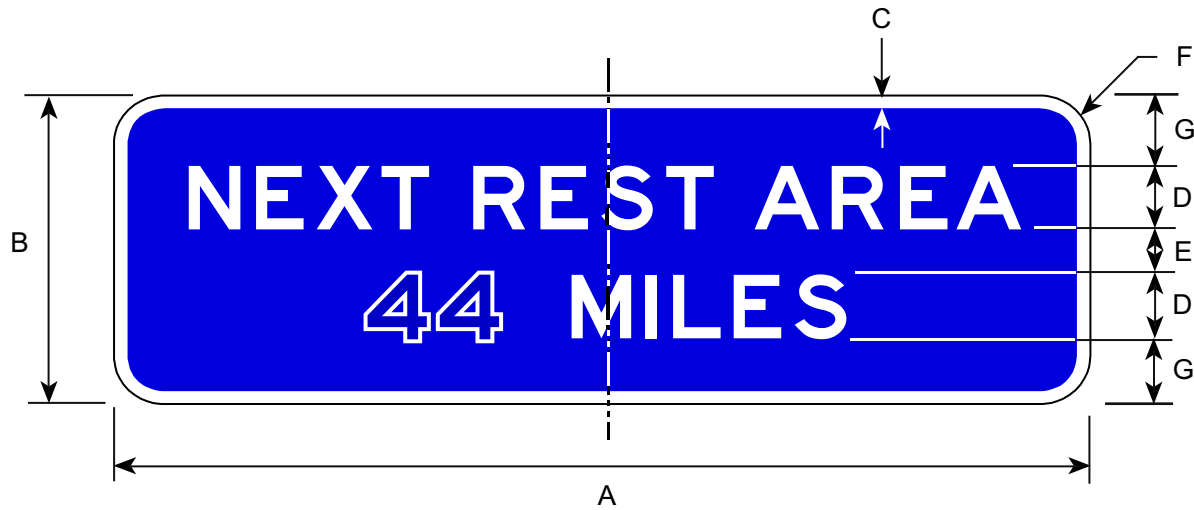

Border and Legend: White
Background: Blue

Road Class	Dimensions (inches)						
	A	B	C	D	E	F	G
Minimum	84	24	0.75	6E	3.5	1.50	4.25
Conventional	108	36	1.50	8E	5.5	2.25	7.25

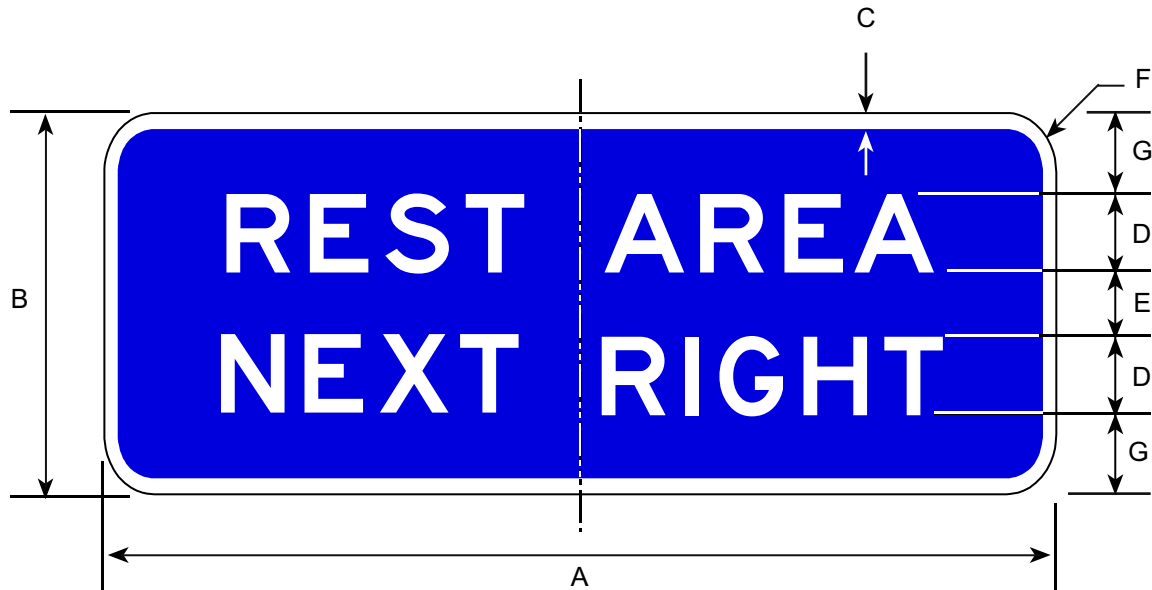

Border and Legend: White
Background: Blue

Road Class	Dimensions (inches)						
	A	B	C	D	E	F	G
Conventional	96	36	1.5	8E	5.50	2.25	7.25
Expressway	120	48	2.0	10E	8.00	3.00	10.00
Freeway	144	60	2.0	12E	10.5	3.75	12.75

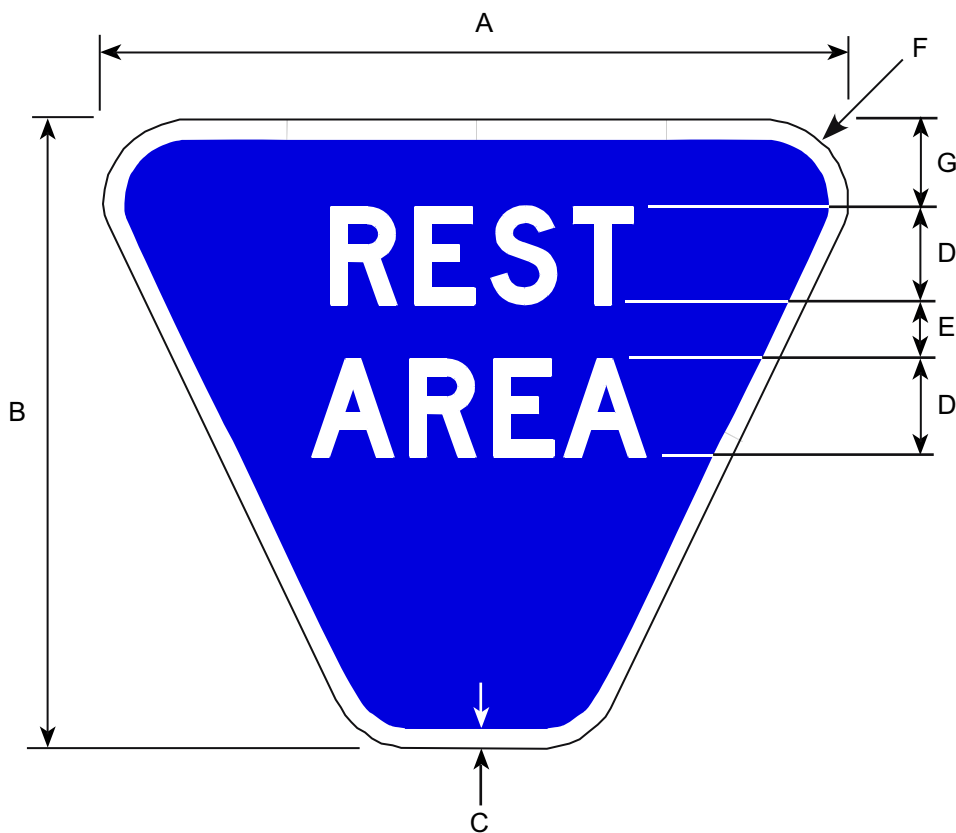

Border and Legend: White
Background: Blue

Road Class	Dimensions (inches)						
	A	B	C	D	E	F	G
Minimum	36	30	0.63	4D	3	3	4
Conventional	48	40	1.00	6D	5	4	6

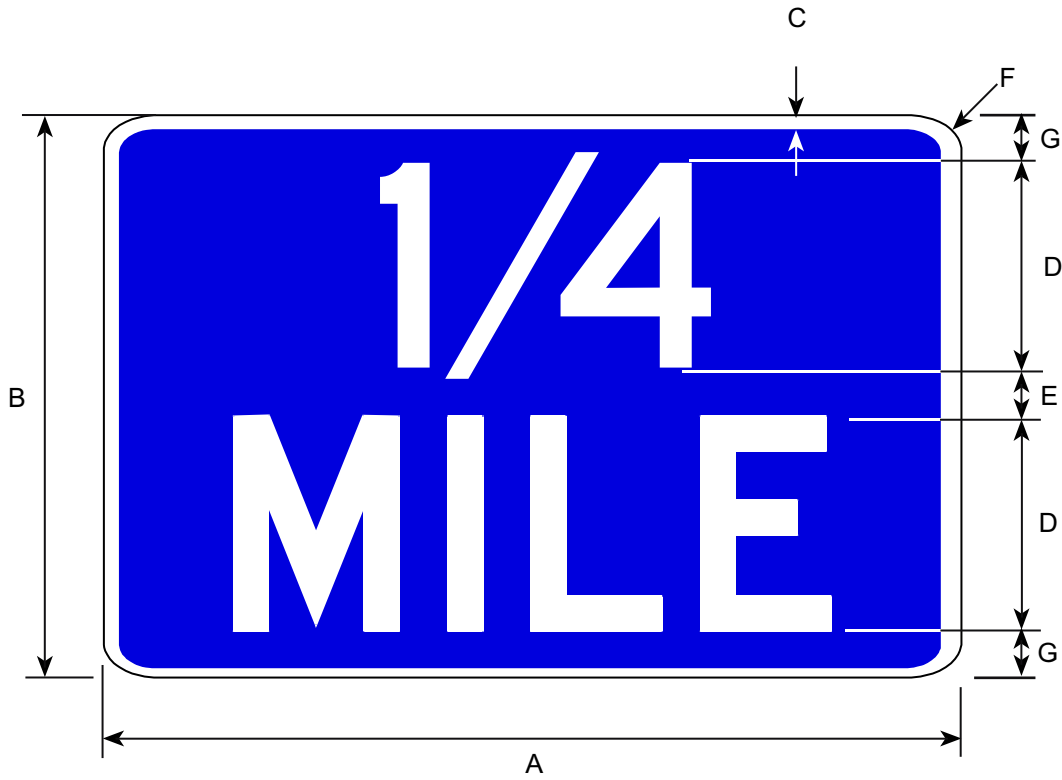

Border and Legend: White
Background: Blue

Road Class	Dimensions (inches)						
	A	B	C	D	E	F	G
Minimum	18	12	0.38	4D	1.0	1.5	1.50
Conventional	24	18	0.50	6D	1.5	1.5	2.25

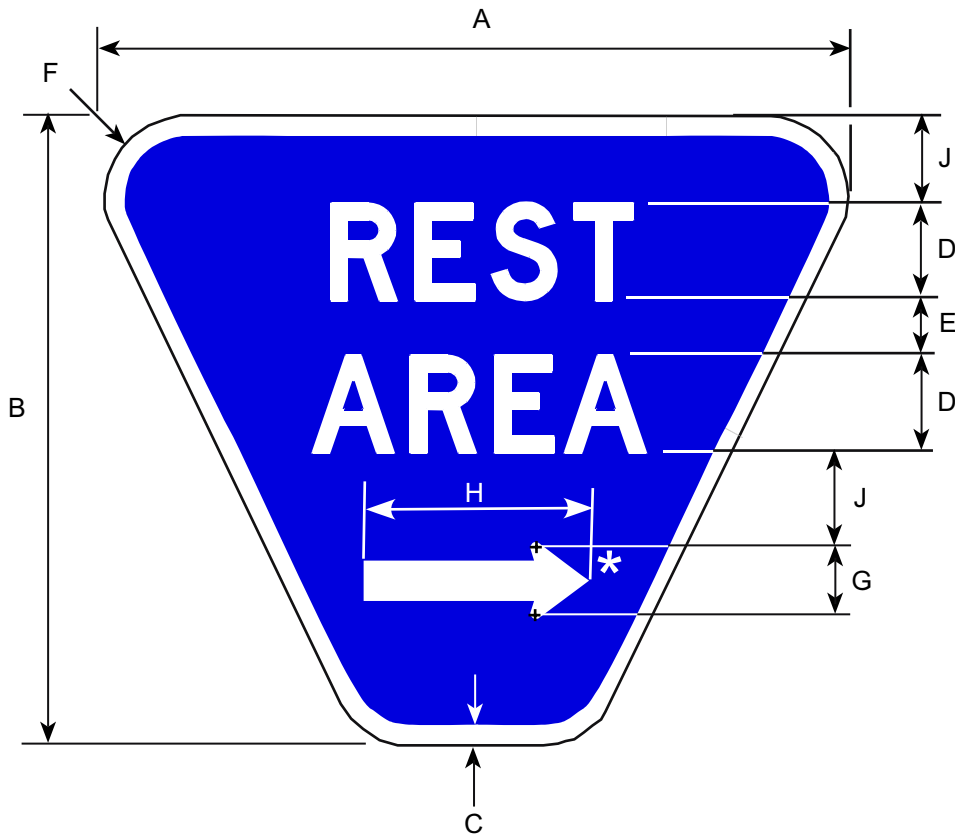

*See Appendix B-1 for standard arrow details.

Border and Legend: White
Background: Blue

Road Class	Dimensions (inches)								
	A	B	C	D	E	F	G	H	J
Minimum	36	30	0.63	4D	3.0	3.0	4.0	8.0	4.0
Conventional	48	40	1.0	6D	5.0	4.0	6.0	9.0	5.0

DESTINATION SIGNS - SCENIC AREA

D6-1 to D6-4A

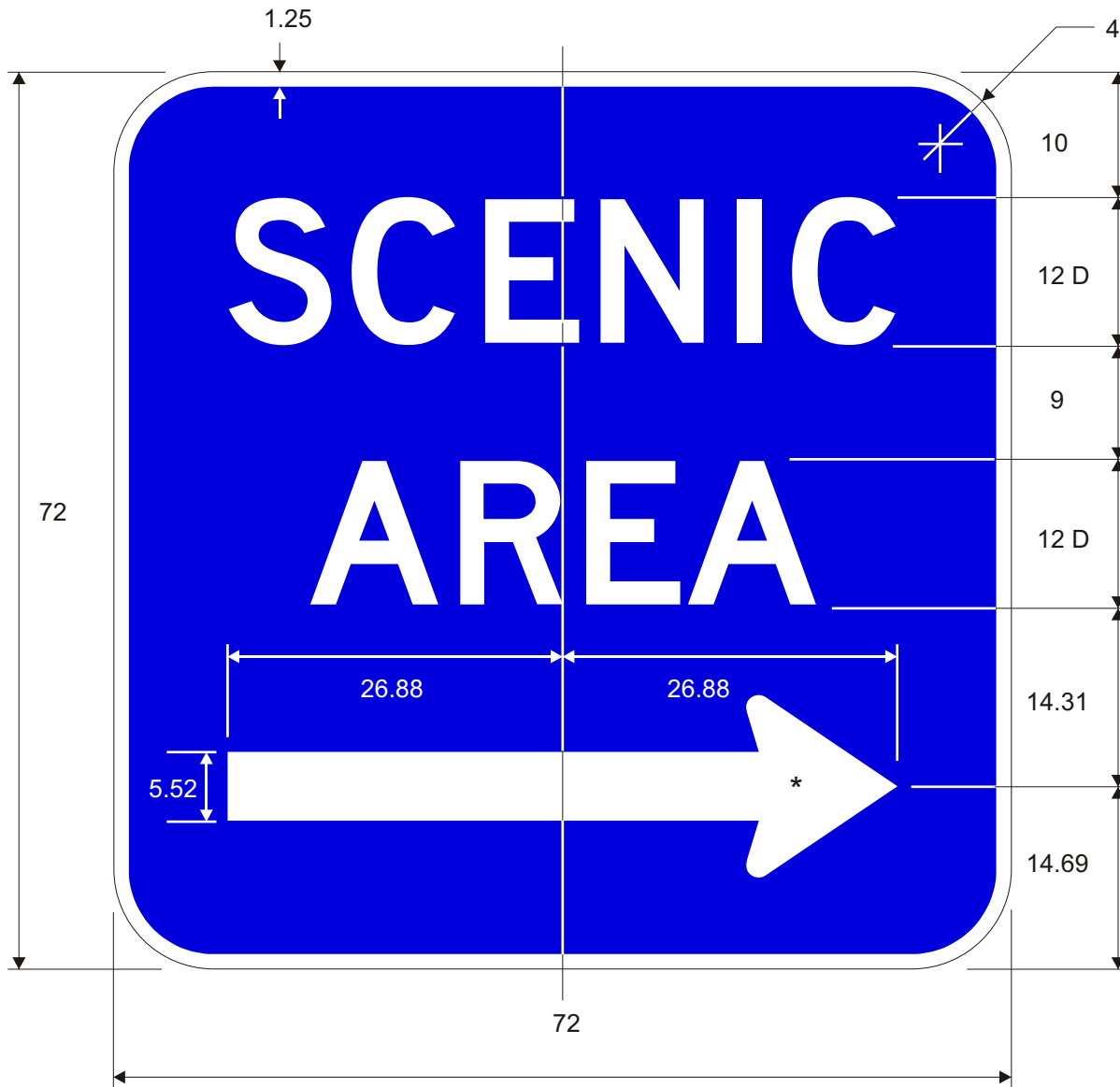

* See Appendix B-1 for Standard Arrow Details.
 For SCENIC OVERLOOK use 84" width.

Code	Variable Legend
A	AREA
B	VIEW
C	OVERLOOK

Example: D6-1B refers to "SCENIC VIEW"

Border and Legend: White
 Background: Blue

D6-2_
D6-3_

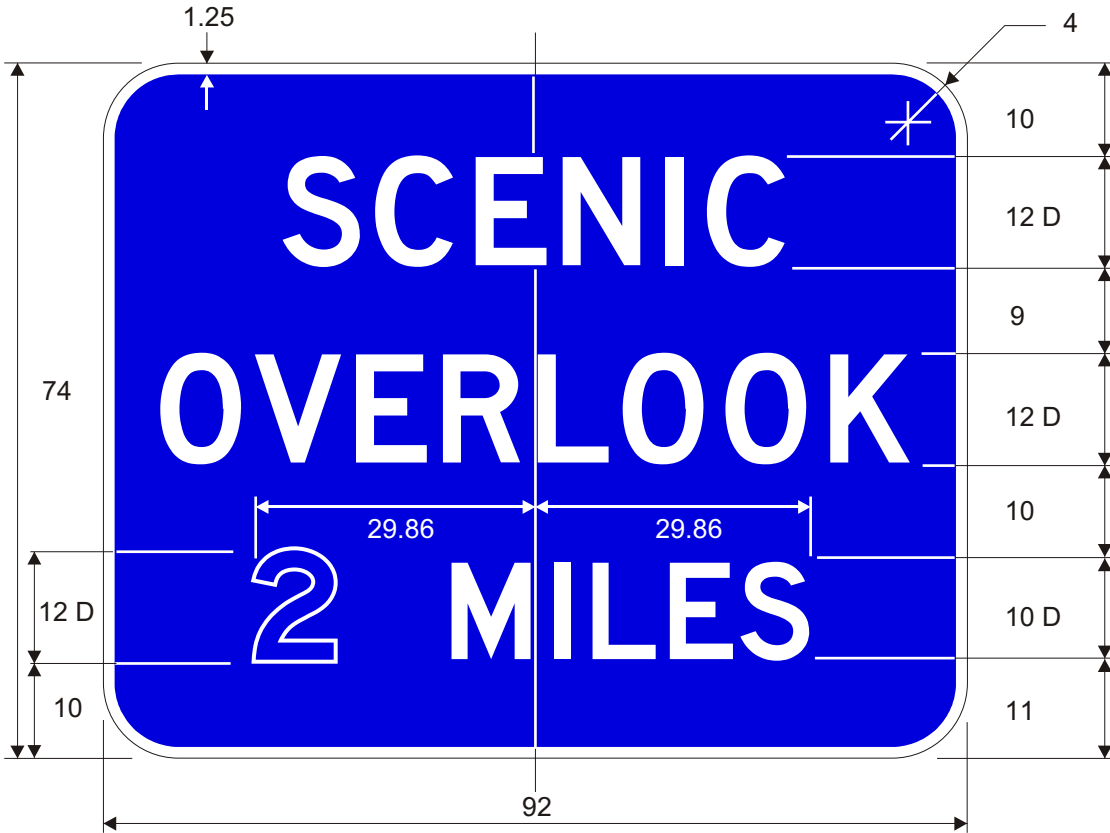

D6-2

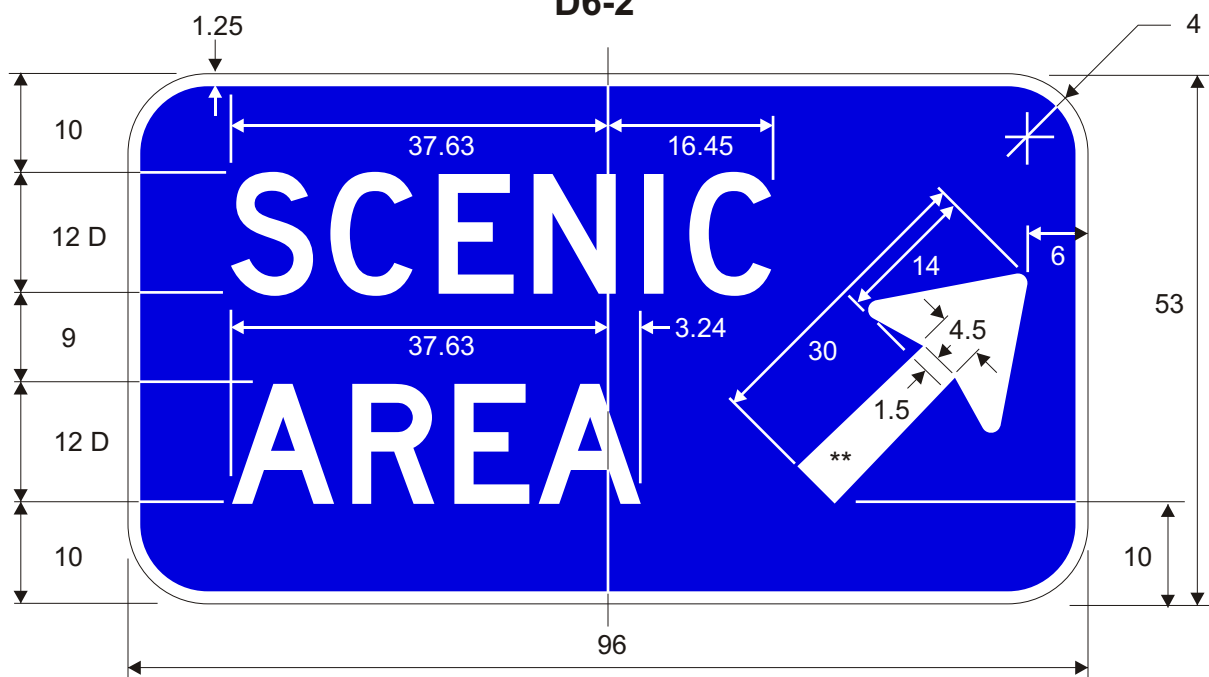

D6-3

Code	Variable Legend
A	AREA
B	VIEW
C	OVERLOOK

Example: D6-2B refers to "SCENIC VIEW 2 MILES"

* See Appendix B-1 for Standard Arrow Details.

Border and Legend: White
Background: Blue

D6-4 D6-4A

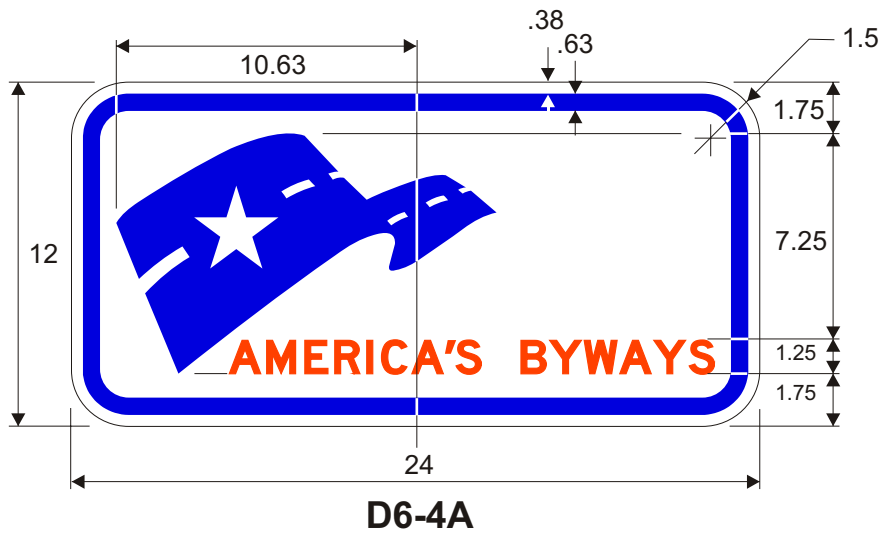
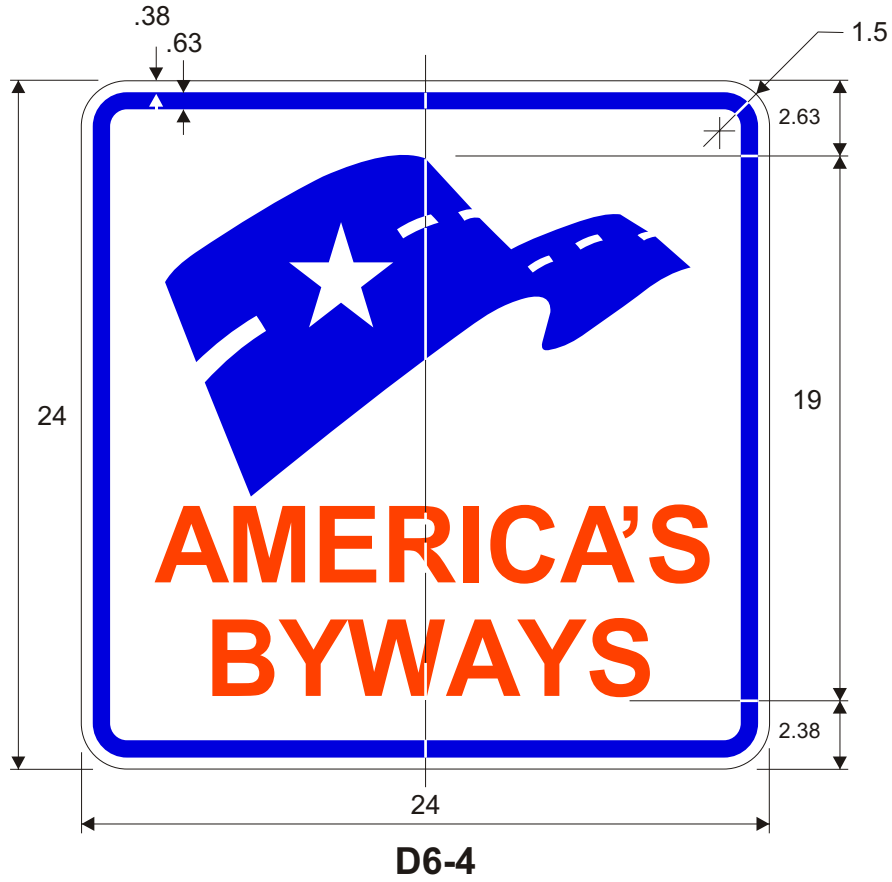

Border and Symbol: Blue
Background: White
Legend: Red

DESTINATION SIGNS - RECREATION

D7-1 to D7-RW

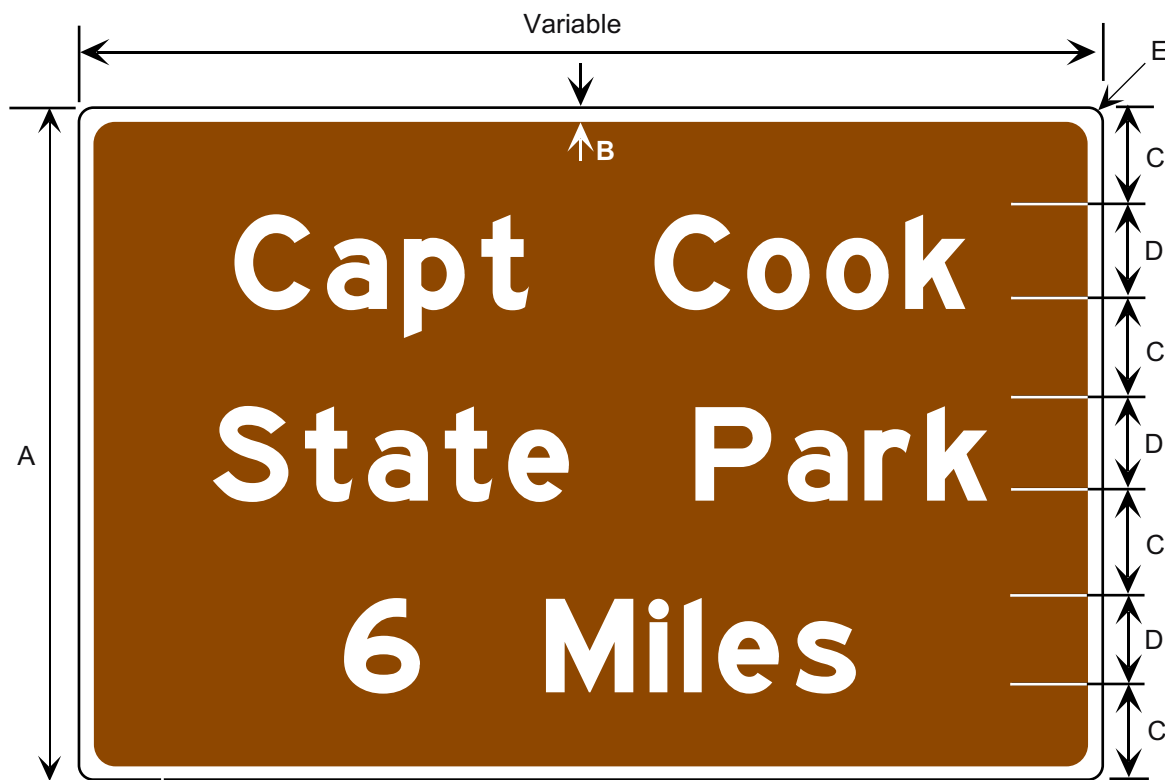

Border and Legend: White
 Background: Brown

Prior to the 2002 publication of this manual,
 this sign was numbered D7-3.

Road Class	Dimensions (inches)				
	A	B	C	D	E
Conv & Min	42	1.25	6	6/4	2.25

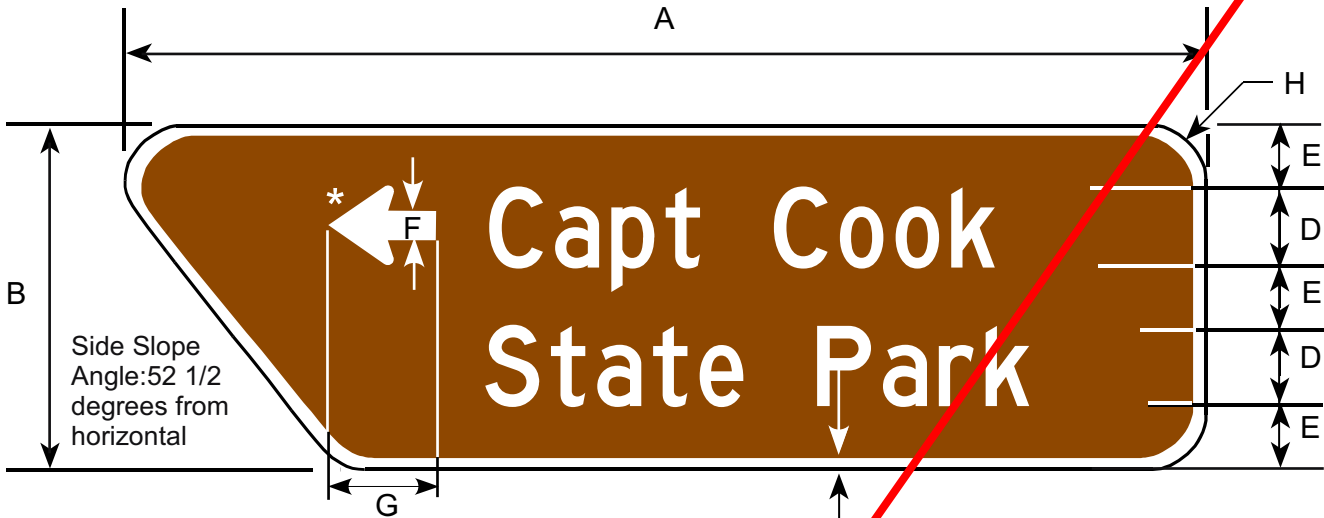

Angle the side of the sign the arrow is on.

Border and Legend: White
Background: Brown

* See Appendix B-1 for Standard Arrow

This drawing has been replaced with:
D7-2
Two Line Trapezoidal Destination &
Arrow
(11/09/09).

Click on the drawing number in the
upper right corner to go to the Interim
Addenda web page.

Prior to the 2002 publication of this manual,
this sign was numbered D7-2A.

Road Class	Dimensions (inches)							
	A	B	C	D	E	F	G	H
Minimum	VAR	30	0.75	6/4	6.0	2.25	9.0	3.0
Conventional	VAR	30	1.5	8/6	8.0	3.0	12	6.0

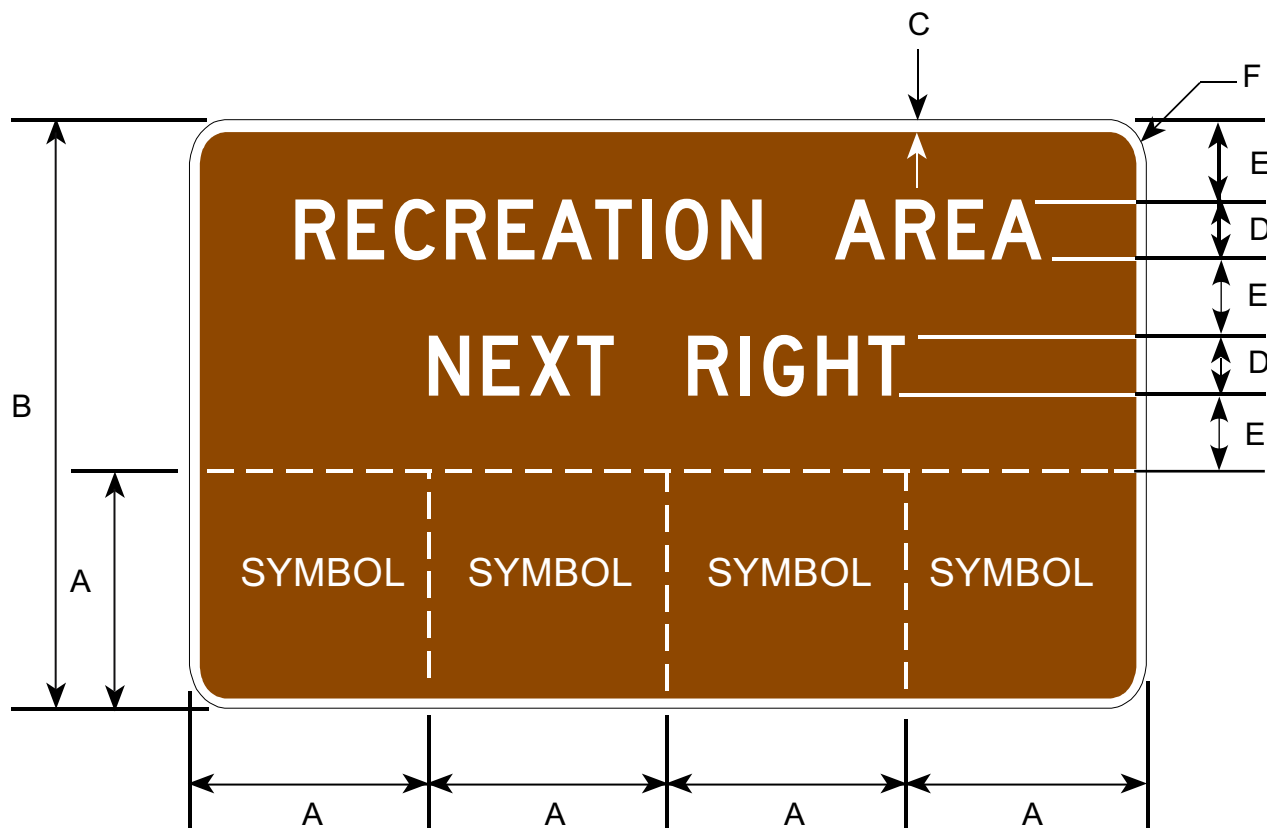

Border and Legend: White
Background: Brown

Road Class	Dimensions (inches)					
	A	B	C	D	E	F
Min & Conv	24	60	0.63	6D	8	1.5

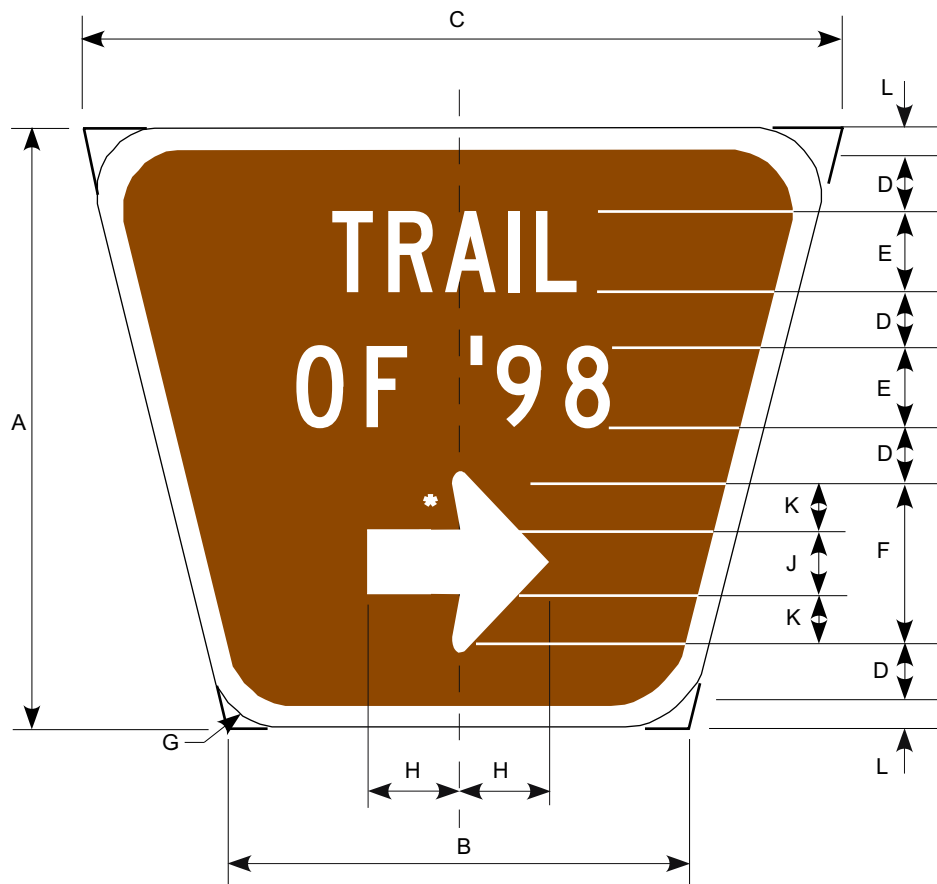

Any of the following legends may be used as alternates for line 3.

Code	Variable Legend
A	500 FT
B	1000 FT
C	1 MILE
D	1/2 MILE
E	1500 FT
F	AHEAD
G	NEXT RIGHT

Border and Legend: White
Background: Brown

Prior to the 2002 publication of this manual, this sign was numbered D7-4.

* See Appendix B-1 for standard arrow details.



Additional alternates for line 3.

Road Class	Dimensions (inches)											
	A	B	C	D	E	F	G	H	J	K	L	N
Conventional	36	29	48	3.5	5C	10	3.0	4.06	4	3	1	4C
Expwy/Fwy	42	38	60	4.0	6C	12	3.5	6.38	6	3	1	5C

D7-RA Accommodation Plates (1 of 2)



Campfire
RA-030



Laundry
D7-RA-060



Information
D7-RA-080



Sleeping Shelter
D7-RA-110 *

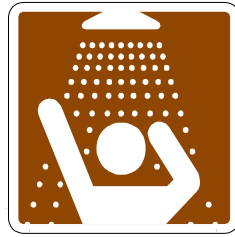

Showers
D7-RA-130

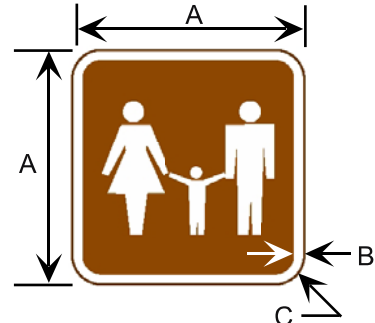

Family Rest Room
D7-RA-150



Helicopter
D7-RA-160

* For Non-Road Use

Border and Legend: White
Background: Brown

Make symbol proportional to
graphic shown.

Road Class	Dimensions (inches)		
	A	B	C
Minimum	18	0.38	1.50
Conventional	24	0.63	1.50
Expwy / Fwy	30	0.75	1.88

D7-RA Accommodation Plates (2 of 2)



Bus Stop
D7-RA-020

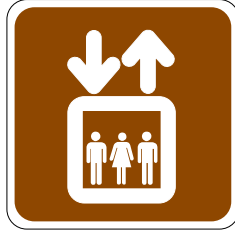

Elevator
D7-RA-040



Kennel
D7-RA-050



Locker
D7-RA-70



Parking
D7-RA-80

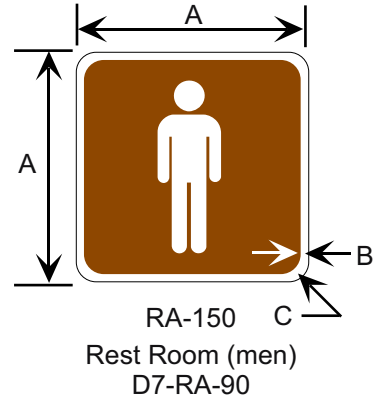

Rest Room (women)
D7-RA-100

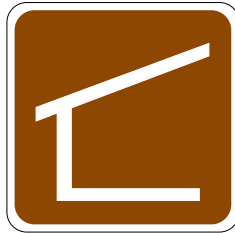

Shelter (trail)
D7-RA-120

Border and Legend: White
Background: Brown

Make symbol proportional to
graphic shown.

Road Class	Dimensions (inches)		
	A	B	C
Minimum	18	0.38	1.50
Conventional	24	0.63	1.50
Expwy / Fwy	30	0.75	1.88

D7-RG General Information Plates (1 of 2)

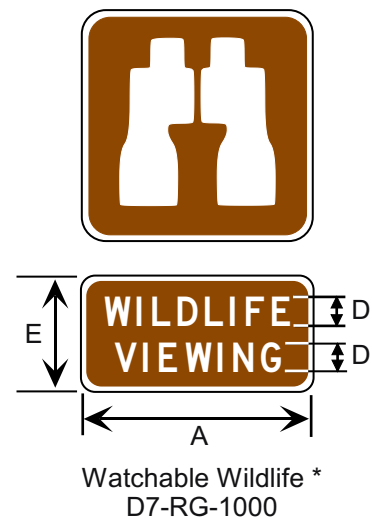
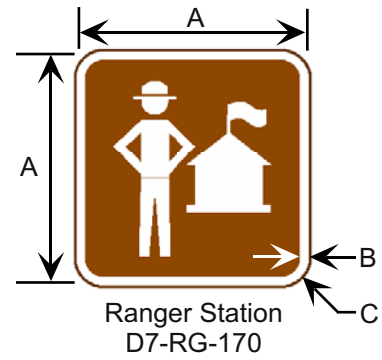
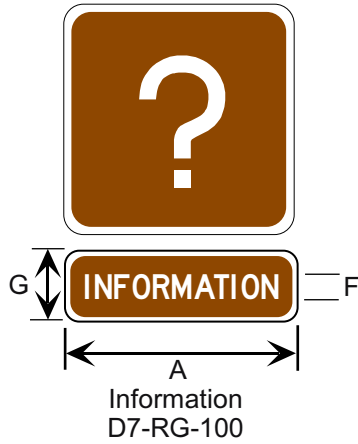

Border and Legend: White
Background: Brown

Make symbol proportional to graphics shown.

* The Watchable Wildlife plates may only be used for officially-approved sites published in the "Alaska Wildlife Viewing Guide," or similar guides developed by ADF&G.

Road Class	Dimensions (inches)						
	A	B	C	D	E	F	G
Minimum	18	0.38	1.50	2E	9	2C	6
Conventional	24	0.63	1.50	3D	12	2E	6
Expwy / Fwy	30	0.75	1.88	4D	15	3D	9

D7-RG General Information Plates (2 of 2)



Automobile
D7-RG-010



Bear Viewing Area
D7-RG-020

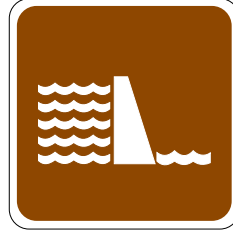

Dam
D7-RG-030

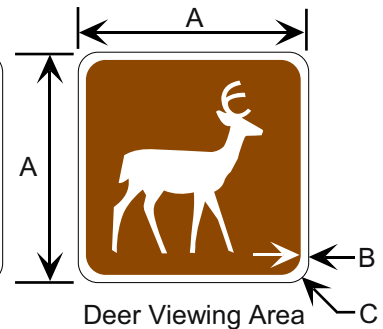

Deer Viewing Area
D7-RG-040



Drinking Water
D7-RG-060



Environmental Study
D7-RG-060



Falling Rock
D7-RG-070

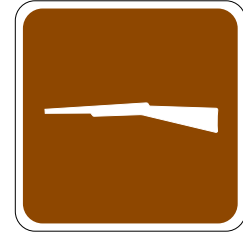

Firearms
D7-RG-080

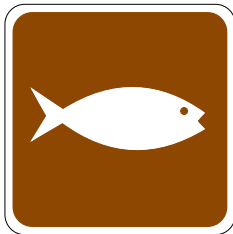

Fish Hatchery
D7-RG-090



Leashed Pets
D7-RG-110



Lighthouse
D7-RG-120



Lookout Tower
D7-RG-140



Pedestrian Crossing
D7-RG-150



Point of Interest
D7-RG-160



Smoking
D7-RG-180



Truck
D7-RG-190



Tunnel
D7-RG-200

Border and Legend: White
Background: Brown
Make symbol proportional to
graphics shown.

Road Class	Dimensions (inches)		
	A	B	C
Minimum	18	0.38	1.50
Conventional	24	0.63	1.50
Expwy / Fwy	30	0.75	1.88

D7-RL Land Recreation Plates (1 of 2)



Amphitheater
RL-010



Rock Climbing
RL-030

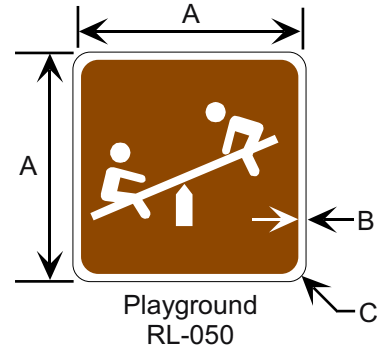

Playground
RL-050



Hiking
RL-100



Horse Riding
RL-110



Interpretive Trail
RL-130



4 WD Trail
RL-140



Motorcycle Trail
RL-150



ATV Trail
RL-170



Archery
RL-190



Hang Gliding
RL-210



Golf
RL-500

Road Class	Dimensions (inches)		
	A	B	C
Minimum	18	0.38	1.50
Conventional	24	0.63	1.50
Expwy / Fwy	30	0.75	1.88

Border and Legend: White
Background: Brown

Make symbol proportional to graphic shown.

D7-RL Land Recreation Plates (2 of 2)



Hunting
RL-040



Rock Collecting
RL-060

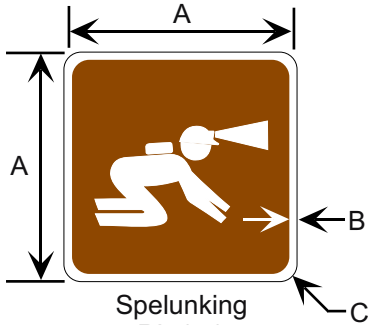

Spelunking
RL-070



Stable
RL-080



Trail (bicycle)
RL-090

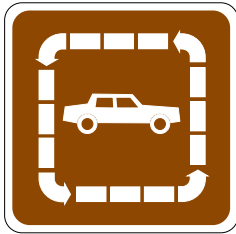

Trail (auto)
RL-120

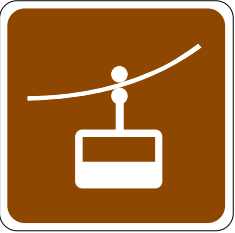

Tramway
RL-160

Border and Legend: White
Background: Brown

Make symbol proportional to
graphic shown.

Road Class	Dimensions (inches)		
	A	B	C
Minimum	18	0.38	1.50
Conventional	24	0.63	1.50
Expwy / Fwy	30	0.75	1.88

D7-RM Motorist Service Plates (1 of 2)



Tent Camping
D7-RM-010



Trailer Camping
D7-RM-020

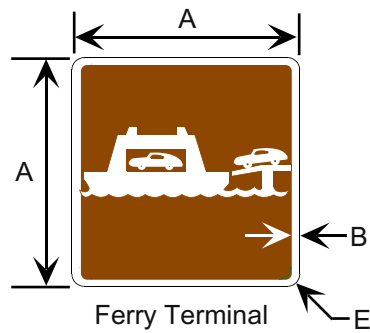

Ferry Terminal
D7-RM-030



Food
D7-RM-050



Gas
D7-RM-060

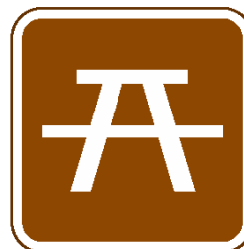

Picnic Area
D7-RM-120

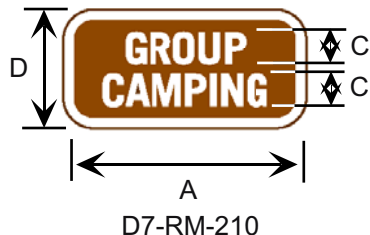

D7-RM-210



Telephone
D7-RM-150



Motor Home
D7-RM-200

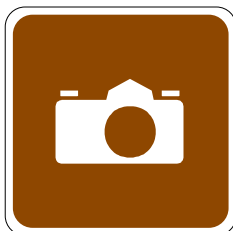

Viewing Area
D7-RM-170



D7-RM-220

Road Class	Dimensions (inches)				
	A	B	C	D	E
Minimum	18	0.38	2C	9	1.50
Conventional	24	0.63	3C	12	1.50
Expwy / Fwy	30	0.75	4C	15	1.88

Border and Legend: White
Background: Brown

Make symbol proportional to graphic shown.

D7-RM Motorist Service Plates (2 of 2)



First Aid
D7-RM-040

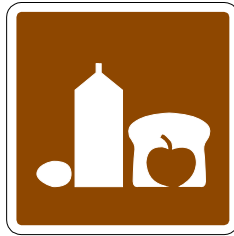

Grocery Store
D7-RM-070

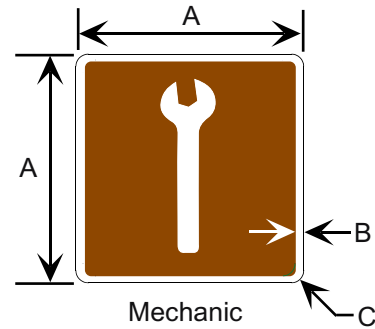

Mechanic
D7-RM-100



Post Office
D7-RM-110

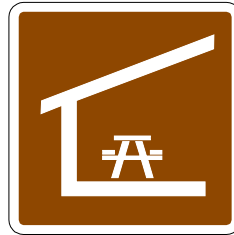

Picnic Shelter
D7-RM-130



Rest Room
D7-RM-140

Border and Legend: White
Background: Brown

Make symbol proportional to
graphic shown.

Road Class	Dimensions (inches)		
	A	B	C
Minimum	18	0.38	1.50
Conventional	24	0.63	1.50
Expwy / Fwy	30	0.75	1.88

D7-RS Winter Recreation Plates (1 of 2)



Skating
D7-RS-010



Ski Jumping
D7-RS-020



Cross-Country Skiing
D7-RS-040



Downhill Skiing
D7-RS-050



Sledding
D7-RS-060

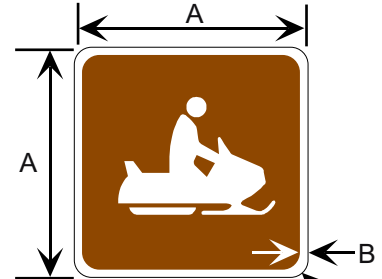

Snow Mobiling
D7-RS-070



Winter Rec Area
D7-RS-090



Chair Lift
D7-RS-100

Border and Legend: White
Background: Brown

Make symbols proportional
to the graphics shown.

Road Class	Dimensions (inches)		
	A	B	C
Minimum	18	0.38	1.50
Conventional	24	0.63	1.50
Expwy / Fwy	30	0.75	1.88

D7-RS Winter Recreation Plates (2 of 2)



Skiing (bobbing)
D7-RS-030

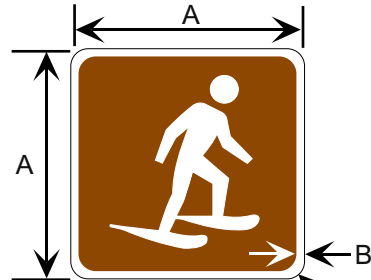

Snowshoeing
D7-RS-080

Border and Legend: White
Background: Brown

Make symbols proportional
to the graphics shown.

Road Class	Dimensions (inches)		
	A	B	C
Minimum	18	0.38	1.50
Conventional	24	0.63	1.50
Expwy / Fwy	30	0.75	1.88

D7-RW Water Recreation Plates (1 of 2)



Canoeing
D7-RW-020

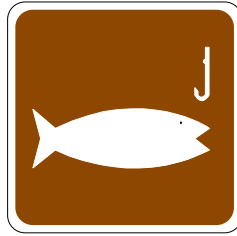

Fishing
D7-RW-050

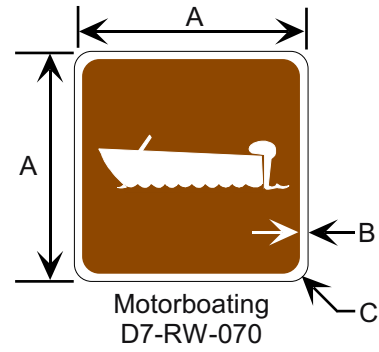

Motorboating
D7-RW-070



Launch Ramp
D7-RW-080



Sailboating
D7-RW-100



Water Skiing
D7-RW-110



Swimming
D7-RW-130



Fishing Pier
D7-RW-160



Hand Launch
D7-RW-170



Kayaking
D7-RW-190



Wind Surfing
D7-RW-210

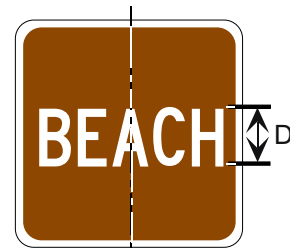

D7-RW-500

Road Class	Dimensions (inches)			
	A	B	C	D
Minimum	18	0.38	1.50	4C
Conventional	24	0.63	1.50	6C
Expwy / Fwy	30	0.75	1.88	8C

Border and Legend: White
Background: Brown

Make symbol proportional to graphic shown.

D7-RW Water Recreation Plates (2 of 2)



Boat Tours
D7-RW-010



Diving
D7-RW-010

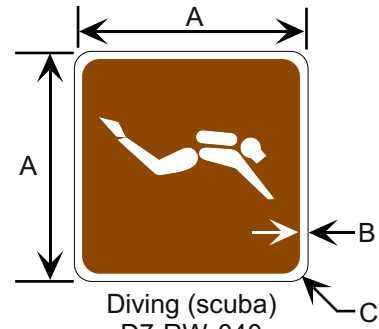

Diving (scuba)
D7-RW-040



Marina
D7-RW-060



Rowboating
D7-RW-090



Surfing
D7-RW-120



Wading
D7-RW-140

Border and Legend: White
Background: Brown

Make symbol proportional to
graphic shown.

Road Class	Dimensions (inches)		
	A	B	C
Minimum	18	0.38	1.50
Conventional	24	0.63	1.50
Expwy / Fwy	30	0.75	1.88

DESTINATION SIGNS - WEIGHT STATION/ CUSTOMS

D8-1 to D8-104



Border and Legend: White
Background: Green

Road Class	Dimensions (inches)							
	A	B	C	D	E	F	G	H
Conventional	60	48	1.5	6.0	8E	6E	6.0	3.0
Expressway	78	60	2.0	8.0	10E	8E	7.0	4.0
Freeway	96	72	2.0	9.0	12E	10E	9.0	5.0

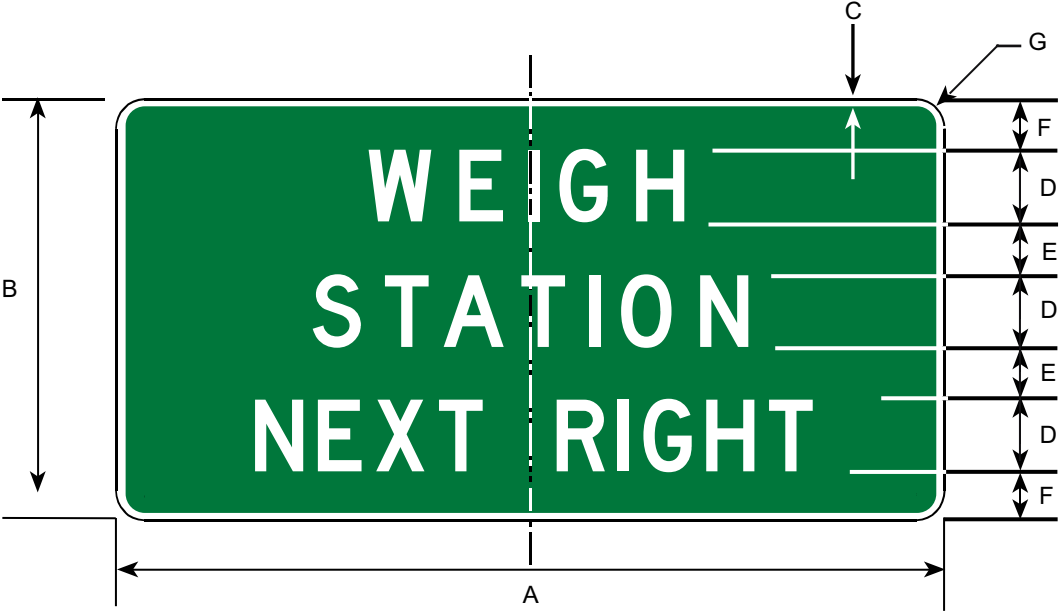

Border and Legend: White
Background: Green

Road Class	Dimensions (inches)						
	A	B	C	D	E	F	G
Conventional	72	36	1.5	6D	4.0	5.0	4.0
Expy/Fwy	108	60	2.0	10D	7.0	8.0	6.0

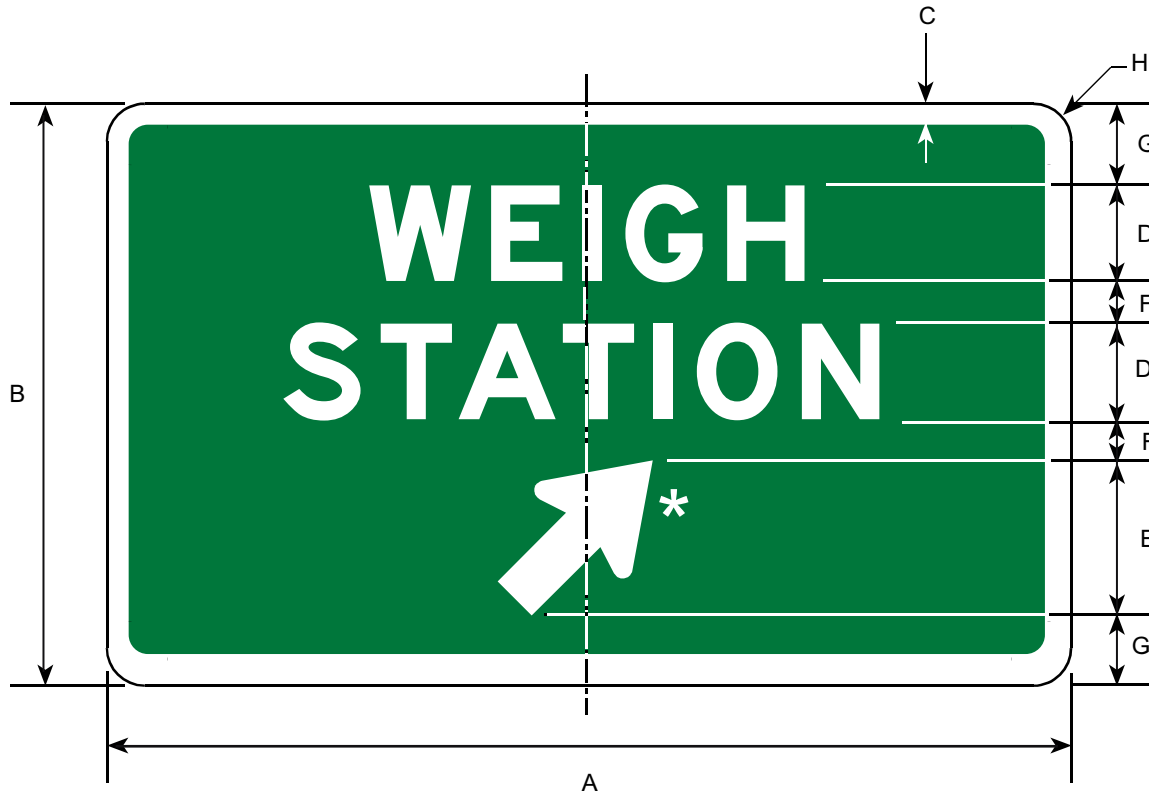

Border and Legend: White
Background: Green

*See Appendix B-4 for Arrow Details.

Road Class	Dimensions (inches)							
	A	B	C	D	E	F	G	H
Conventional	60	36	1.5	6E	10.88	2.5	4.06	4.0
Expwy/Fwy	84	60	2.0	10E	14.75	5.0	7.63	6.0

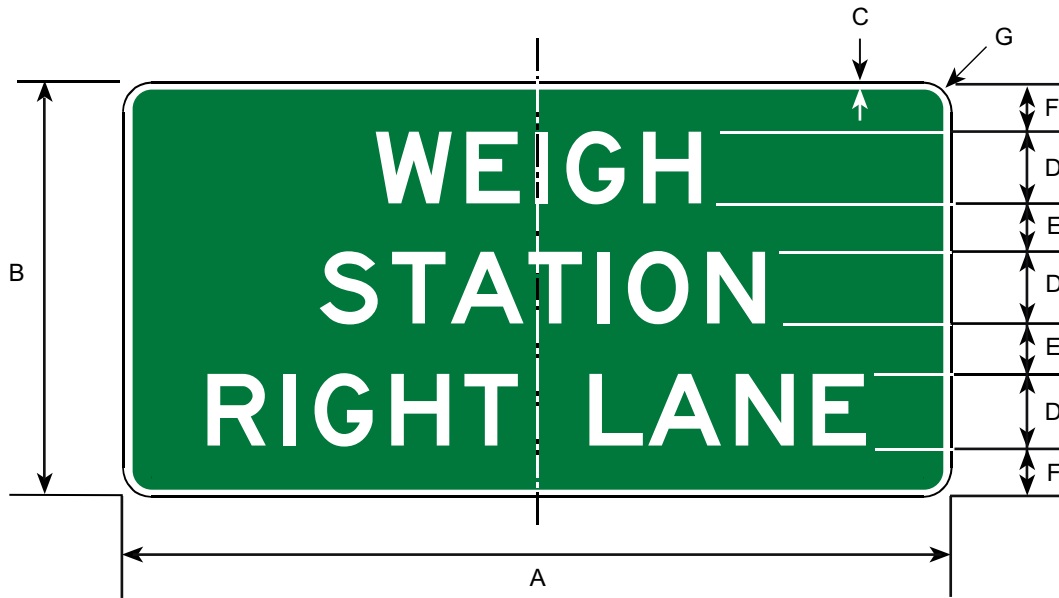

Border and Legend: White
Background: Green

Prior to the 2002 publication of this manual,
this sign was numbered D8-2.

Road Class	Dimensions (inches)						
	A	B	C	D	E	F	G
Conventional	72	36	1.5	6D	4.0	5.0	2.3
Expwy/Fwy	108	60	2.0	10D	7.0	8.0	3.8

D8-101

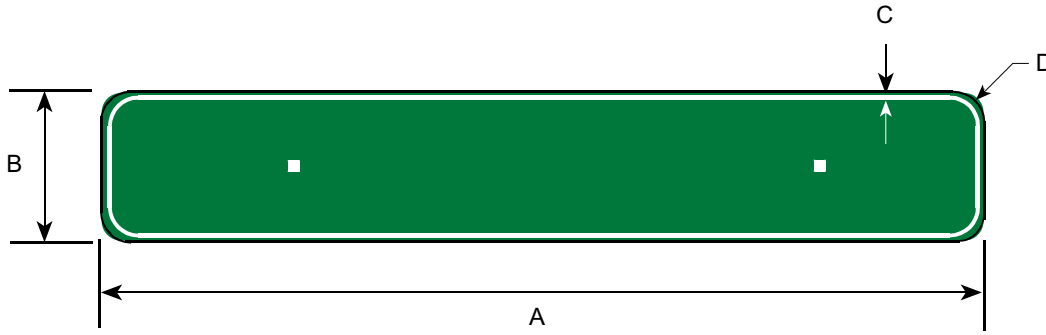

Road Class	Dimensions (inches)			
	A	B	C	D
Conventional	72	12	1.5	0.75
Expwy/Fwy	108	24	2.0	1.5

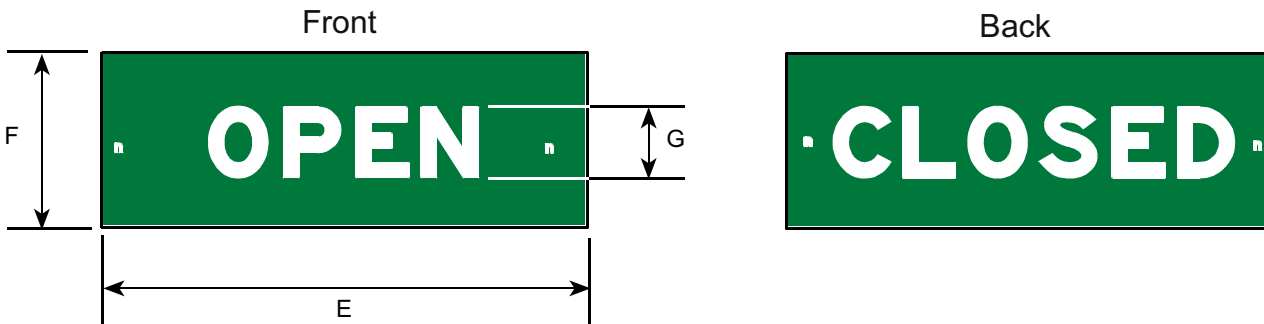

Road Class	Dimensions (inches)		
	E	F	G
Conventional	42	8	6E
Expwy/Fwy	66	12	10E

Border and Legend: White
Background: Green

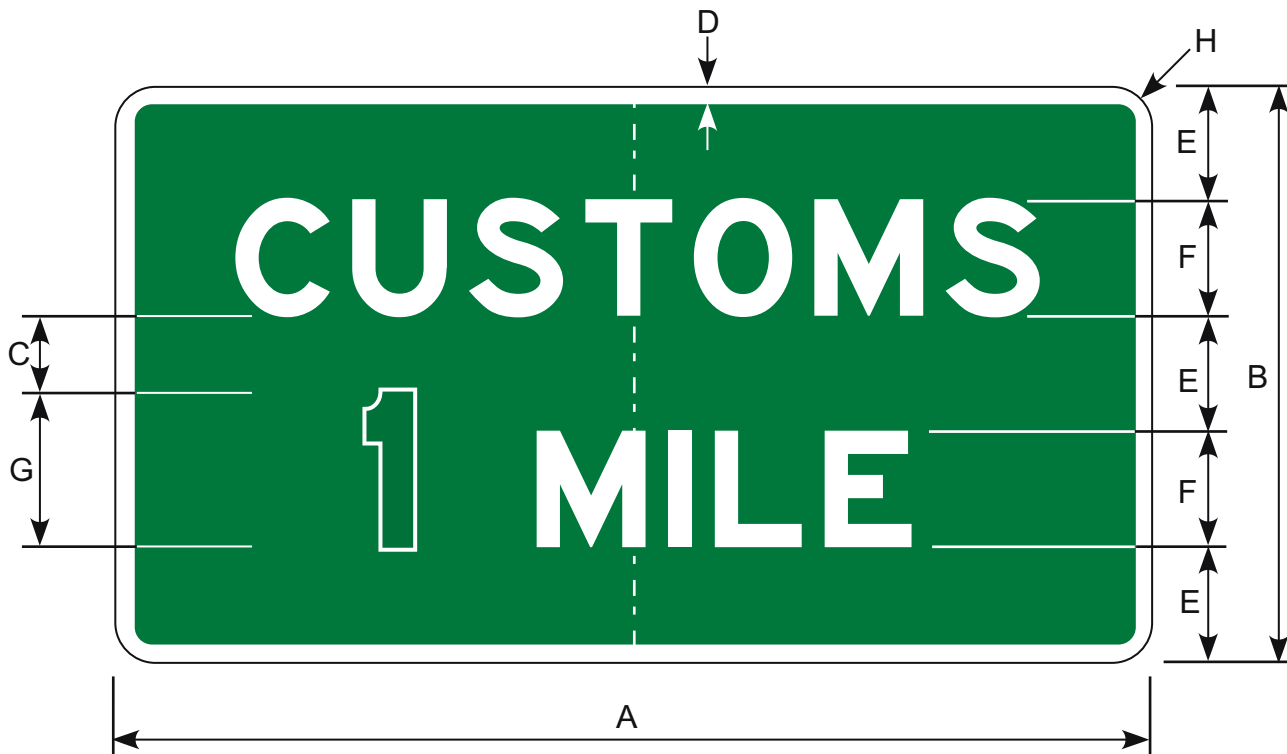

Border and Legend: White
Background: Green

Prior to the 2002 publication of this manual,
this sign was numbered D8-6C.

Road Class	Dimensions (inches)							
	A	B	C	D	E	F	G	H
Conv/Min	54	30	4	1	6	6E	8E	2.25
Expwy/Fwy	108	60	8	2	12	12E	16E	5.00

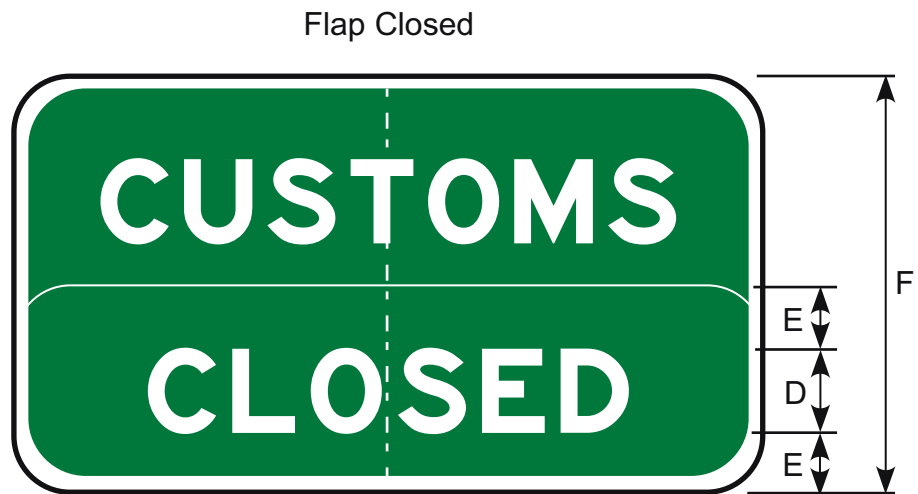
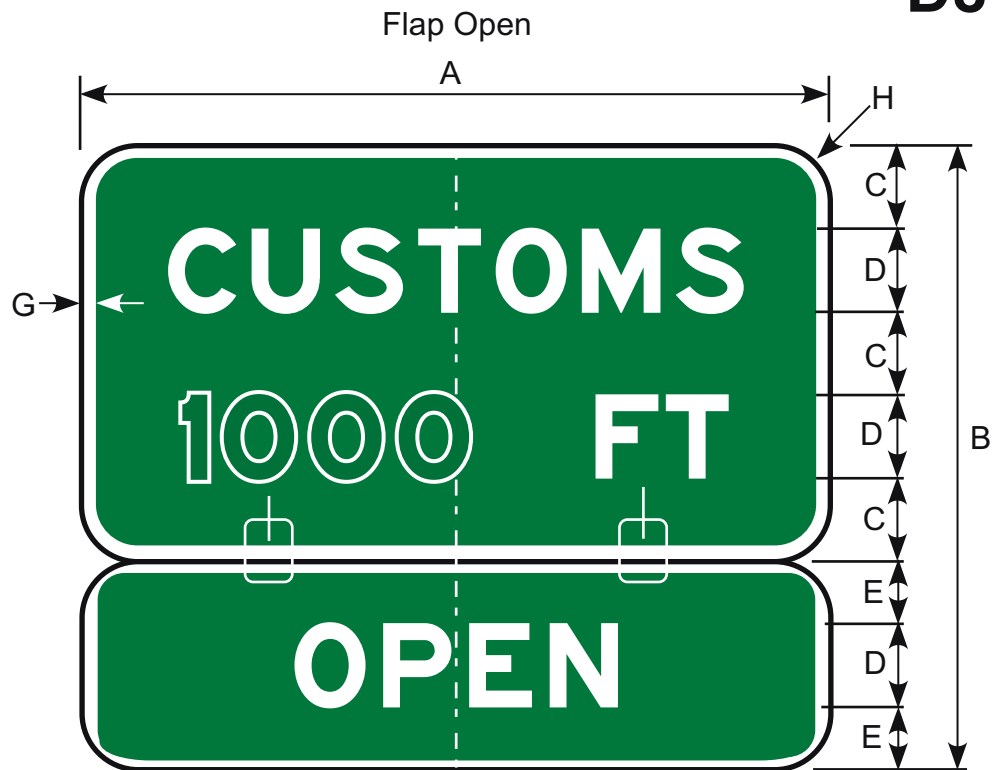

Border and Legend: White
Background: Green

Prior to the 2002 publication of this manual, this sign was numbered D8-8.

Road Class	Dimensions (inches)							
	A	B	C	D	E	F	G	H
Conv/Min	54	46	6.0	6E	5.0	30	0.75	4.0
Expwy/Fwy	72	60	8.0	8E	6.0	40	2.0	4.0

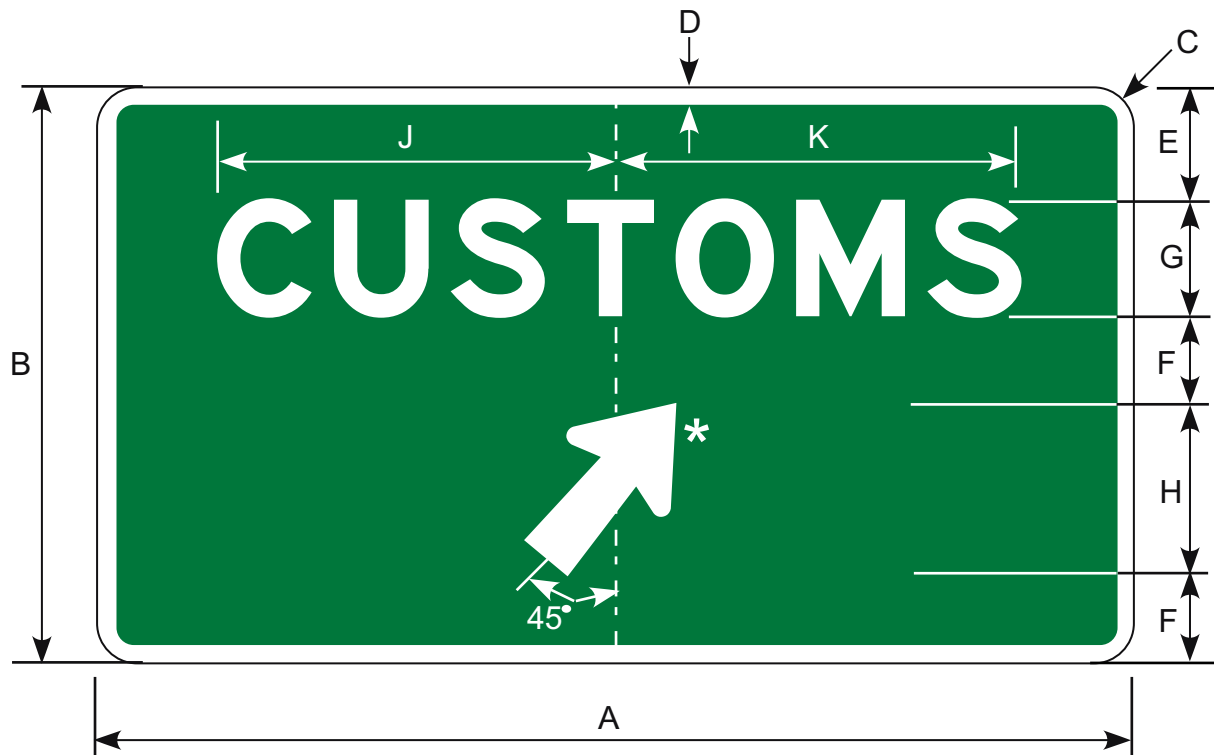

Border and Legend: White
Background: Green

*See Appendix B-4 for Arrow Details.

Prior to the 2002 publication of this manual,
this sign was numbered D8-7.

Road Class	Dimensions (inches)									
	A	B	C	D	E	F	G	H	J	K
Conv/Min	54	30	2.25	1.0	6.0	3.5	6E	11	20.75	20.81
Expwy/Fwy	108	60	3.75	2.0	12	10.0	12E	15	41.50	41.63

DESTINATION SIGNS - GENERAL SERVICES

D9-1 to D9-308

General Service Plates (1 of 3)

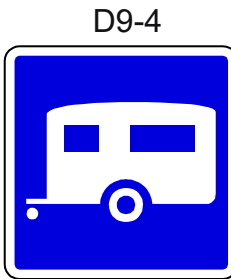
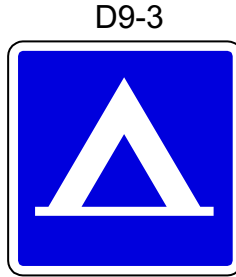
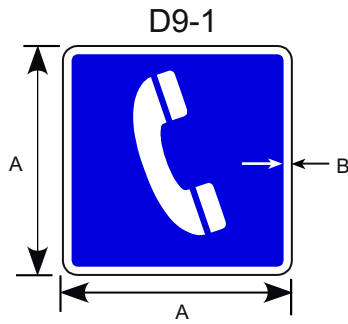

Border and Legend: White
Background: Blue
Slashes: Red

Make symbols proportional
to the graphics shown.

More detail for some of these plates
is shown on following pages.

Road Class	Dimensions (inches)	
	A	B
For Use on D9-204, D9-206	18	0.50
Conv/Min	24	0.50
Expressway	30	0.75

General Service Plates (2 of 3)

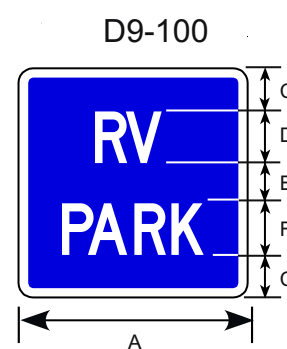
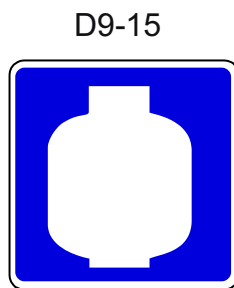
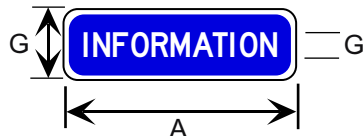
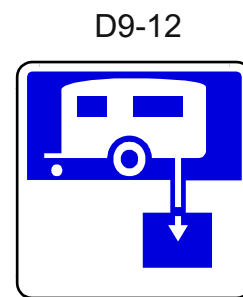
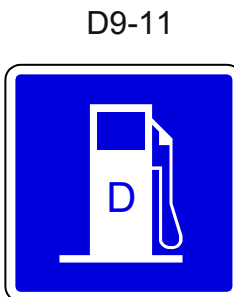
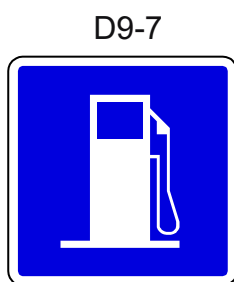
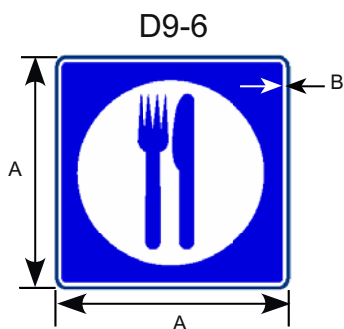

Border and Legend: White
Background: Blue

Make symbol proportional to graphic shown.

More detail for some of these signs is shown on the following pages.

Road Class	Dimensions (inches)							
	A	B	C	D	E	F	G	H
For Use on D9-204, D9-206	18	0.50	3.0	4E	4	4D	6	2C
Conv/Min	24	0.50	4.5	5E	5	5D	6	2E
Expressway	30	0.75	4.5	7E	7	7D	9	3D

General Service Plates (3 of 3)

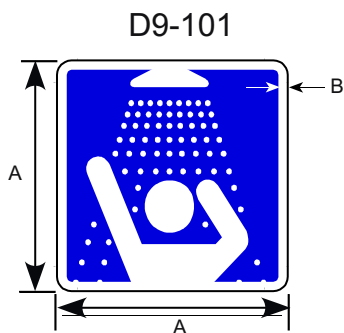

TROOPERS



PARKING



WATER

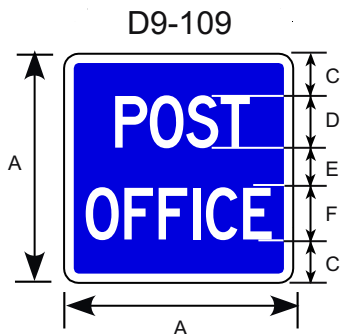

Make symbol proportional to graphic shown.

Educational plaques are optional.

More detail for some of these signs is shown on the following pages.

Border and Legend: White
Background : Blue

Road Class	Dimensions (inches)					
	A	B	C	D	E	F
For Use on D9-204, D9-206	18	0.50	3.0	4E	4	4C
Conv/Min	24	0.50	4.5	5E	5	5C
Expressway	30	0.75	4.5	7E	7	6C

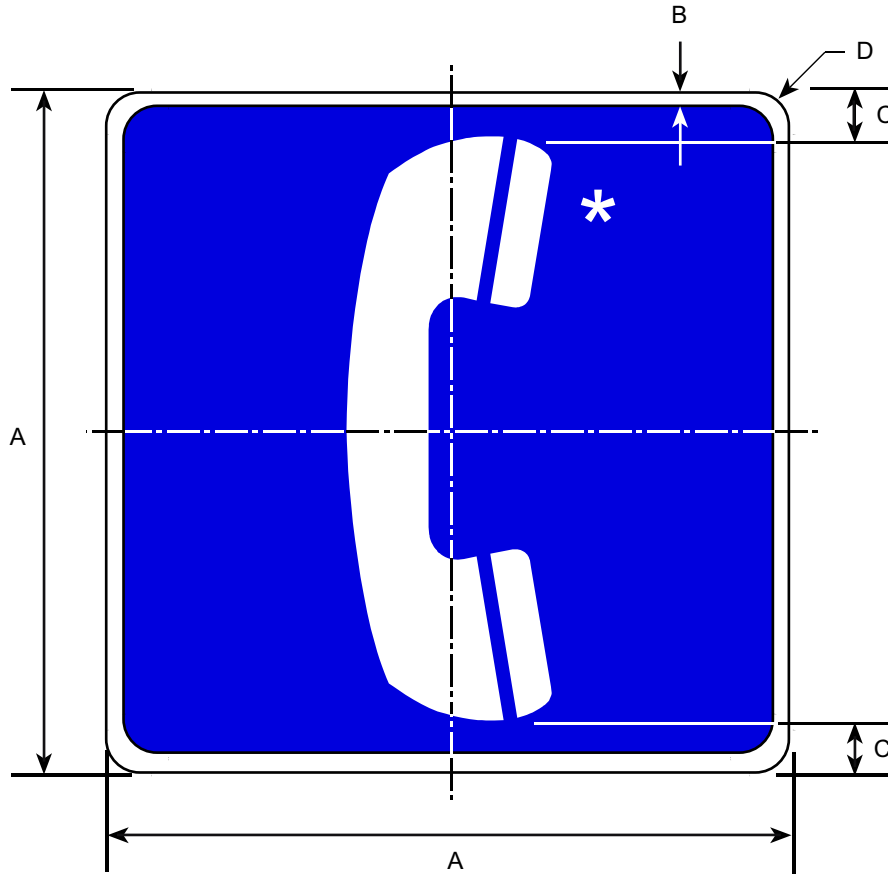

Border and Legend: White
Background: Blue

* Make symbol proportional to the graphic shown.

Road Class	Dimensions (inches)			
	A	B	C	D
Minimum	18	0.50	1.0	1.50
Conventional	24	0.50	1.5	1.50
Oversized	30	0.75	2.0	1.88

D9-1A

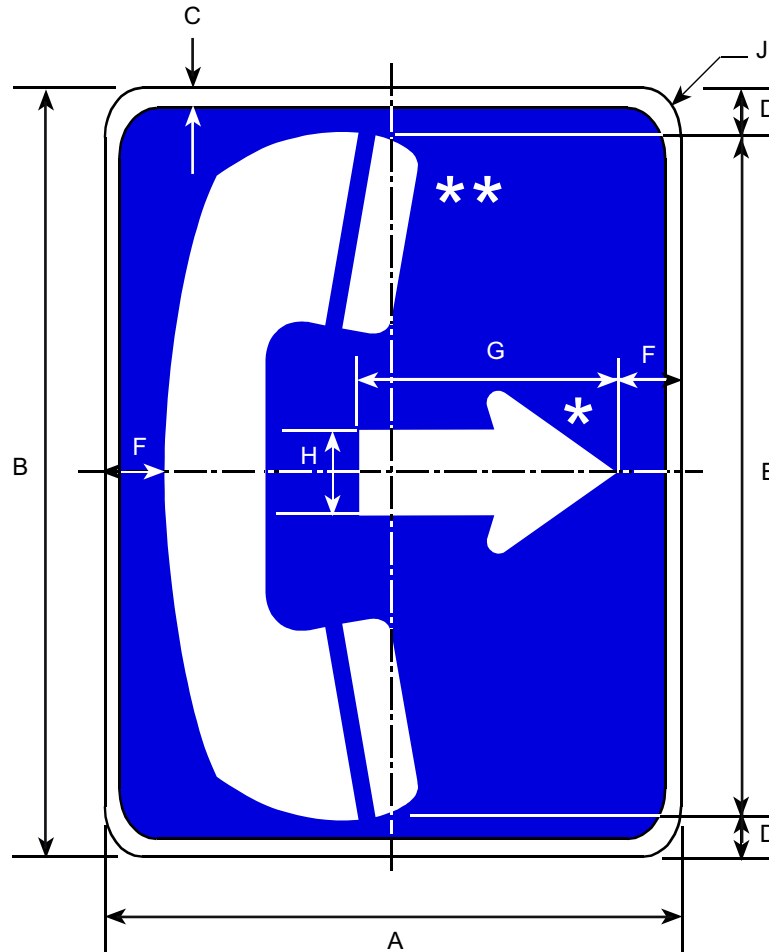

Border and Legend: White
Background: Blue

* See Appendix B-1 for standard arrow details.

** Make symbol proportional to graphic shown.

Prior to the 2002 publication of this manual,
this sign was numbered D9-1.

Road Class	Dimensions (inches)								
	A	B	C	D	E	F	G	H	J
Minimum	18	24	0.50	1.5	21	1.25	8.5	2.0	1.5
Conventional	24	30	0.63	2.0	26	2.5	10.5	2.63	1.5
Oversized	30	36	0.75	2.5	31	3.0	13.25	3.25	1.88

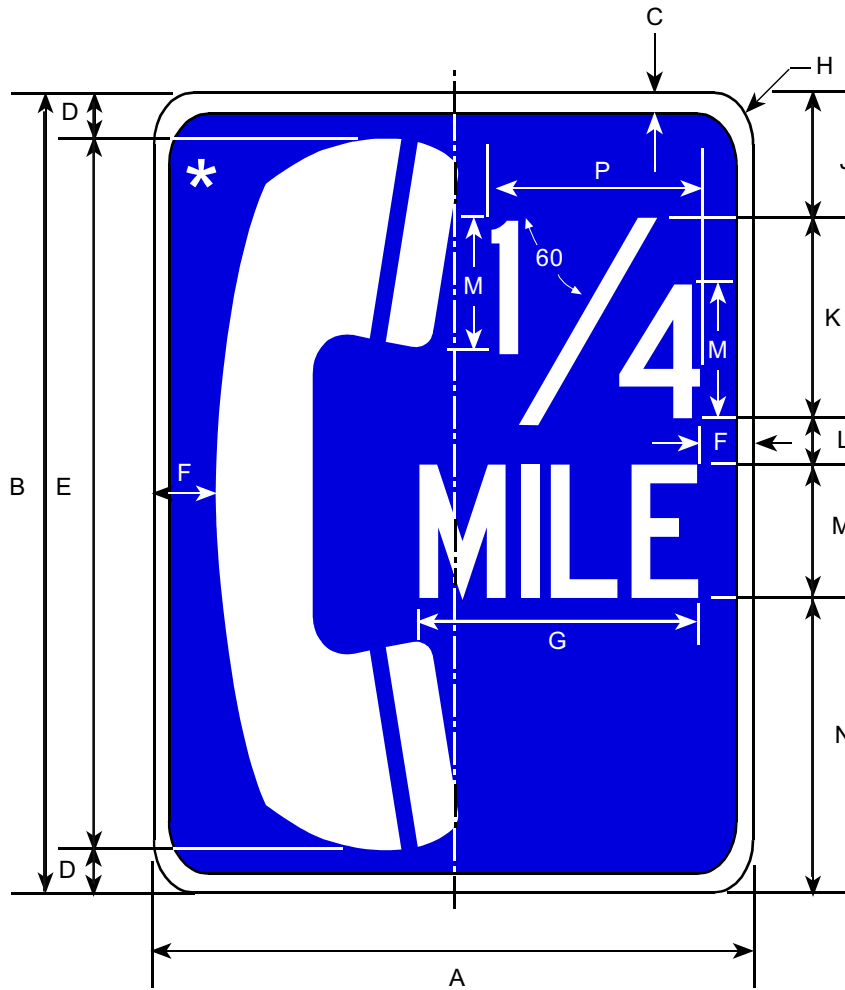

Border and Legend: White
Background: Blue

* Make symbol proportional to graphic shown.

Prior to the 2002 publication of this manual, this sign was numbered D9-1A.

Road Class	Dimensions (inches)													
	A	B	C	D	E	F	G	H	J	K	L	M	N	P
Minimum	18	24	0.50	1.5	21	1.0	9.50	1.50	3.75	6.0	1.5	4C	8.75	8
Conventional	24	30	0.63	2.0	26	1.5	11.88	1.50	4.50	7.5	2.0	5C	11.00	10
Oversized	30	36	0.75	2.5	31	2.0	14.25	1.88	5.00	9.0	2.5	6C	13.50	12

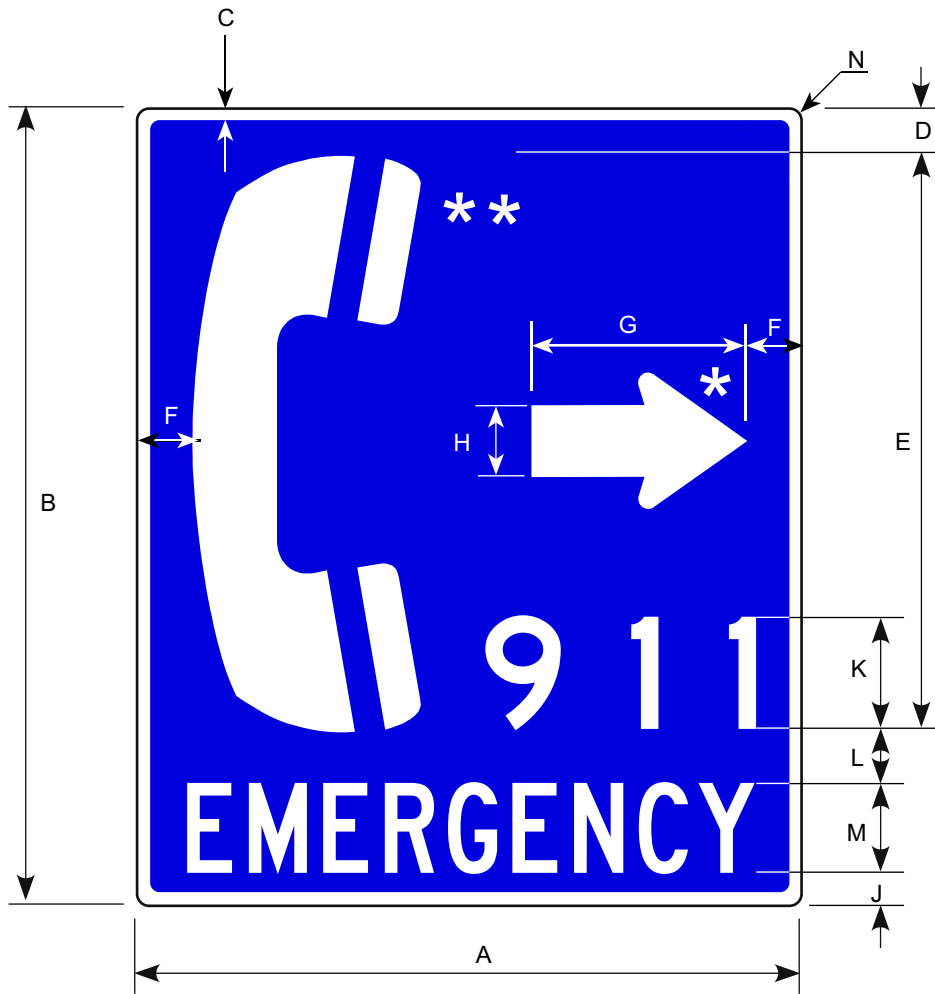

Border and Legend: White
Background: Blue

* See Appendix B-1 for Standard Arrow Details.

** Symbol and arrow reversible. Make symbol proportional to graphic shown.

Road Class	Dimensions (inches)												
	A	B	C	D	E	F	G	H	J	K	L	M	N
Conv & Min	30	36	0.63	2.0	26	2.5	10.5	2.63	1.5	5D	2.5	4C	1.5

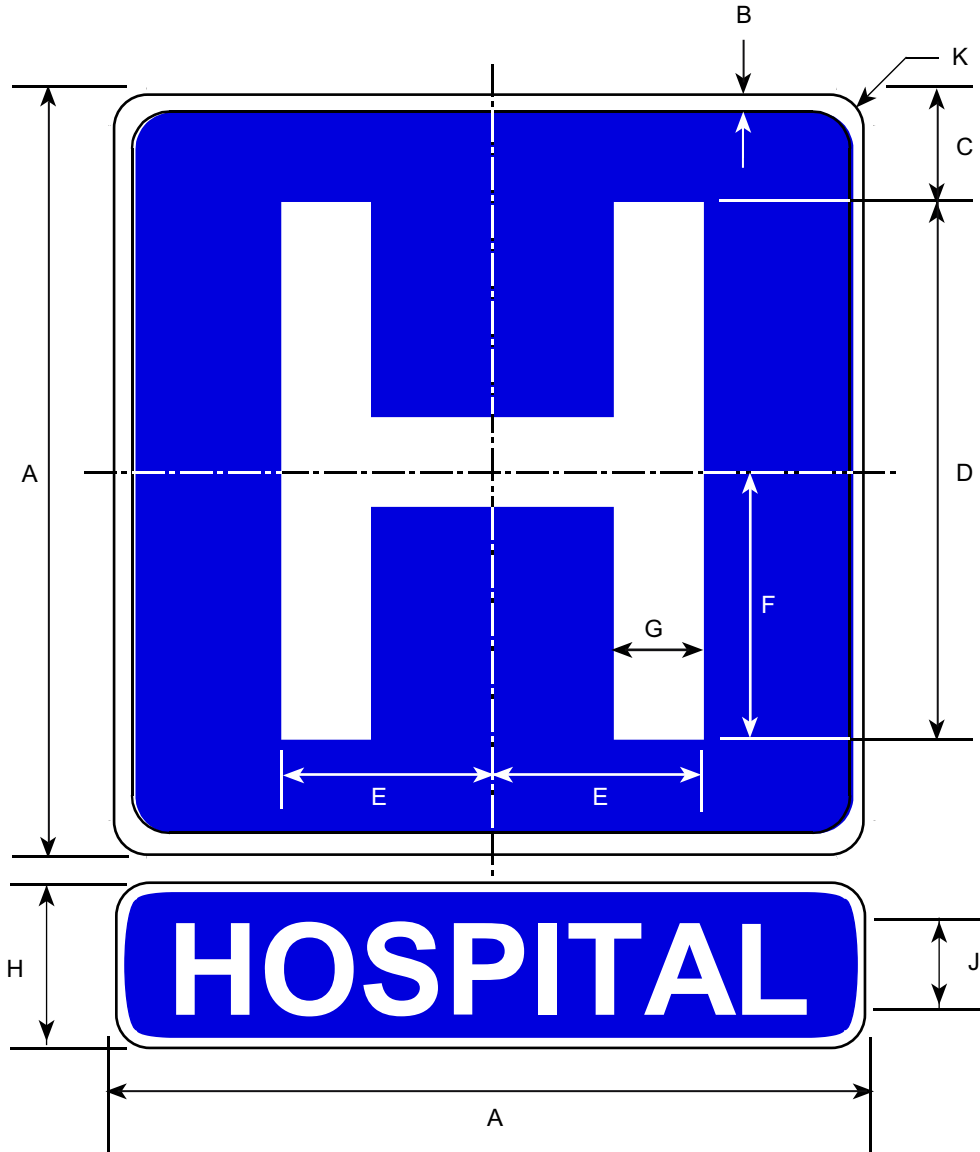

Border and Legend: White
Background: Blue

Make symbol proportional to graphic shown

Road Class	Dimensions (inches)									
	A	B	C	D	E	F	G	H	J	K
Conv/Min	24	0.50	4	16	6.38	8.38	3.2	6.0	3E	1.5
Oversized	30	0.75	5	20	8.0	10.38	4.0	8.0	4D	1.88

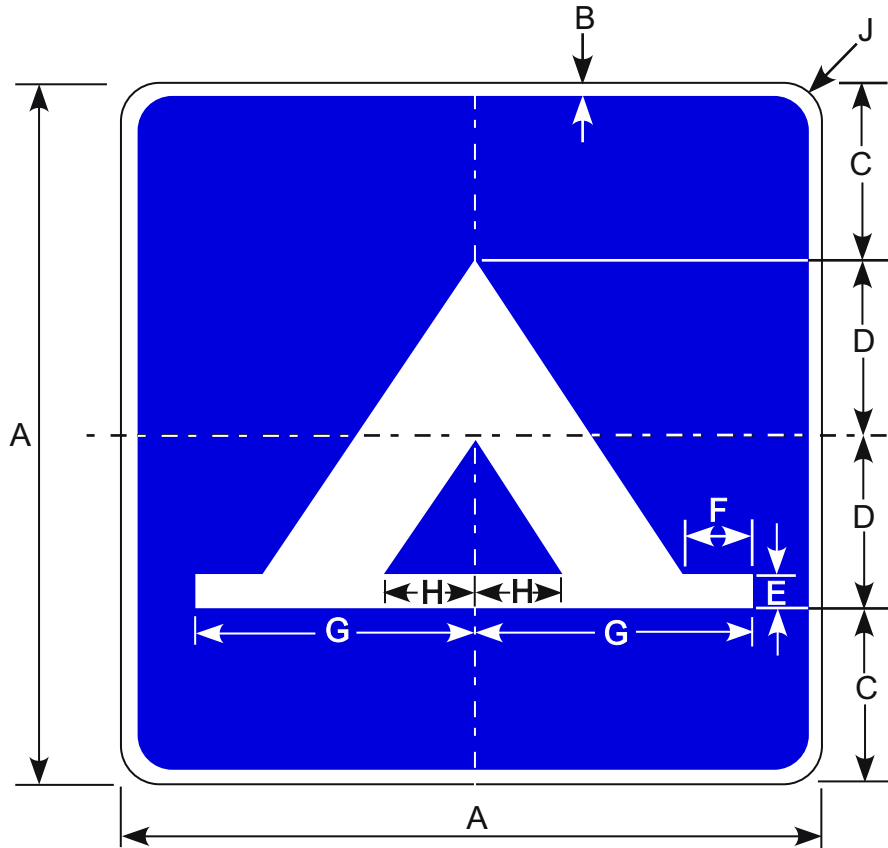

Border and Legend: White
Background: Blue

Make symbol proportional to graphic shown

Road Class	Dimensions (inches)								
	A	B	C	D	E	F	G	H	J
Conv/Min	24	0.50	6.0	6.0	1.13	2.25	9.50	3.25	1.50
Oversized	30	0.75	7.5	7.5	1.44	2.81	11.88	4.06	1.88

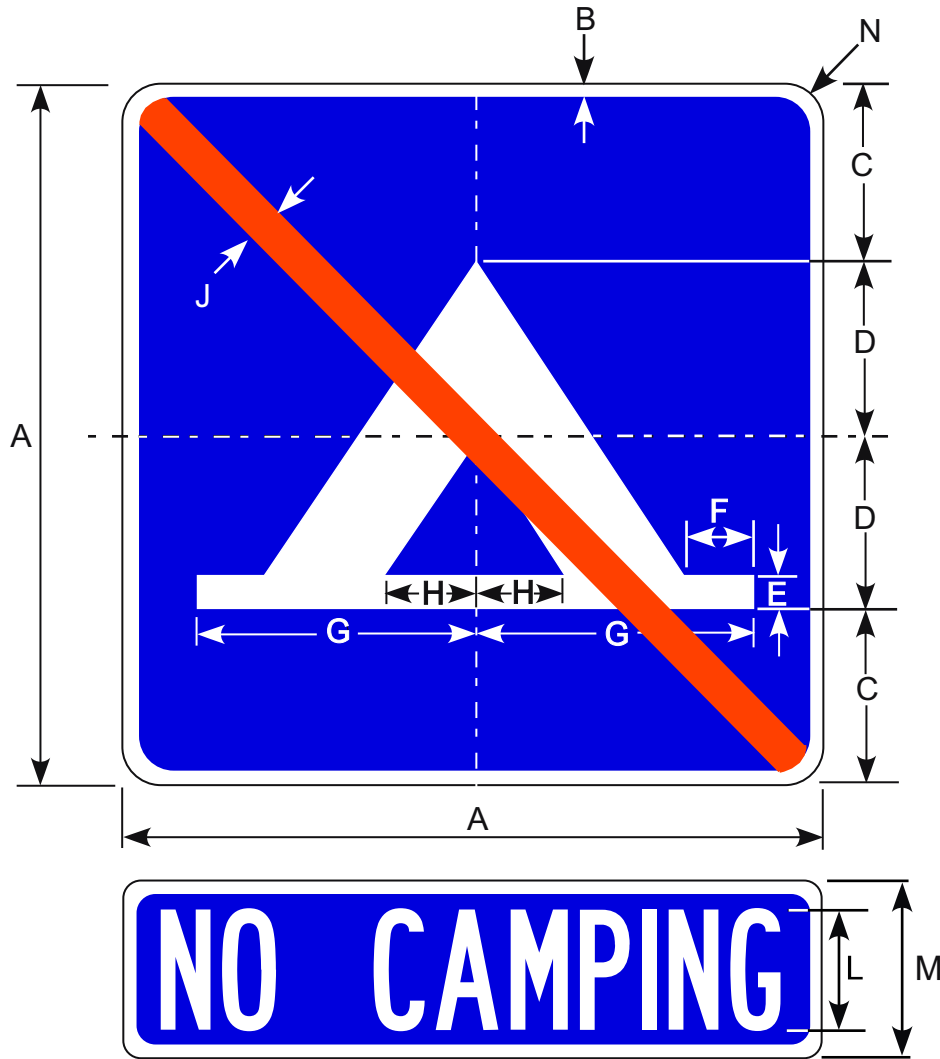

Border and Legend: White
 Background: Blue
 Cross Stripe: Red

Prior to the 2002 publication of this manual, this sign was numbered D9-3B.

Make symbol proportional to graphic shown
 Educational plaque optional.

Road Class	Dimensions (inches)											
	A	B	C	D	E	F	G	H	J	L	M	N
Con/Min	24	0.50	6.0	6.0	1.13	2.25	9.50	3.25	1.25	4B	6	1.50
Expressway	30	0.75	7.5	7.5	1.44	2.81	11.88	4.06	1.75	4B	6	1.88

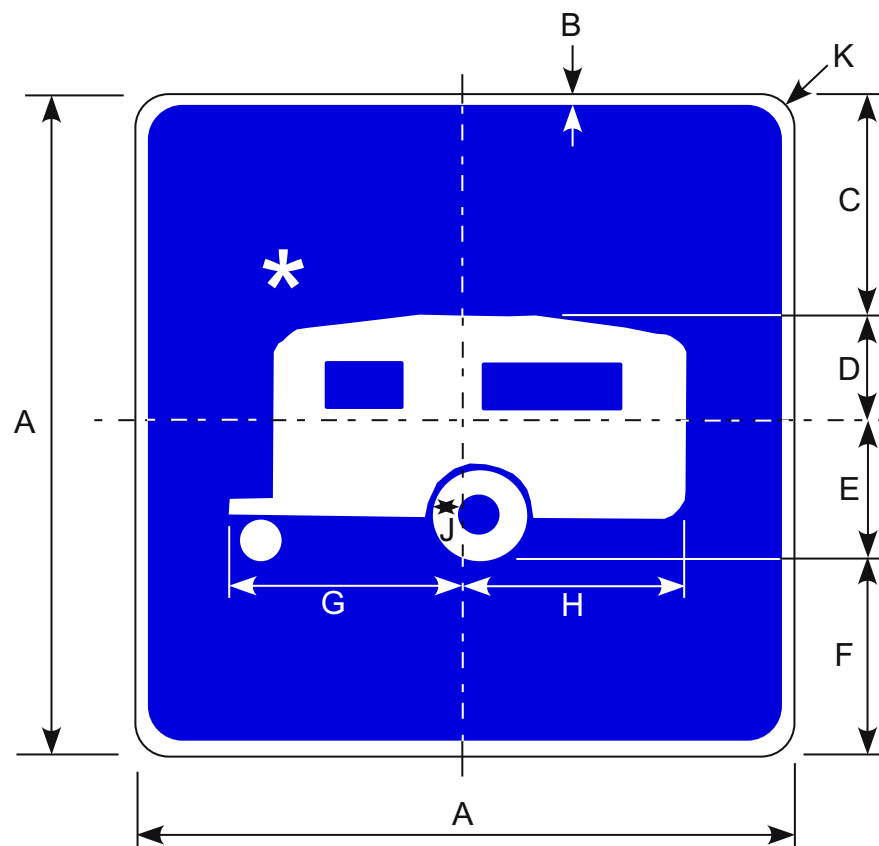

Border and Legend: White
Background: Blue

* Make symbol proportional to the graphic shown.

Prior to the 2002 publication of this manual, this sign was numbered D9-3A.

Road Class	Dimensions (inches)									
	A	B	C	D	E	F	G	H	J	K
Conv/Min	24	0.50	8	4	5.00	7.00	8.75	8.25	1.75	1.50
Special	30	0.75	10	5	6.25	8.75	10.94	10.32	2.19	1.88

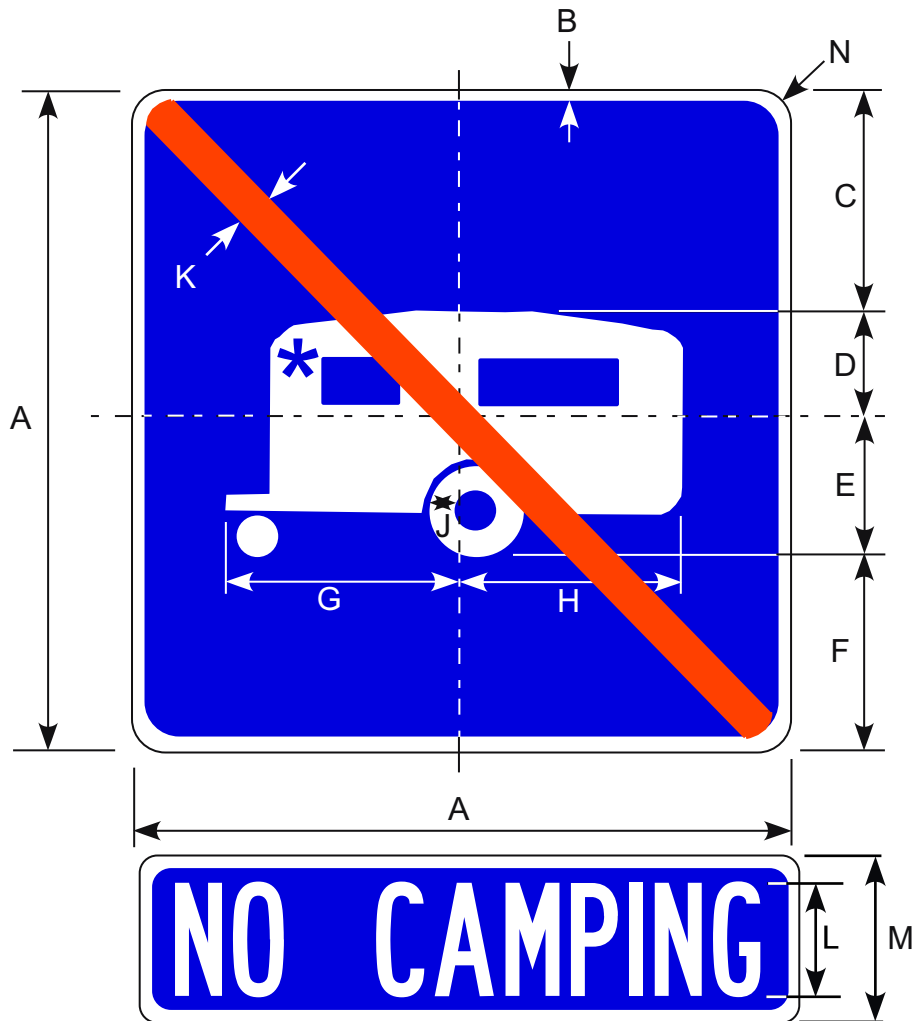

Border and Legend: White
 Background: Blue
 Cross Stripe: Red

* Make symbol proportional to graphic shown.

Prior to the 2002 publication of this manual, this sign was numbered D9-3C.

Educational plaque optional.

Road Class	Dimensions (inches)												
	A	B	C	D	E	F	G	H	J	K	L	M	N
Conv/Min	24	0.50	8	4	5.00	7.00	8.75	8.25	1.75	1.25	4B	6	1.50
Expressway	30	0.75	10	5	6.25	8.75	10.94	10.31	2.19	1.75	4B	6	1.88

D9-13B

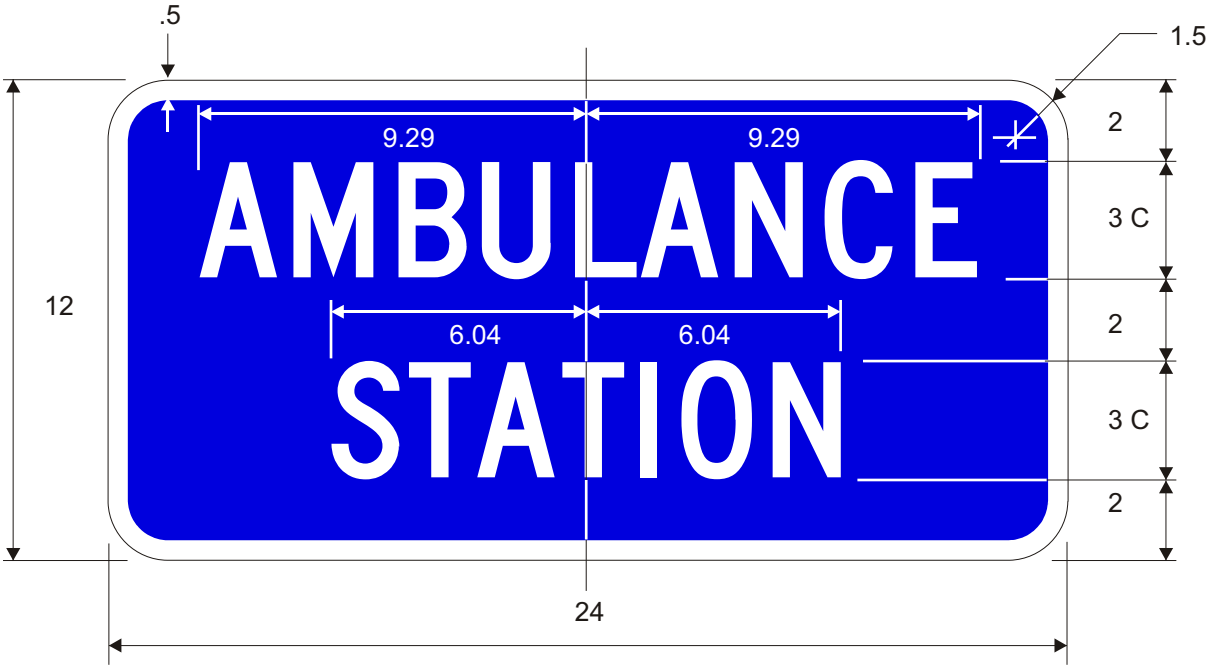

Border and Legend: White
Background: Blue

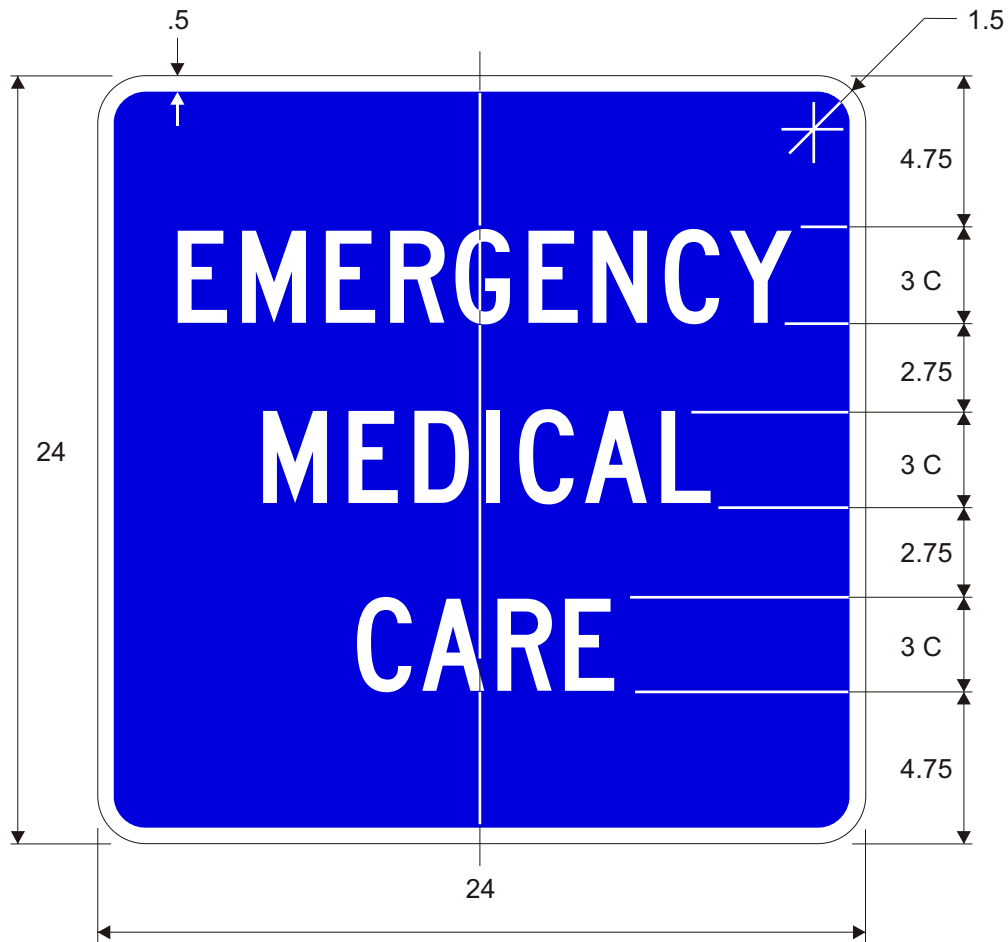

Border and Legend: White
Background: Blue

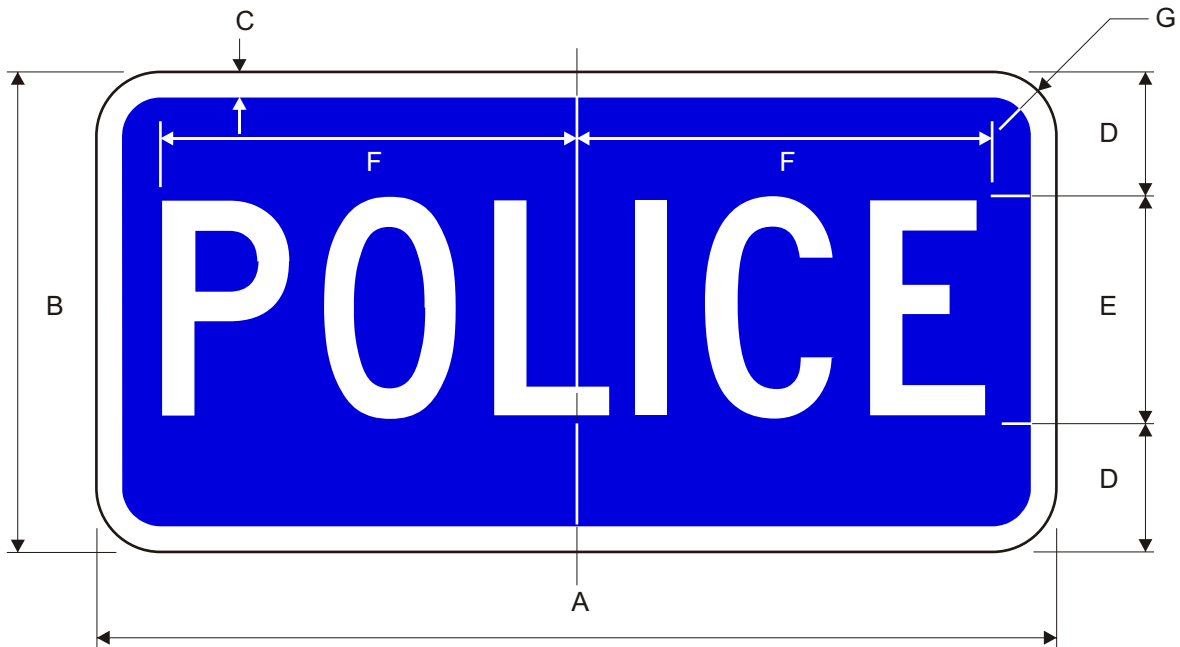

Border and Legend: White
 Background: Blue

Road Class	Dimensions (inches)						
	A	B	C	D	E	F	G
Conv/Min	24	12	0.50	3.0	6C	10.38	1.5
Expy	30	15	0.50	3.5	8C	13	1.5

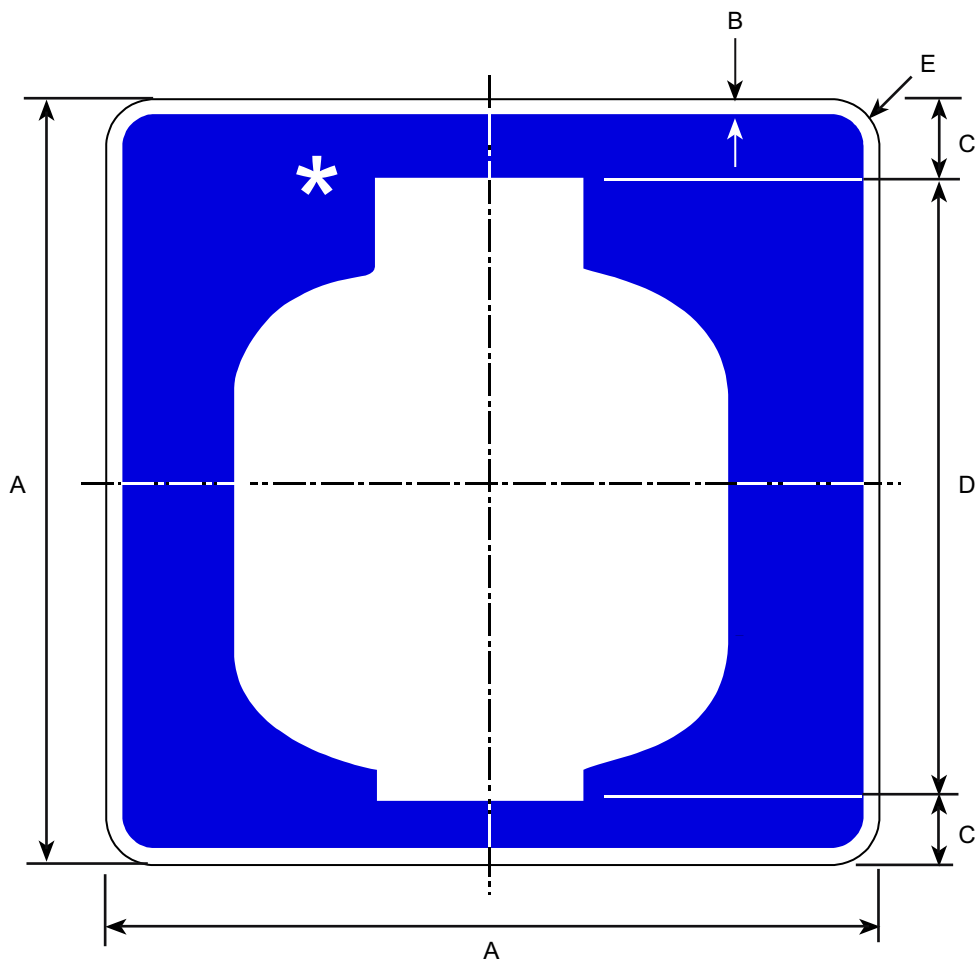

Border and Legend: White
Background: Blue

* Make symbol proportional to graphic shown

Road Class	Dimensions (inches)				
	A	B	C	D	E
Conventional	24	0.50	2.0	20	1.50
Oversized	30	0.75	2.5	25	1.88

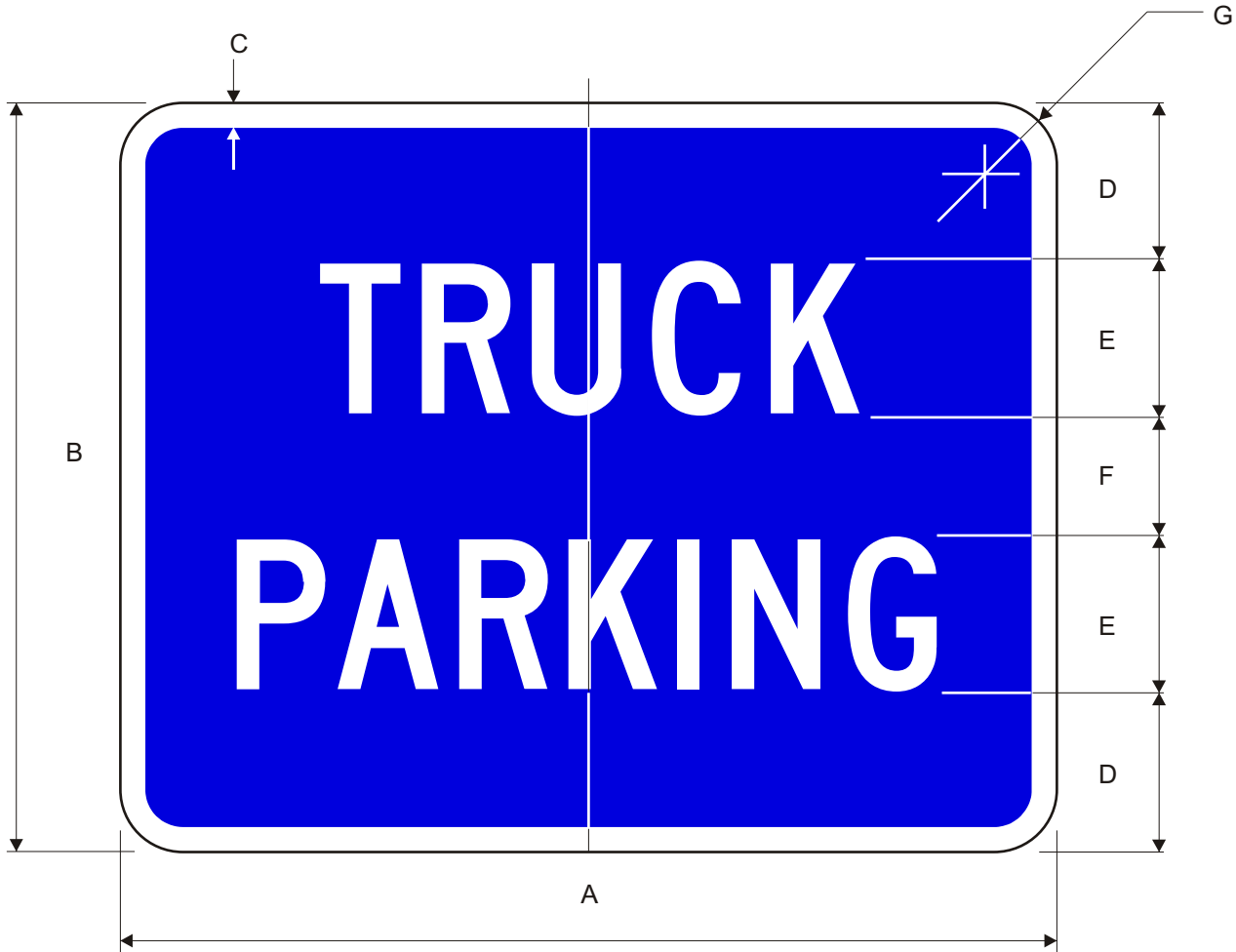

Border and Legend: White
 Background: Blue

Road Class	Dimensions (inches)						
	A	B	C	D	E	F	G
Conv/Min	24	18	0.50	3.5	4C	3.0	1.5
Expy	30	24	0.75	5.13	5C	3.75	1.88

D9-18 D9-18A

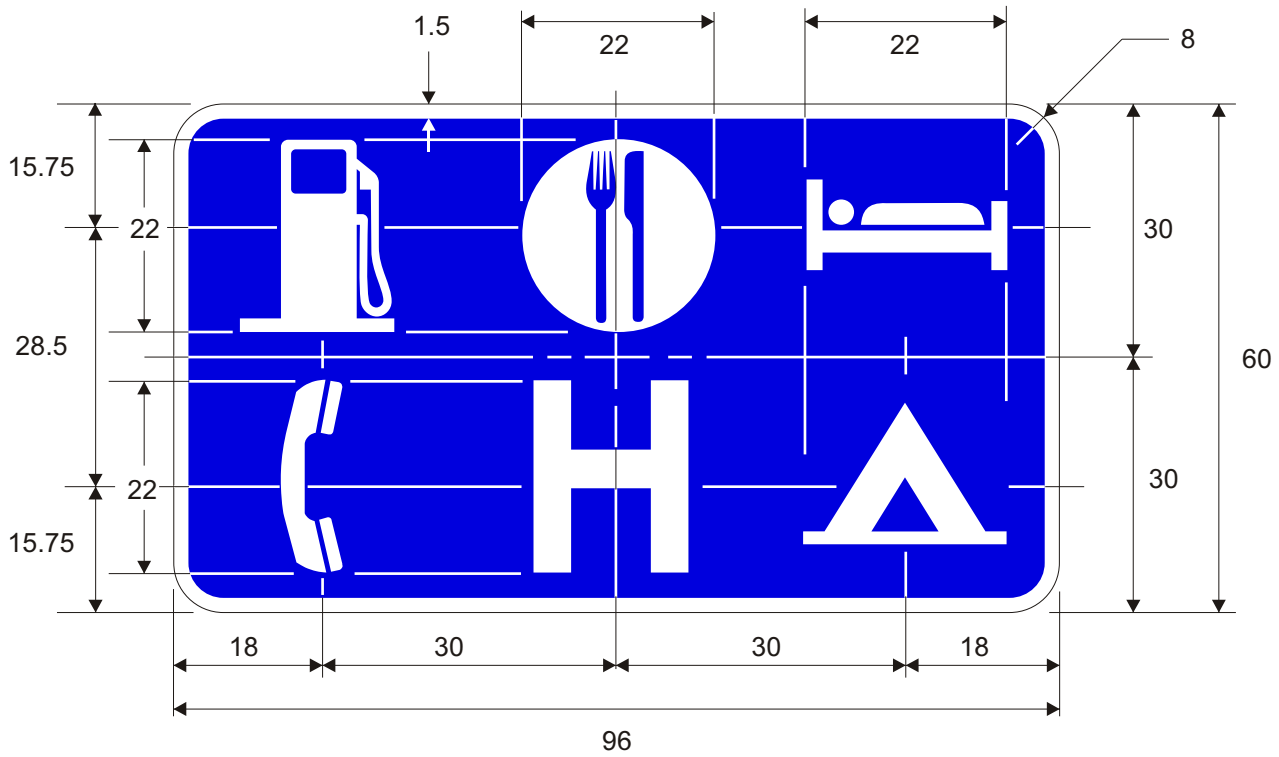

D9-18

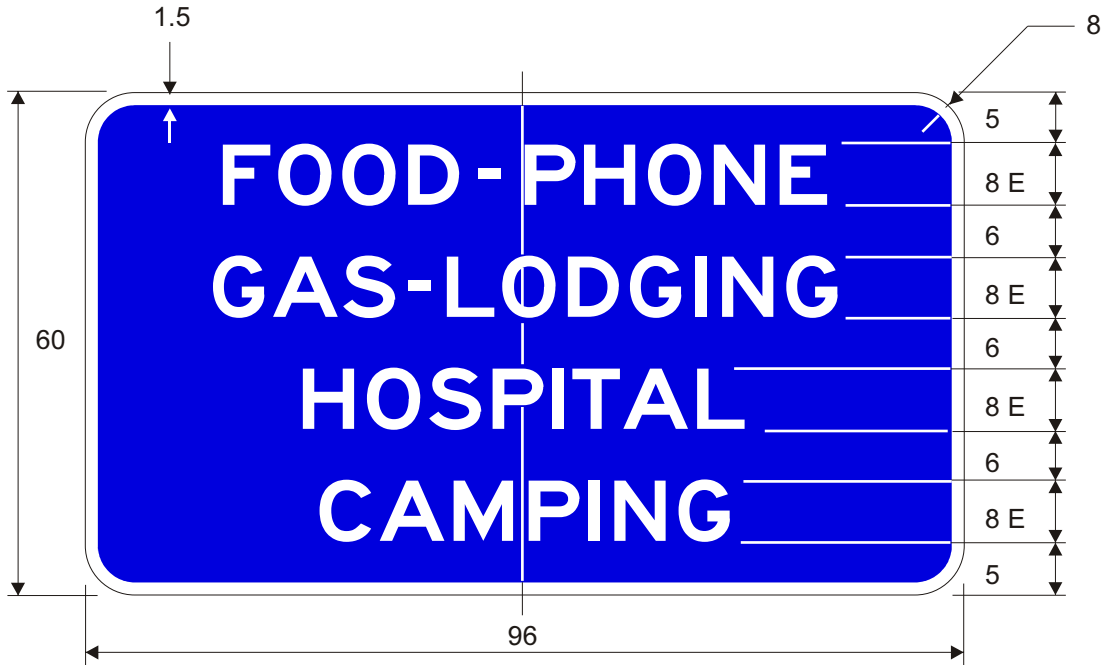

D9-18A

Border and Legend: White
Background: Blue

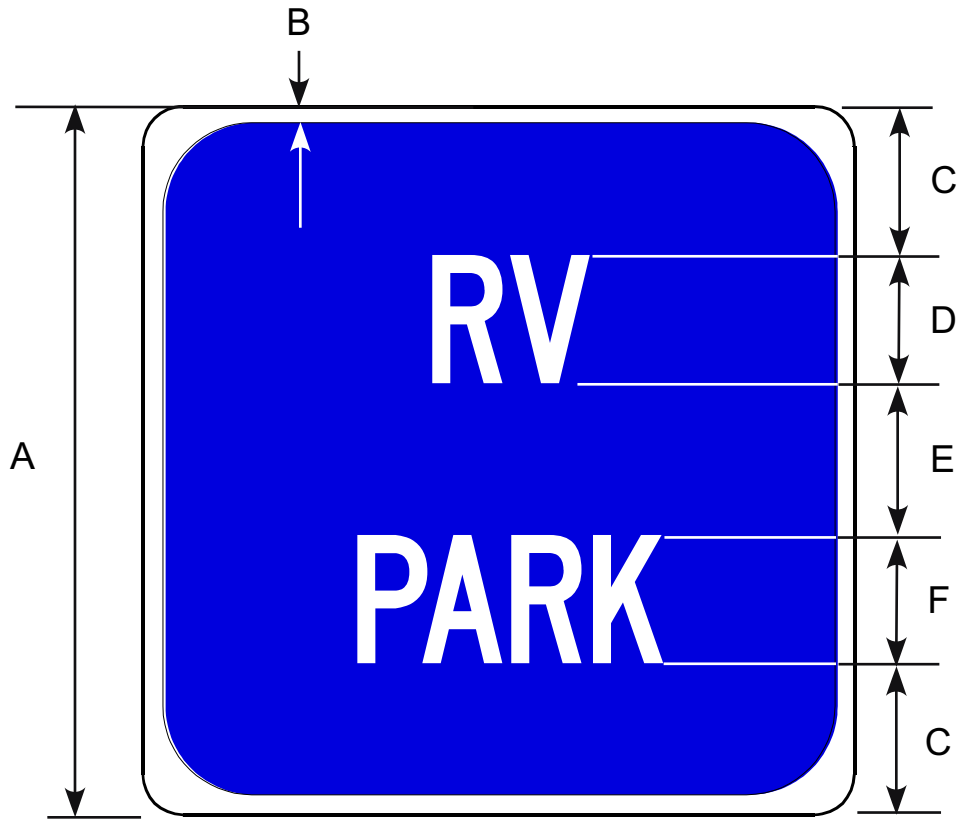

Border and Legend: White
Background: Blue

Road Class	Dimensions (inches)					
	A	B	C	D	E	F
Conv/Min	24	0.50	5.0	5E	4	5D
Expressway	30	0.75	3.5	7E	3	7D

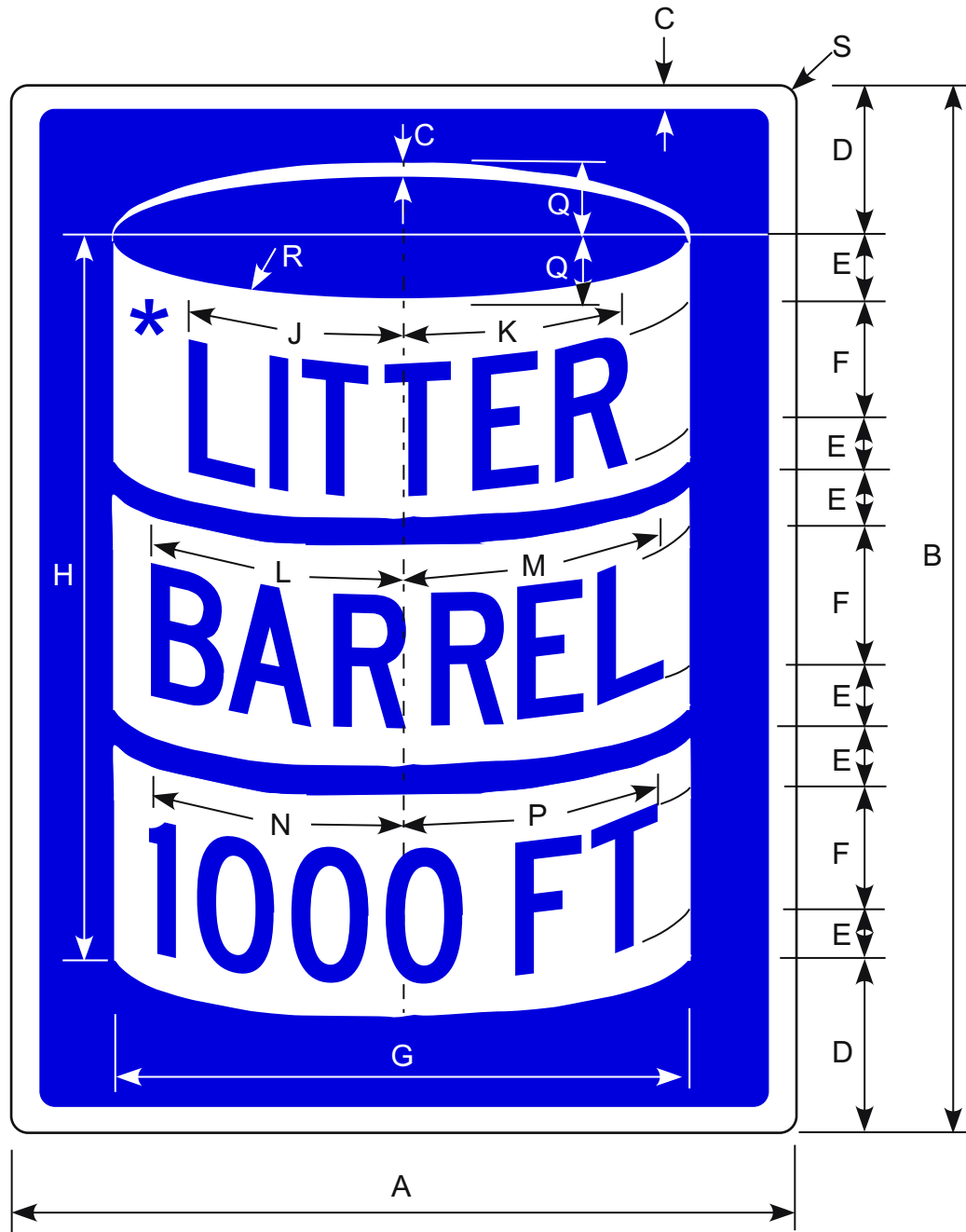

Border and Legend: White
Background: Blue

* Make symbol proportional to graphic shown.

Prior to the 2002 publication of this manual, this sign was numbered D9-4.

Road Class	Dimensions (inches)																
	A	B	C	D	E	F	G	H	J	K	L	M	N	P	Q	R	S
Conv/Mn	24	30	0.63	4.5	1.5	4C	18	21	6.63	7.0	8.25	8.5	7.5	8.0	2.0	17	1.5
Oversized	36	48	1.0	9.0	2.0	6C	24	30	10	10.5	12.38	12.75	11	11.5	3.0	17	2.25

D9-104

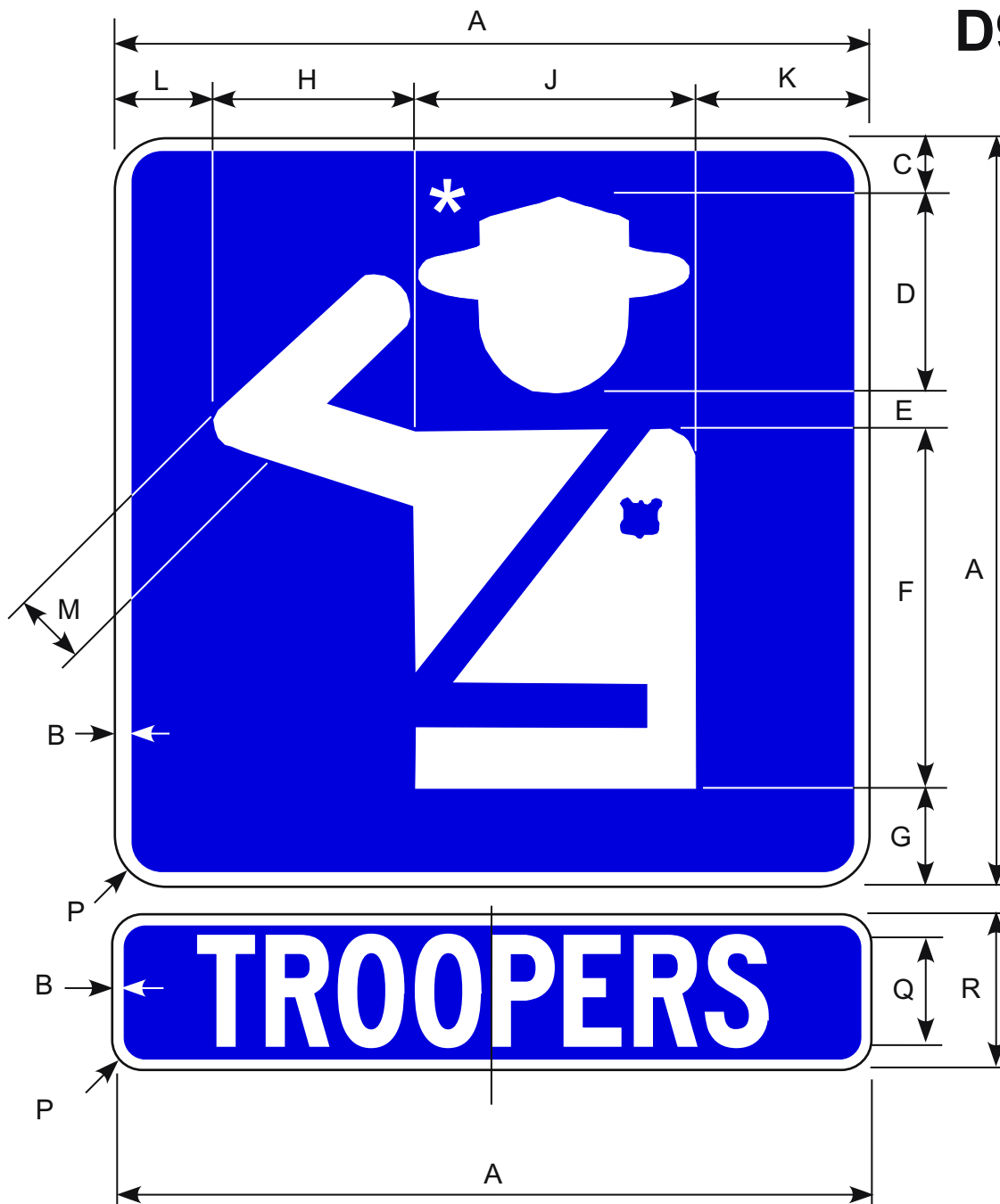

Border and Legend: White
Background: Blue

* Make symbol proportional to graphic shown.

Prior to the 2002 publication of this manual, this sign was numbered D9-15.

Educational plaque optional.

Road Class	Dimensions (inches)															
	A	B	C	D	E	F	G	H	J	K	L	M	P	Q	R	
Conv/Mn	24	0.50	1.81	6.44	1.06	11.63	3.06	6.38	9.0	5.0	3.63	2.25	1.5	4B	6.0	
Oversized	30	0.75	2.25	8.0	1.38	14.5	3.88	8.0	11.25	6.75	4.0	2.75	1.88	4C	6.0	

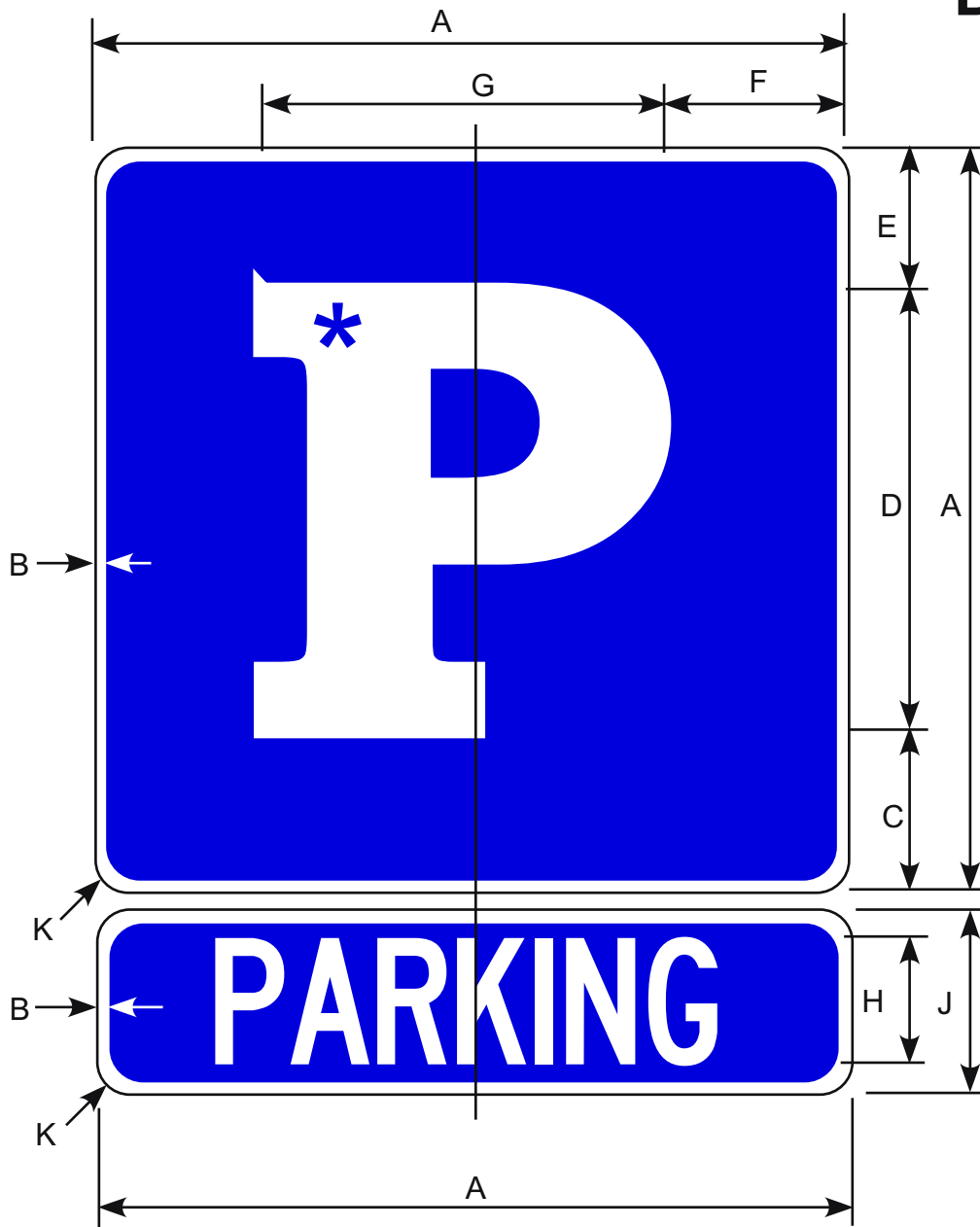

Border and Legend: White
Background: Blue

* Make symbol proportional to graphic shown

Prior to the 2002 publication of this manual, this sign was numbered D9-14.

Educational plaque optional.

Road Class	Dimensions (inches)									
	A	B	C	D	E	F	G	H	J	K
Conv/Min	24	0.50	4.63	15.56	3.81	4.94	14.13	4B	6.0	1.5
Oversized	30	0.75	5.81	19.44	4.75	6.0	18	4C	6.0	1.88

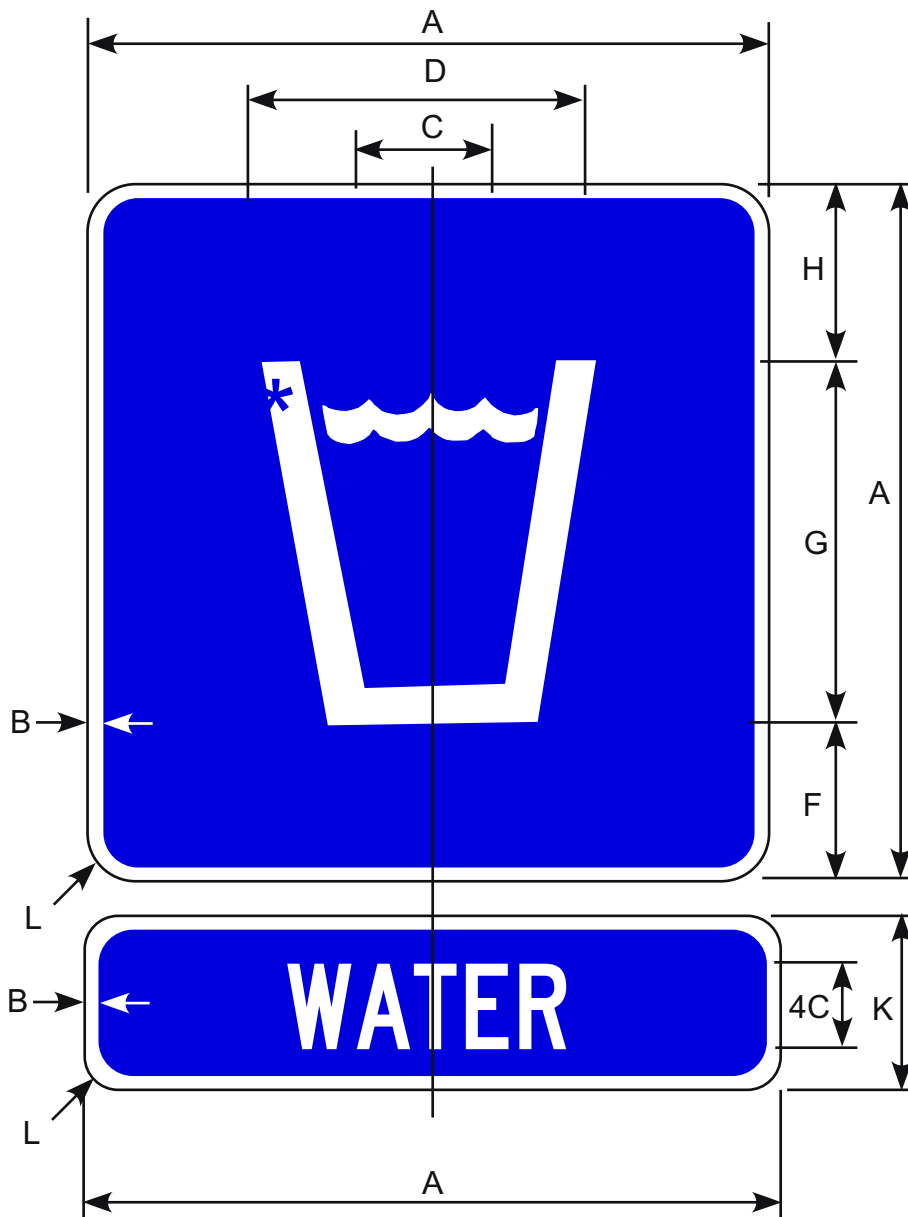

Border and Legend: White
Background: Blue

* Make symbol proportional to graphic shown.

Prior to the 2002 publication of this manual, this sign was numbered D9-13.

Educational plaque optional.

Road Class	Dimensions (inches)									
	A	B	C	D	F	G	H	J	K	L
Conv/Min	24	0.50	7.38	11.69	5.25	12.63	6.12	4B	6.0	1.5
Oversized	30	0.75	9.25	14.63	6.56	15.75	7.69	4C	6.0	1.88

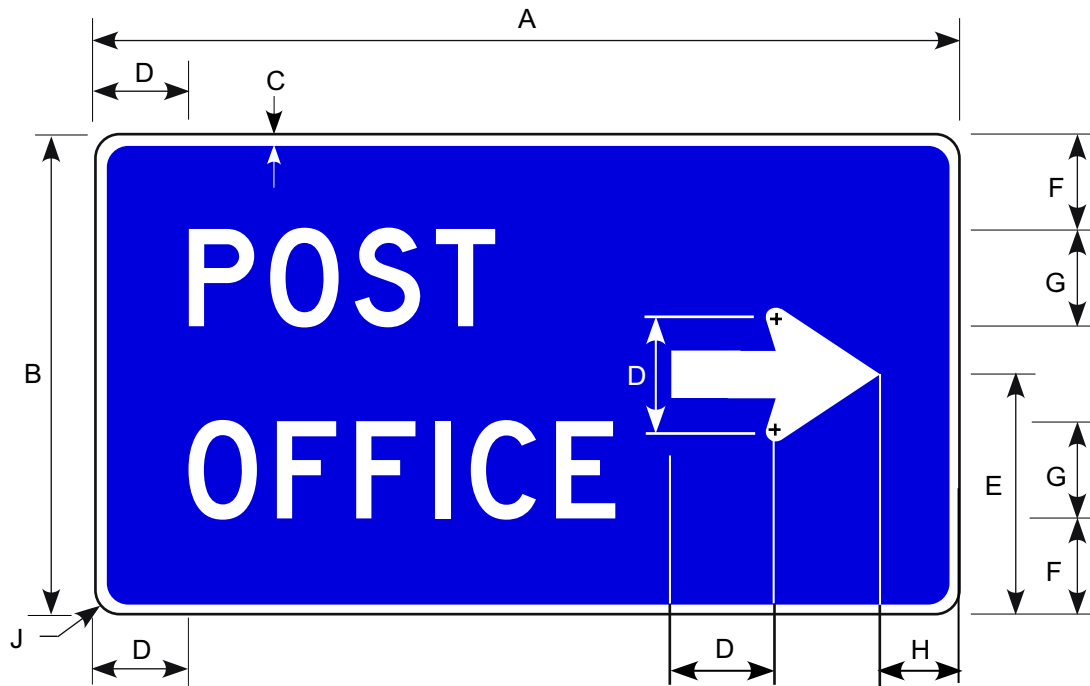

Border and Legend: White
Background: Blue

See Appendix B-1 for Standard Arrow Details.

Prior to 2002 publication of this manual,
this sign was numbered D9-19.

Road Class	Dimensions (inches)								
	A	B	C	D	E	F	G	H	J
Minimum	36	24	0.63	4.0	12	6.0	4D	2.75	1.5
Conventional	54	30	0.75	6.0	15	6.0	6D	4.88	1.88
Expressway	72	36	0.88	8.0	18	6.0	8D	6.88	2.25
Oversized	90	48	1.25	10	24	9.0	10D	8.88	3.0



Border and Legend: White
Background: Blue

Prior to 2001 publication of this manual,
this sign was numbered D9-19C.

Road Class	Dimensions (inches)							
	A	B	C	D	E	F	G	H
Minimum	48	24	0.63	5.75	6.0	4D	4.0	1.5
Conventional	66	30	0.75	6.0	6.0	6D	6.0	1.88
Expressway	90	36	0.88	8.5	6.0	8D	8.0	2.25
Oversized	114	48	1.25	11.5	9.0	10D	10	3.0

D9-201

D9-202

D9-203



D9-201



D9-202



D9-203

Border and Legend: White
Background: Blue

Road Class	Letter Size	Dimensions (Inches)			Border Width
		D9-201	D9-202	D9-203	
Conventional	8E	120 X 84	120 X 48	96 X 48	1.5
Expwy/Fwy	10E	144 X 108	144 X 60	120 X 60	2.0

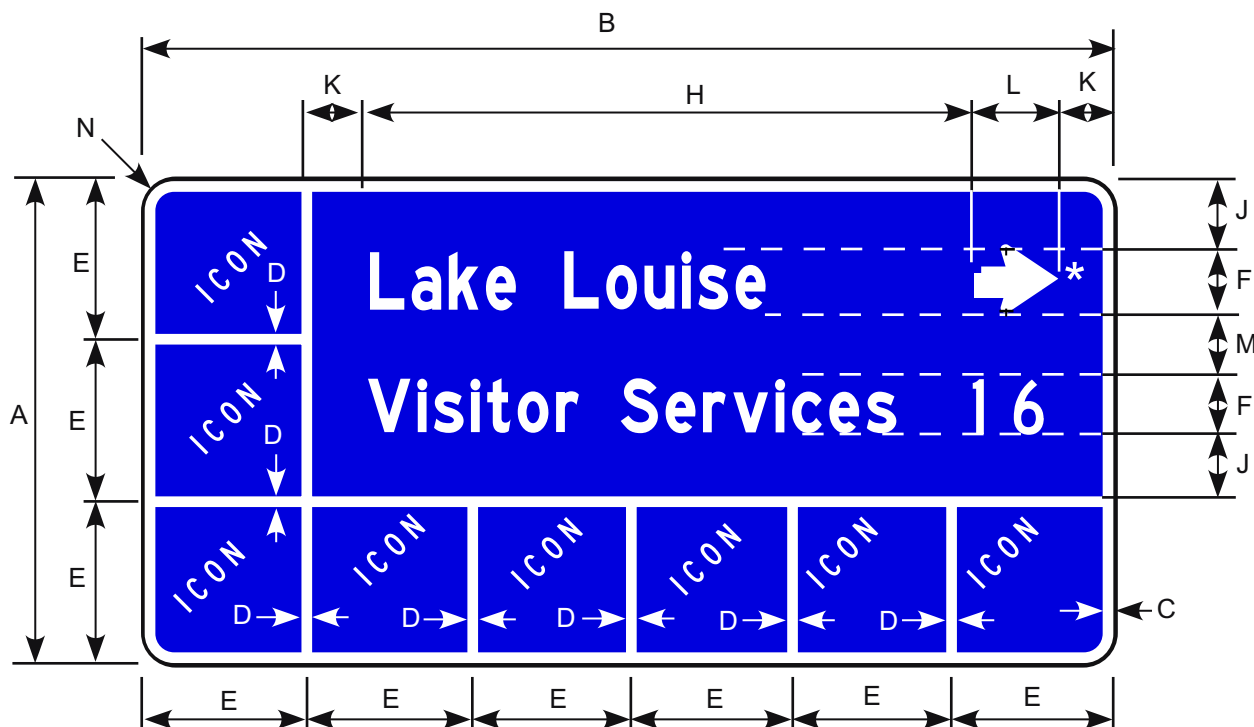

Border and Legend: White
Background: Blue

* Arrow should always be placed near the outer edge of the sign, icons should be placed on other side of sign. See Appendix B-1 for Standard Arrow Details.

Reverse sign layout for left or up arrow.

Road Class	Dimensions (inches)												
	A	B	C	D	E	F	G	H	J	K	L	M	N
Conv & Min	54	108	1.25	1	18	7C	2.0	VAR	8	5	9.75	7.00	3.38

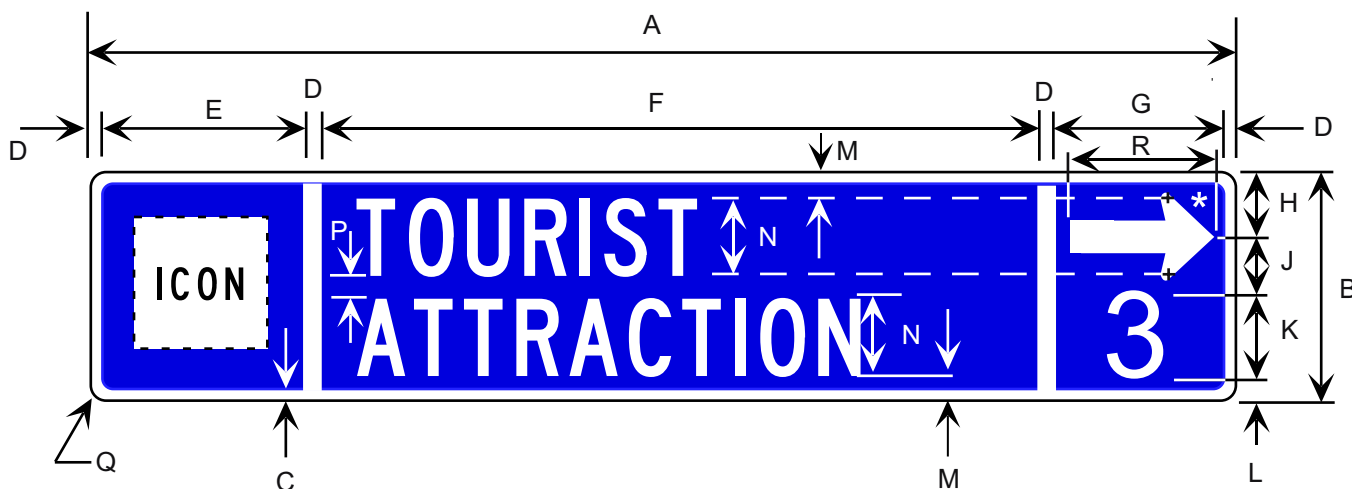

Border and Legend: White
Background: Blue

*See Appendix B-1 for Standard Arrow Details.

NOTES:

This is a Tourist Orient Directional Sign (TODS).

- 1) The length of legend on any one line shall not exceed 54 inches.
- 2) Up to three TODS panels may be placed (with a two inch vertical separation) on one set of sign supports.
- 3) When arrows on multiple panels point in different directions, the panels shall be arranged as follows starting from the top:
Arrow Up, Arrow Left, Arrow Right.
- 4) When arrows on multiple panels point in the same direction, the top panel shall show the nearest business and the bottom panel shall show the most distant.
- 5) * 6" series C letters may be used when the legend will not fit with series D.
- 6) If attraction is adjacent to roadway, delete mileage and center arrow in space.

Road Class	Dimensions (inches)																
	A	B	C	D	E	F	G	H	J	K	L	M	N	P	Q	R	
Conv & Min	90	18	0.75	0.75	16	60	11	5.38	4.63	6D*	2	2	6D	2	1.5	9	

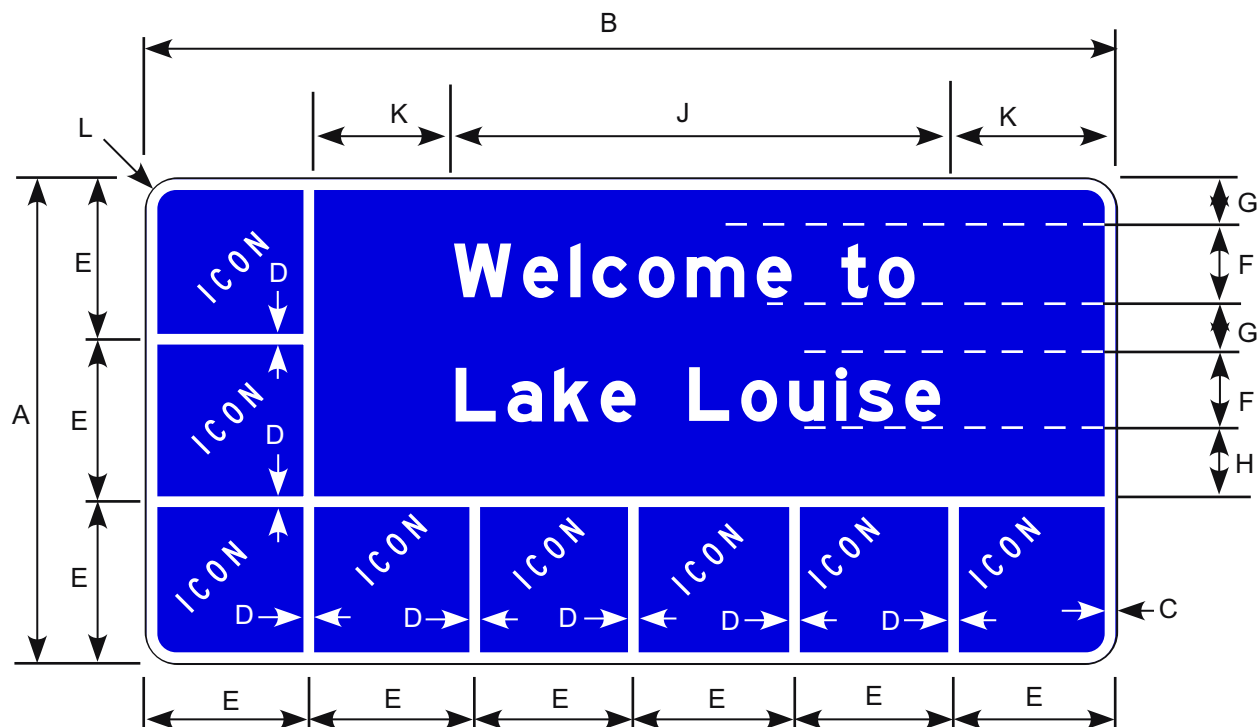

Border and Legend: White
Background: Blue

Road Class	Dimensions (inches)										
	A	B	C	D	E	F	G	H	J	K	L
Conv&	54	108	1.25	1	18	10C	5	6.0	VAR	VAR	3.38

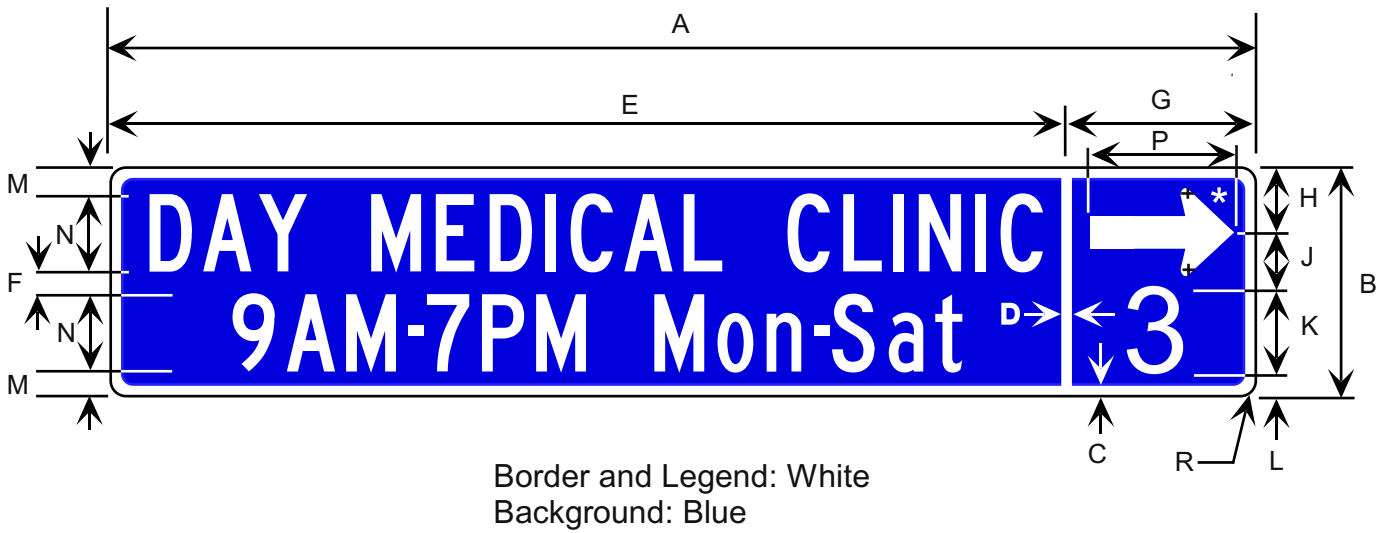

*See Appendix B-1 for Standard Arrow Details.

Road Class	Dimensions (inches)															
	A	B	C	D	E	F	G	H	J	K	L	M	N	P	R	
Conv & Min	90	18	0.75	0.75	78	2	12	5.37	4.63	6D	2	2	6C	9	1.5	

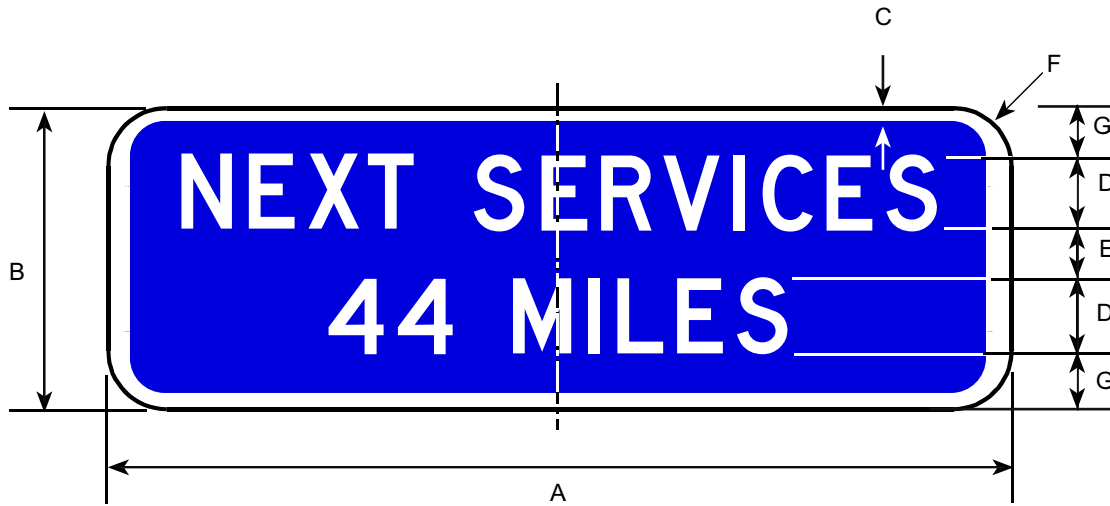

Border and Legend: White
 Background: Blue

Road Class	Dimensions (inches)						
	A	B	C	D	E	F	G
Conv/Min	72	24	1.25	6D	3.0	4	4.50
Oversized	96	36	1.50	8D	5.5	6	7.25

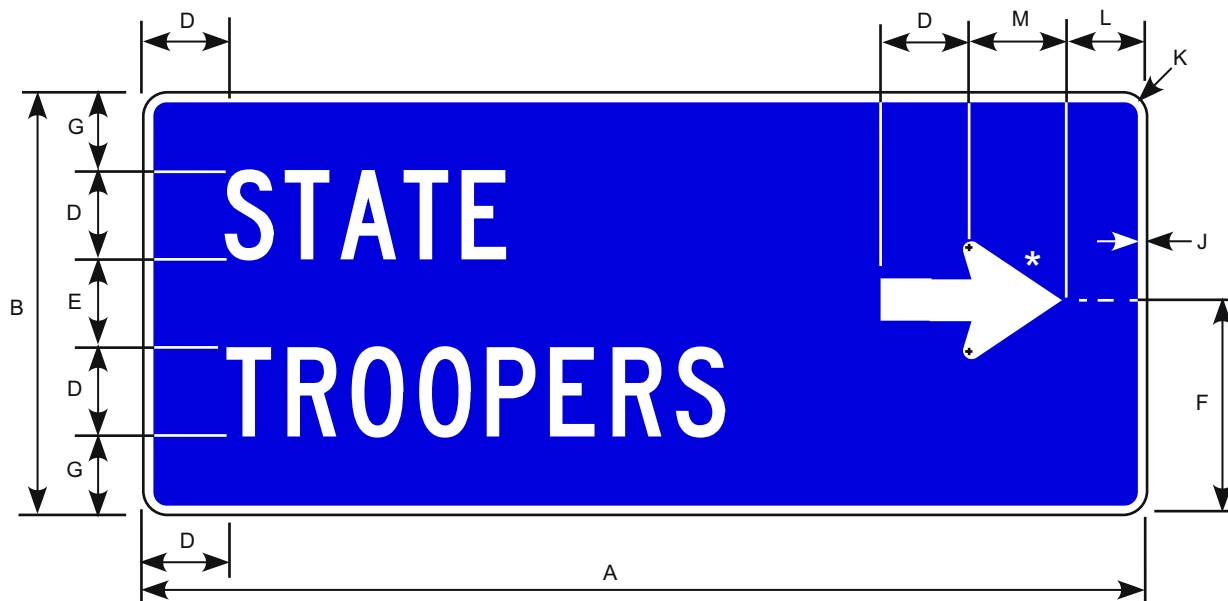

Border and Legend: White
Background: Blue

Prior to the 2002 publication of this manual,
this sign was numbered D9-18.

*See Appendix B-1 for Standard Arrow Details.

Road Class	Dimensions (inches)								
	A	B	D	E	F	G	J	K	L
Minimum	48	24	4E	4.0	12	6.0	0.63	1.5	2.75
Conventional	66	30	6E	6.0	15	6.0	0.75	1.88	4.88
Expressway	90	36	8E	8.0	18	6.0	0.88	2.25	6.88
Freeway	114	48	10E	10	24	9.0	1.25	3.0	8.88

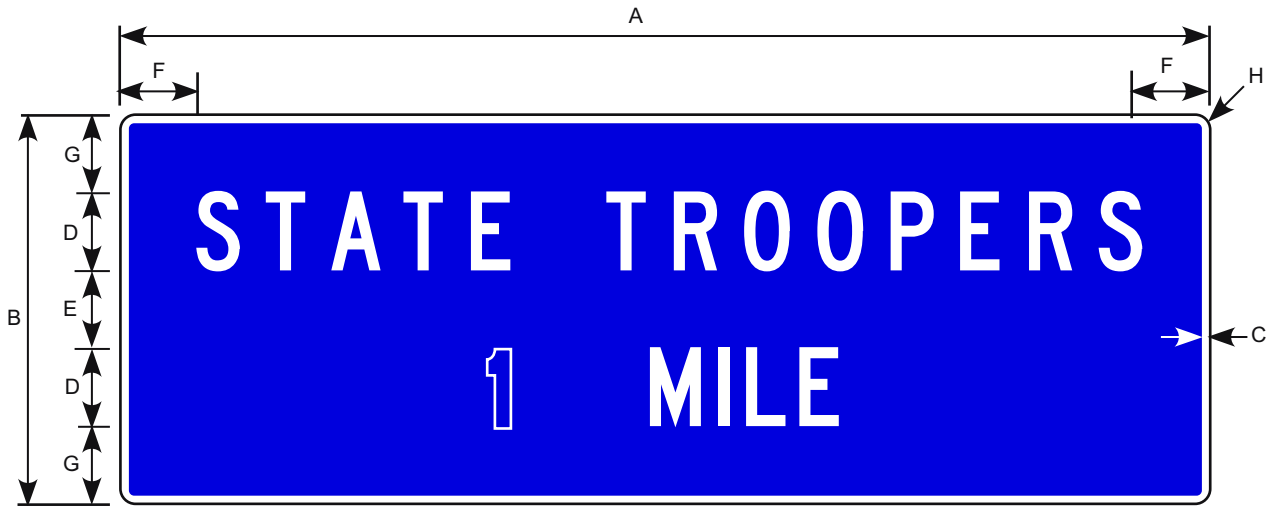

Border and Legend: White
Background: Blue

Prior to the 2002 publication of this manual,
this sign was numbered D9-18C.

Road Class	Dimensions (inches)							
	A	B	C	D	E	F	G	H
Minimum	60	24	0.63	4E	4.0	6.0	6.0	1.5
Conventional	84	30	0.75	6E	6.0	6.0	6.0	1.88
Expressway	114	36	0.88	8E	8.0	8.75	6.0	2.25
Freeway	144	48	1.25	10E	10	11.75	9.0	3.0

D9-230

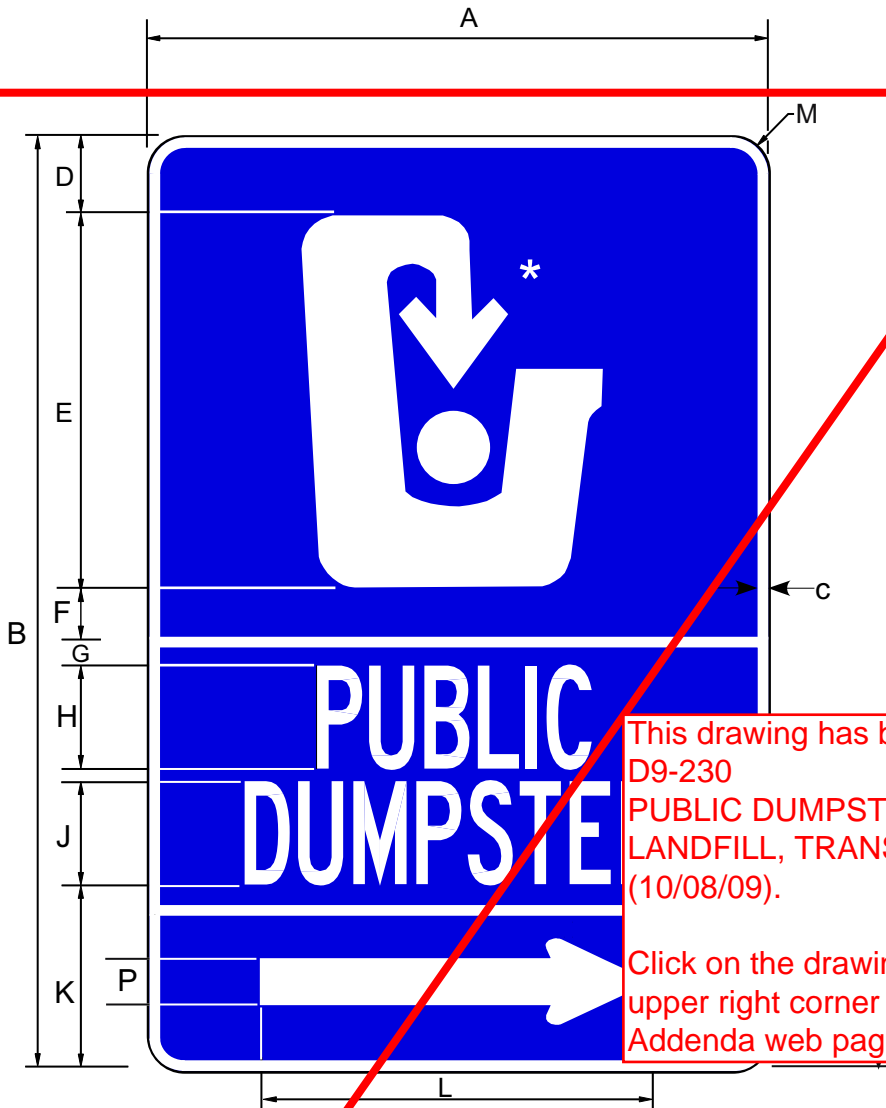

This drawing has been replaced with:
 D9-230
 PUBLIC DUMPSTER (SANITARY
 LANDFILL, TRANSFER SITE)
 (10/08/09).
 Click on the drawing number in the
 upper right corner to go to the Interim
 Addenda web page.

Border and Legend: White
 Background: Blue
 Circle in Dumpster: White

* Make symbol proportional
 to graphic shown.

** See Appendix B-1 for Standard Arrow Details.

Road Class	Dimensions (inches)													
	A	B	C	D	E	F	G	H	J	K	L	M	N	P
Conv & Min	24	36	0.63	3.12	14.38	2.0	0.5	4B	4.5	7.13	15	1.5	6.0	1.5

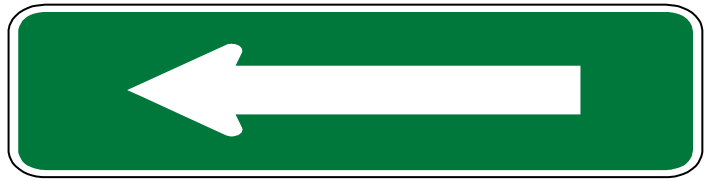
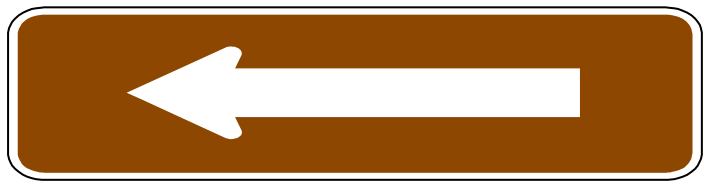
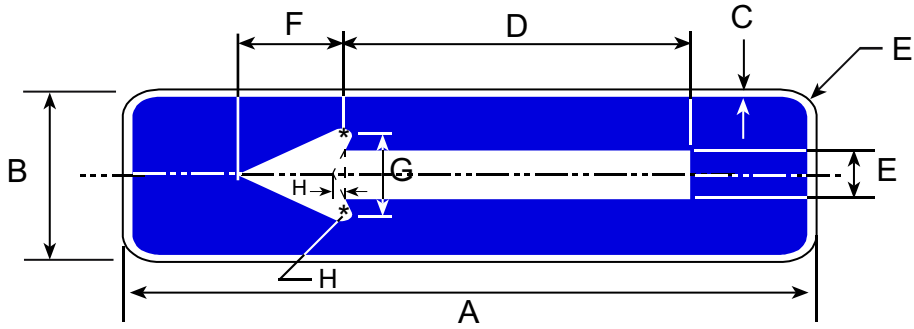

* See Appendix B-1 for Standard Arrow Details.

Border and Legend: White
 Background: Blue or Brown or Green

Road Class	Dimensions (inches)							
	A	B	C	D	E	F	G	H
Conventional	24	6.0	0.5	12	1.5	3.0	3.5	0.25

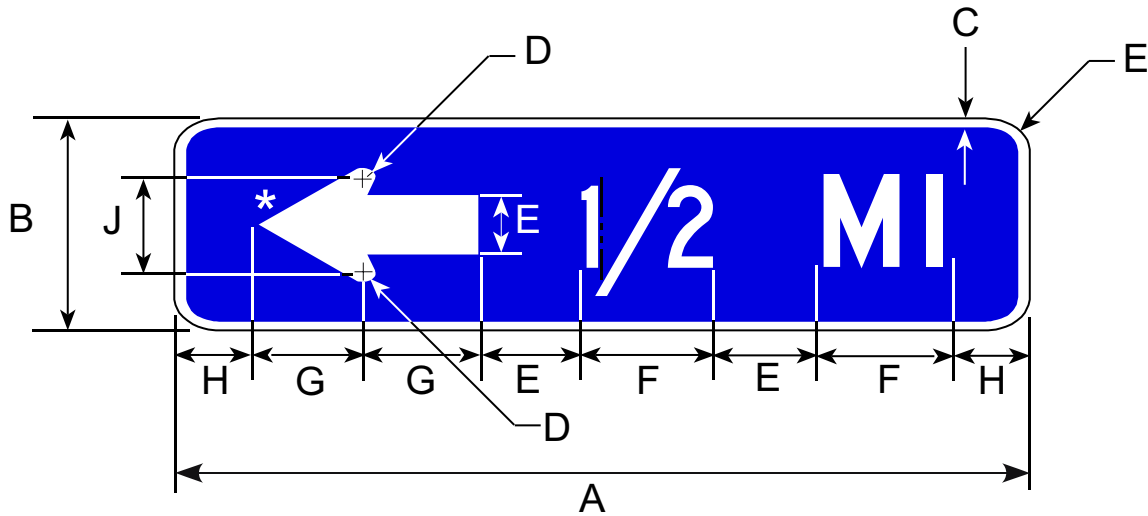

Border and Legend: White
Background: Blue or Brown

Note: Use 4" Series C for cap, 4" Series C numerals or 3" Series C fraction (shown).

* See Appendix B-1 for Standard Arrow Details.

Road Class	Dimensions (inches)								
	A	B	C	D	E	F	G	H	J
Conventional	24	6.0	0.5	0.25	2±	5.0	3.0	2.0	3.5

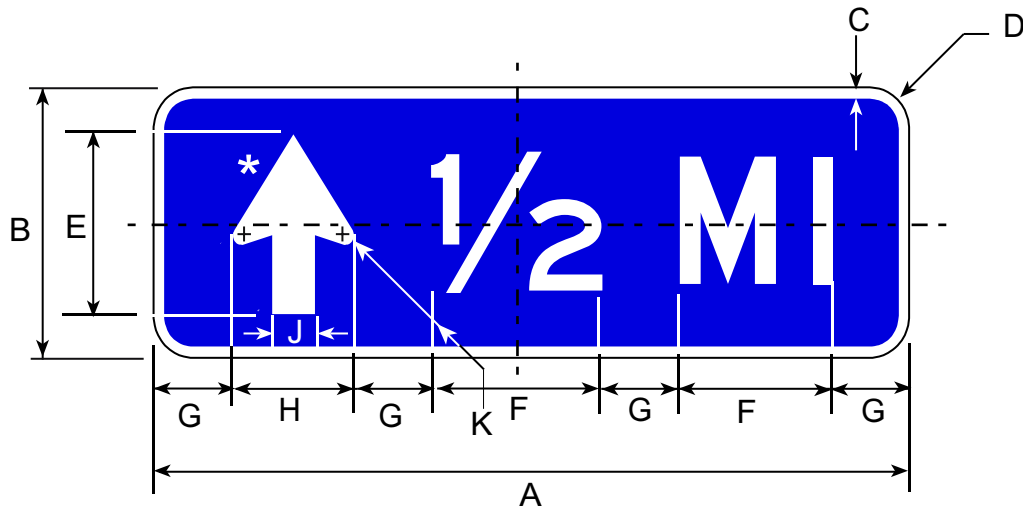

Border and Legend: White
Background: Blue or Brown

Note: Use 4" Series C for Caps, 4" Series C Numerals, or 3" Series C Fraction (shown).

* See Appendix B-1 for Standard Arrow Details.

Road Class	Dimensions (inches)									
	A	B	C	D	E	F	G	H	J	K
Conventional	24	9	0.38	1.5	6.0	5.0	2.5	4.0	1.5	0.25

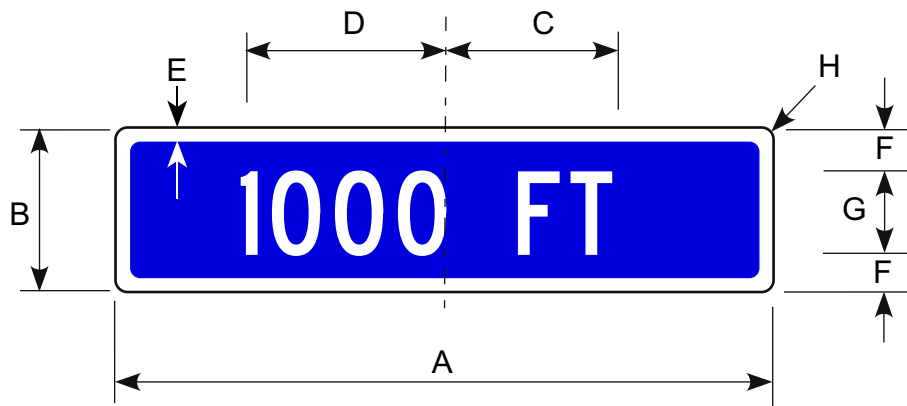

Border and Legend: White
 Background: Blue or Brown

Prior to the 2002 publication of this manual,
 this sign was numbered D9-B.

Road Class	Dimensions (inches)							
	A	B	C	D	E	F	G	H
Conv & Min	24	6	9.5	10	0.5	1	4C	1.5

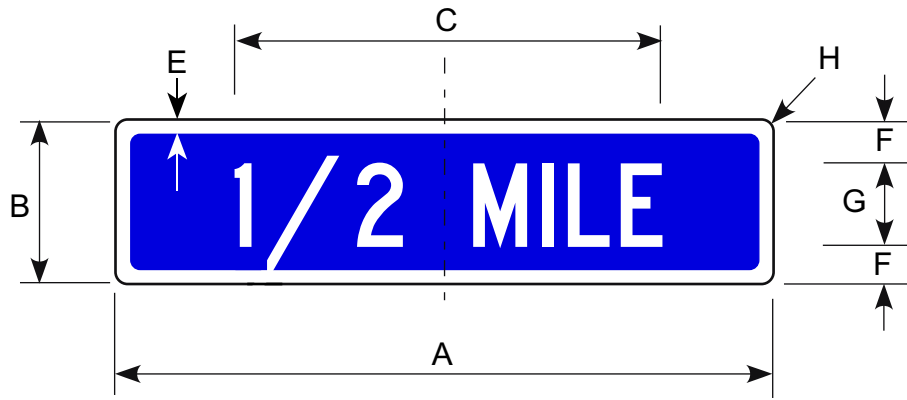

Border and Legend: White
 Background: Blue or Brown

Prior to the 2002 publication of this manual,
 this sign was numbered D9-D.

Road Class	Dimensions (inches)						
	A	B	C	E	F	G	H
Conv & Min	24	6	19.50	0.5	1	4C	1.5

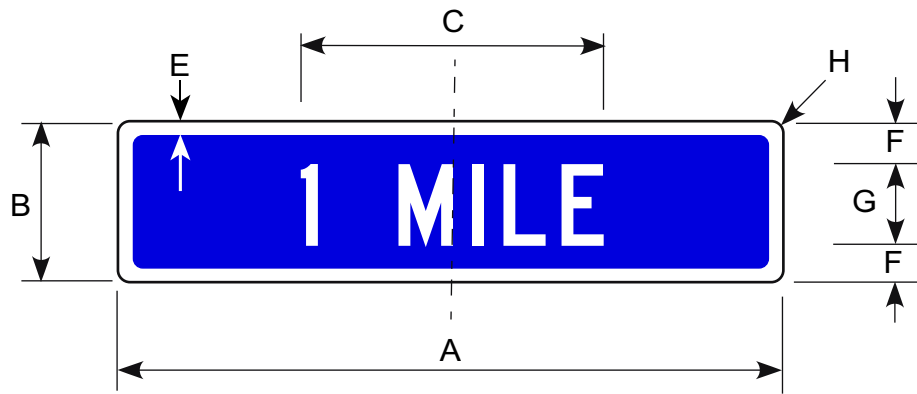

Border and Legend: White
 Background: Blue or Brown

Prior to the 2002 publication of this manual,
 this sign was numbered D9-C.

Road Class	Dimensions (inches)						
	A	B	C	E	F	G	H
Conv & min	24	6.00	13.13	0.50	1.00	4C	1.50

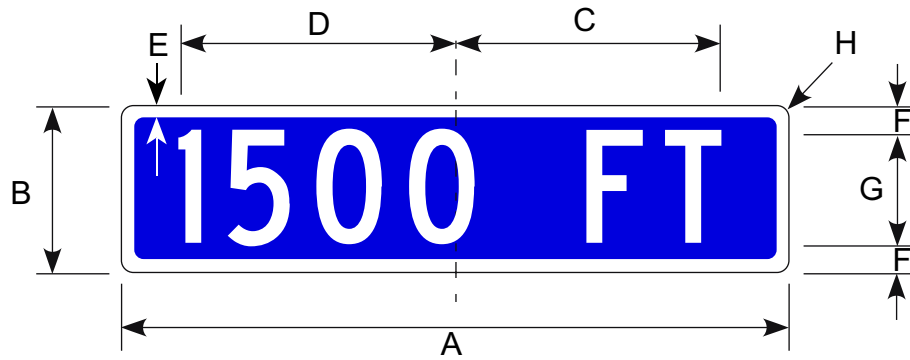

Border and Legend: White
 Background: Blue or Brown

Prior to the 2002 publication of this manual,
 this sign was numbered D9-E.

Road Class	Dimensions (inches)							
	A	B	C	D	E	F	G	H
Conv & Min	24	6	9.50	9.88	0.5	1	4C	1.5

DESTINATION SIGNS - MILE POSTS

D10-1 to D10-104A

Message on one side of sign

D10-1
D10-2
D10-3
D10-400

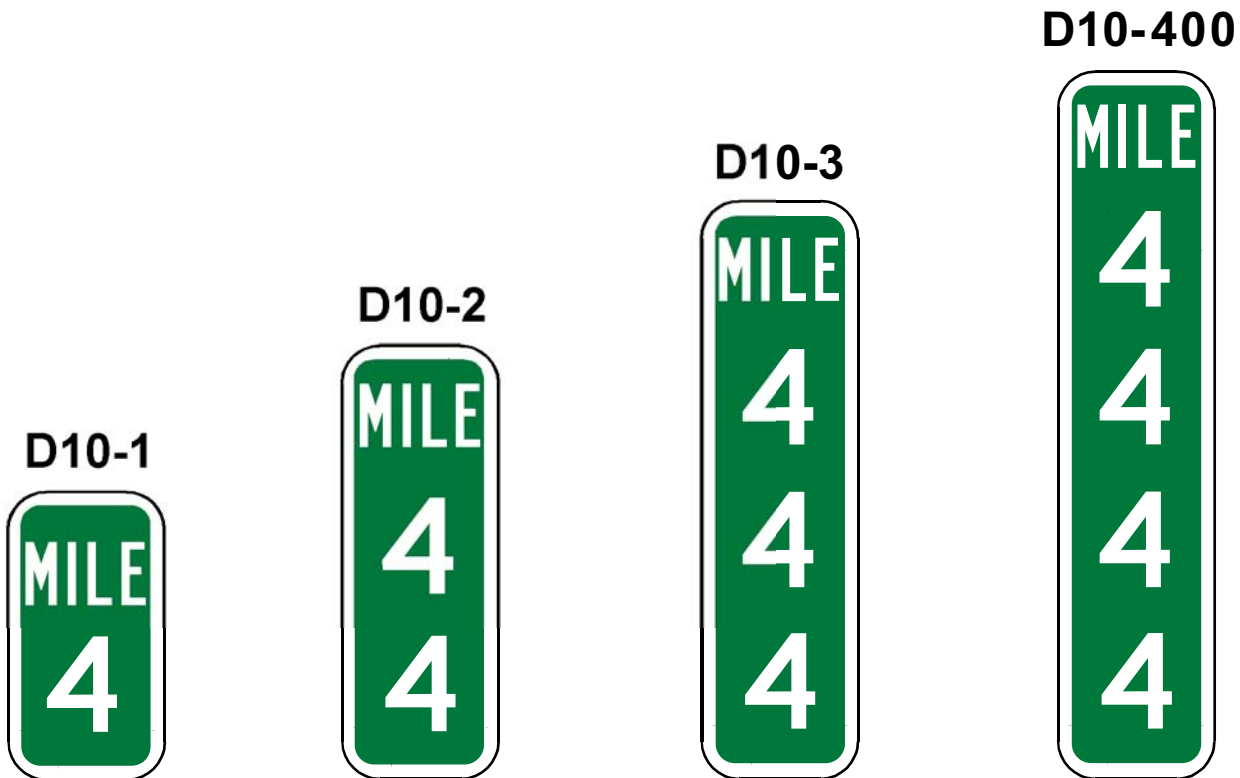

Border and Legend: White
Background: Green

Sign Number	Sign Size	Dimensions (inches)			
		Letter Size and Series	Num. Size and Series	Border Width	Corner Radius
D10-1	10 x 18	4B	6D	0.50	1.00
	12 x 24	4C	10D	0.75	1.50
D10-2	10 x 27	4B	6D	0.50	1.00
	12 x 36	4C	10D	0.75	1.50
D10-3	10 x 36	4B	6D	0.50	1.00
	12 x 48	4C	10D	0.75	1.50
D10-400	10 x 42	4B	6D	0.50	1.00
	12 x 66	4C	10D	0.75	1.50

D10-1A
D10-2A
D10-3A

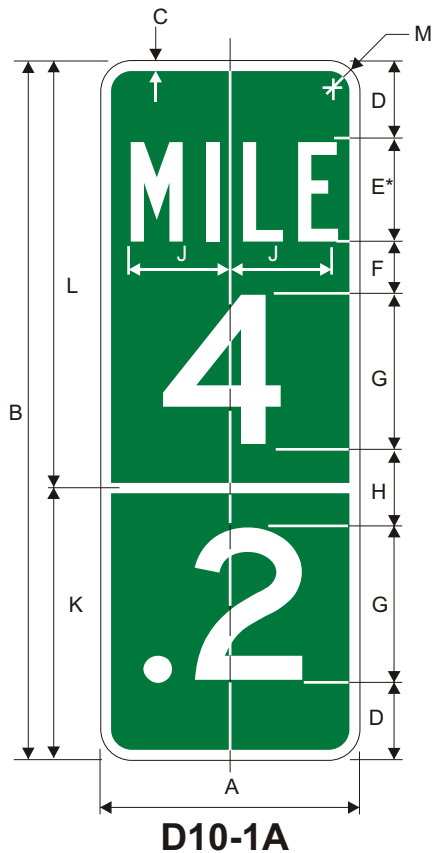

D10-1A

Road Class	Dimensions (inches)					
	A	B	C	D	E	F
Mn/Conv	10	27	0.5	3.0	4B	2.0
Expy/Fwy	12	36	0.5	3.0	4B	3.0
	G	H	J	K	L	M
6D	3.0	3.92	10.5	16.5	1.5	
10D	3.0	3.92	14.5	21.5	1.5	

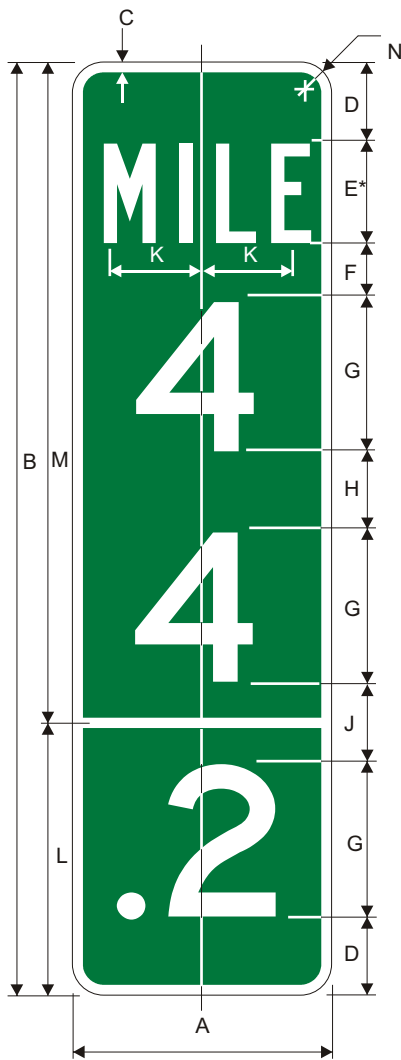

D10-2A

Road Class	Dimensions (inches)						
	A	B	C	D	E	F	
Mn/Conv	10	36	0.5	3.0	4B	2.0	
Expy/Fwy	12	48	0.5	2.0	4B	3.0	
	G	H	J	K	L	M	N
6D	3.0	3.0	3.92	10.5	25.5	1.5	
10D	3.0	4.0	3.92	14.0	34	1.5	

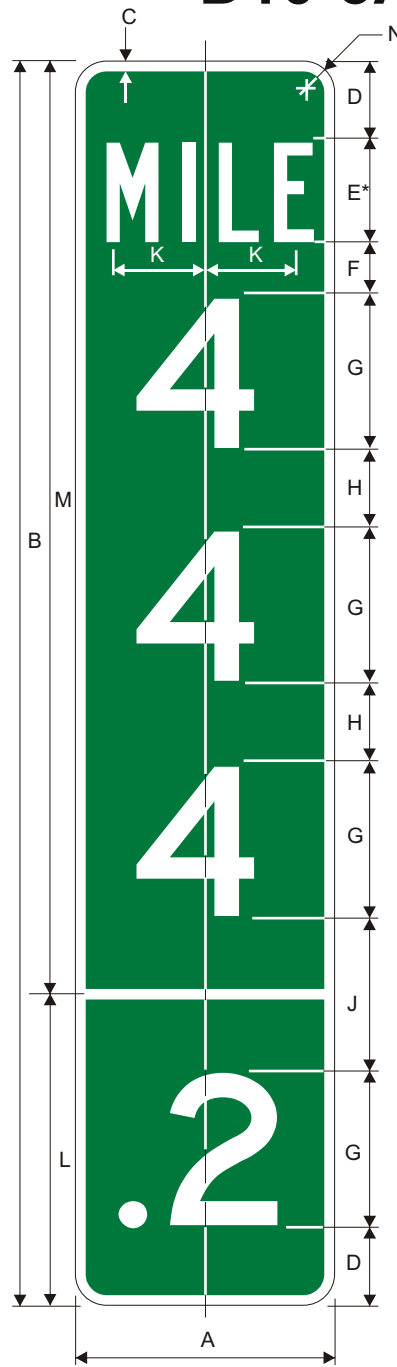

D10-3A

Road Class	Dimensions (inches)						
	A	B	C	D	E	F	
Mn/Conv	10	48	0.5	3.0	4B	2.0	
Expy/Fwy	12	60	0.5	2.0	4B	3.0	
	G	H	J	K	L	M	N
6D	3.0	6.0	3.92	12	36	1.5	
10D	2.0	5.0	3.92	14.5	45.5	1.5	

Optically locate numerals about centerline.

Border and Legend: White
 Background: Green

D10-101
 D10-102
 D10-103
 D10-104

Message on both
 sides of sign

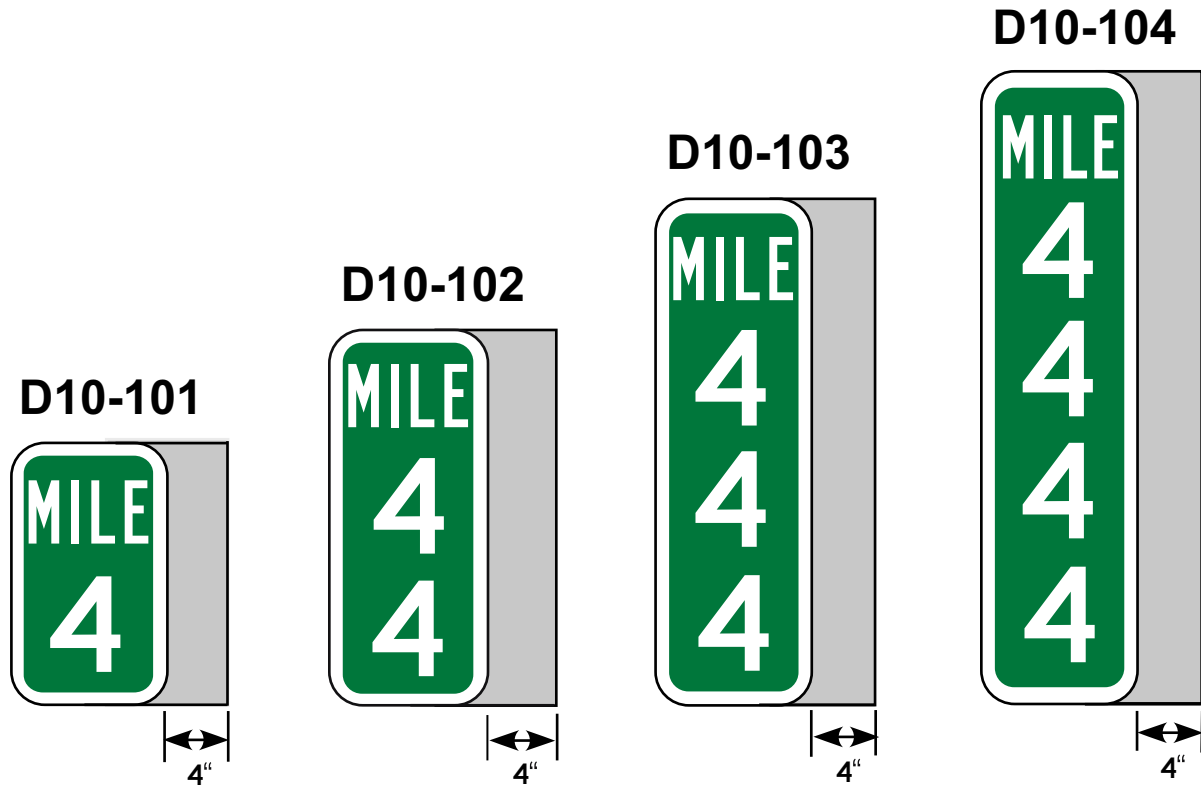

Note: 4" mounting area may be bare aluminum or green reflective material.

Border and Legend: White
 Background: Green

Sign Number	Sign Size	Dimensions (inches)			
		Letter Size and Series	Num. Size and Series	Border Width	Corner Radius
D10-101	14 x 18	4B	6D	0.5	1
	16 x 24	4C	10D	0.75	1.5
D10-102	14 x 27	4B	6D	0.5	1
	16 x 36	4C	10D	0.75	1.5
D10-103	14 x 36	4B	6D	0.5	1
	16 x 48	4C	10D	0.75	1.5
D10-104	14 x 42	4B	6D	0.5	1
	16 x 66	4C	10D	0.75	1.5

D10-101A
 D10-102A
 D10-103A
 D10-104A

Message on both
 sides of sign

D10-101



D10-102



D10-103



D10-104



Note: 4" mounting area may be bare aluminum or green reflective material.

Border and Legend: White
 Background: Green

Dimensions (inches)

Sign Number	Sign Size	Letter Size and Series	Num. Size and Series	Border Width	Corner Radius
D10-101	14 x 18	4B	6D	0.5	1
	16 x 24	4C	10D	0.75	1.5
D10-102	14 x 27	4B	6D	0.5	1
	16 x 36	4C	10D	0.75	1.5
D10-103	14 x 36	4B	6D	0.5	1
	16 x 48	4C	10D	0.75	1.5
D10-104	14 x 42	4B	6D	0.5	1
	16 x 66	4C	10D	0.75	1.5

DESTINATION SIGNS - BIKE ROUTE, WEATHER, CAR POOL INFO

D11-1 to D11-102



*Make symbol proportional to graphic shown.

Border and Legend: White
Background: Green

Road Class	Dimensions (inches)									
	A	B	C	D	E	F	G	H	J	K
Minimum	24	18	0.50	1.50	7.00	3.50	3C	5.50	1.50	1.50
Conventional	30	24	0.63	1.88	8.75	4.38	4C	6.88	3.11	1.75

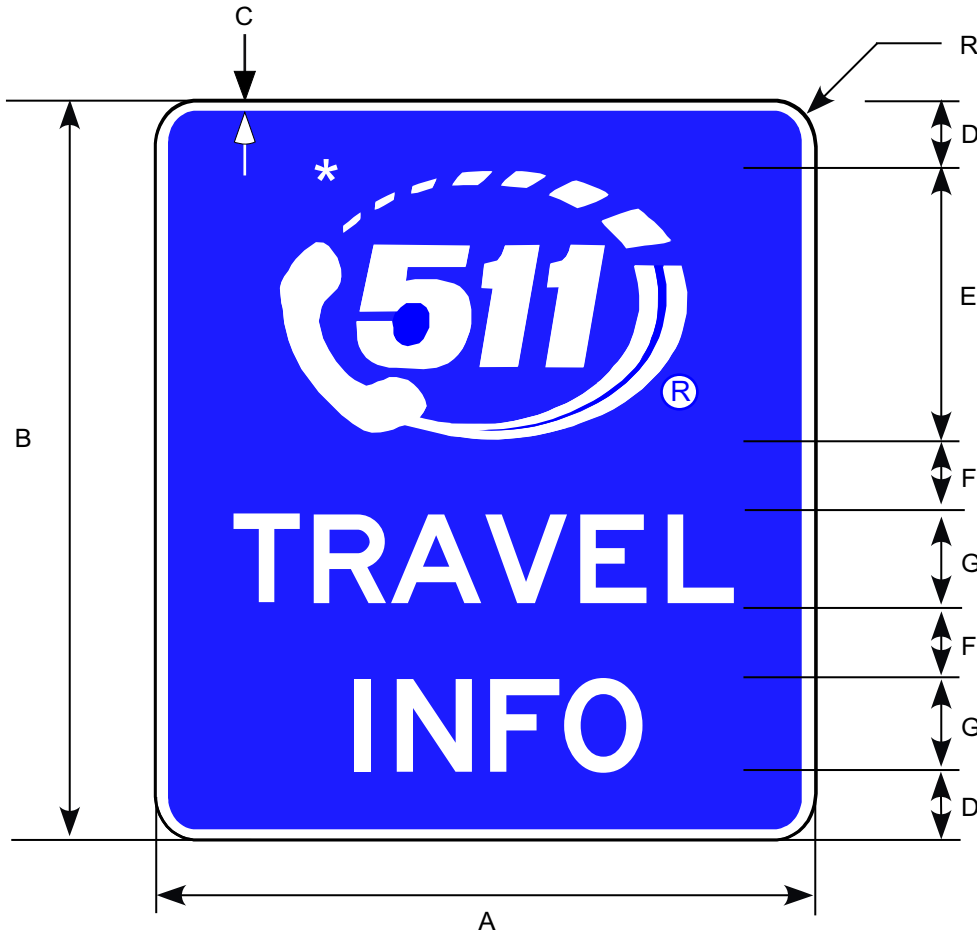

Border, Symbol and Legend: White
Background: Blue

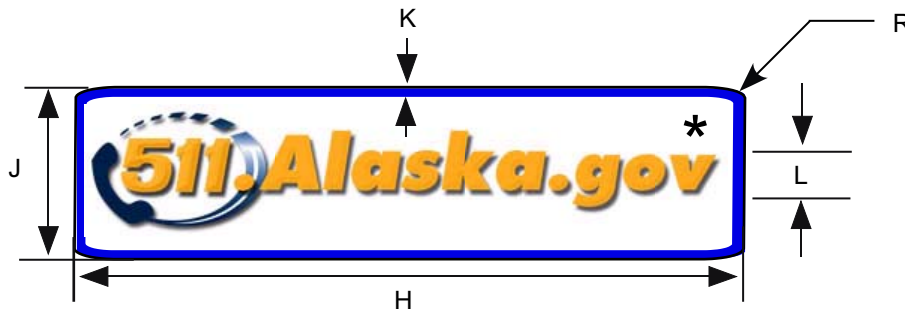

Only use plate with above sign off roads, for example at Ferry & Airport Terminals and Road Side Rest Areas.

* Make symbol and lettering proportional to graphic shown.

Border and Symbol: Blue
Legend: Orange
Background: White

Road Class	Dimensions (inches)											
	A	B	C	D	E	F	G	H	J	K	L	R
Off Roads (Terminals)	24	30	0.38	3.0	10	3.0	4D	30	6.0	0.38	2.0	1.5
Conventional	36	48	0.63	5.0	16	5.0	6D	N/A	N/A	N/A	N/A	2.25
Expressway	48	60	0.75	7.0	18	6.0	8D	N/A	N/A	N/A	N/A	3.0

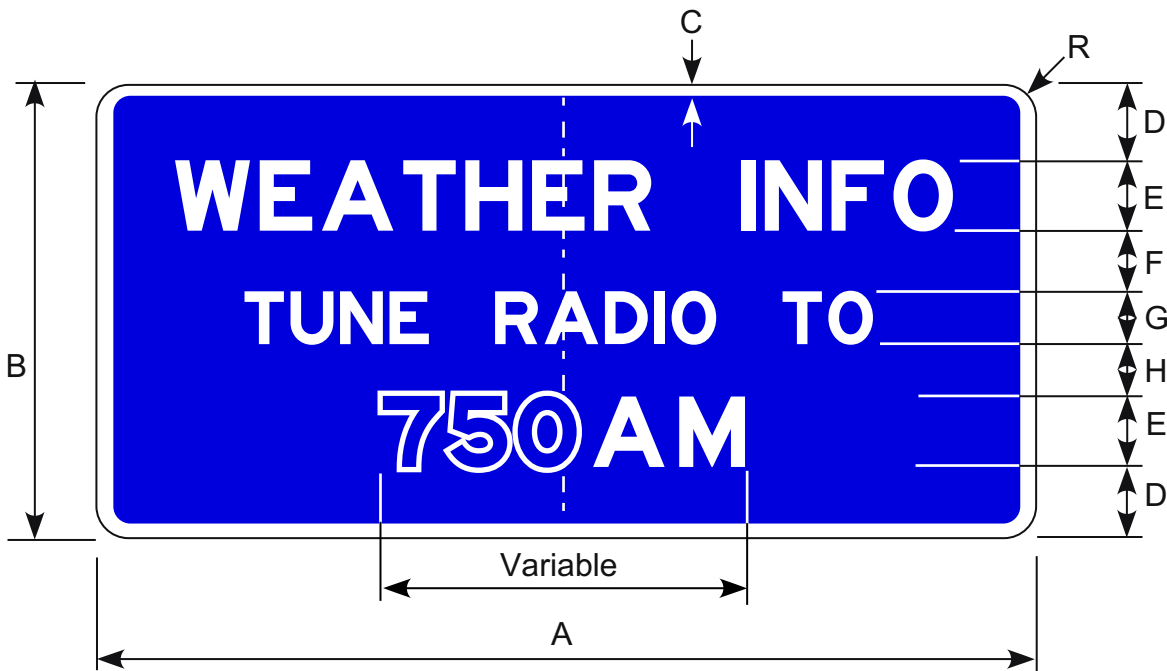

Border and Legend: White
Background: Blue

Note: Radio frequency as noted on the plans.

Prior to the 2002 publication of this manual,
this sign was numbered D12-1.

Road Class	Dimensions (inches)									
	A	B	C	D	E	F	G	H	R	
Minimum	84	42	1.5	8.5	6E	5	4E	4	2.60	
Conventional	108	54	2.0	9.5	8E	7	6E	6	3.38	
Expwy/Fwy	132	72	2.0	13.5	10E	9	8E	8	4.50	

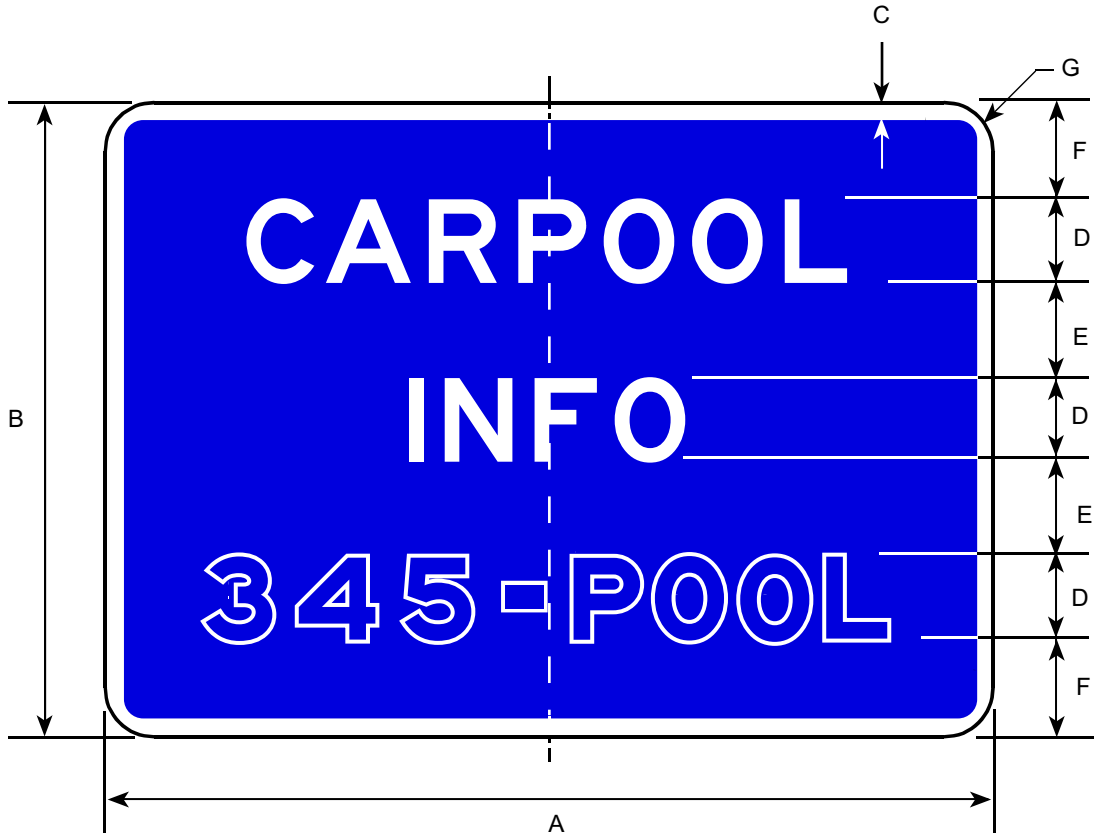

Note: Telephone number as noted on the plans.

Border and Legend: White Background: Blue

Prior to the 2002 publication of this manual, this sign was numbered D12-2.

Road Class	Dimensions (inches)						
	A	B	C	D	E	F	G
Minimum	48	30	0.75	4E	4.25	4.75	2.25
Conventional	60	48	1.0	6E	6.0	9.0	3.0
Expressway	72	54	1.5	8E	7.0	8.0	4.0

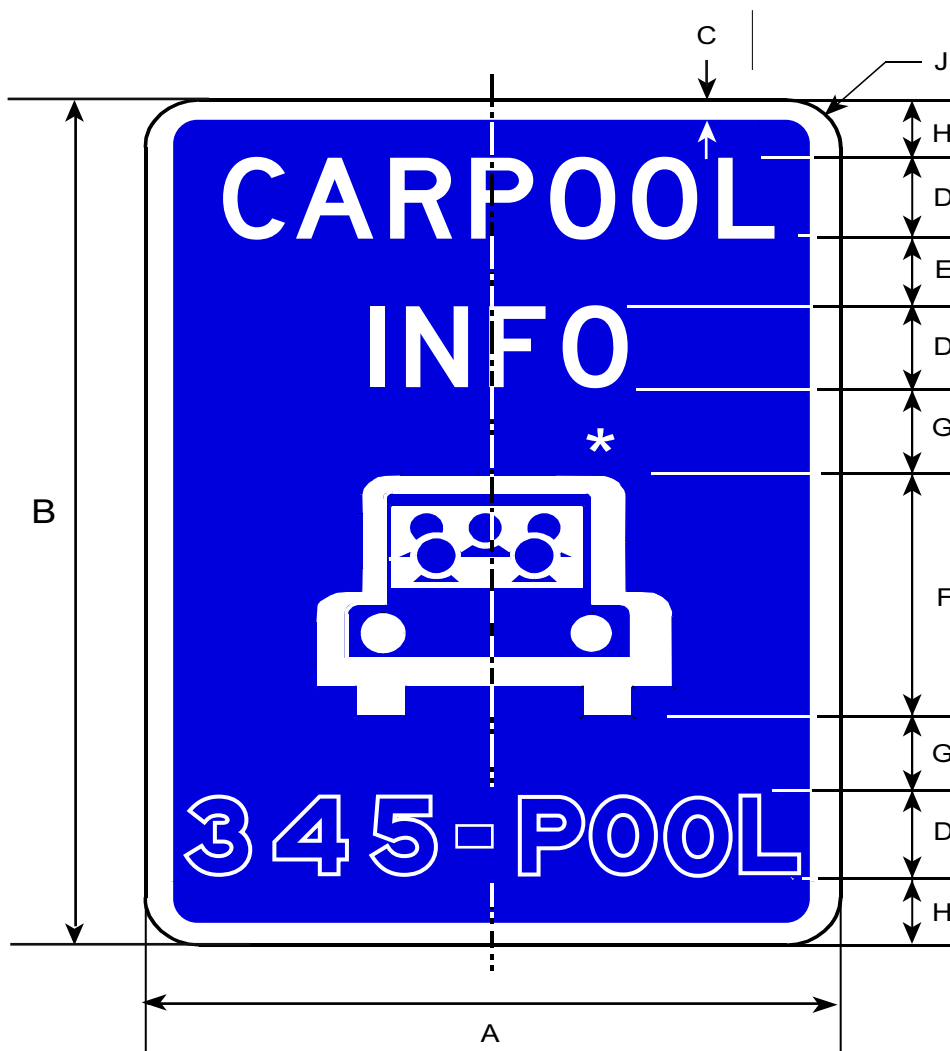

*Make symbol proportional to graphic shown.

Border and Legend: White
Background: Blue

Note: Telephone number as noted on the plans.

Road Class	Dimensions (inches)								
	A	B	C	D	E	F	G	H	J
Conv & Min	30	48	0.75	4D	3	12	4	6.5	4.5

DESTINATION SIGNS - FREEWAY ENTRANCE

D13-3 to D13-3A

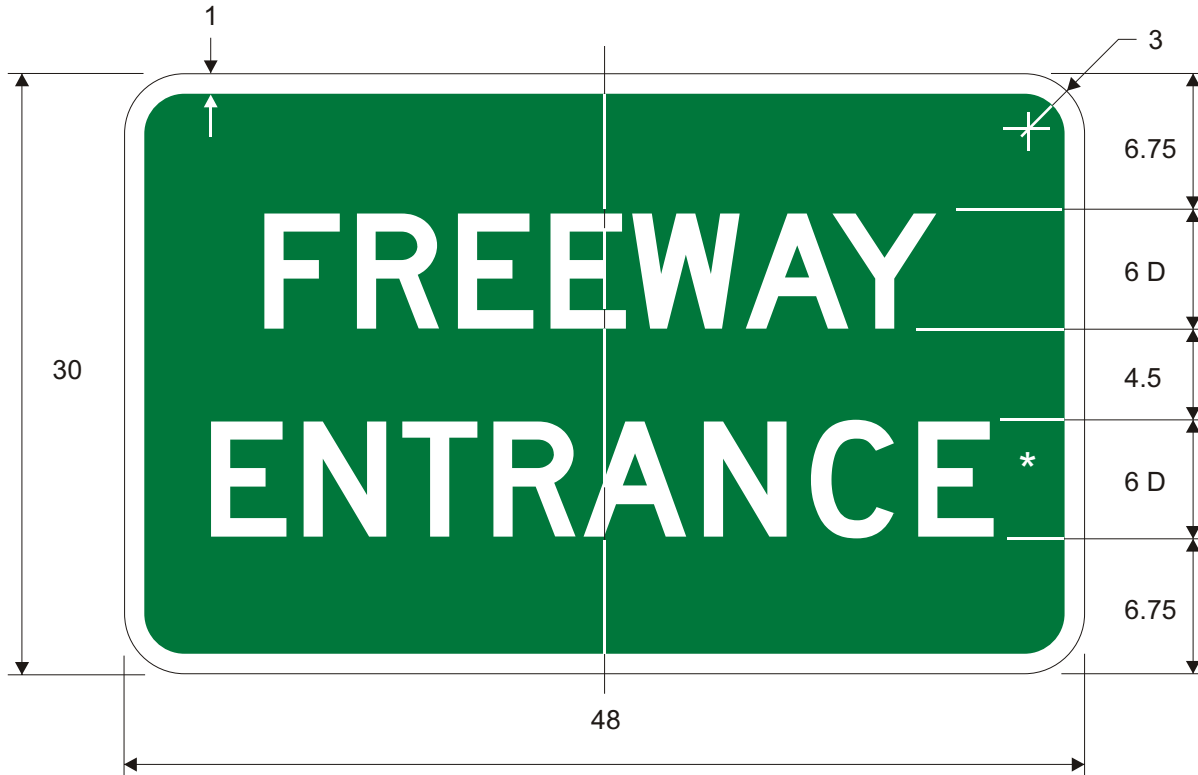

*Reduce spacing to fit.

Border and Legend: White
Background: Green

D13-3A



D13-3AR



D13-3AL

*Reduce spacing to fit.
**See Appendix B-4 for Arrow Details.

Border and Legend: White
Background: Green

DESTINATION SIGNS - EXPWYS & FWYS

E1-5 to E11-1

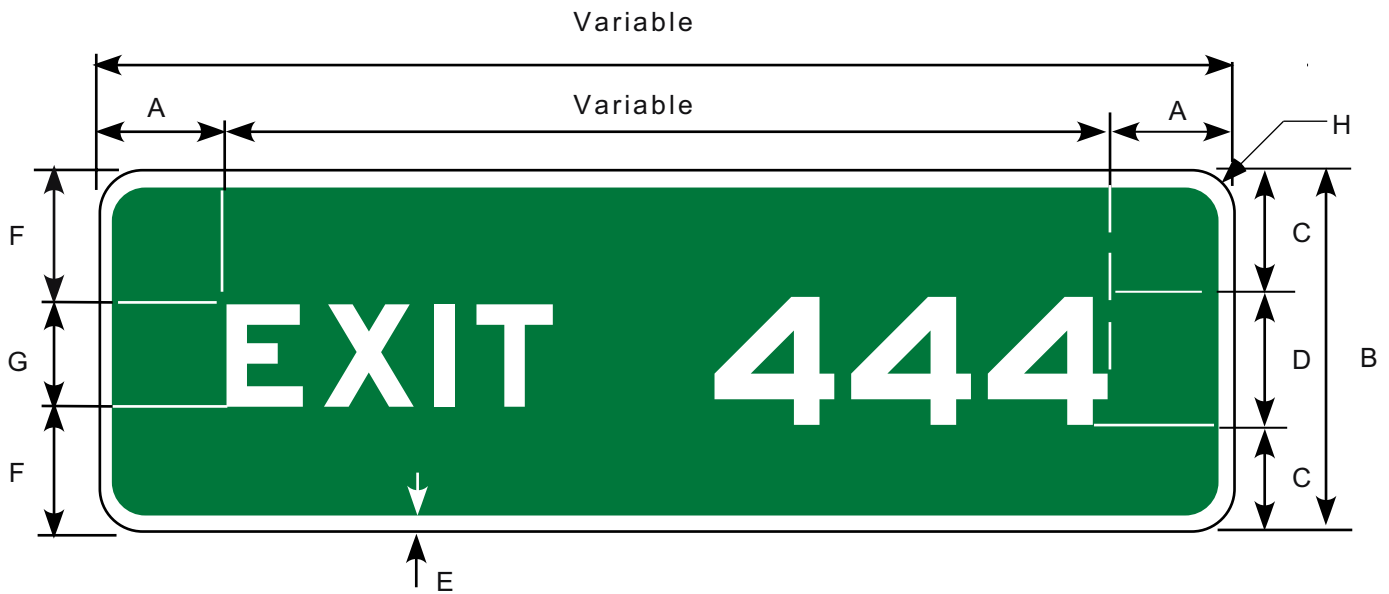

Border and Legend: White
 Background: Green

Letter Size (inches)	Dimensions (inches)							
	A	B	C	D	E	F	G	H
16 / 12	12±	42	13	16	2	15	12	2.25



Border and Legend: White
 Background: Green
 Marker: Black on White

*Make symbol proportional to graphic shown

Letter Size (inches)	Dimensions (inches)								
	A	B	C	D	E	F	G	H	J
16 / 12	36	110	2	10±	12	10	16/12	15	4

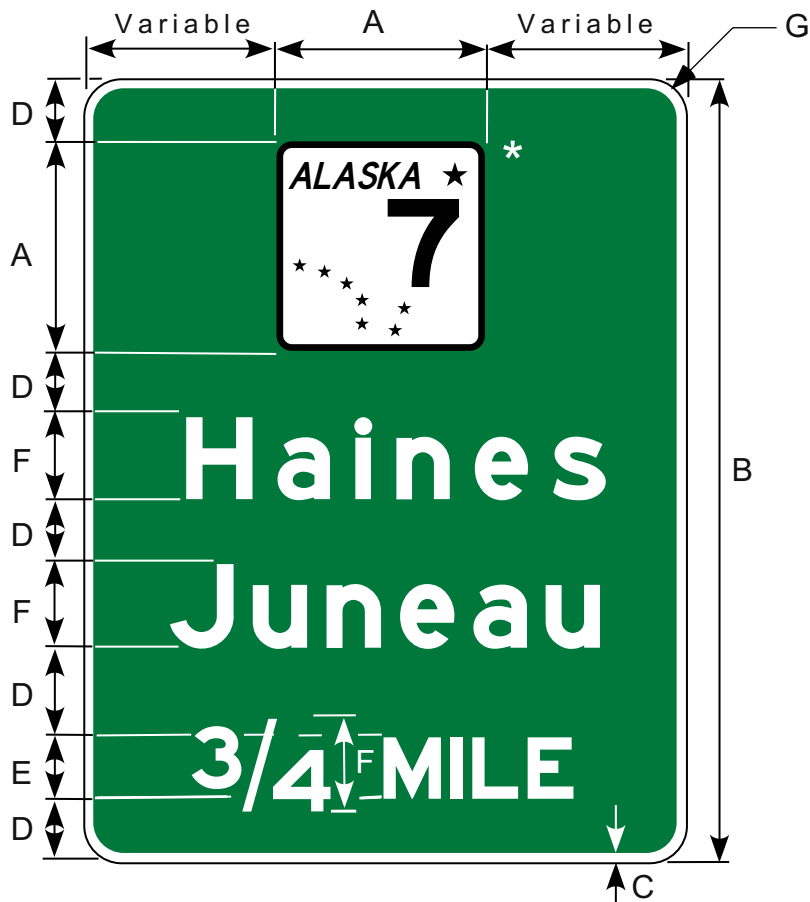

Border and Legend: White
 Background: Green
 Marker: Black on White

* Make symbol proportional to graphic shown

Letter Size (inches)	Dimensions (inches)						
	A	B	C	D	E	F	G
16 / 12	36	138	2	12	10	16/12	4

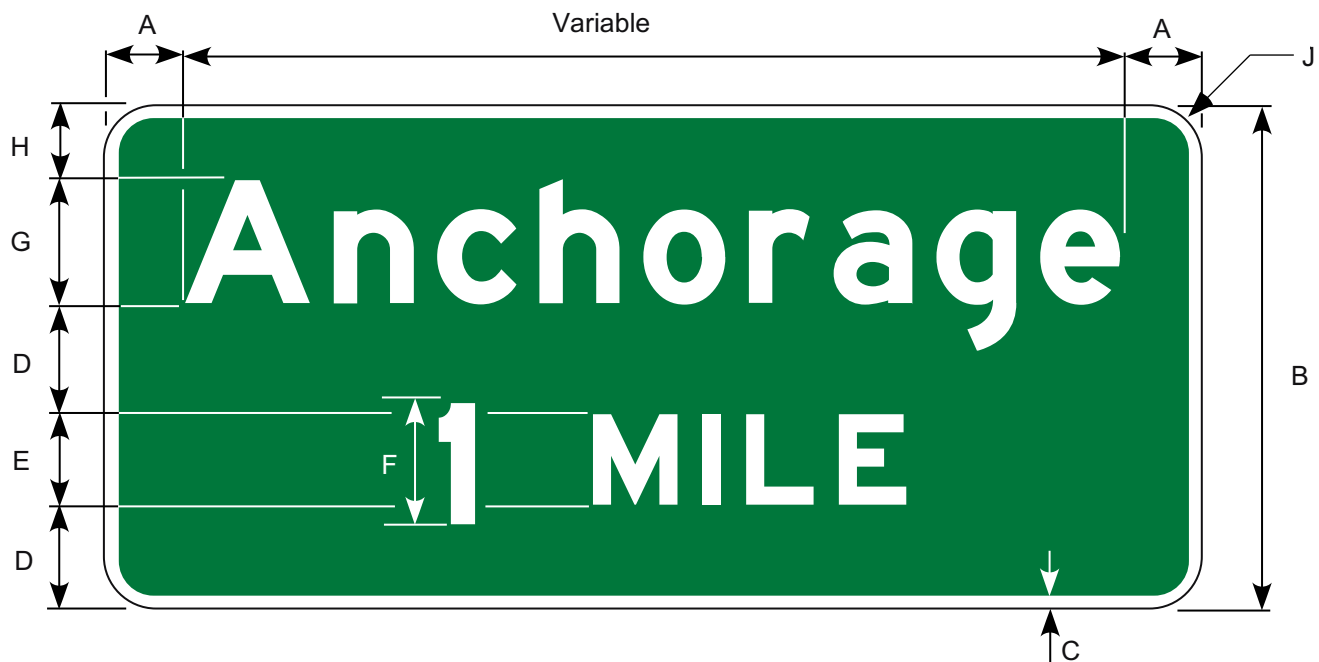

Border and Legend: White
 Background: Green

Letter Size (inches)	Dimensions (inches)								
	A	B	C	D	E	F	G	H	J
16 / 12	16±	60	2	12	10	16	16/12	10	3.75

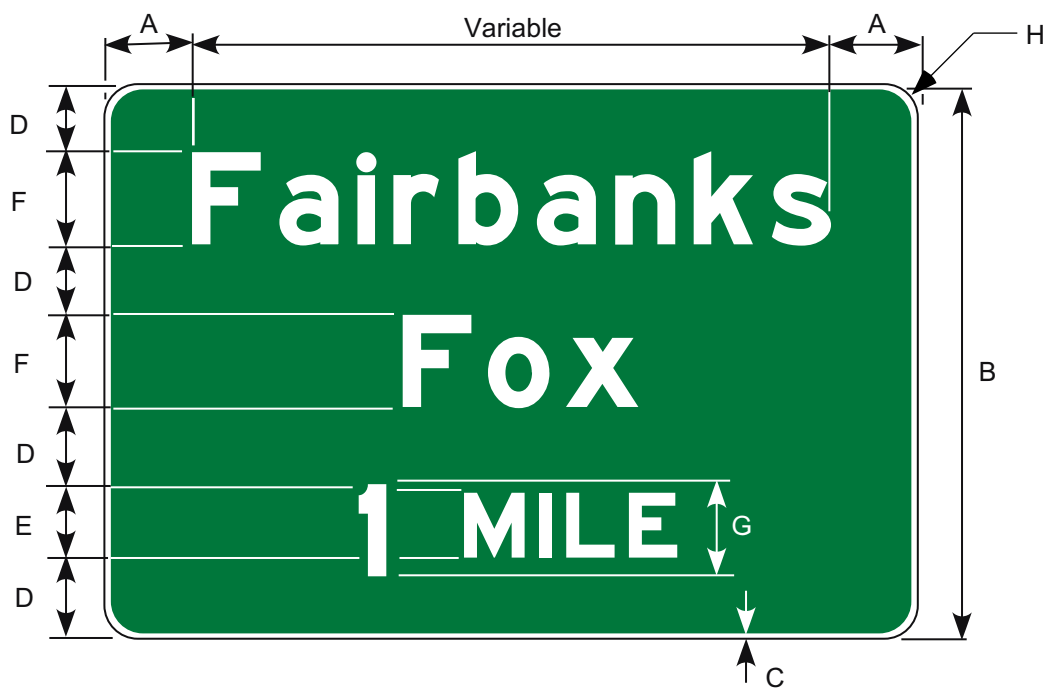

Border and Legend: White
 Background: Green

Letter Size (inches)	Dimensions (inches)							
	A	B	C	D	E	F	G	H
16 / 12	16±	90	2	12	10	16/12	15	4

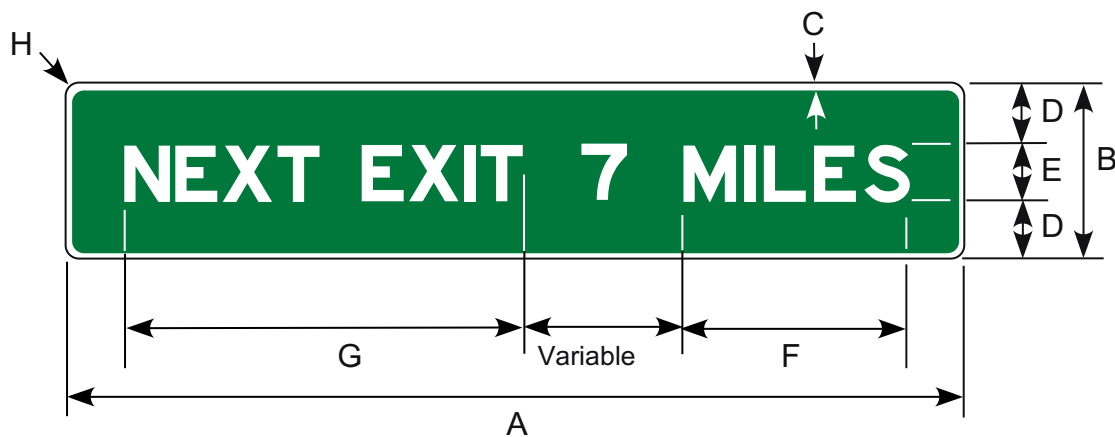

Border and Legend: White
 Background: Green

Letter Size (inches)	Dimensions (inches)							
	A	B	C	D	E	F	G	H
10	156	30	0.75	10	10	38.25	69.81	1.88

E2-1A

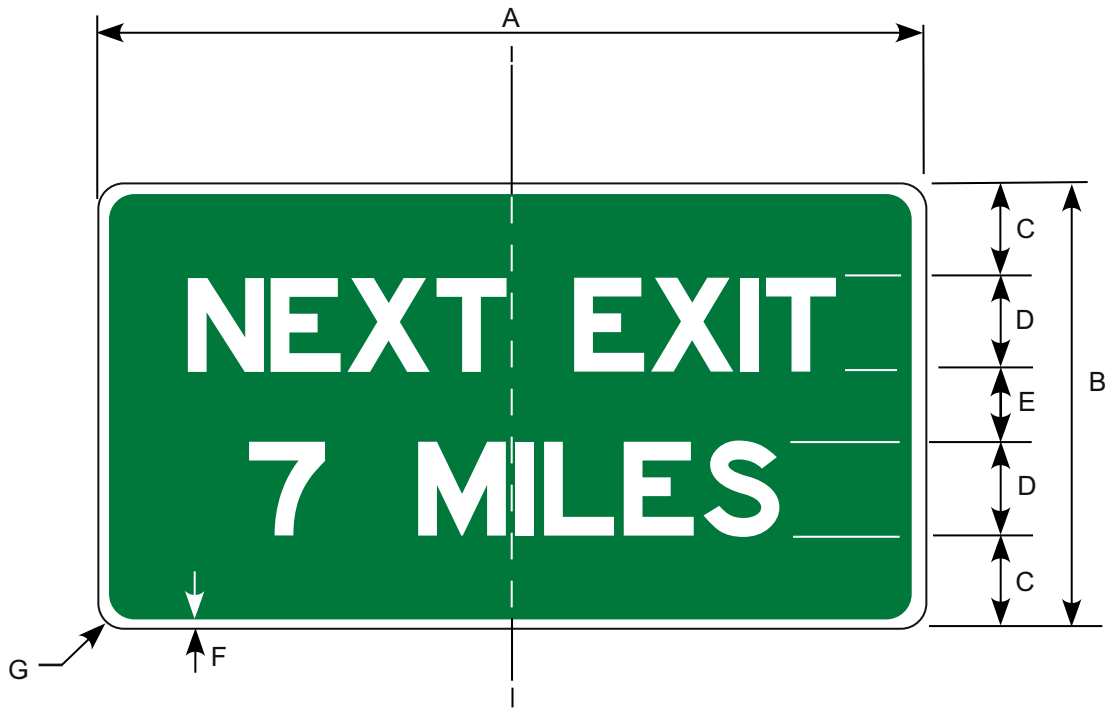

Border and Legend: White
Background: Green

Letter Size (inches)	Dimensions (inches)						
	A	B	C	D	E	F	G
10	90	48	10	10	8	1.25	3



Border and Legend: White
 Background: Green

Letter Size (inches)	Dimensions (inches)							
	A	B	C	D	E	F	G	H
16 / 12	12±	66	2.0	12	12	14	16/12	4.0

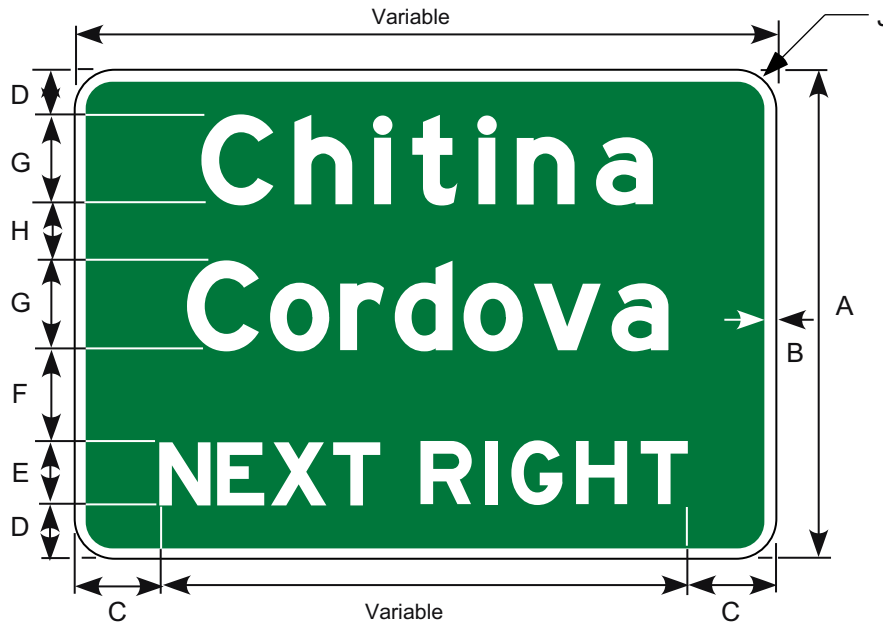

Border and Legend: White
 Background: Green

Letter Size (inches)	Dimensions (inches)								
	A	B	C	D	E	F	G	H	J
16 / 12	90	2.0	12±	10	12	14	16/12	12	4.0

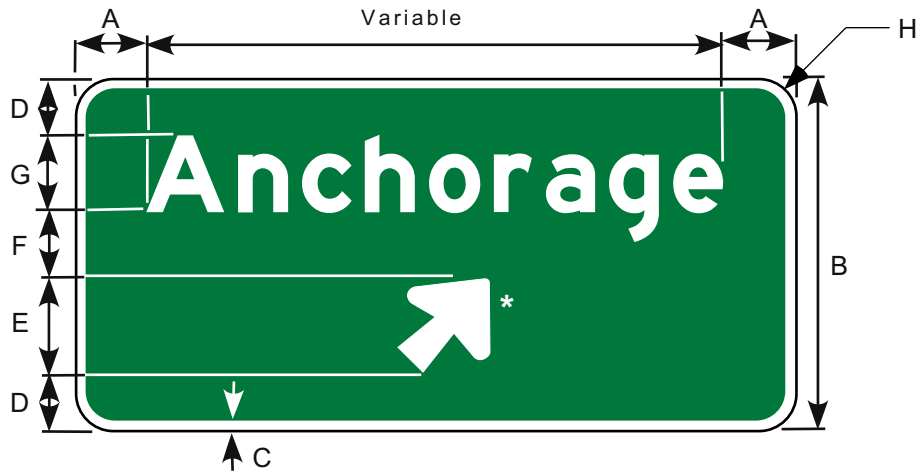

Border and Legend: White
Background: Green

* See Appendix B-4 for Arrow Details.

Letter Size (inches)	Dimensions (inches)							
	A	B	C	D	E	F	G	H
16 / 12	16±	72	2.0	10	24	12	16/12	4.0

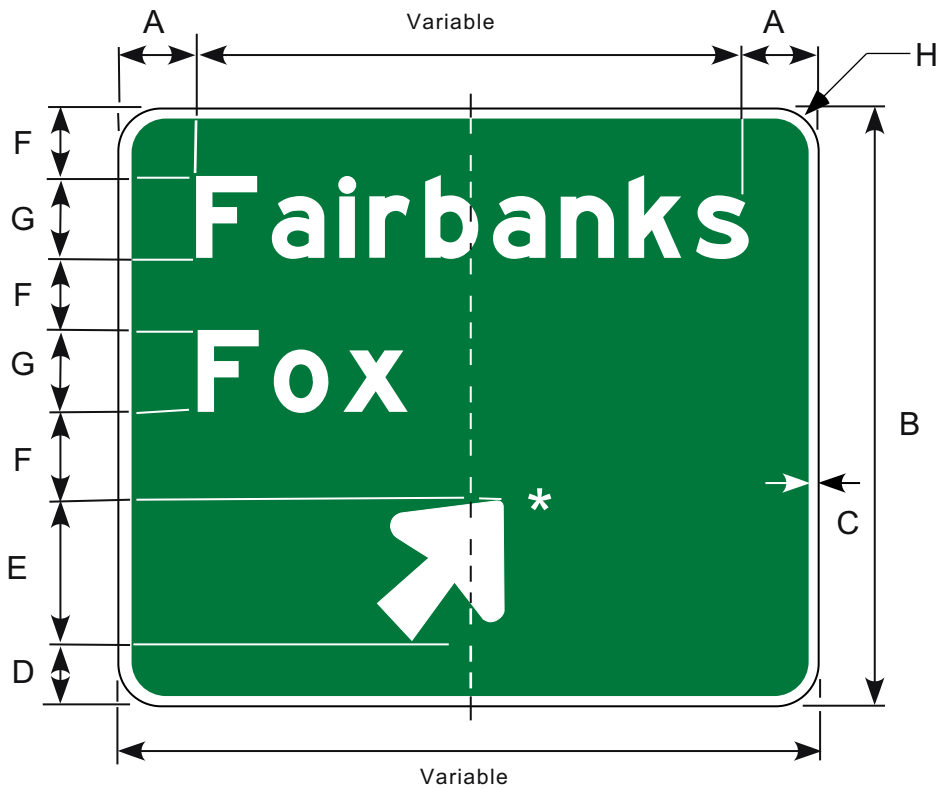

Border and Legend: White
Background: Green

* See Appendix B-4 for Arrow Details.

Letter Size (inches)	Dimensions (inches)							
	A	B	C	D	E	F	G	H
16 / 12	16±	102	2.0	10	24	12	16/12	4.0

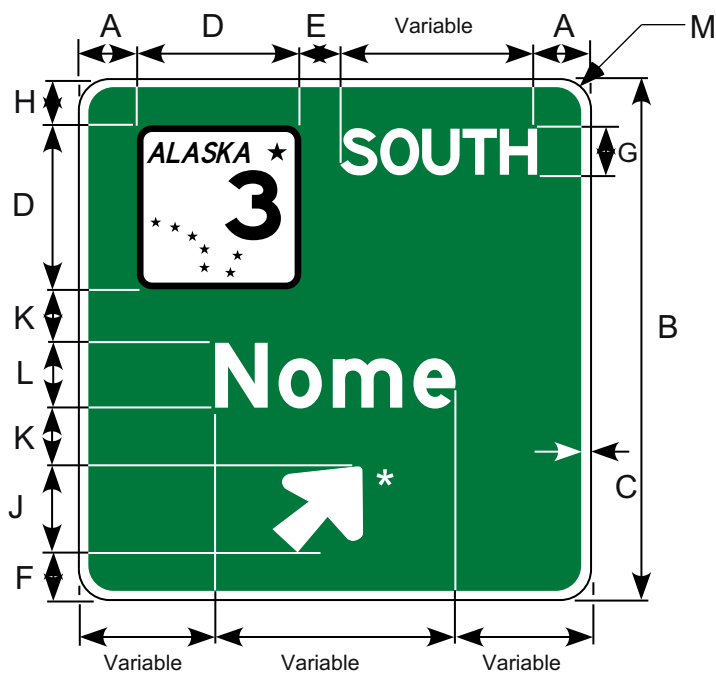

Border and Legend: White
 Background: Green
 Marker: Black on White

* See Appendix B-4 for Arrow Details.

Make symbol proportional to graphic shown

Letter Size (inches)	Dimensions (inches)											
	A	B	C	D	E	F	G	H	J	K	L	M
16 / 12	10±	120	2.0	36	3.0	10	12D	10	24	12	16/12	4.0

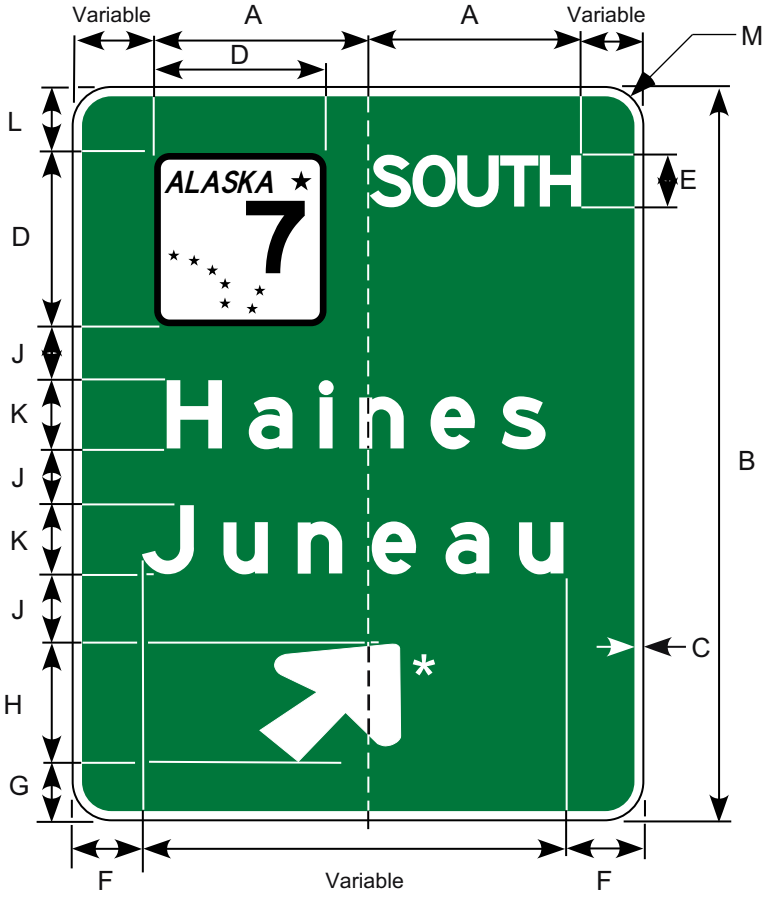

Border and Legend: White
 Background: Green
 Marker: Black on White

* See Appendix B-4 for
 Standard Arrow Details.

Make symbol proportional to graphic shown

Letter Size (inches)	Dimensions (inches)											
	A	B	C	D	E	F	G	H	J	K	L	M
16 / 12	50	150	2.0	36	12D	16	10	24	12	16/12	12	4.0

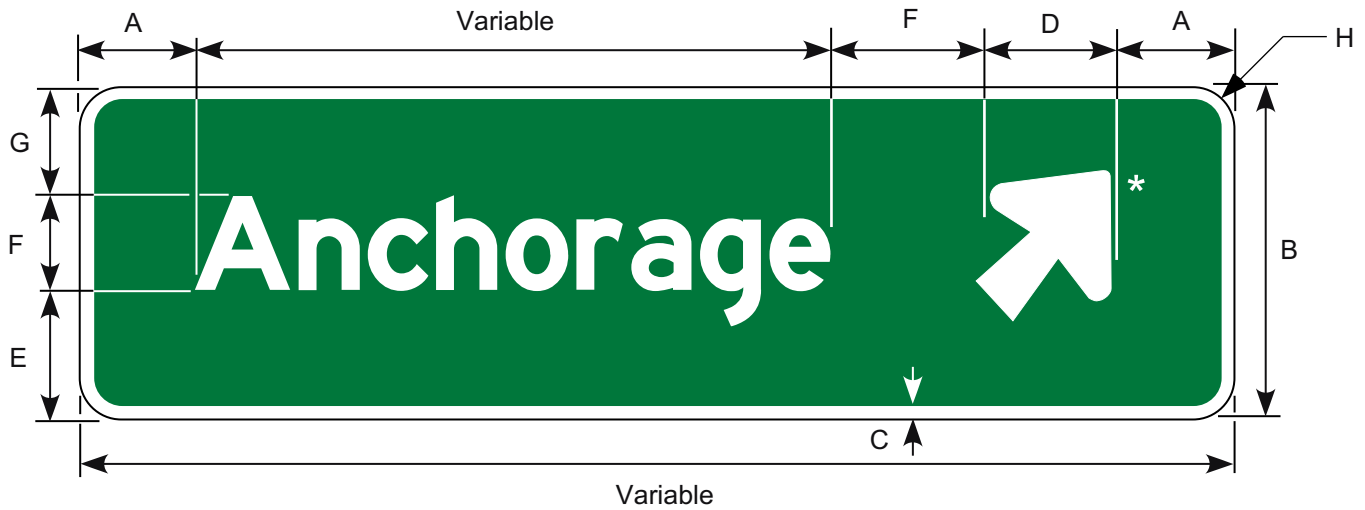

Border and Legend: White
Background: Green

* See Appendix B-4 for Arrow Details.

Letter Size (inches)	Dimensions (inches)							
	A	B	C	D	E	F	G	H
16 / 12	16	42	2.0	20.25	14	16/12	12	2.63

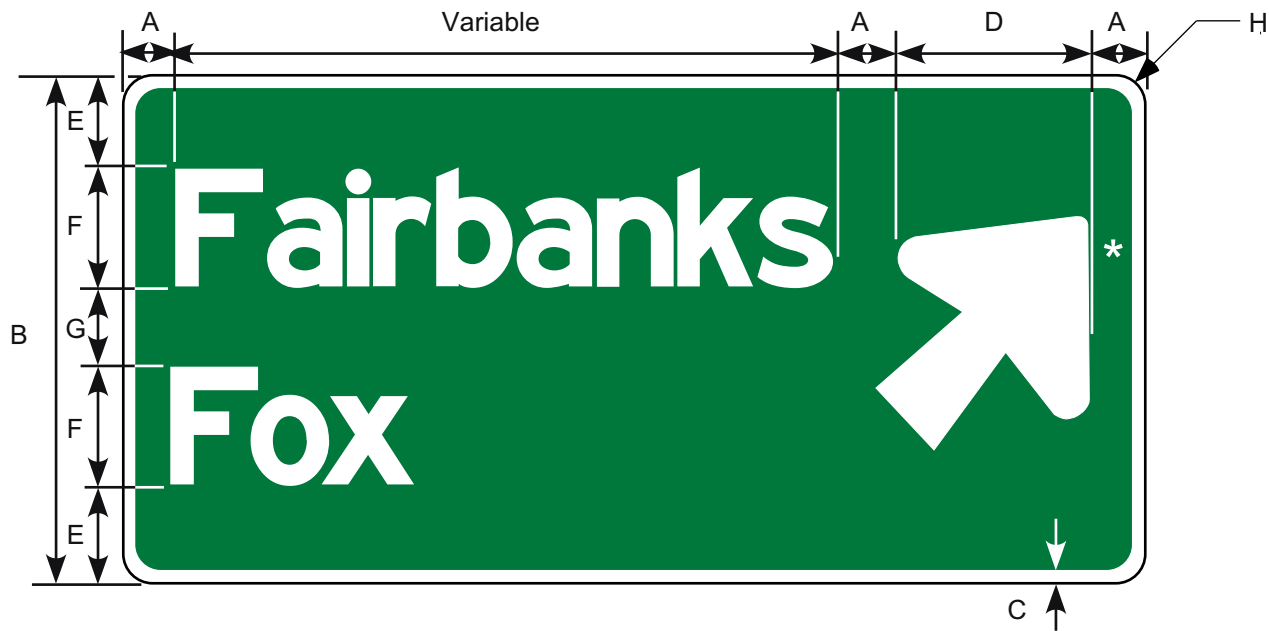

Border and Legend: White
Background: Green

* See Appendix B-4 for Arrow Details.

Letter Size (inches)	Dimensions (inches)							
	A	B	C	D	E	F	G	H
16 / 12	16	72	2.0	23.63	14	16/12	12	4.0

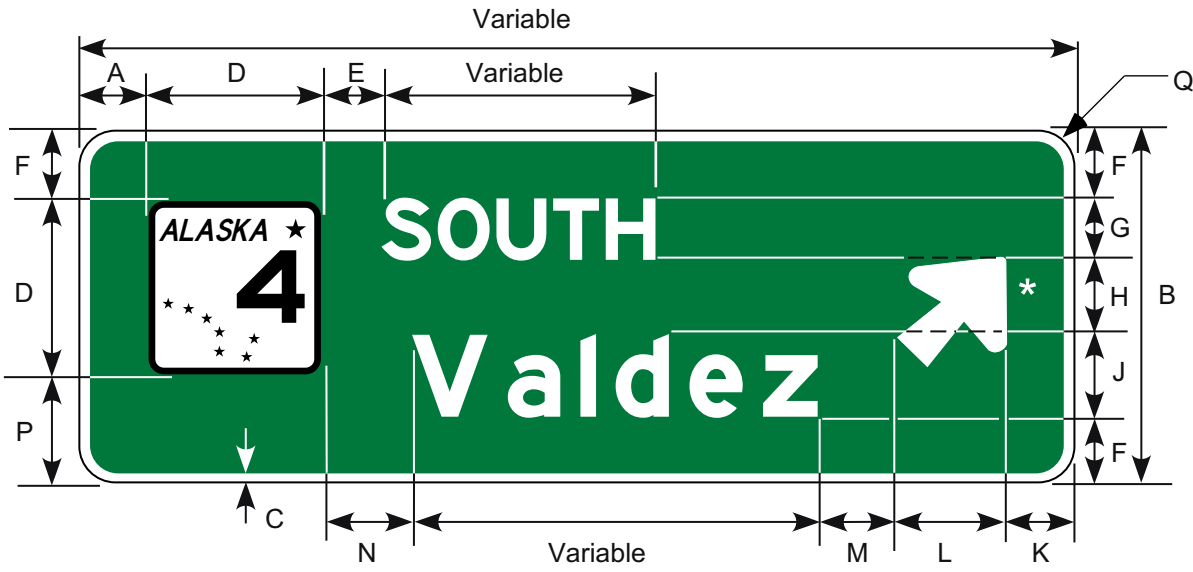

Border and Legend: White
 Background: Green
 Marker: Black on White

* See Appendix B-4 for Arrow Details.

Make symbol proportional to graphic shown

Letter Size (inches)	Dimensions (inches)														
	A	B	C	D	E	F	G	H	J	K	L	M	N	P	Q
16 / 12	14	72	2.0	36	12	14	12	16	16/12	14±	23.63	16±	18	22	4.0

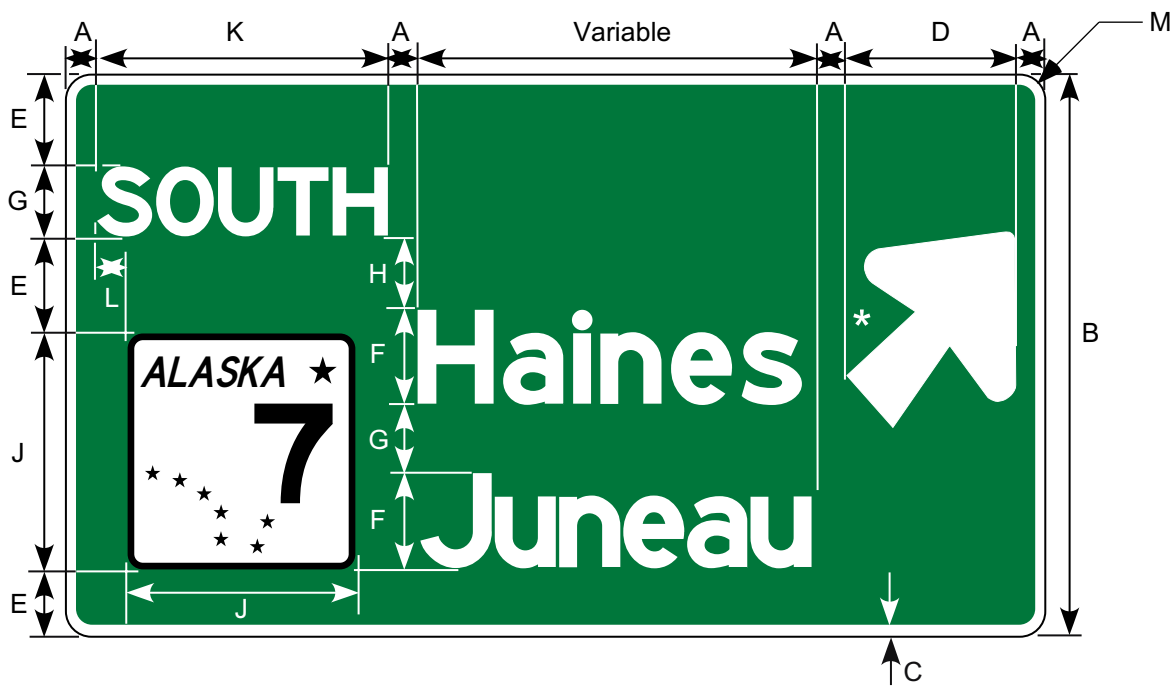

Border and Legend: White
 Background: Green
 Marker: Black on White

* See Appendix B-4 for Arrow Details.

Make symbol proportional to graphic shown

Letter Size (inches)	Dimensions (inches)											
	A	B	C	D	E	F	G	H	J	K	L	M
16 / 12	16	90	2.0	23.63	14	16/12	12	6.0	36	VAR	(K-36)/2	4.0

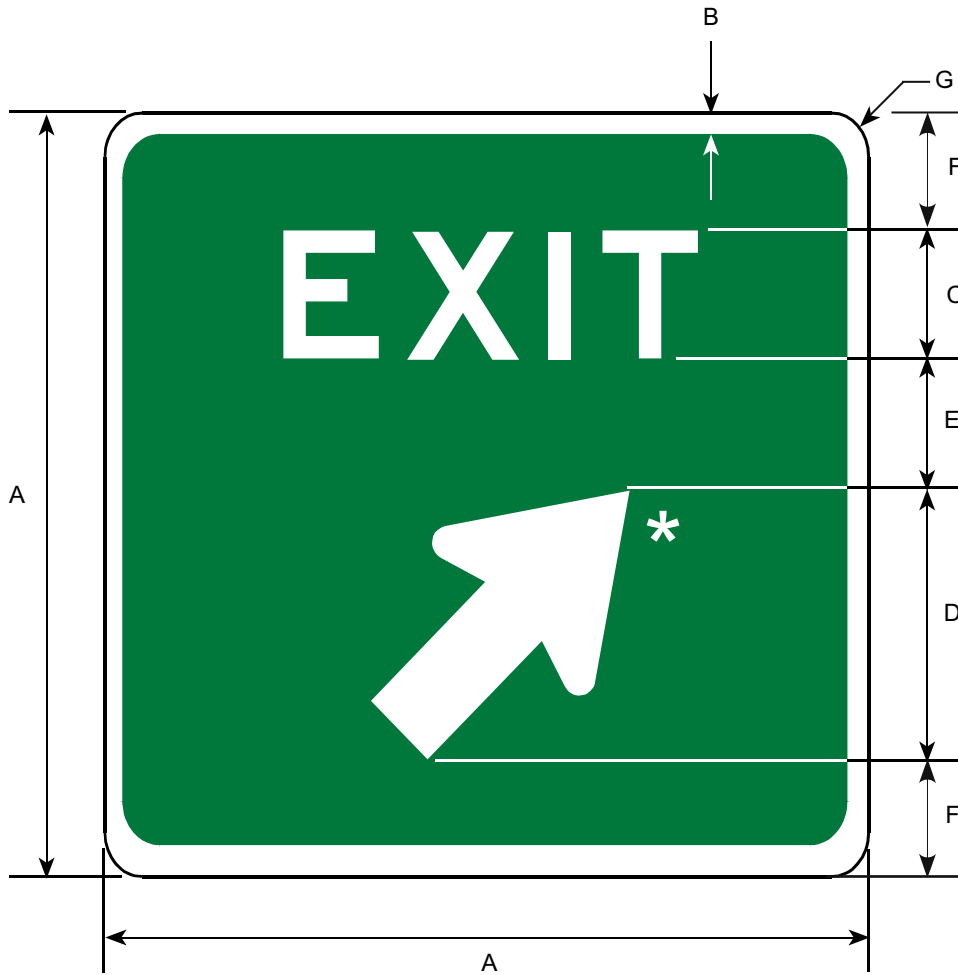

Border and Legend: White
Background: Green

* See Appendix B-4 for Arrow Details.

Road Class	Dimensions (inches)						
	A	B	C	D	E	F	G
Minimum	48	1.5	8.0	16.38	8.0	7.81	3.0
Conventional	60	2.0	10	23.62	10	8.19	3.75

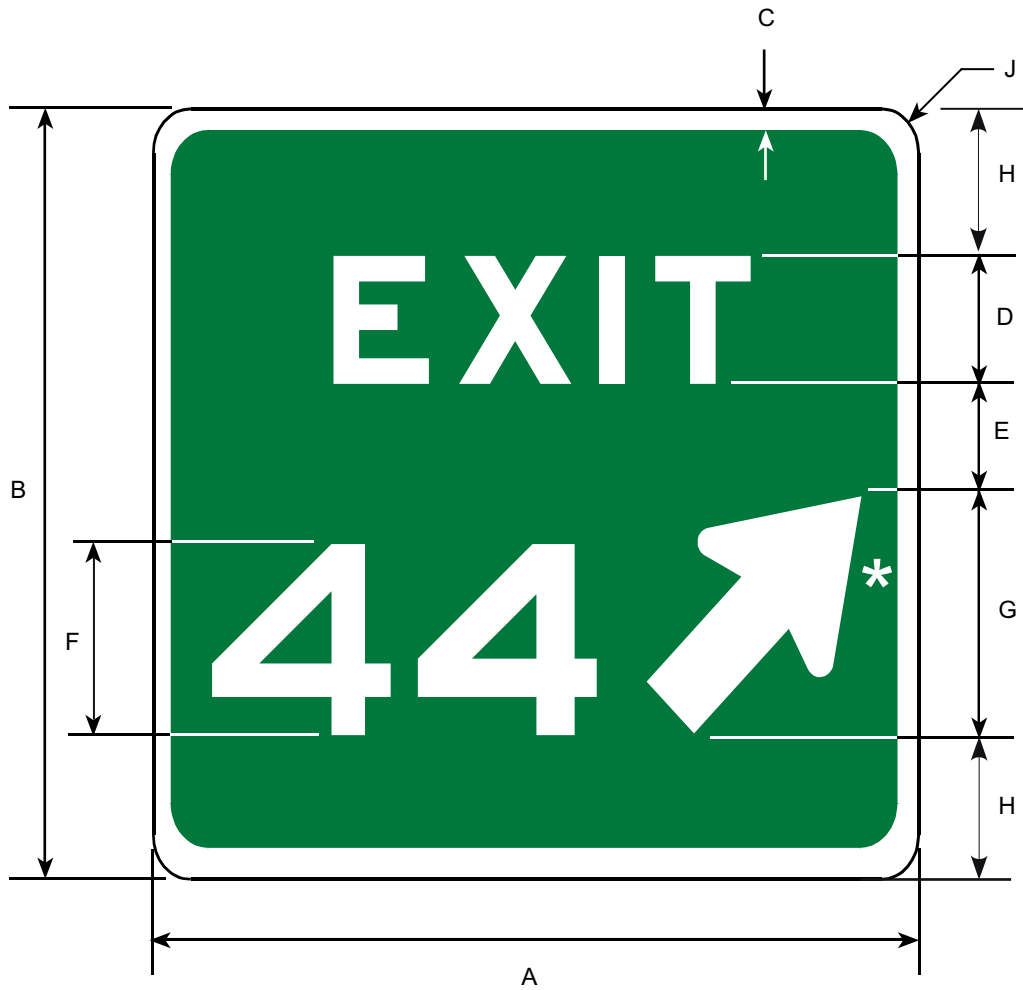

Border and Legend: White
Background: Green

* See Appendix B-4 for Arrow Details.

Road Class	Dimensions (inches)								
	A	B	C	D	E	F	G	H	J
Minimum	VAR	48	1.5	8E	8.0	12	16.38	7.81	3.0
Conventional	VAR	60	2.0	10E	10	15	23.62	8.19	3.75

E5-2
E5-2A
E5-3

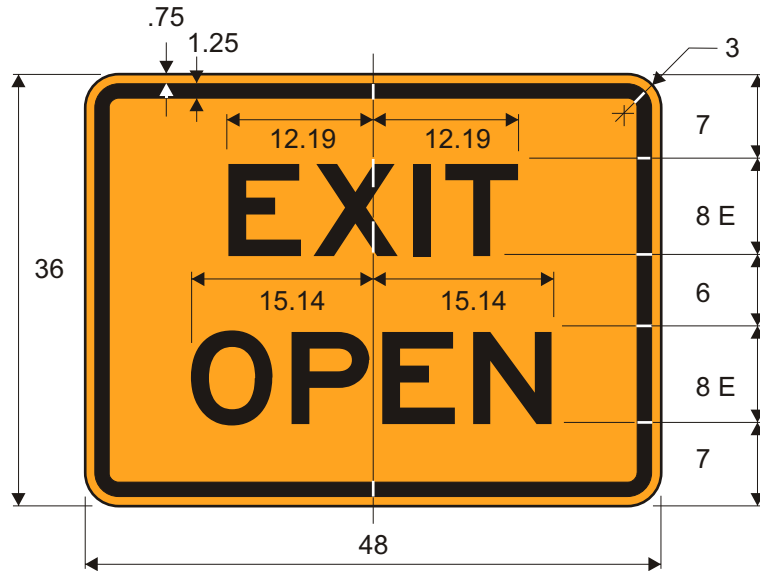

E5-2

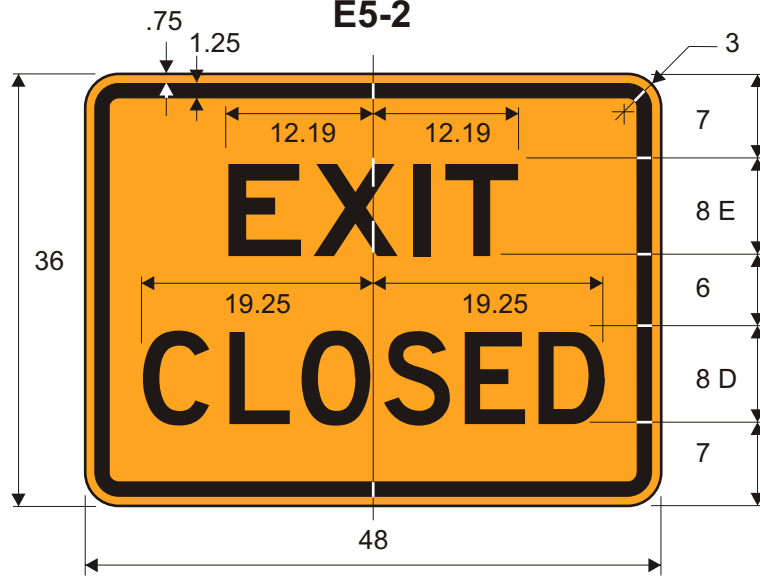

E5-2a

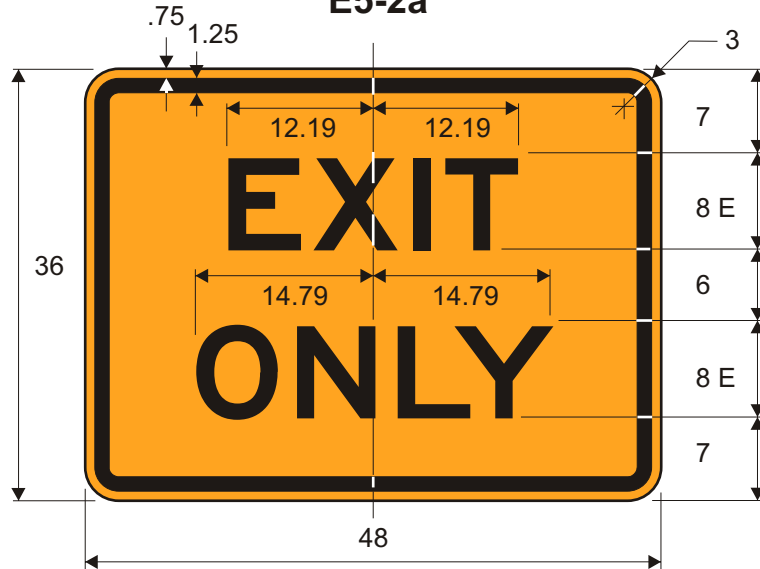

E5-3

Border and Legend: Black
 Background: Orange

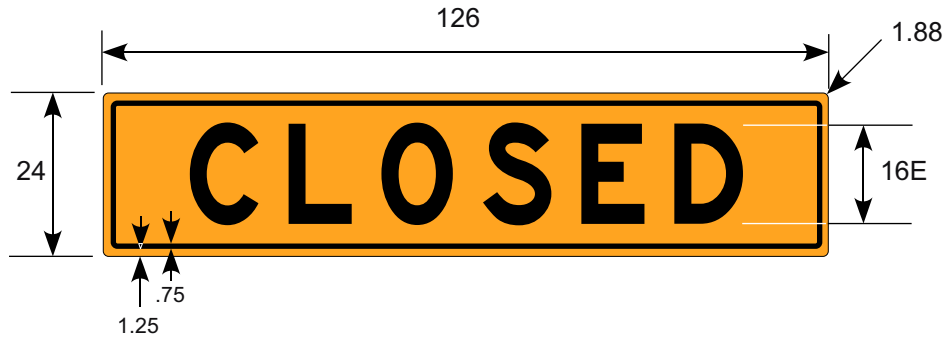

Border and Legend: Black
Background: Orange

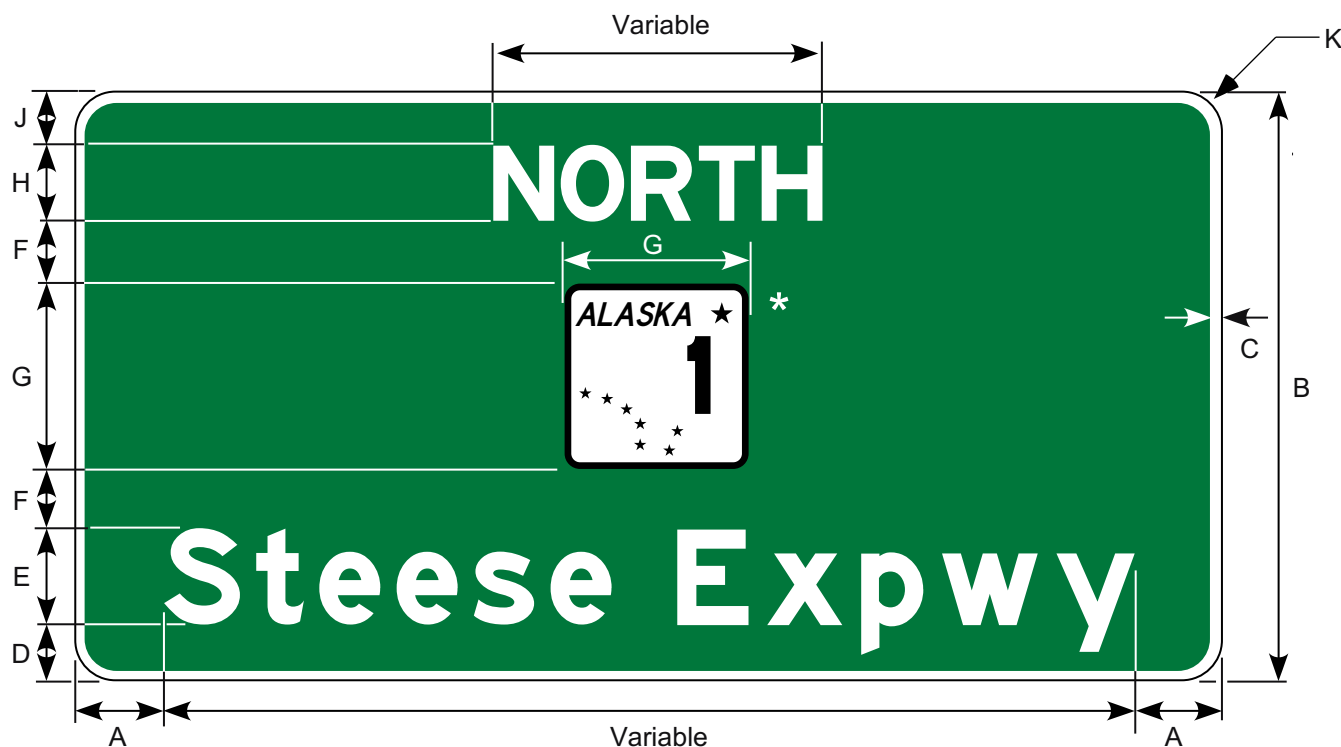

Border and Legend: White
 Background: Green
 Marker: Black on White

* Make symbol proportional to graphic shown

Letter Size (inches)	Dimensions (inches)									
	A	B	C	D	E	F	G	H	J	K
16 / 12	16±	108	2	10	16/12	12	36	12	10	4

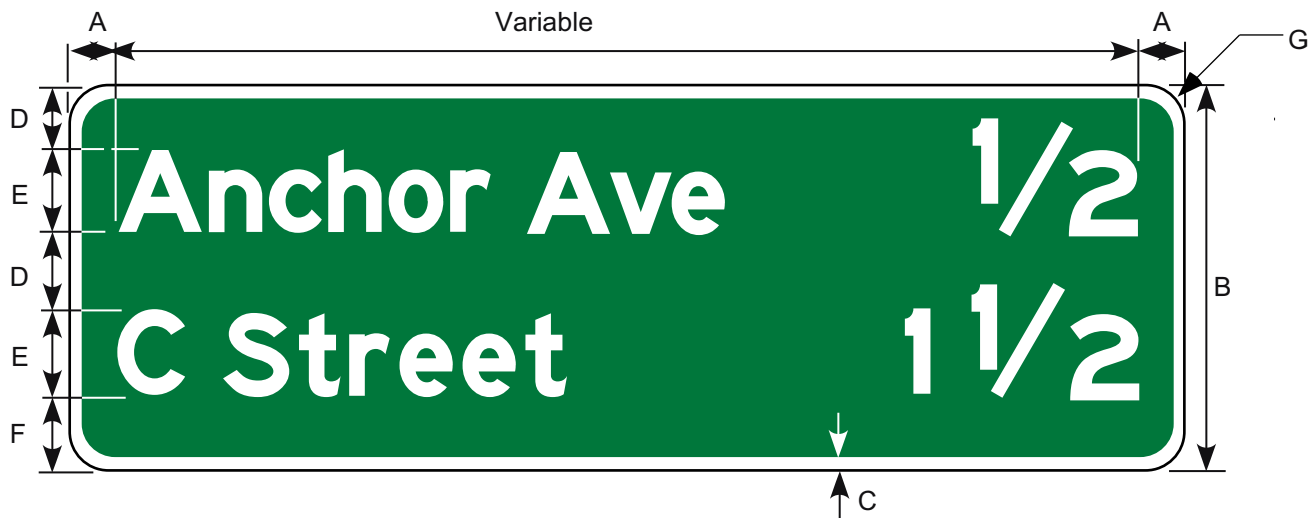

Border and Legend: White
 Background: Green

Letter Size (inches)	Dimensions (inches)						
	A	B	C	D	E	F	G
16 / 12	16±	66	0.50	12	16/12	10	4.0



Border and Legend: White
 Background: Green

Letter Size (inches)	Dimensions (inches)					
	A	B	C	D	E	F
16 / 12	16±	96	2	12	16/12	4



Border and Legend: White
 Background: Green

Letter Size (inches)	Dimensions (inches)								
	A	B	C	D	E	F	G	H	J
16 / 12	16±	60	2.0	16	11	10	16/12	12	3.75



Border and Legend: White
 Background: Green

Letter Size (inches)	Dimensions (inches)							
	A	B	C	D	E	F	G	H
16 / 12	16±	90	2.0	16	12	10	16/12	4.0

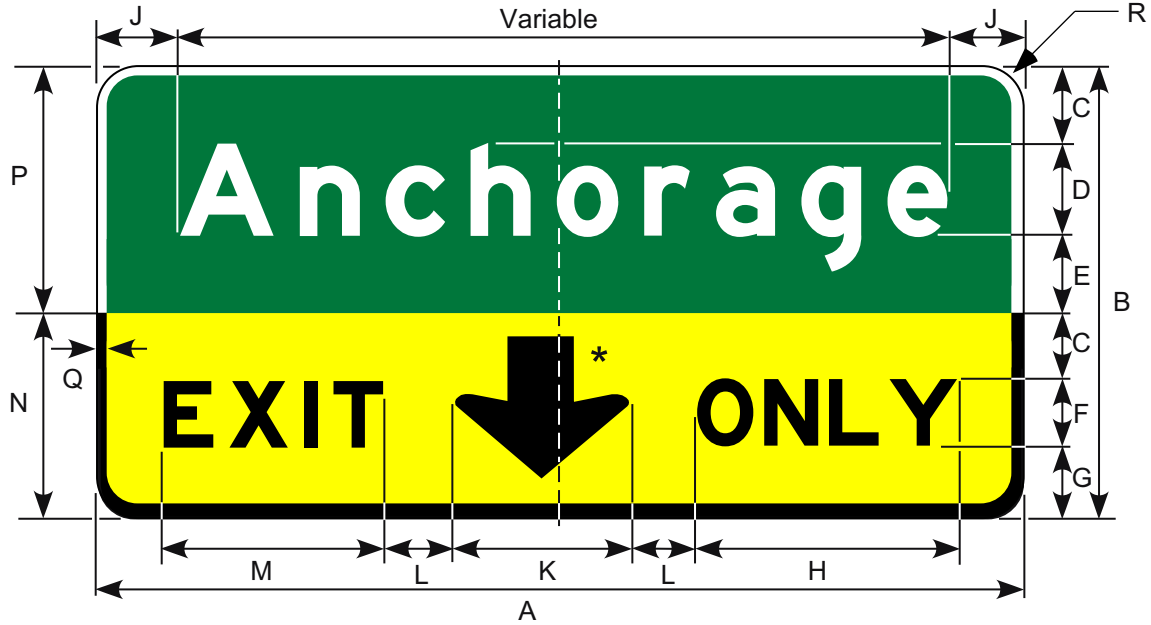

Upper Border and Legend: White
 Lower Border and Legend: Black
 Upper Background: Green
 Lower Background: Yellow

* See Appendix B-3 for Arrow Details.

For Overhead Mounting Only

Letter Size (inches)	Dimensions (inches)															
	A	B	C	D	E	F	G	H	J	K	L	M	N	P	Q	R
16 / 12	138 min	70	10	16/12	8.0	10	16	41	16±	32	8.0	33	36	34	2.0	4.0

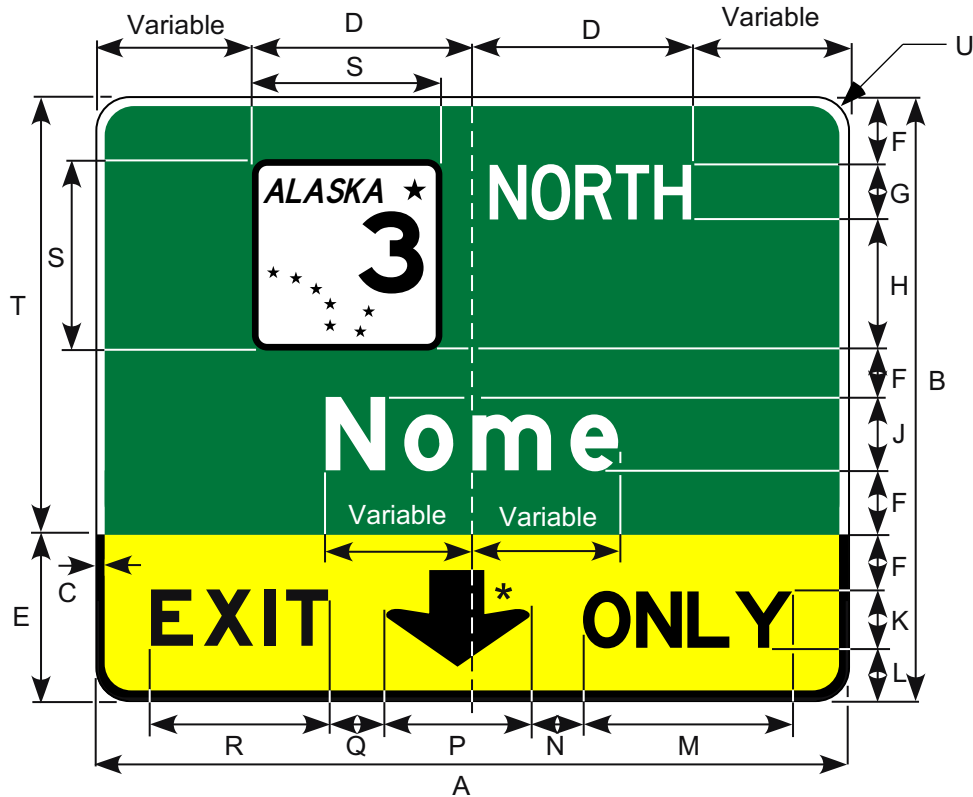

Upper Border and Legend: White
 Lower Border and Legend: Black
 Upper Background: Green
 Lower Background: Yellow
 Marker: Black on White

* See Appendix B-3 for
 Arrow Details.

Make symbol proportional
 to graphic shown

For Overhead Mounting Only

Letter Size (inches)	Dimensions (inches)										
	A	B	C	D	E	F	G	H	J	K	L
16 / 12	138 min.	118	2.0	50	36	10	12D	24	16/12	10D	16
	M	N	P	Q	R	S	T	U			
	41	8.0	32	8.0	33	36	82	4.0			

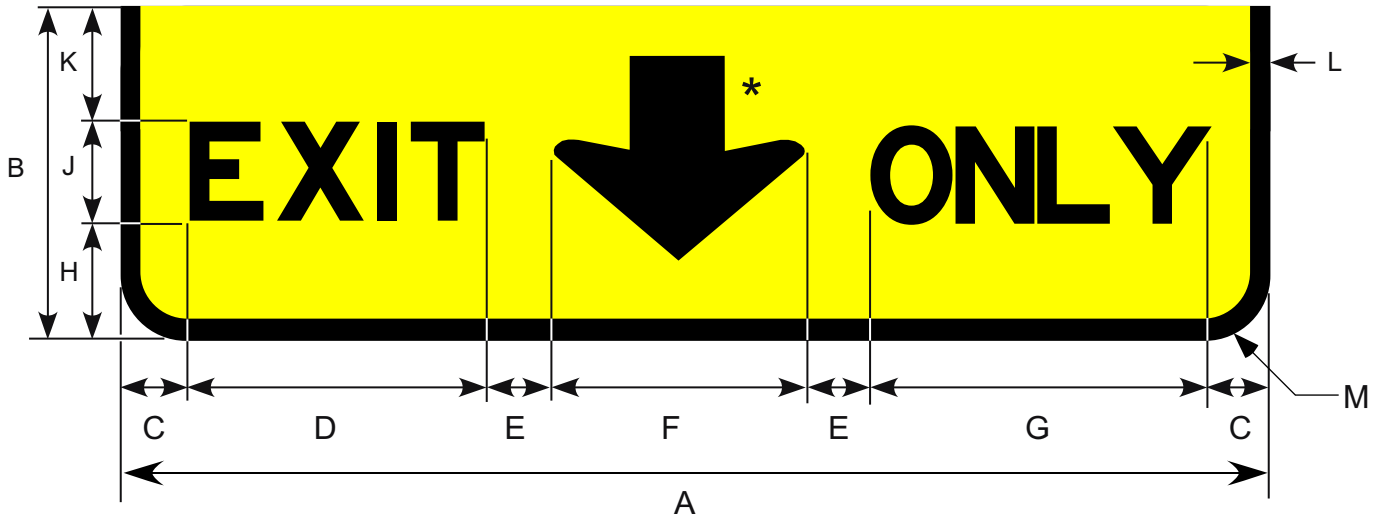

Border and Legend: Black
Background: Yellow

*See Appendix B-3 for Arrow Details.

For Overhead Mounting Only

Letter Size (inches)	Dimensions (inches)											
	A	B	C	D	E	F	G	H	J	K	L	M
10	138	36	8±	33	8.0	32	41	16	10D	10	2.0	4.0
12	168	36	12±	39	12	32	49	14	12D	10	2.0	4.0

EMERGENCY MANAGEMENT SIGNS

EM-2 to EM1-100

EM-2 EM-3

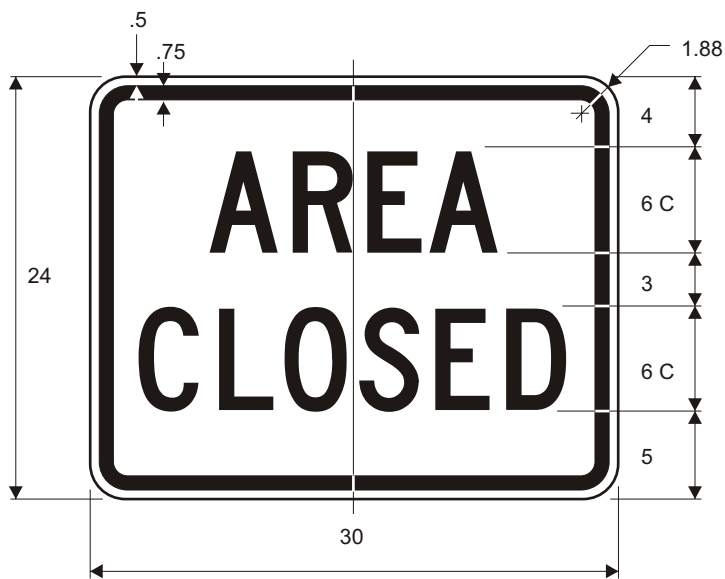

EM-2

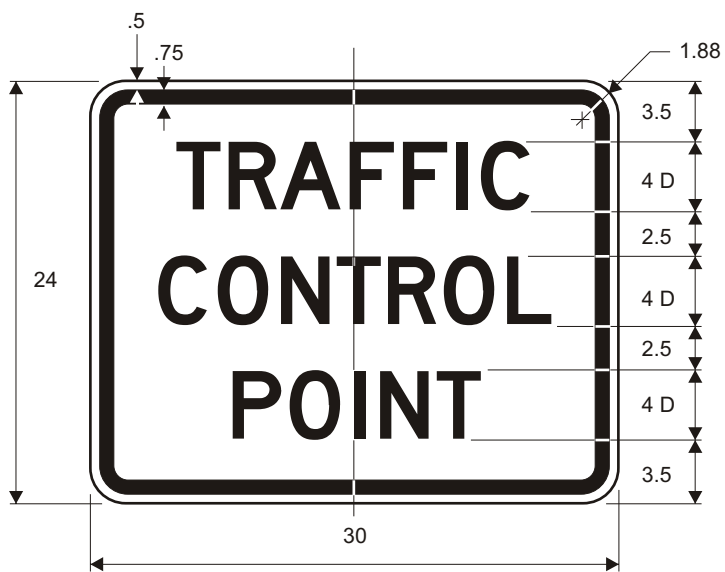

EM-3

Border and Legend: Black
Background: White

EM-4
EM-5



EM-4

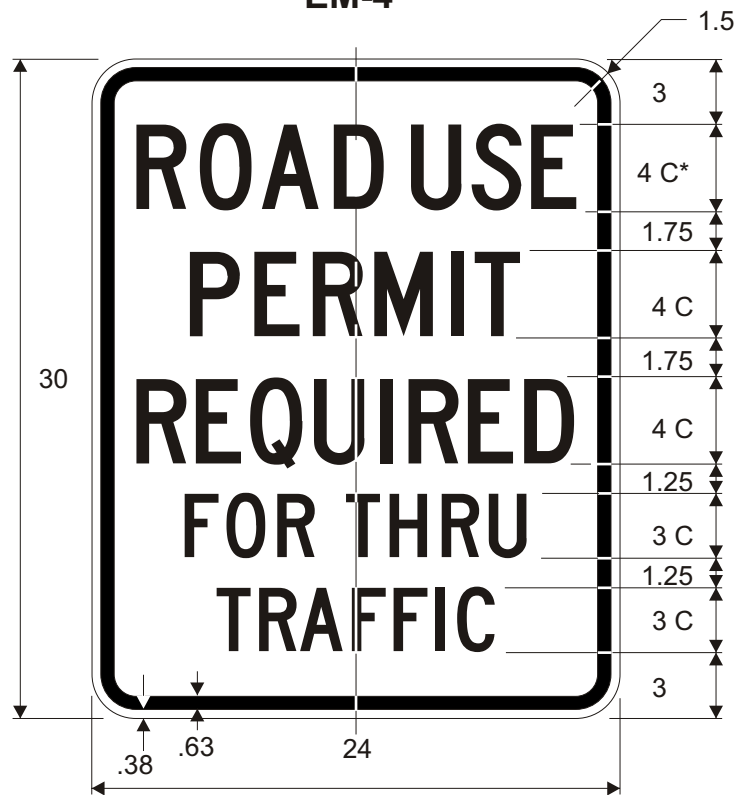

EM-5

*Reduce spacing to fit.

Border and Legend: Black
Background: White

EM-6A

EM-6B

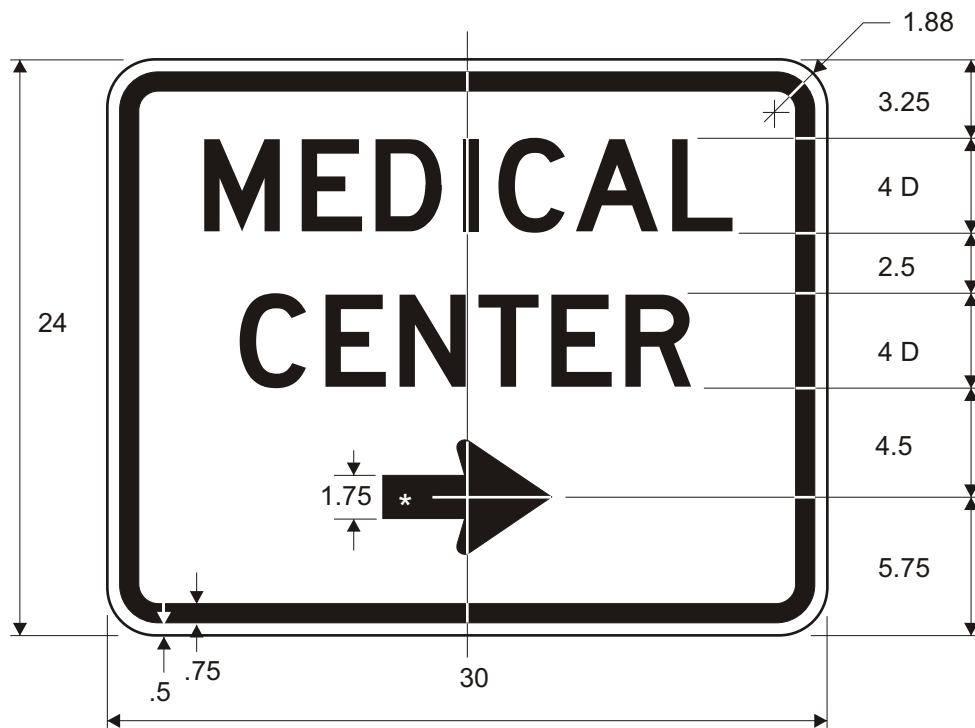

EM-6A



EM-6B

Border and Legend: Black
Background: White

*See Appendix B-1 for Standard Arrow Details.

EM-6C EM-6D



EM-6C

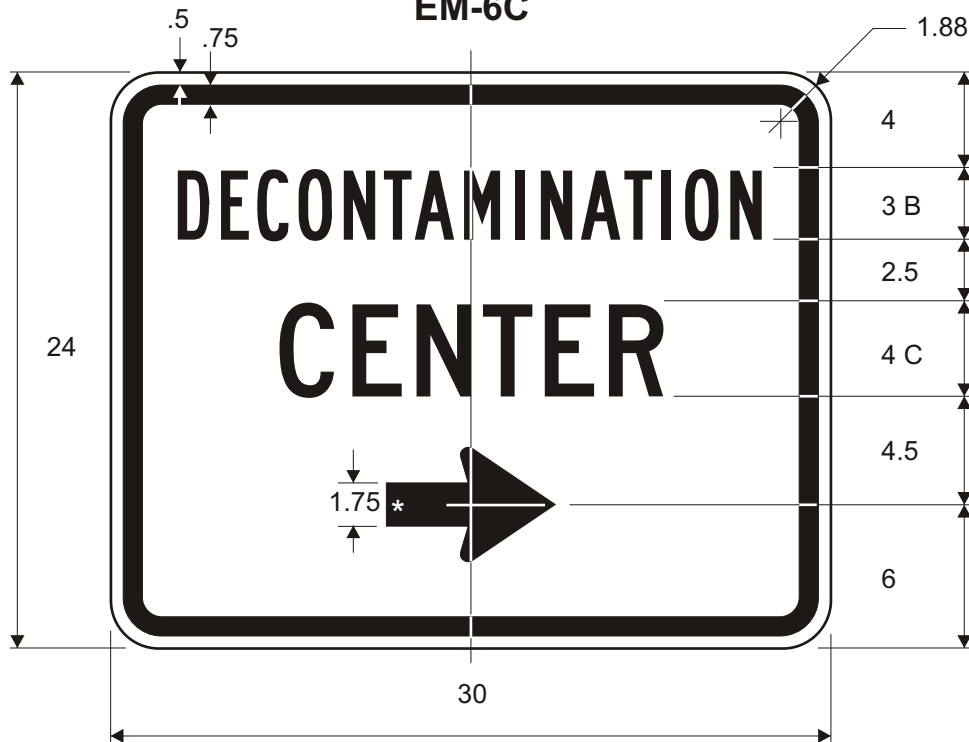

EM-6D

*See Appendix B-1 for Standard Arrow Details.

Border and Legend: Black
Background: White

EM-7A

EM-7B



EM-7A



EM-7B

*See Appendix B-1 for Standard Arrow Details.

Border and Legend: Black
Background: White

EM-7C
EM-7D



EM-7C



EM-7D

Border and Legend: Black
Background: White
CD Emblem: Yellow Triangles Inscribed in
a Black Circle Placed on a Yellow Square

*Reduce spacing to fit
**Optically locate arrow and mileage
characters about vertical centerline.
***See Appendix B-1 for Standard Arrow Details.

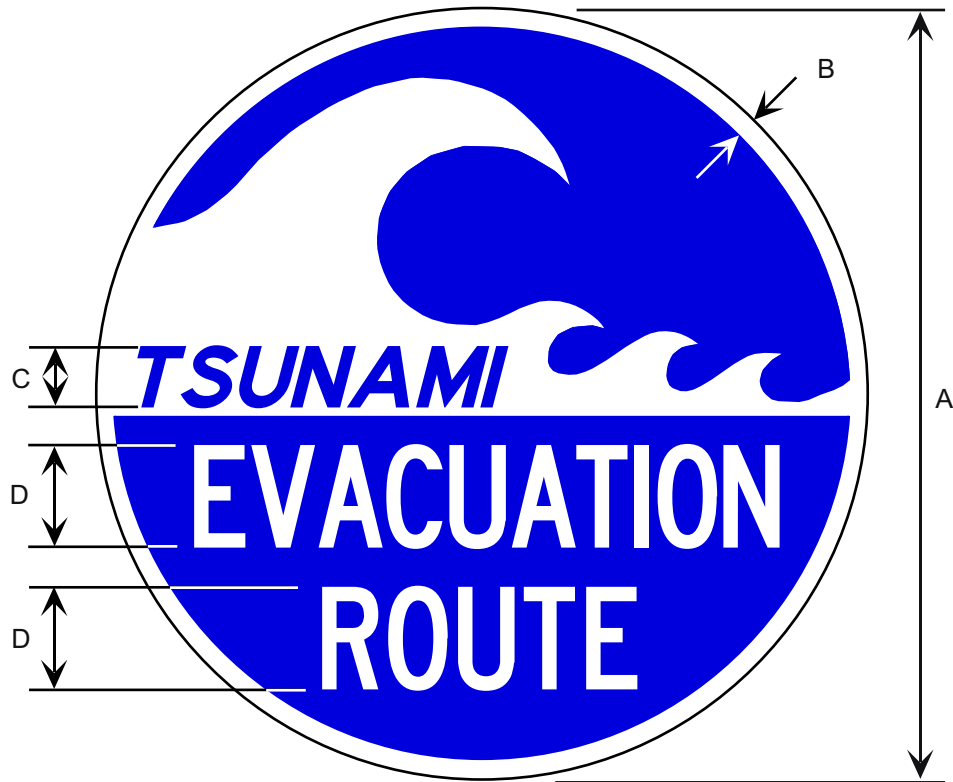

Border and Wave: White
 Background: Blue
 Legend: Blue/White

Make the symbol proportional
 to the one shown

Prior to the 2003 revision of this manual this sign was
 numbered CD-100 and previous to that AK-CD-1A.

Road Class	Dimensions (inches)			
	A	B	C	D
Conv & Min	24	0.63	2.0E Slant	3.0C
Special	36	0.88	2.5E Slant	4.0C

CONSTRUCTION GUIDE SIGNS

G20-1 to G20-4

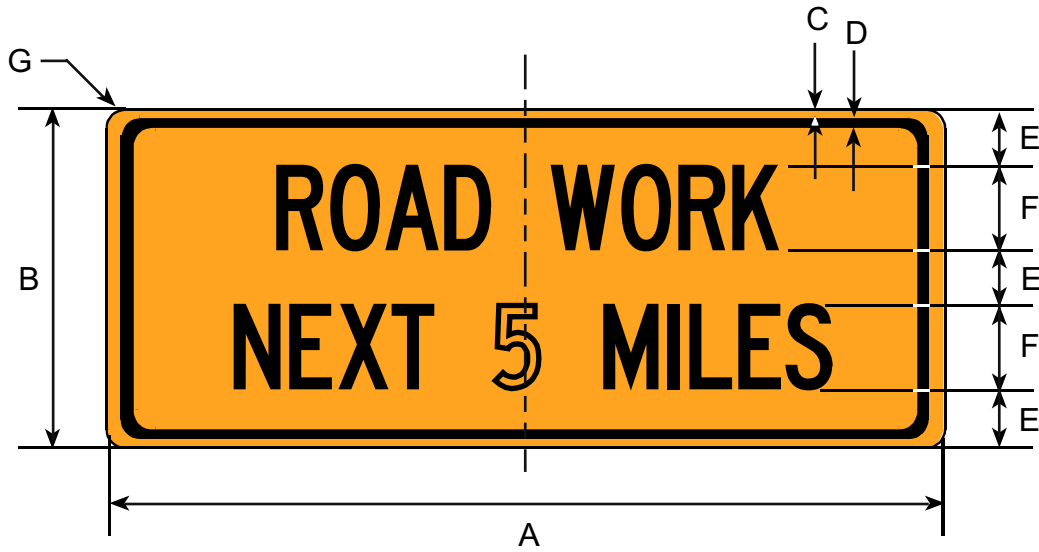

Border and Legend: Black
 Background: Orange

Road Class	Dimensions (inches)						
	A	B	C	D	E	F	G
Conven/ExpwyFwy	60	24	0.63	0.88	4	6C	3

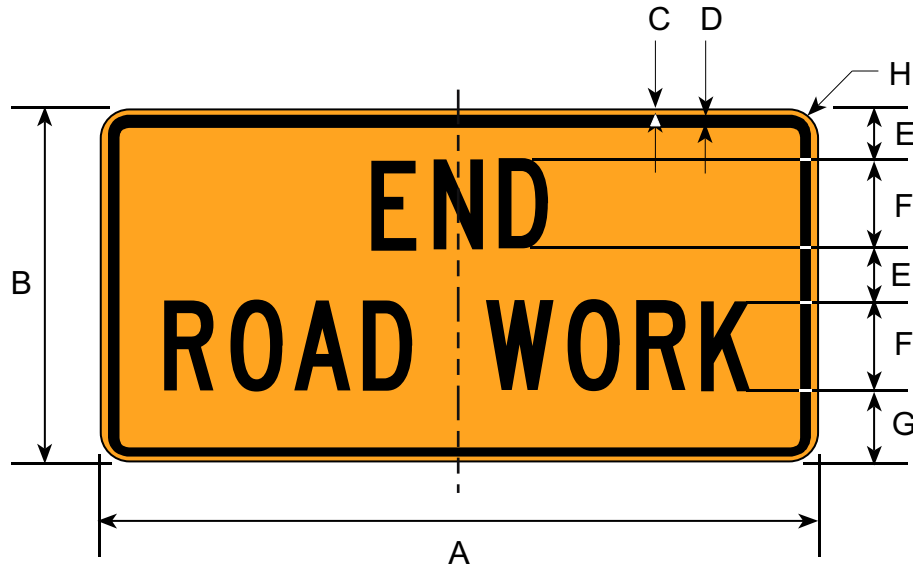

Border and Legend: Black
 Background: Orange

Prior to the 2003 revision of this manual
 this sign was numbered G20-2A.

Road Class	Dimensions (inches)							
	A	B	C	D	E	F	G	H
Conven/ExpwyFwy	48	24	0.38	0.63	3.75	6C	4.5	1.5

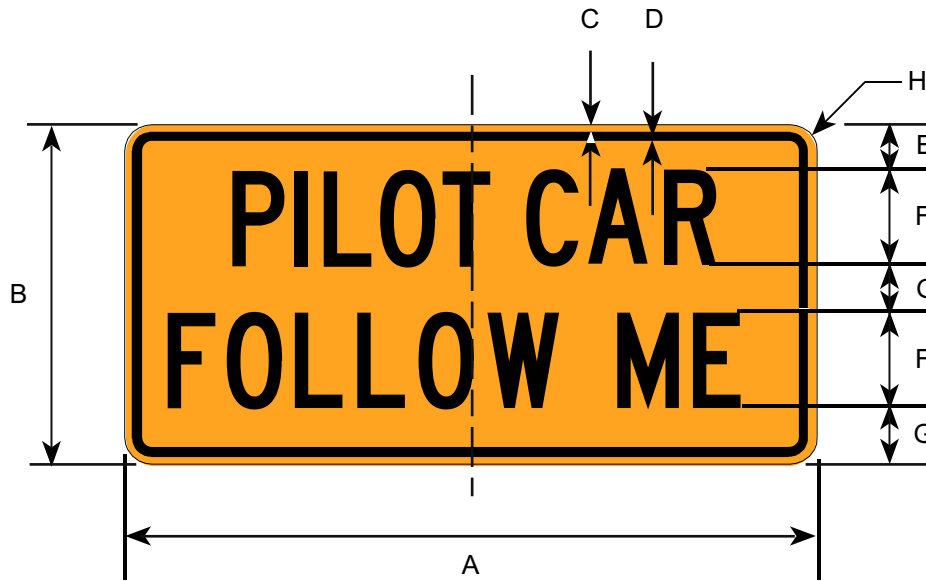

Border and Legend: Black
Background: Orange

Road Class	Dimensions (inches)							
	A	B	C	D	E	F	G	H
Conv & Min	36	18	0.38	0.63	2.5	5C	2.75	1.5

GENERAL INFORMATION SIGNS

I-1 to I-201

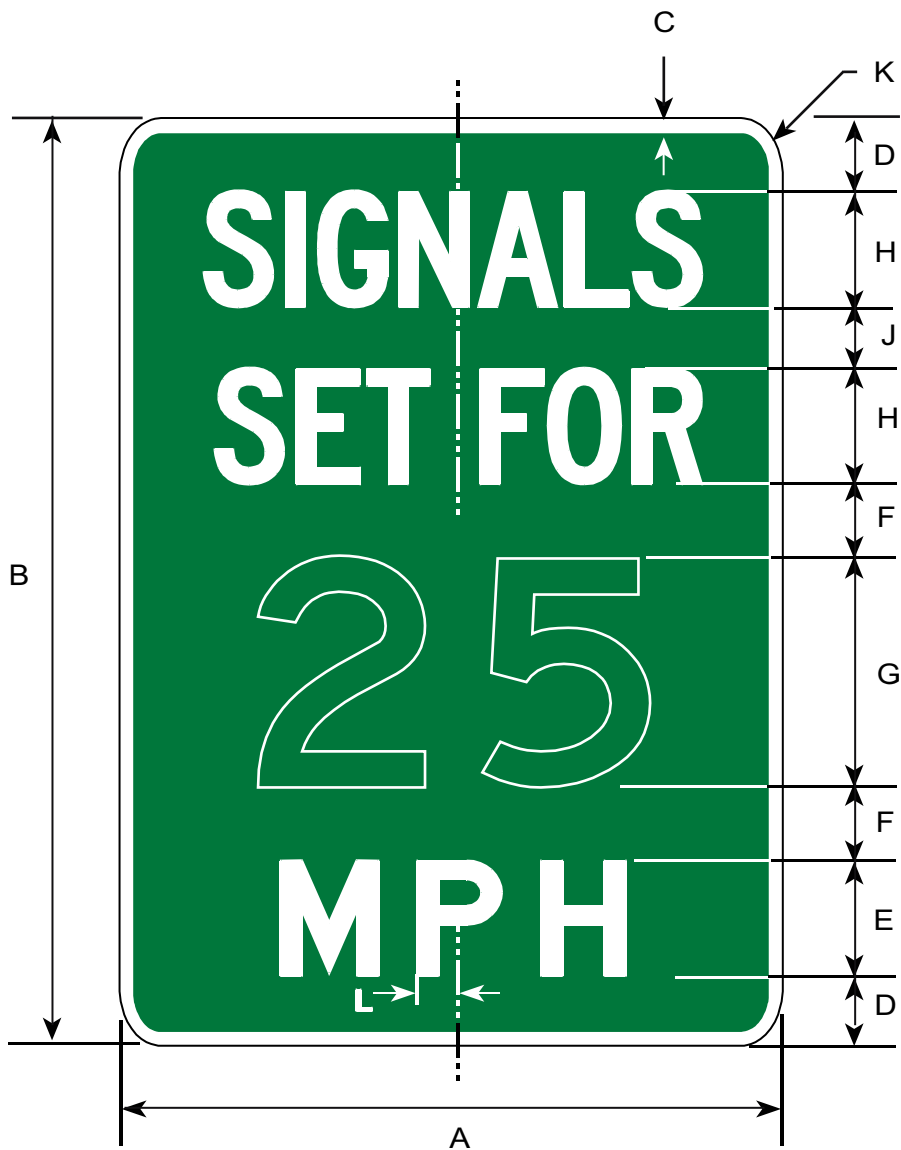

Border and Legend: White
Background: Green

Road Class	Dimensions (inches)										
	A	B	C	D	E	F	G	H	J	K	L
Conv & Min	12	18	0.5	2	2D	1	4D	2C	2	1.5	0.5

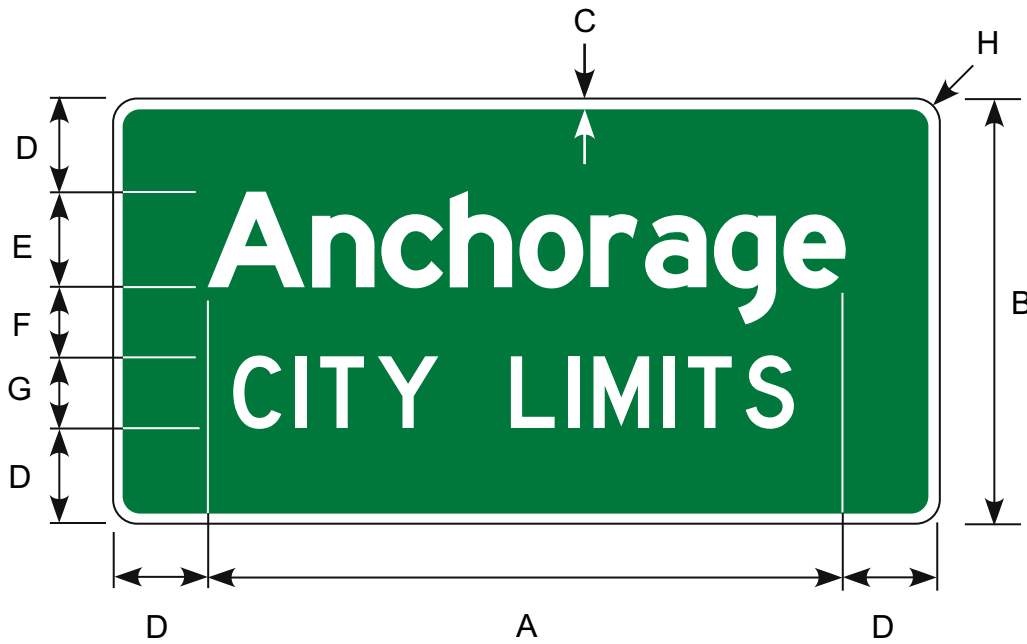

Border and Legend: White
Background: Green

Road Class	Dimensions (inches)								
	A	B	C	D	E	F	G	H	
Conventional	VAR	36	2.0	8±	8/6	6.0	6D	2.25	

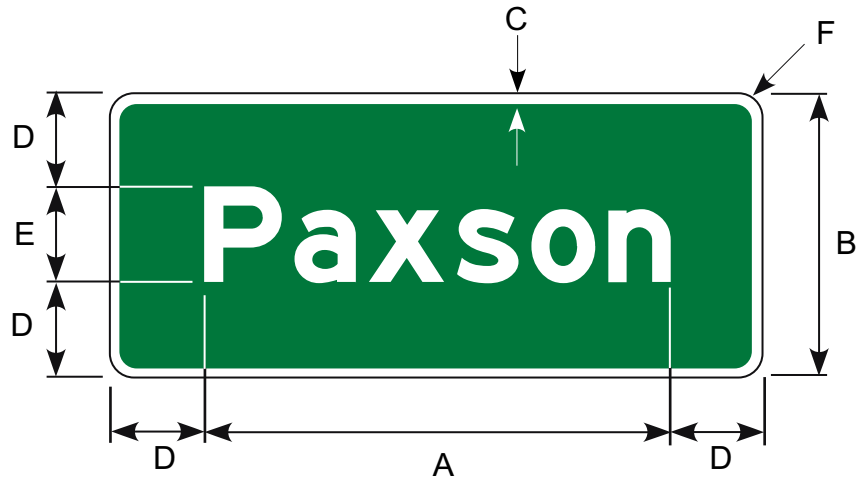

Border and Legend: White
Background: Green

Road Class	Dimensions (inches)					
	A	B	C	D	E	F
Conventional	VAR	24	0.75	8±	8/6	1.5

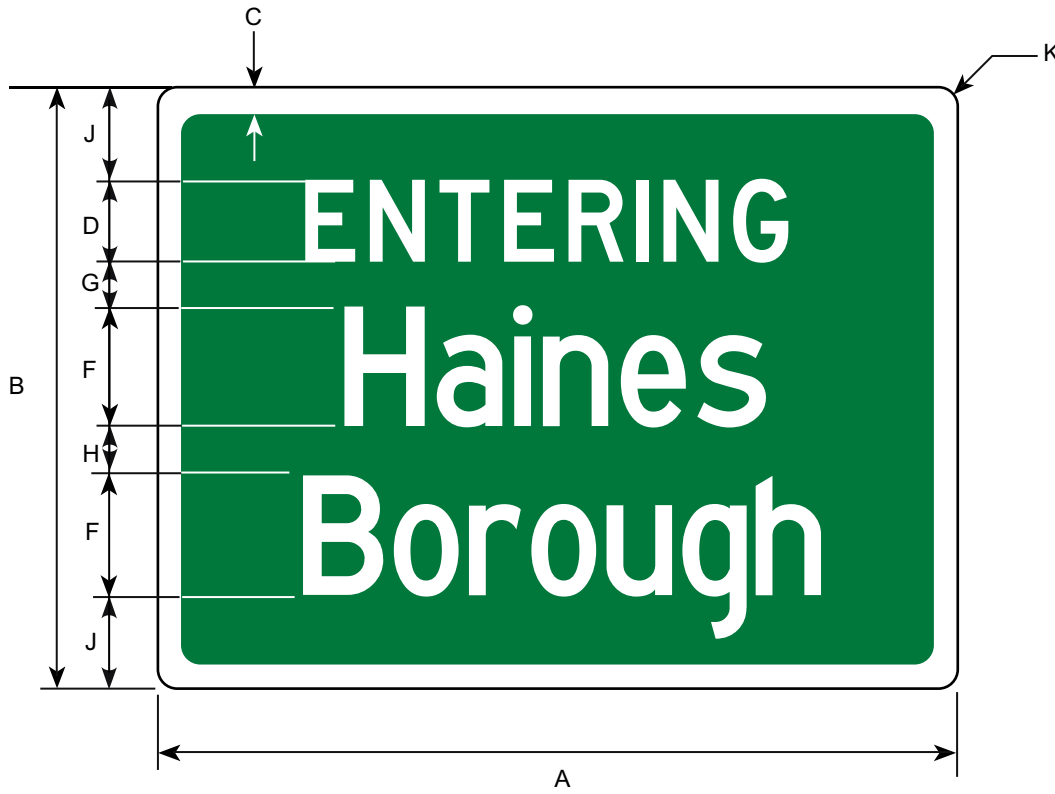

Border and Legend: White
Background: Green

Road Class	Dimensions (inches)								
	A	B	C	D	F	G	H	J	K
Minimum	VAR	30	1.0	4D	6/4.5	3	3	4	1.88
Conventional	VAR	48	1.3	6D	8/6	6	6	7	3.00

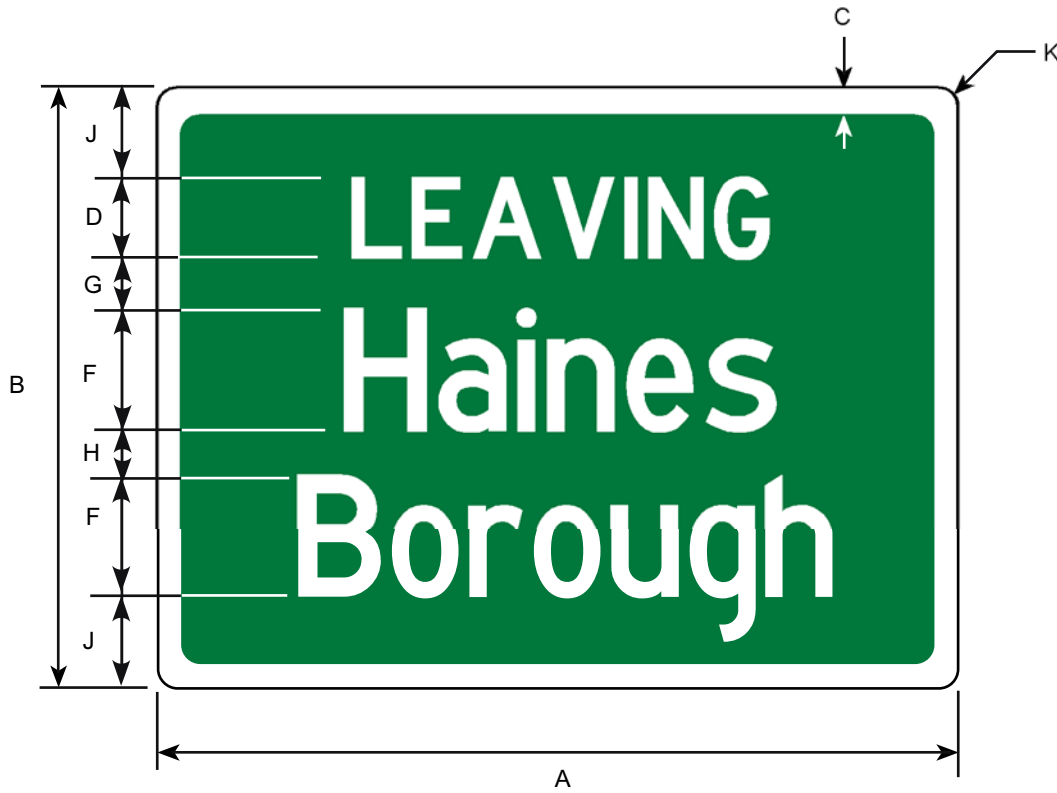

Border and Legend: White
Background: Green

Road Class	Dimensions (inches)								
	A	B	C	D	F	G	H	J	K
Minimum	VAR	30	1.00	4D	6/4.5	3	3	4	1.88
Conventional	VAR	48	1.25	6D	8/6	6	6	7	3.00

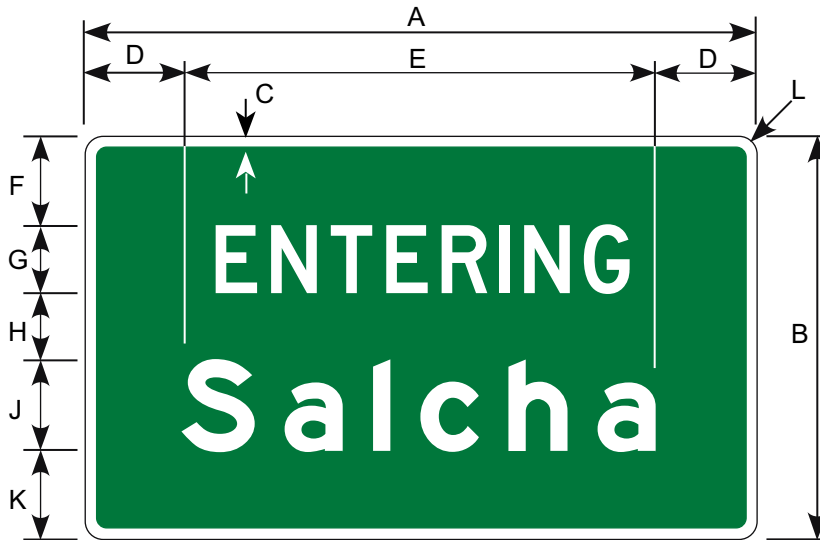

Border and Legend: White
 Background: Green

Road Class	Dimensions (inches)										
	A	B	C	D	E	F	G	H	J	K	L
Conventional	VAR	36	1.0	9±	VAR	8.0	6D	6.0	8/6	8.0	2.5

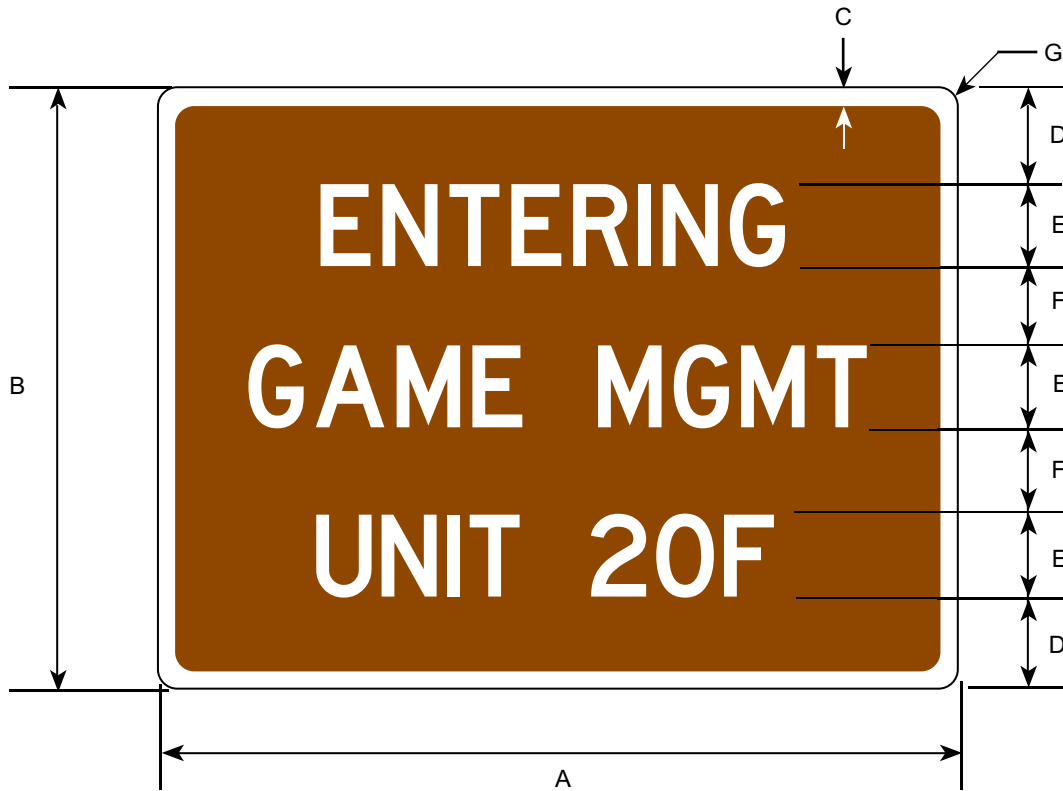

Border and Legend: White
Background: Brown

Road Class	Dimensions (inches)						
	A	B	C	D	E	F	G
Conv & Min	40	36	0.75	6	5D	4.5	2.25



Border and Legend: White
 Background: Brown

Road Class	Dimensions (inches)						
	A	B	C	D	E	F	G
Conv & min	40	36	0.75	6	5D	4.5	2.25



Border and Legend: White
 Background: Green

Road Class	Dimensions (inches)						
	A	B	C	D	F	G	H
Minimum	VAR	24	0.75	6/4.5	4.00	4	1.50
Conventional	VAR	36	1.50	8/6	6.00	7	2.25
Expwy/Fwy	VAR	48	1.50	10.67/8	8.66	9	3.00

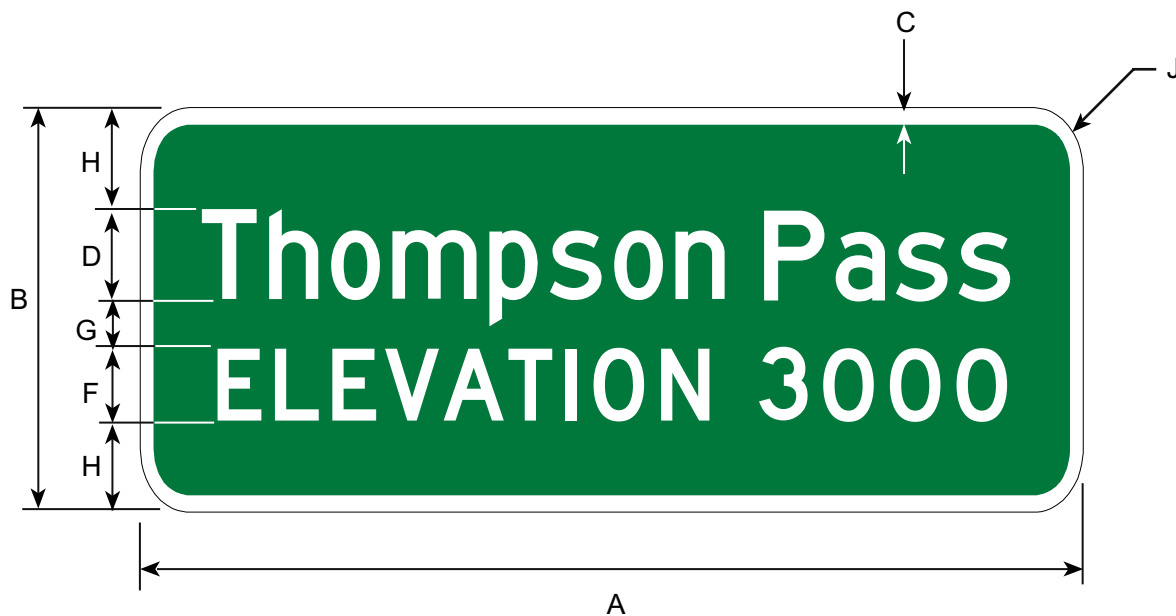

Border and Legend: White
 Background: Green

Road Class	Dimensions (inches)							
	A	B	C	D	F	G	H	J
Minimum	VAR	24	0.75	6/4.5	5D	5	4	1.50
Conventional	VAR	36	1.50	8/6	6D	6	8	2.25



Border and Legend: White
Background: Green

* See Appendix B-1 for Standard Arrow Details.

Name of Trail is variable.

Road Class	Dimensions (inches)															
	A	B	C	D	E	F	G	H	J	K	L	M	N	O	P	
Conv & Min	42	54	13.5	14	10.5	8.0	6.0	4.5	7.5	13	4C	5.0	5.0	6.0	7.0	
Expwy/Fwy	54	72	18.0	18	14.0	10.63	8.0	6.0	10	18	6C	6.0	6.0	9.0	9.0	
	Q	R	S	T	U	V	W									
	0.88	0.63	2.25	14	14	2.0	12									
	1.25	0.75	3.0	21	21	3.0	18									

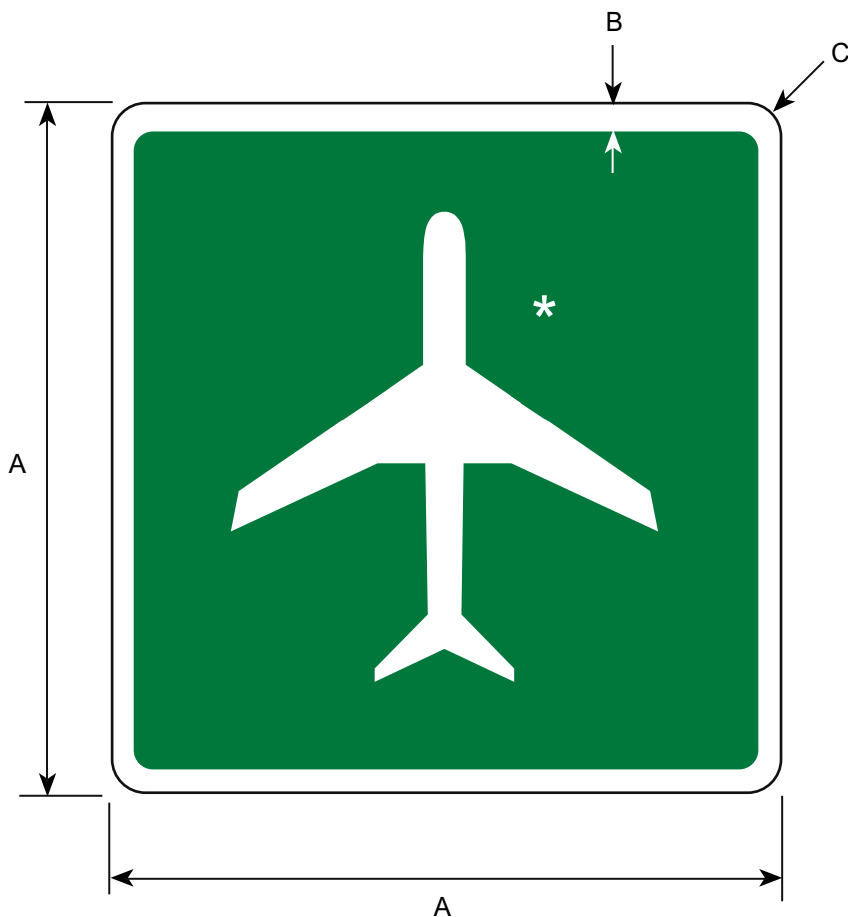

*Make the symbol proportional to the graphic shown.

Border and Legend: White
Background: Green

Rotate as appropriate to indicate direction to airport.

Road Class	Dimensions (inches)		
	A	B	C
Minimum	24	0.50	1.50
Conventional	30	0.75	1.88

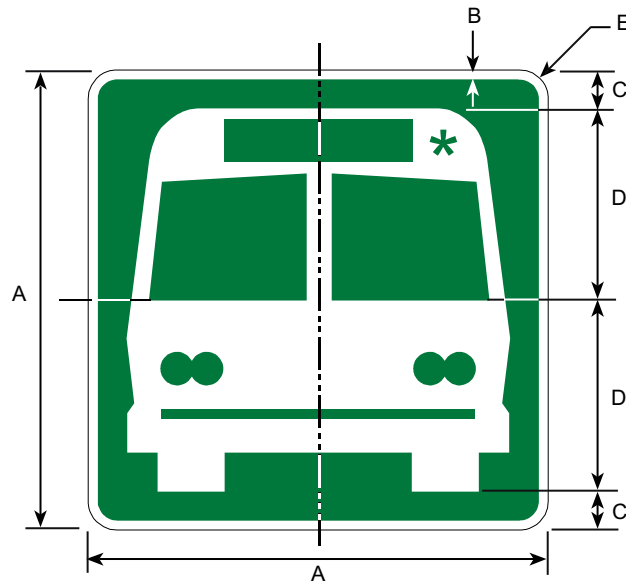

*Make the symbol proportional to the graphic shown.

Border and Legend: White
Background: Green

Road Class	Dimensions (inches)				
	A	B	C	D	E
Minimum	24	0.50	3.00	9.00	1.50
Conventional	30	0.75	3.75	11.25	1.88

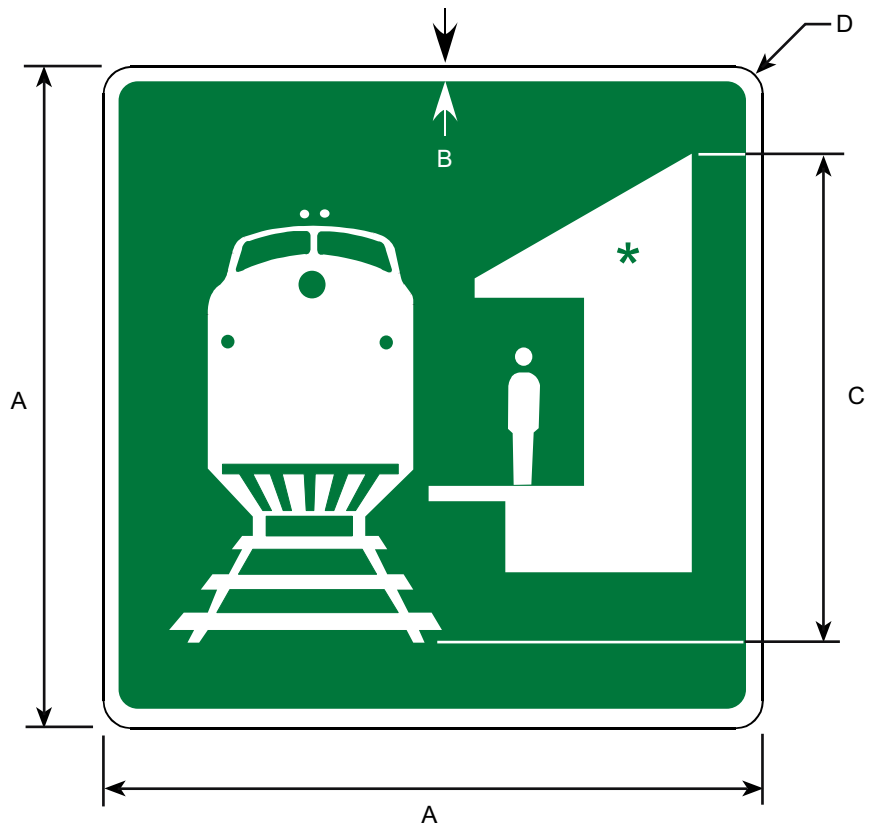

*Make symbol proportional to the graphic shown.

Border and Legend: White
Background: Green

Road Class	Dimensions (inches)			
	A	B	C	D
Minimum	24	0.5	18.0	1.5
Conventional	30	0.75	22.5	1.88

**I-8
I-8P**

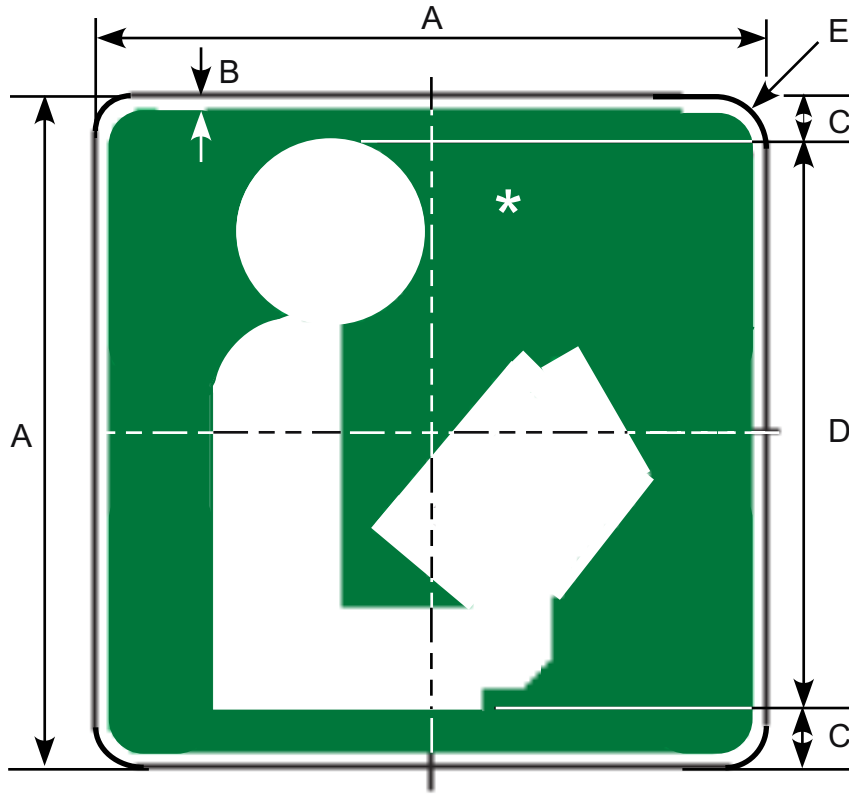

I-8

Road Dimensions (inches)

Class	A	B	C	D	E
Minimum	18	0.50	1.5	15	1.50
Conventional	24	0.50	2.0	20	1.50
Expressway	30	0.75	2.5	25	1.88

Border and Legend: White * Make symbol proportional to the one shown.
Background: Green

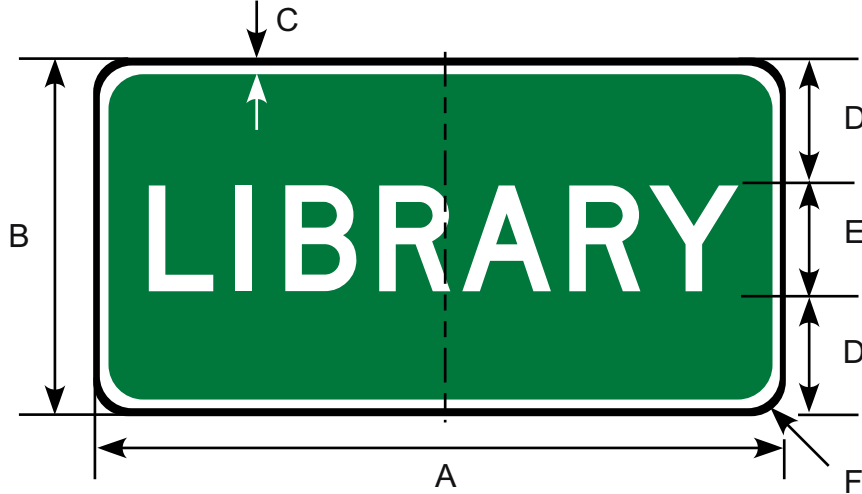

I-8P

Road Dimensions (inches)

Class	A	B	C	D	E	F
Minimum	18	9	0.5	3	3D	1.5
Conventional	24	12	0.5	4	4C	1.5
Expressway	30	15	0.75	5	5C	1.88



Border and Legend: White
Background: Green

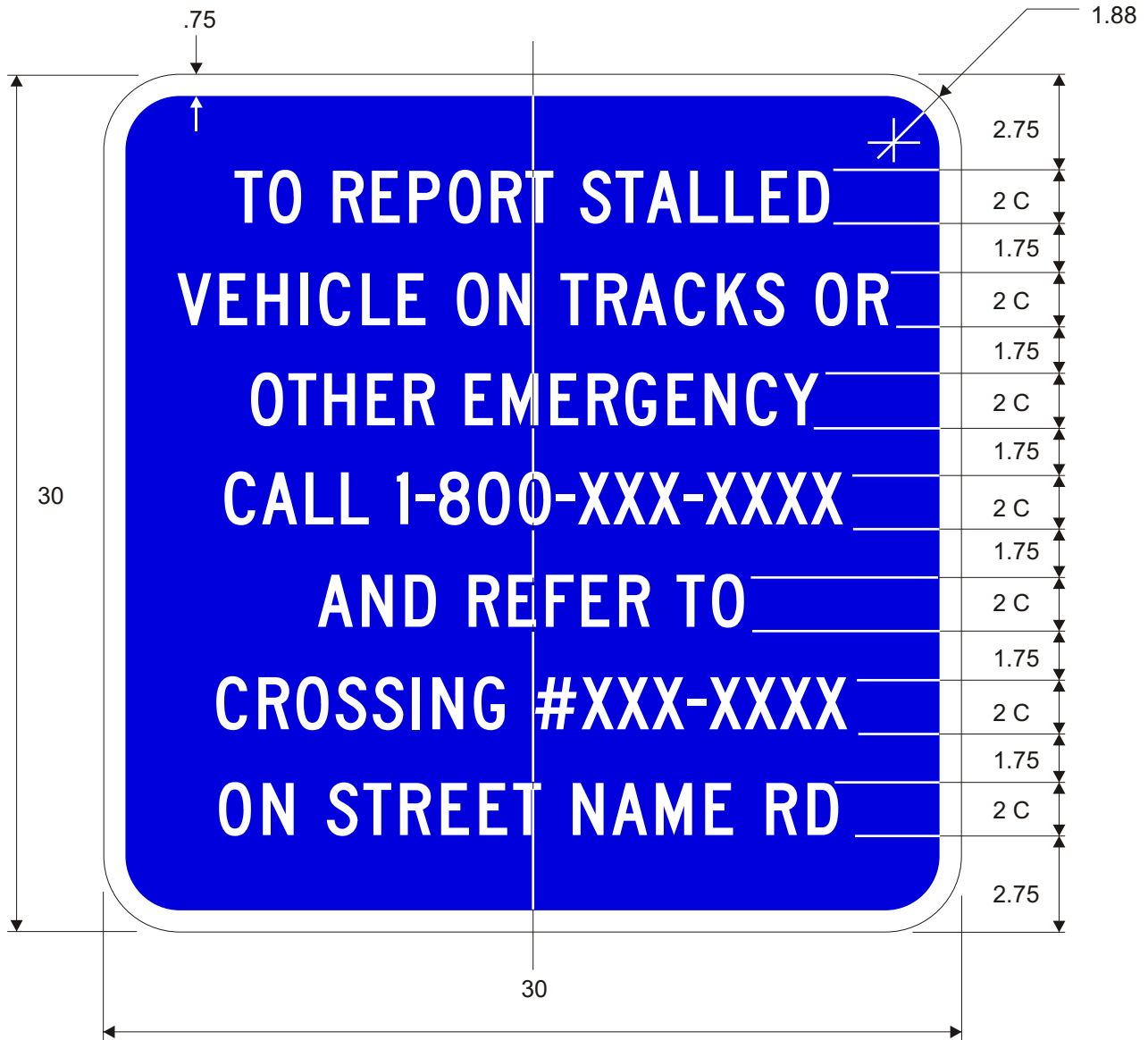

Border and Legend: White
Background: Blue

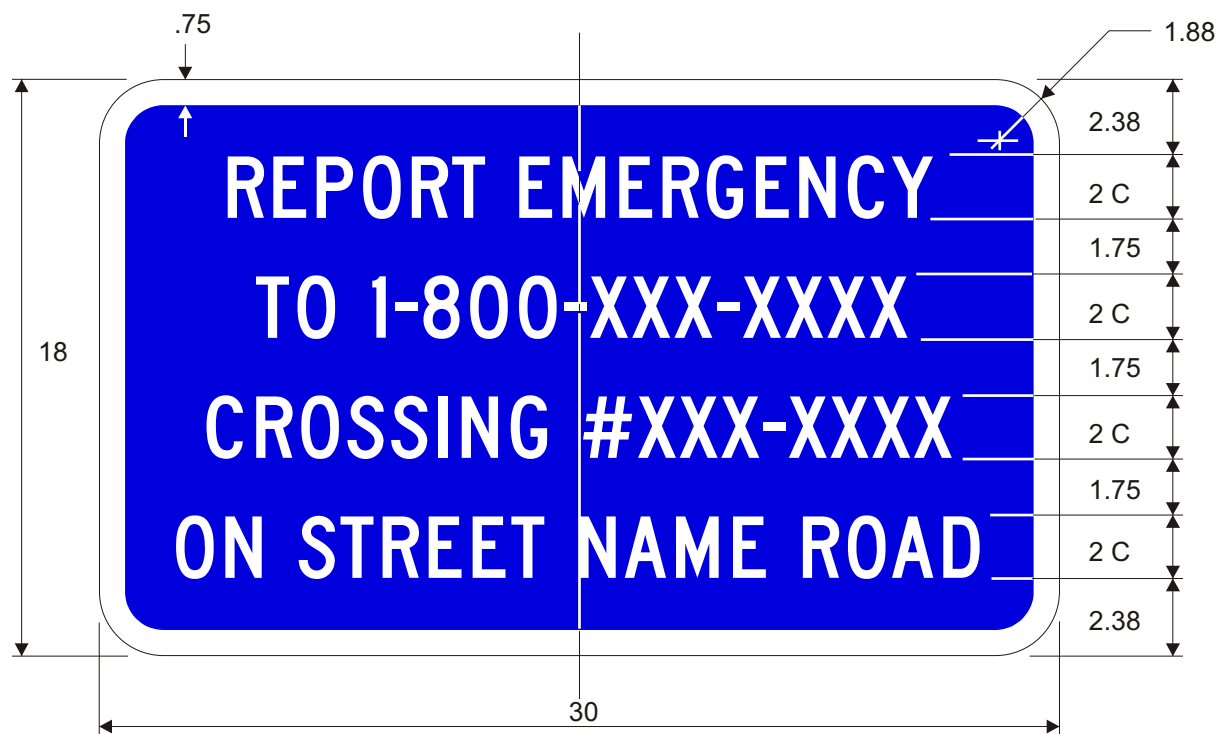

Border and Legend: White
Background: Blue

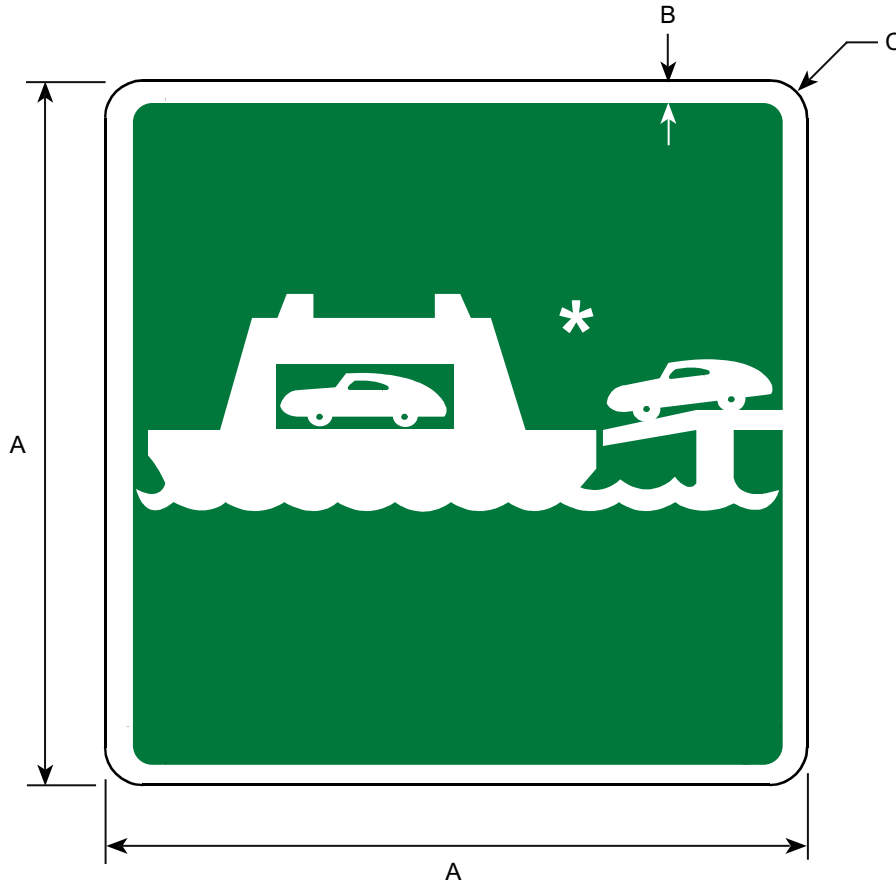

*Make symbol proportional to graphic shown.

Border and Legend: White
Background: Green

Prior to 2002 publication of this manual, this sign was numbered I-08.

Dimensions (inches)			
Road Class	A	B	C
Minimum	24	0.50	1.50
Conventional	30	0.75	1.88



Border and Legend: White
 Background: Green

Road Class	Dimensions (inches)								
	A	B	C	D	E	F	G	H	J
Conventional	VAR	36	2.0	8±	6D	6.0	8/6	51.5	2.25

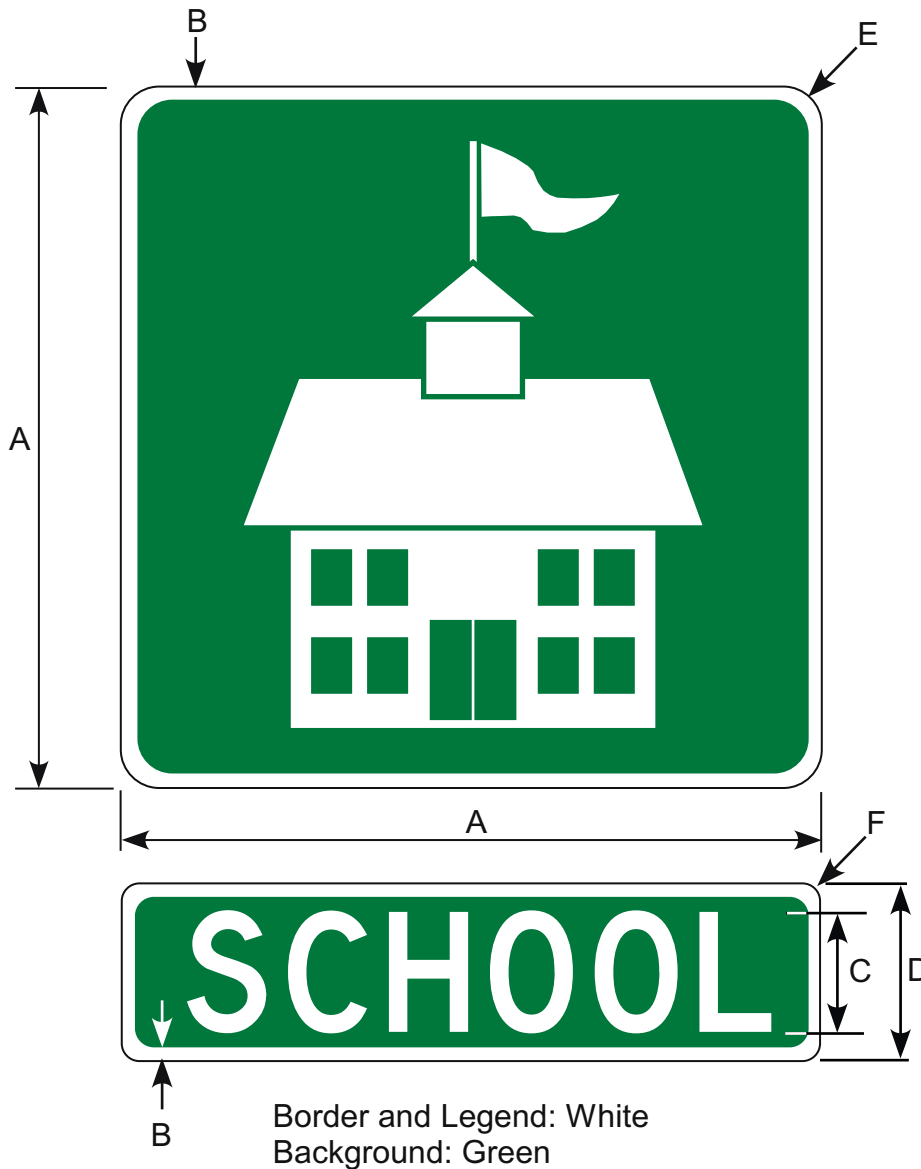

Make symbol proportional to graphic shown

If school names are shown instead of "SCHOOL" on the plate, use 4" Series C letters until the plate exceeds the width of the symbol sign. At greater widths, use 4" Series B. One, two, and three line signs should be 12", 18", and 24" high, respectively for both minimum and conventional road classes.

Road Class	Dimensions (inches)					
	A	B	C	D	E	F
Min	24	0.50	5C	12	1.5	0.50
Conv	30	0.75	6C	12	1.88	0.75

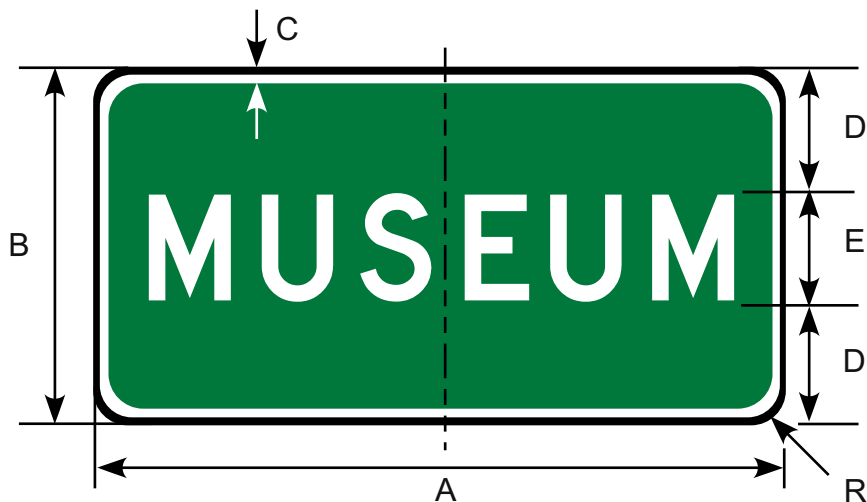

Border and Legend: White
 Background: Green or Brown

Road	Dimensions (inches)					
Class	A	B	C	D	E	R
Conv & Min	24	12	0.50	4.0	4C	1.5

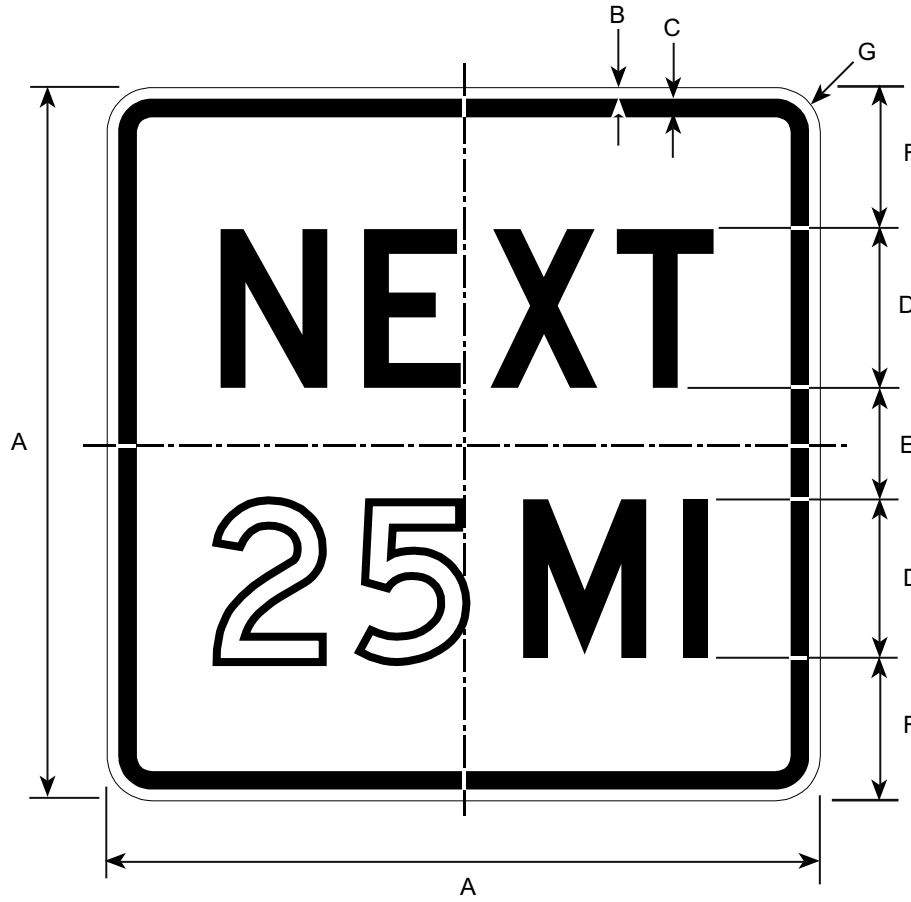

Border and Legend: Black
Background: White

Road Class	Dimensions (inches)						
	A	B	C	D	E	F	G
Min & Conv	18	0.38	0.5	4D	3	3.5	1.5

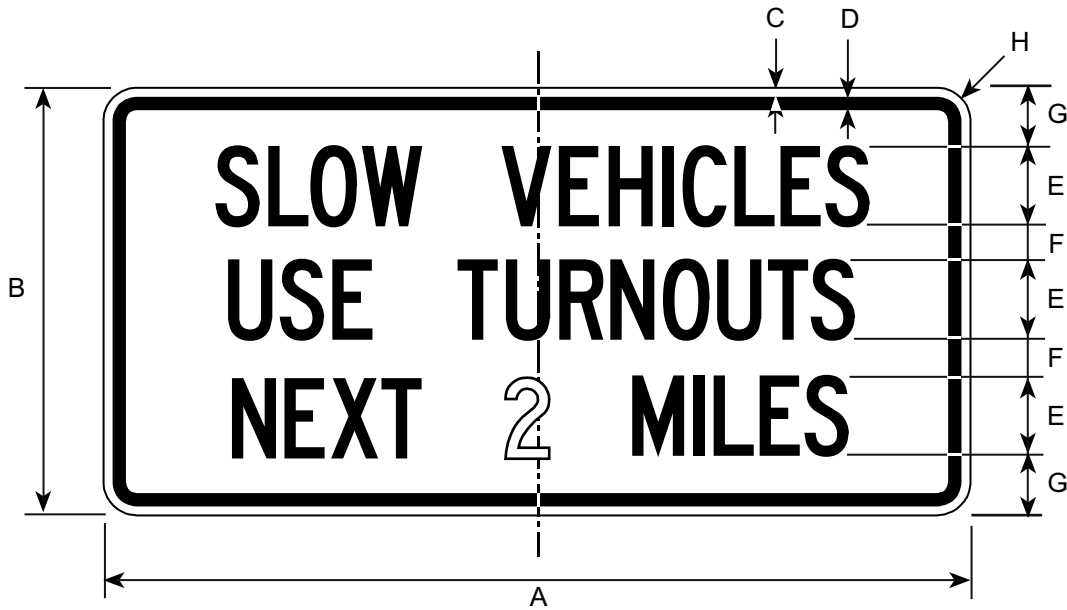

Border and Legend: Black
 Background: White

Prior to 2002 publication of this manual,
 this sign was numbered D9-22B.

Road Class	Dimensions (inches)							
	A	B	C	D	E	F	G	H
Min & Conv	72	36	0.75	1.25	6C	4	5	2.25

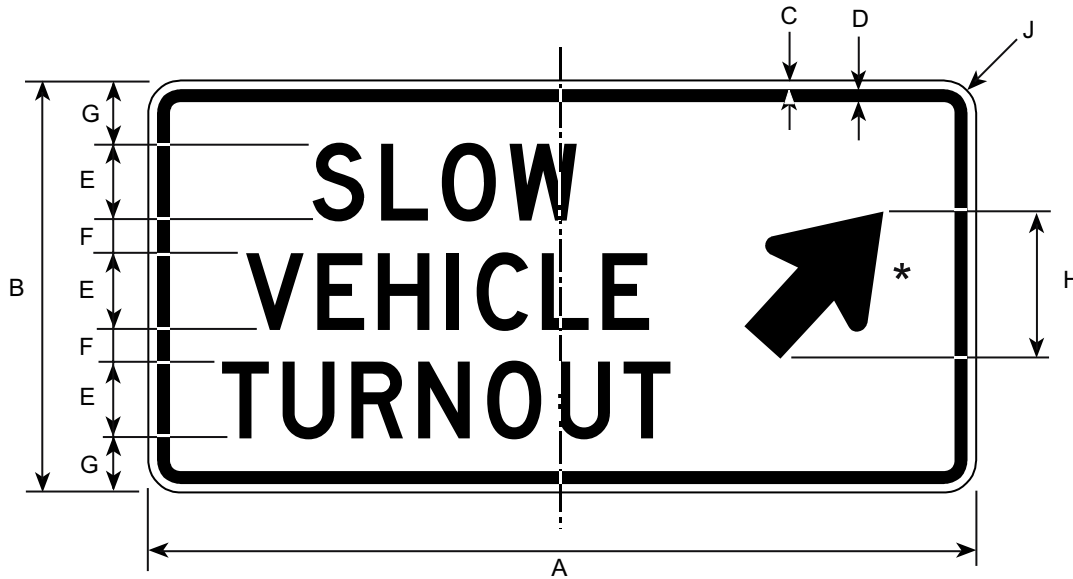

Border and Legend: Black
Background: White

* See Appendix B-4 for Arrow Details.

Prior to 2002 publication of this manual,
this sign was numbered D9-22A.

Road Class	Dimensions (inches)									
	A	B	C	D	E	F	G	H	J	
Min & Conv	72	36	0.75	1.25	6D	4.0	5.0	10.31	2.25	

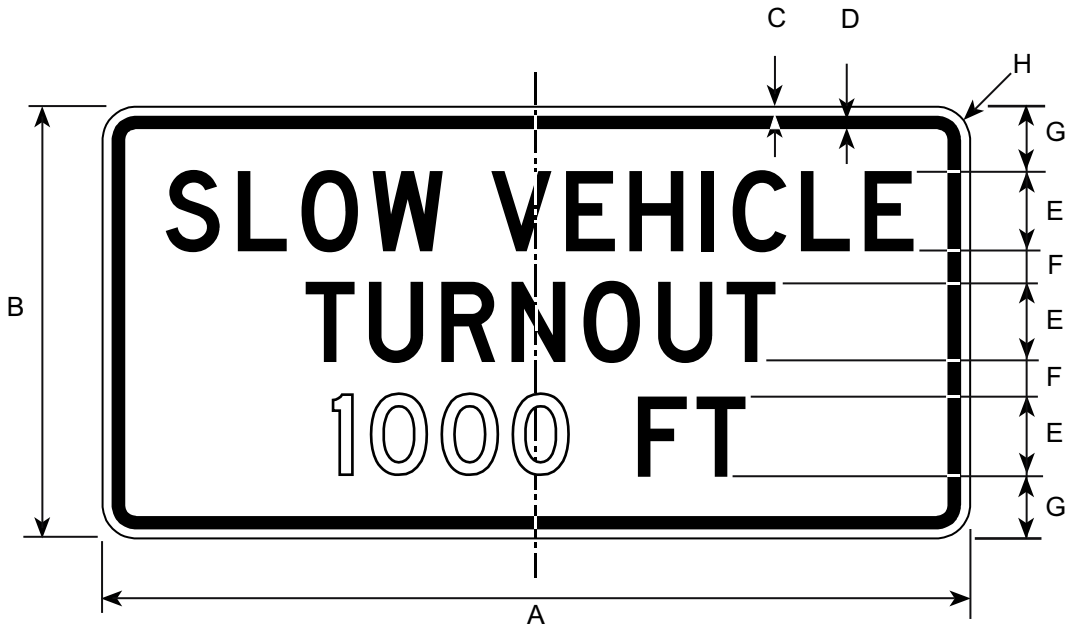

Border and Legend: Black
Background: White

Prior to 2002 publication of this manual,
this sign was numbered D9-22.

Road Class	Dimensions (inches)							
	A	B	C	D	E	F	G	H
Min & Conv	72	36	0.75	1.25	6D	4	5	2.25

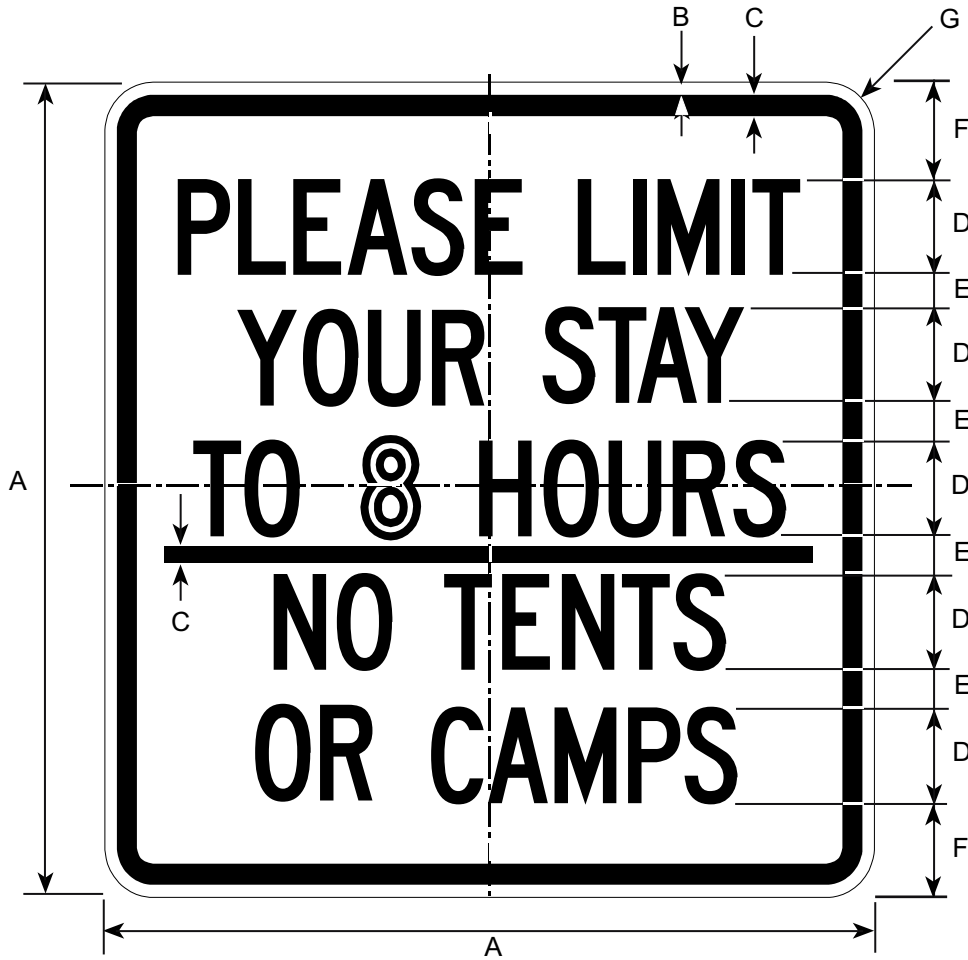

Border and Legend: Black
Background: White

Road Class	Dimensions (inches)						
	A	B	C	D	E	F	G
Min & Conv	36	0.38	0.63	4C	2	4	2.25

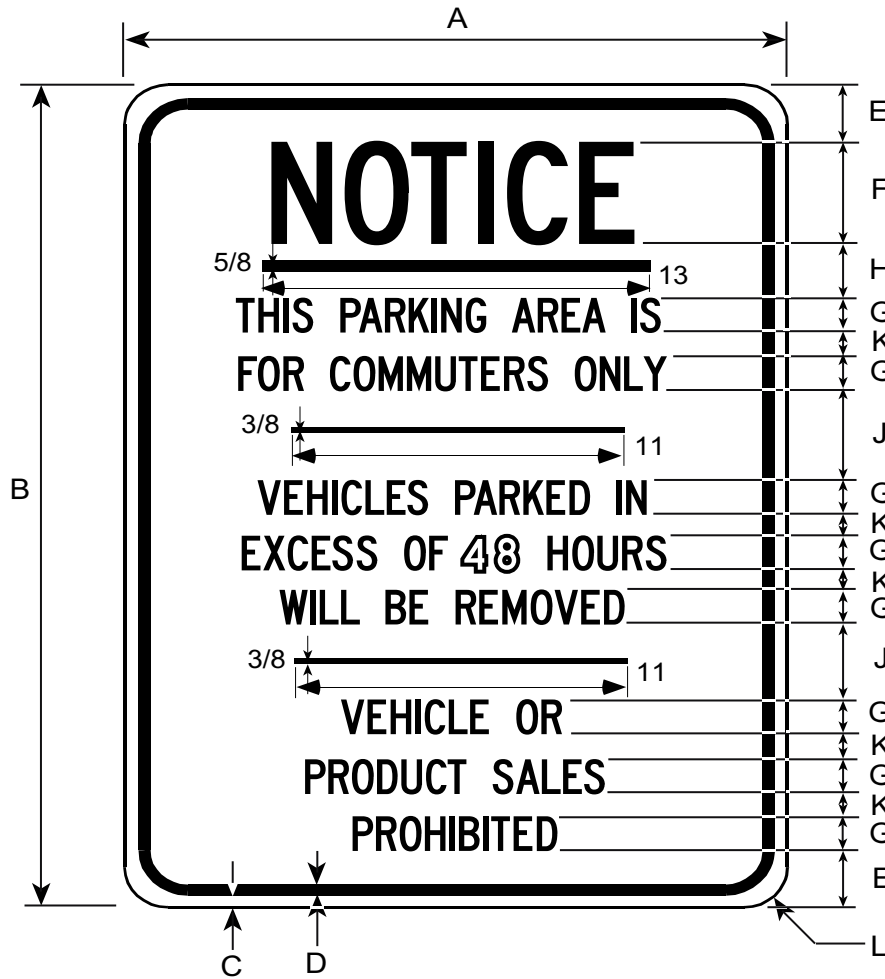

Border and Legend: Black
Background: White

Road Class	Dimensions (inches)										
	A	B	C	D	E	F	G	H	J	K	L
Min & Con	18	24	0.38	0.63	2.0	3C	1C	2.0	1.5	0.8	1.5

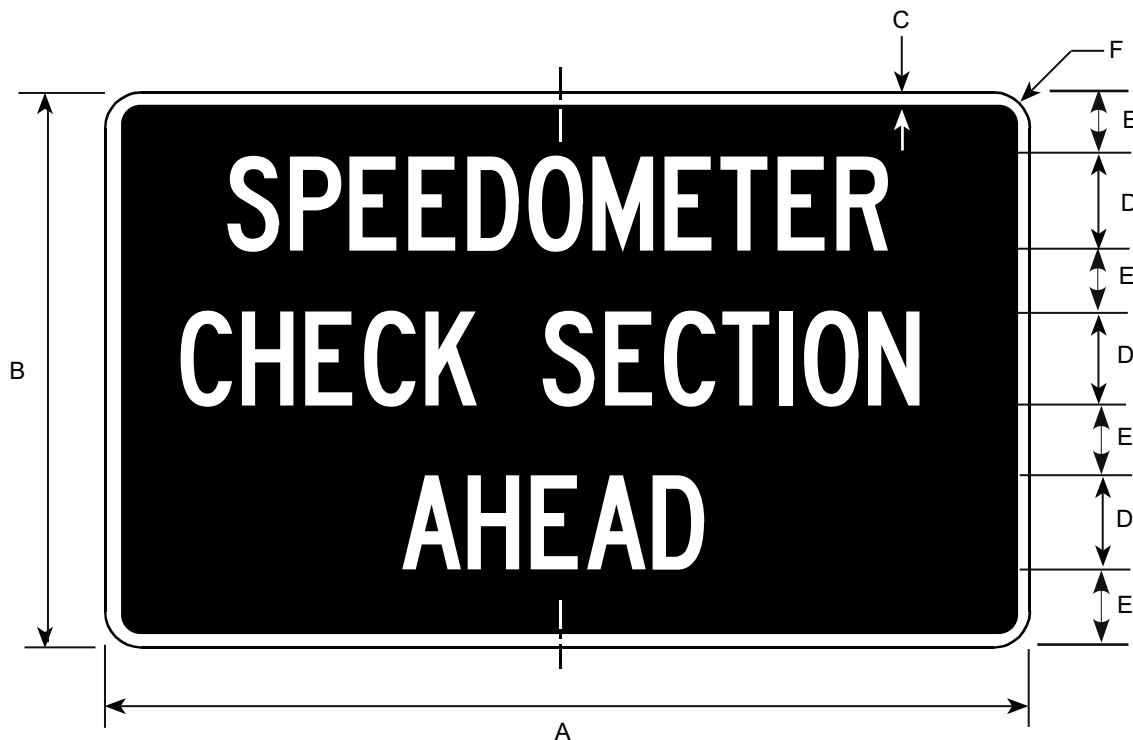

Border and Legend: White
 Background: Black

Road Class	Dimensions (inches)					
	A	B	C	D	E	F
Min & Conv	60	36	2	6C	4.5	2.25

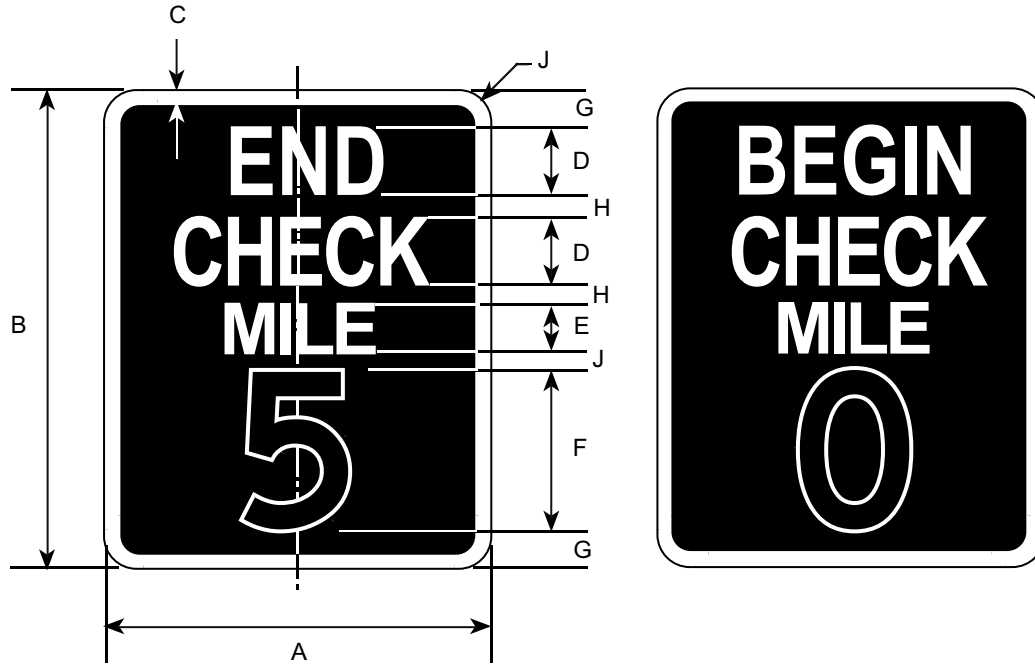

I-141E

I-141B

Border and Legend: White
Background: Black

Prior to the 2002 publication of this manual,
I-141E was M9-3 and I-141B was M9-1.

Miles are variable

Road Class	Dimensions (inches)									
	A	B	C	D	E	F	G	H	J	
Min & Conv	24	30	0.50	4D	3D	10D	2.0	1.75	1.5	

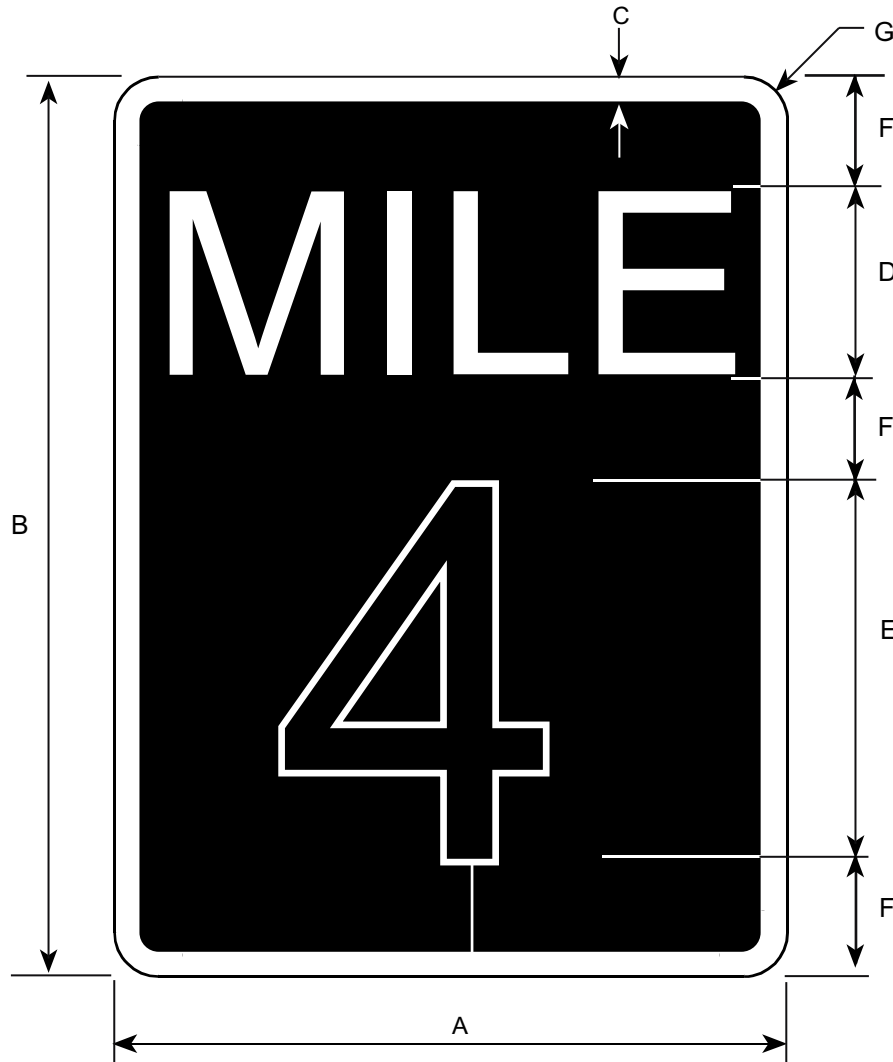

Border and Legend: White
Background: Black

Prior to the 2002 publication of this manual,
this sign was numbered M9-2.

Road Class	Dimensions (inches)						
	A	B	C	D	E	F	G
Min & Conv	18	24	0.5	5D	10D	3	1.5



This drawing has been replaced with:
 I-150
 ADOPT A HIGHWAY
 (08/04/09).

Click on the drawing number in the
 upper right corner to go to the Interim
 Addenda web page.

Border and Legend: White
 Background: Blue

Road Class	Dimensions (inches)									
	A	B	C	D	E	F	G	H	J	
Minimum	24	18	12	0.75	3C	3.0	2	3C	1.5	
Conventional	30	24	12	0.75	4C	4	2	3C	2	

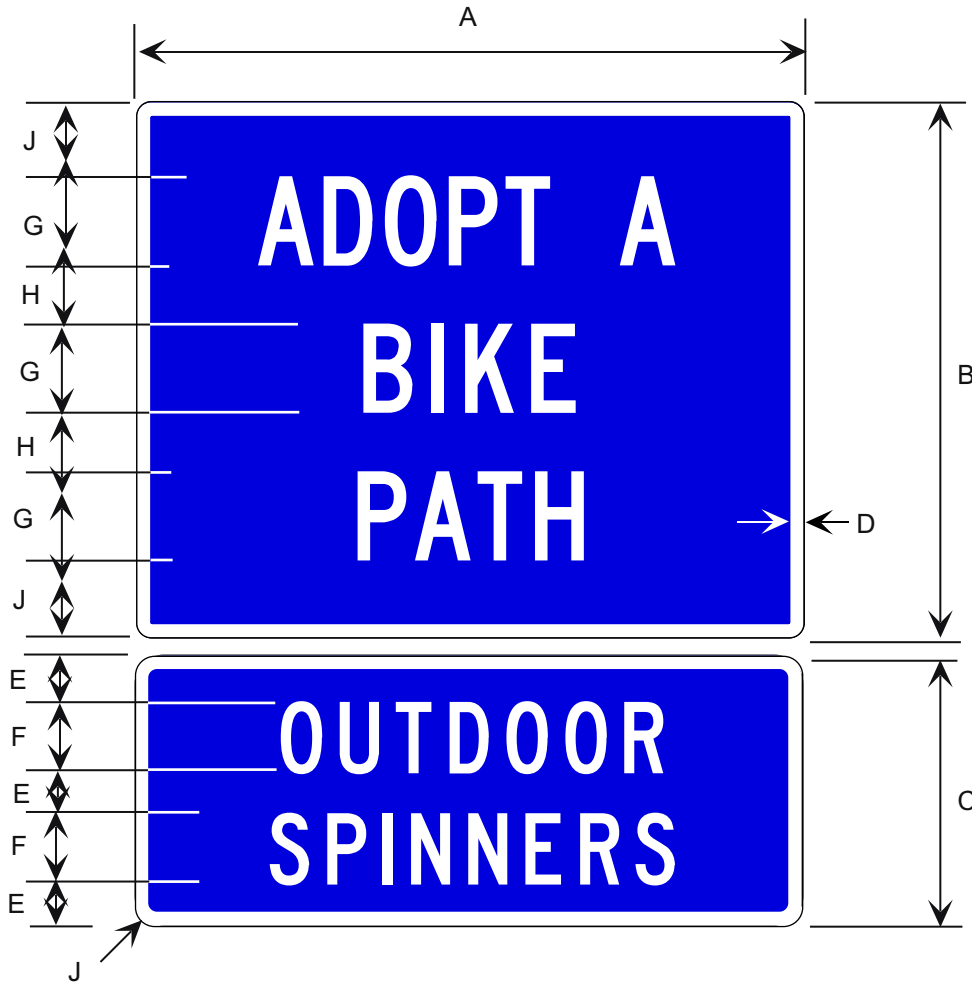

Border and Legend: White
Background: Blue

Road Class	Dimensions (inches)								
	A	B	C	D	E	F	G	H	J
Minimum	24	18	12	0.75	2	3C	3C	3.0	1.5
Conventional	30	24	12	0.75	2	3C	4C	3.5	2

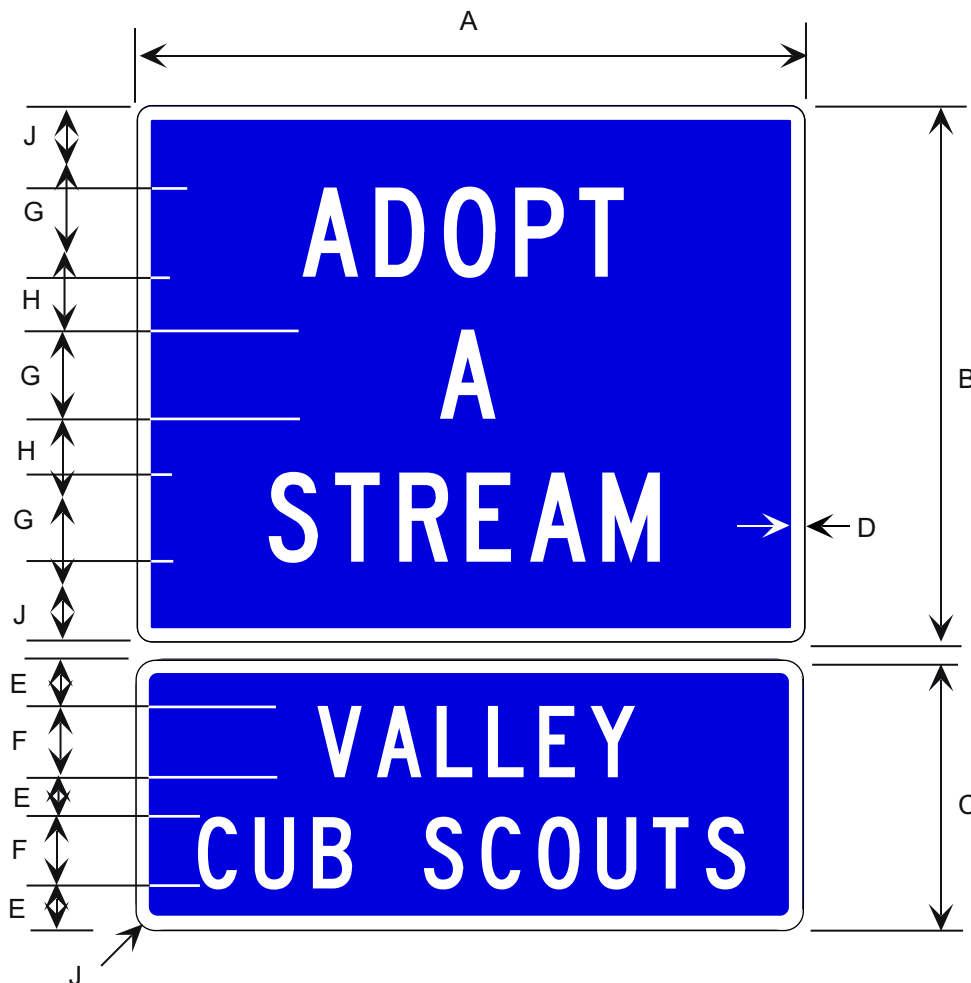

Border and Legend: White
 Background: Blue

Road Class	Dimensions (inches)								
	A	B	C	D	E	F	G	H	J
Min	24	18	12	0.75	2	3C	3C	3.0	1.5
Conv	30	24	12	0.75	2	3C	4C	3.5	2



Border and Legend: White
Background: Blue

Prior to the 2002 publication of this manual,
this sign was numbered AK-SP1-1.

Road Class	Dimensions (inches)							
	A	B	C	D	E	F	G	H
Conv & Min	30	36	1	3.5	5C	2	4E	1.88

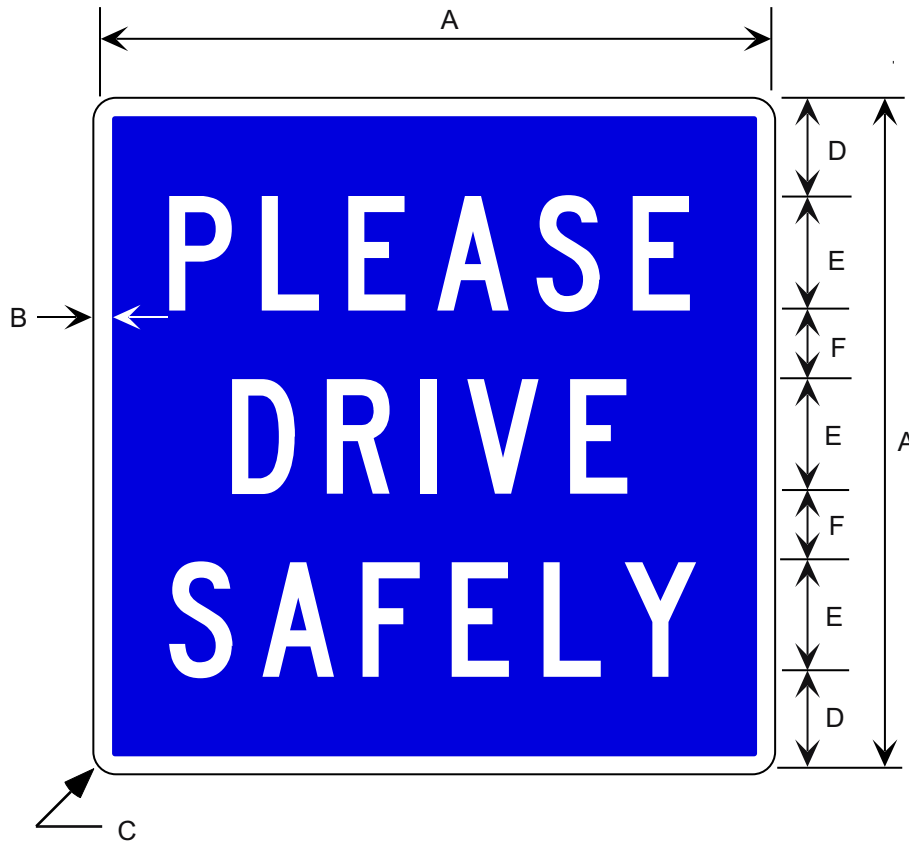

Border and Legend: White
Background: Blue

Prior to the 2002 publication of this manual,
this sign was numbered AK-SP1-2.

Road Class	Dimensions (inches)					
	A	B	C	D	E	F
Conv & Min	30	0.75	1.88	4.5	5C	3

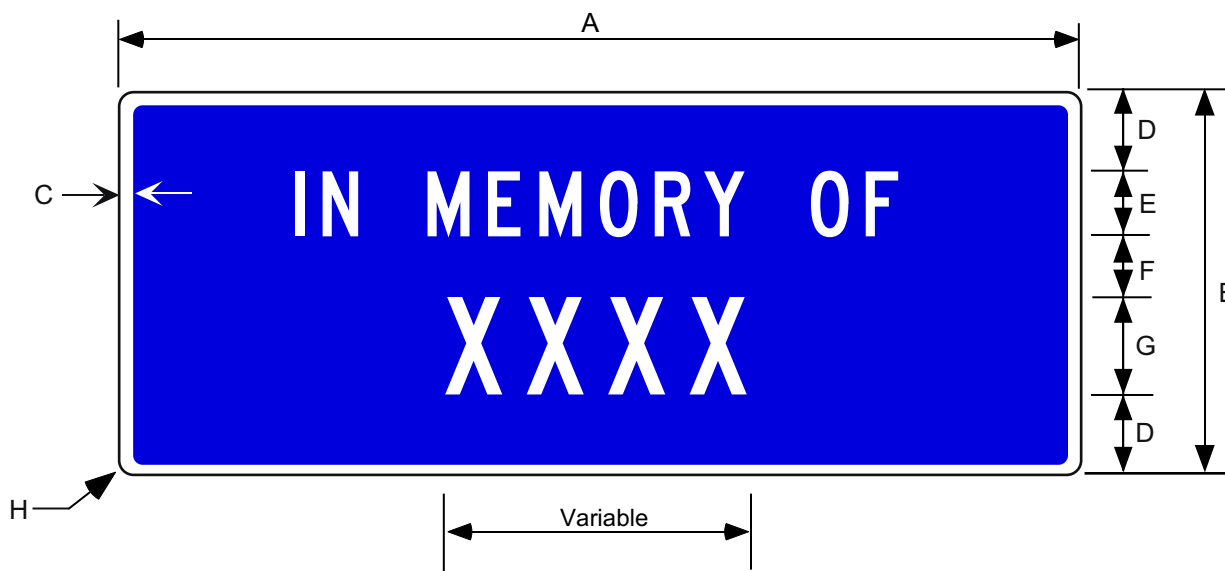

Border and Legend: White
Background: Blue

This plaque may be used in conjunction with a "PLEASE DON'T DRINK AND DRIVE" or a "PLEASE DRIVE SAFELY" sign.

Prior to the 2002 publication of this manual, this sign was numbered AK-SP1-3.

Road Class	Dimensions (inches)							
	A	B	C	D	E	F	G	H
Conv & Min	30	12	0.75	2.5	2C	2.0	3C*	1.5

* If the name is too long to fit, letter size may be reduced to 2" Series C. A 2.5" margin shall be maintained on either side of the name.

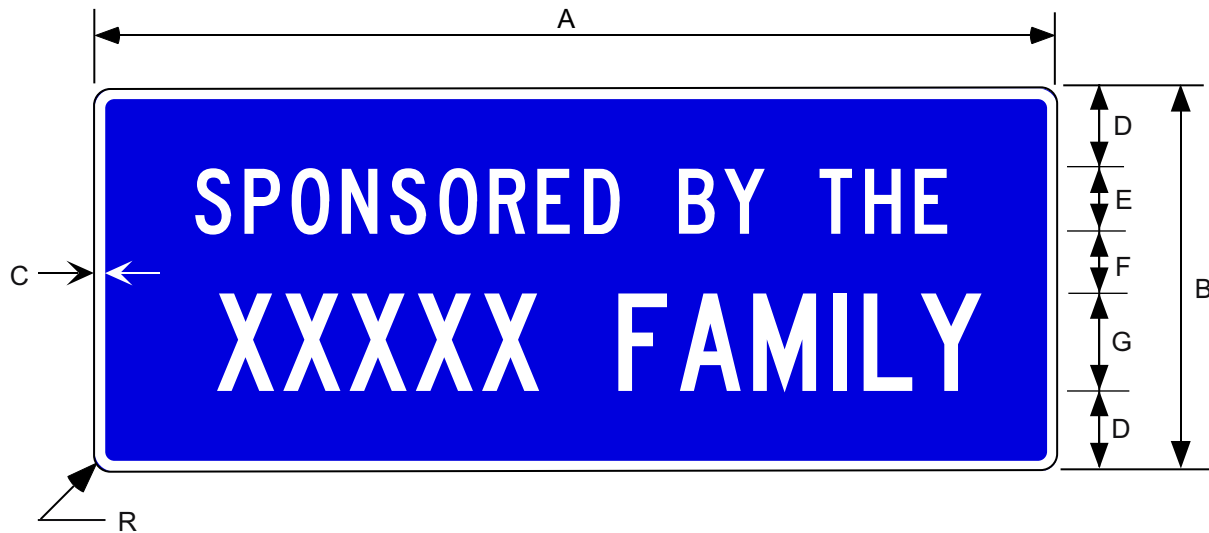

Border and Legend: White
Background: Blue

This plaque may be used in conjunction with
"PLEASE DON'T DRINK AND DRIVE" (I-160).

Prior to the 2002 publication of this manual,
this sign was numbered AK-SP1-4.

Road Class	Dimensions (inches)							
	A	B	C	D	E	F	G	R
Conv & Min	30	12	0.75	2.5	2C	2.0	3C*	1.5

* If the name is too long to fit, letter size may be reduced to 2" Series C. A 2.5" margin shall be maintained on either side of the name.

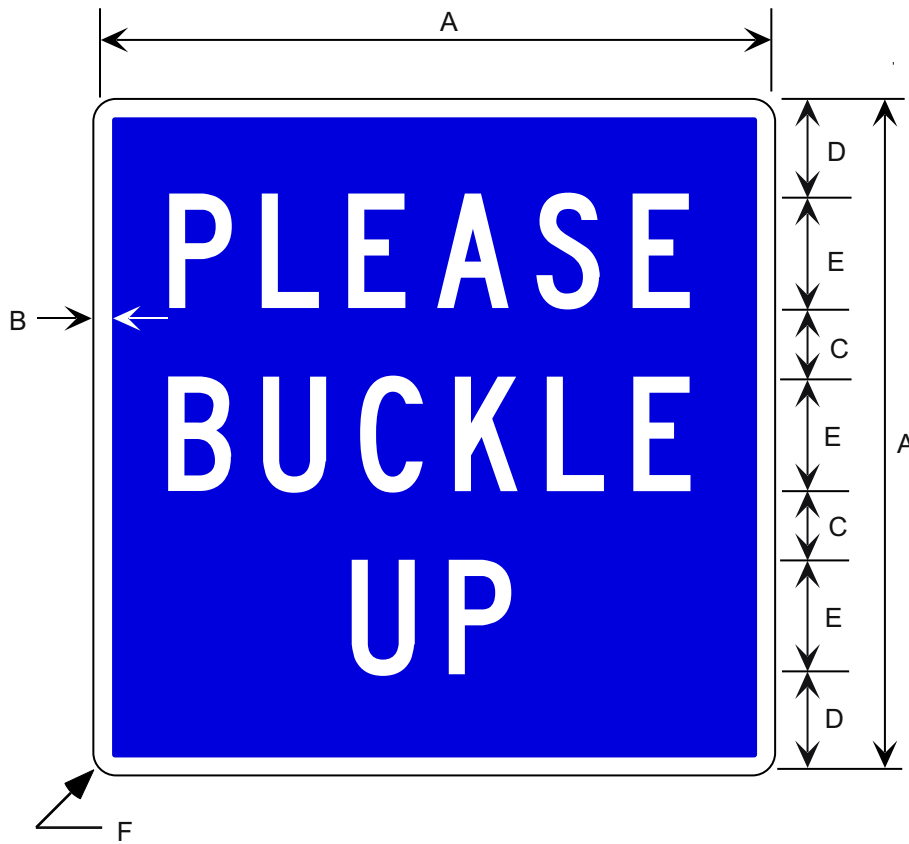

Border and Legend: White
 Background: Blue

Road Class	Dimensions (inches)					
	A	B	C	D	E	F
Conv & Min	30	0.75	3	4.5	5C	1.88



Sign graphics may be obtained in electronic form from the ADOT&PF State Traffic Engineer.

Use the following 3M Series 700 Colors or approved equivalents:
 708 Green (Two shades -100% and 50%)
 710 Blue
 722 Lemon Yellow (100% to 0% gradient)
 723 Magenta

Prior to the 2002 publication of this manual, this sign was numbered I-15B.

Make graphic and lettering proportional to those shown. Adjust as necessary to fit 24"x 30" sign size.

Road Class	Dimensions (inches)			
	A	B	C	D
Minimum	24	30	0.38	0.63
Standard	36	48	0.63	0.88

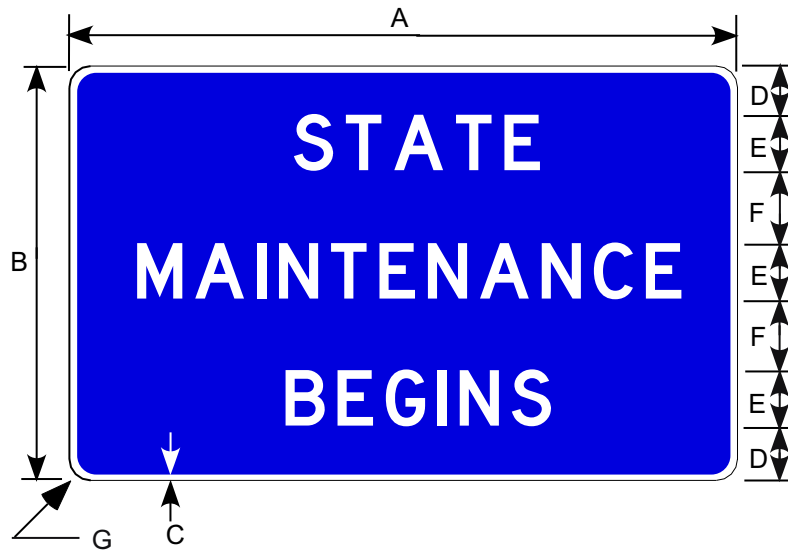

Border and Legend: White
Background: Blue

Prior to the 2002 publication of this manual,
this sign was numbered M8-1.

Road Class	Dimensions (inches)						
	A	B	C	D	E	F	G
Conv & min	30	18	0.5	2.5	3D	2	1.13

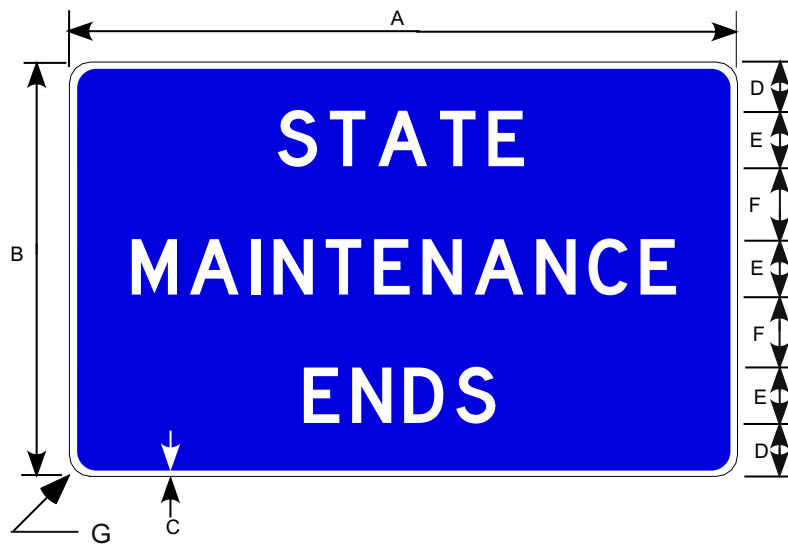

Border and Legend: White
Background: Blue

Prior to the 2002 publication of this manual,
this sign was numbered M8-2.

Road Class	Dimensions (inches)						
	A	B	C	D	E	F	G
Conv & Min	30	18	0.5	2.5	3D	2	1.13

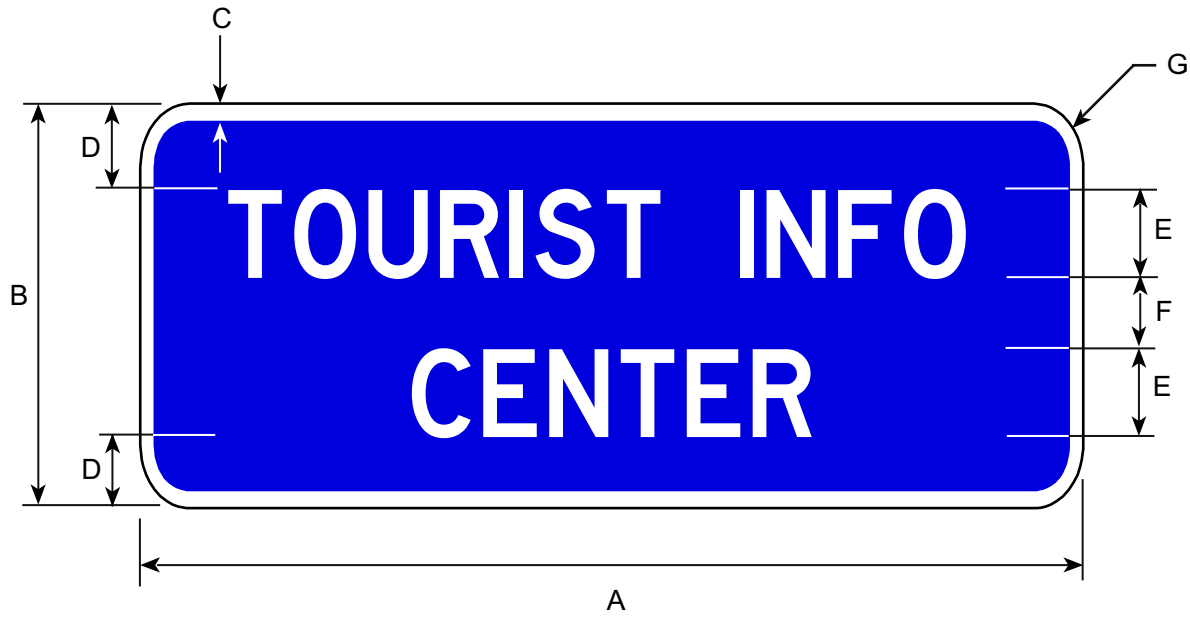

Border and Legend: White
 Background: Blue

Road	Dimensions (inches)						
Class	A	B	C	D	E	F	G
Conv & Min	72	30	0.75	6	6D	6	1.88
Expressway	90	36	1.00	6	8D	8	2.25
Freeway	120	54	1.25	10	12D	10	3.25



Border and Legend: White
 Background: Blue

Road	Dimensions (inches)						
Class	A	B	C	D	E	F	G
Conv & Min	72	30	0.75	6	6D	6	1.88
Expressway	90	36	1.00	6	8D	8	2.25
Freeway	120	54	1.25	10	12D	10	3.25

BUSINESS LOGO SIGNS

LG-F1x2 to LG-R1x3

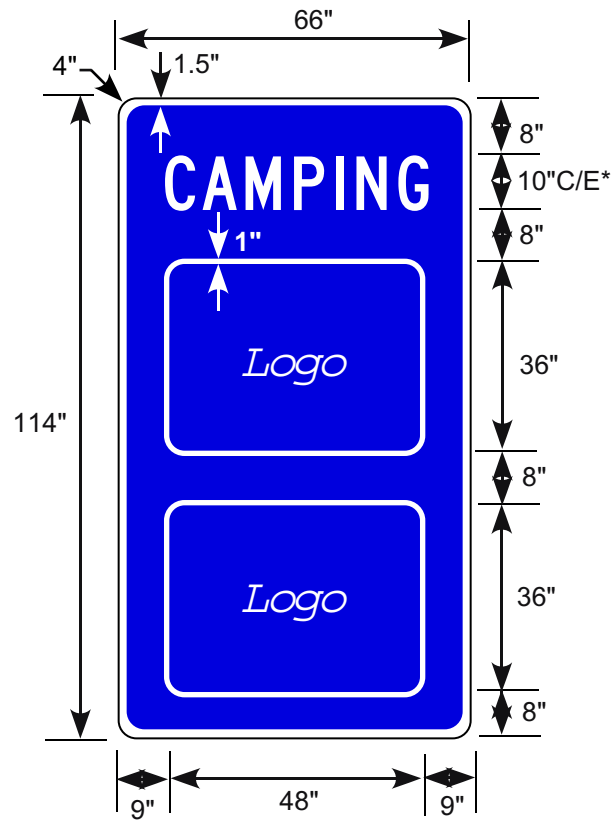

Border and Legend: White
Background: Blue

Alternative Headings:
CAMPING
FOOD
GAS
LODGING

* Use series E characters for "FOOD" and "GAS"
Use series C for "CAMPING" OR "LODGING".

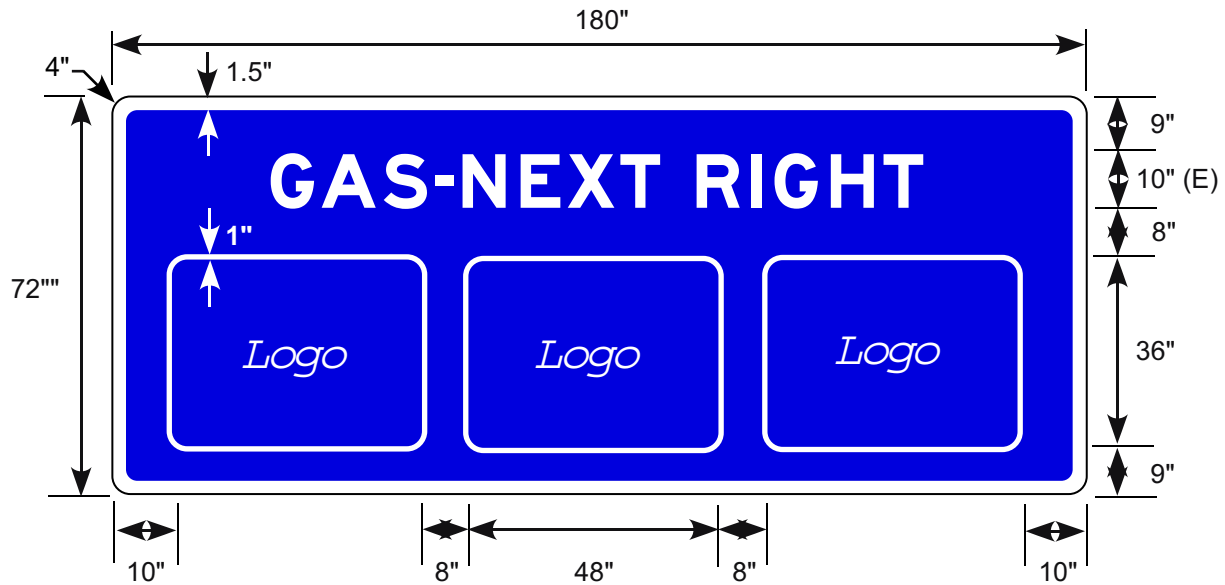

Border and Legend: White
Background: Blue

Alternative Service Types:
CAMPING
FOOD
GAS
LODGING

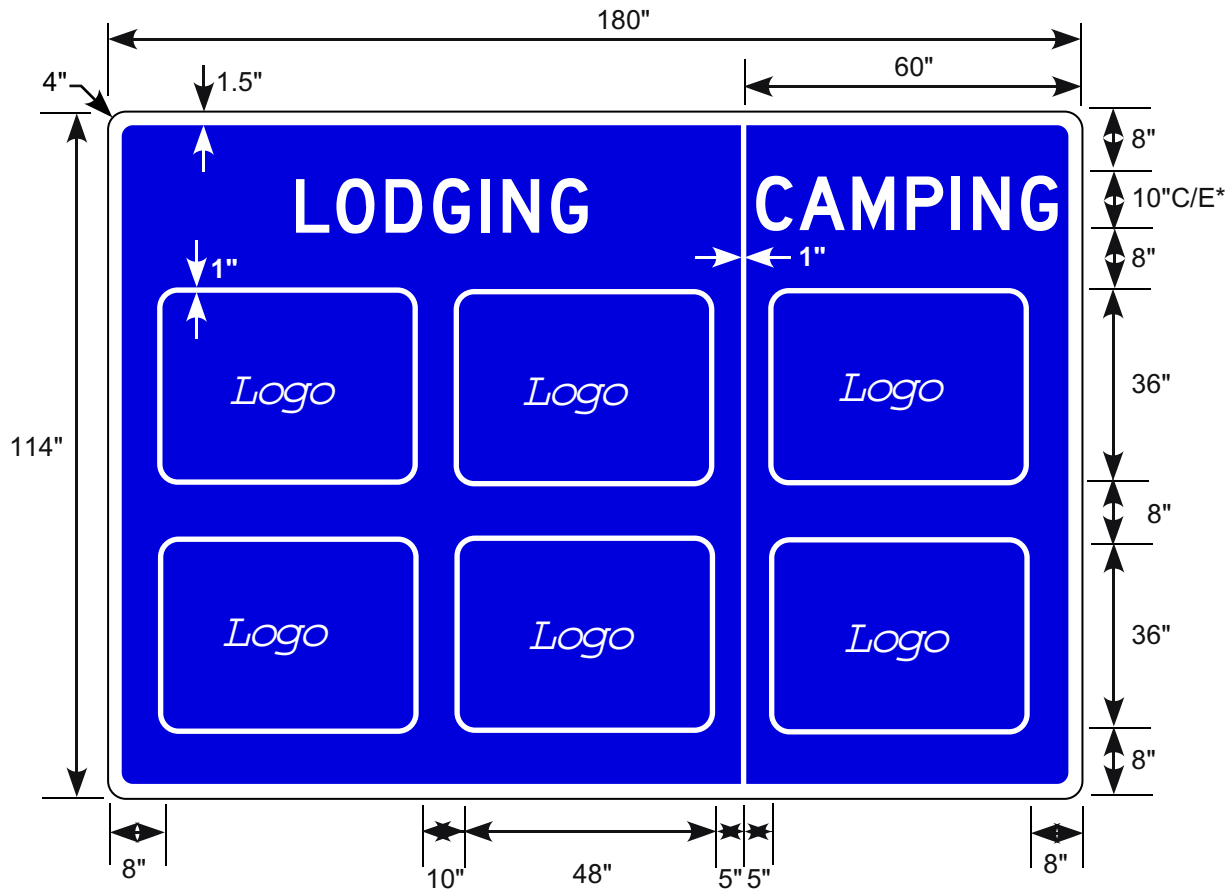

Border and Legend: White
Background: Blue

Alternative Headings:
CAMPING
FOOD
GAS
LODGING

* Use series E characters except for "CAMPING" OR "LODGING" when those words need to fit within a single column. In those cases, use series C.

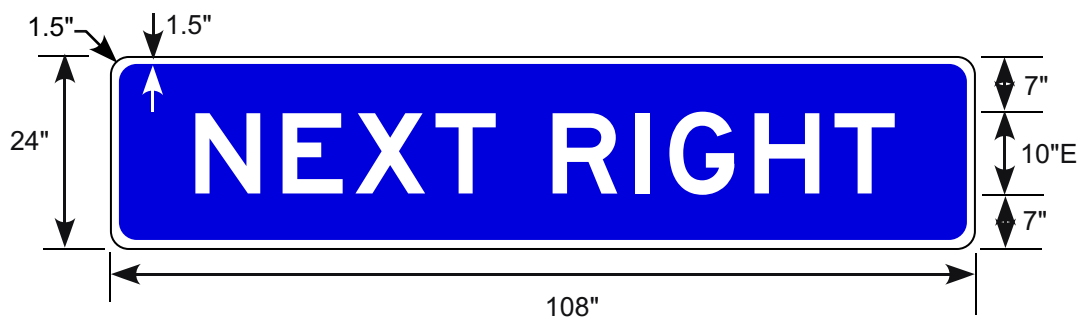

Border and Legend: White
Background: Blue

Intended to be used with 2 or 3 LG-F1x2 signs.

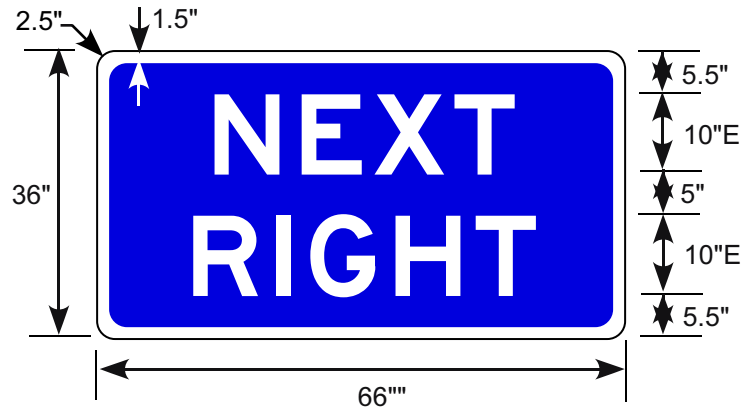

Border and Legend: White
Background: Blue

Intended to be used with one LG-F1x2 sign.

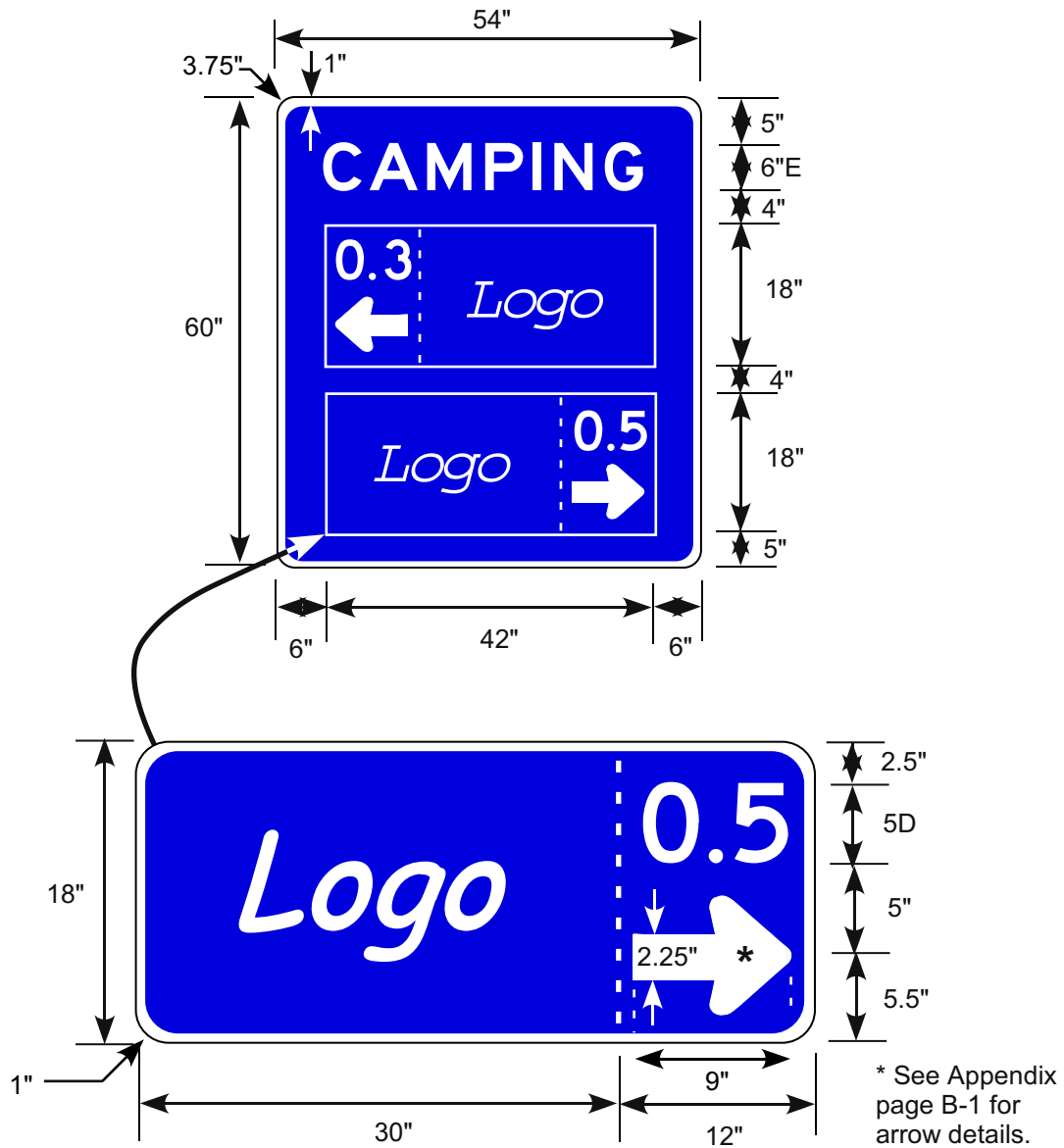

Border and Legend: White
 Background: Blue

Alternative Headings:
 CAMPING
 FOOD
 GAS
 LODGING

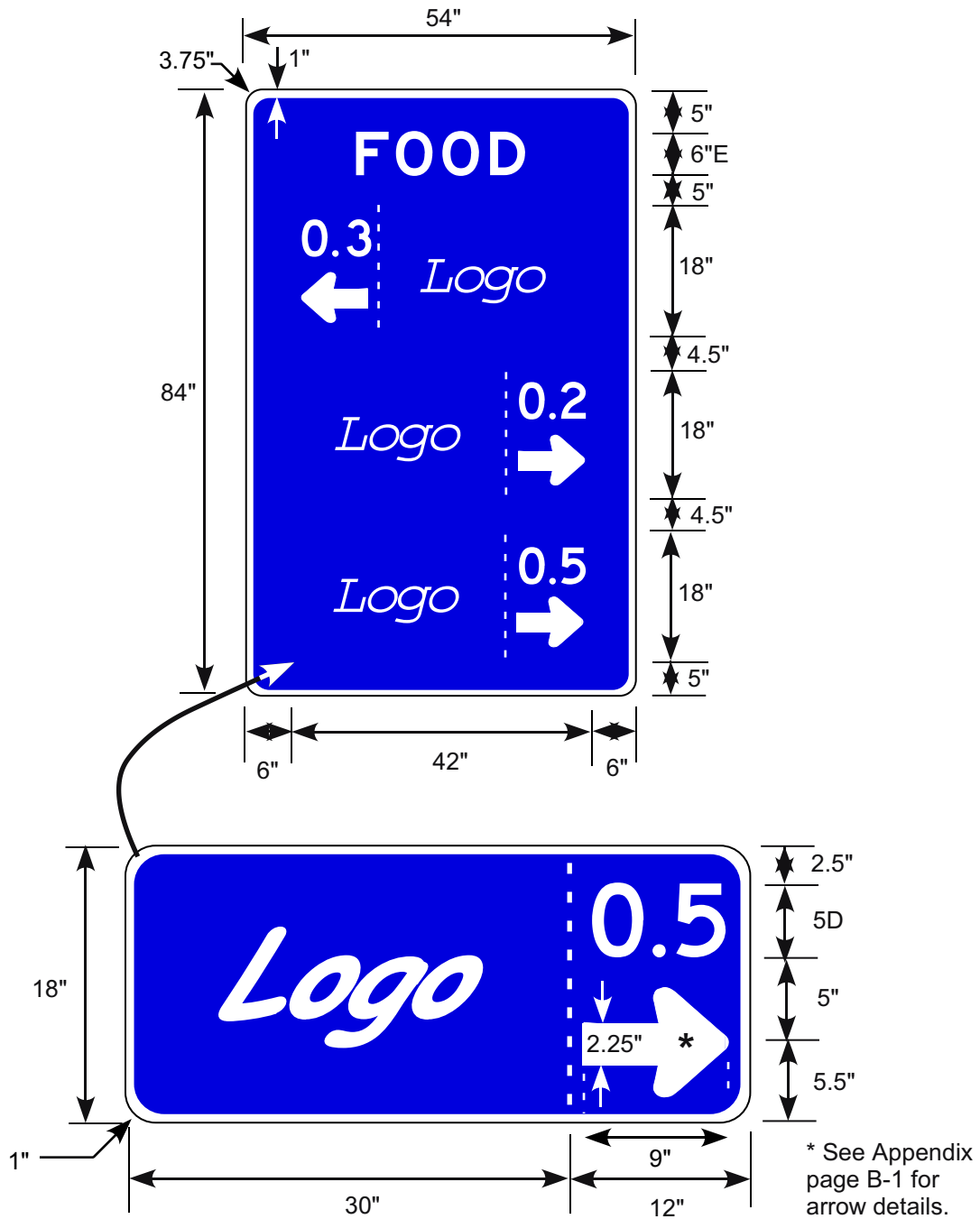

Border and Legend: White
Background: Blue

Alternative Headings:
CAMPING
FOOD
GAS
LODGING

MARKERS

M1-2 to M12-1

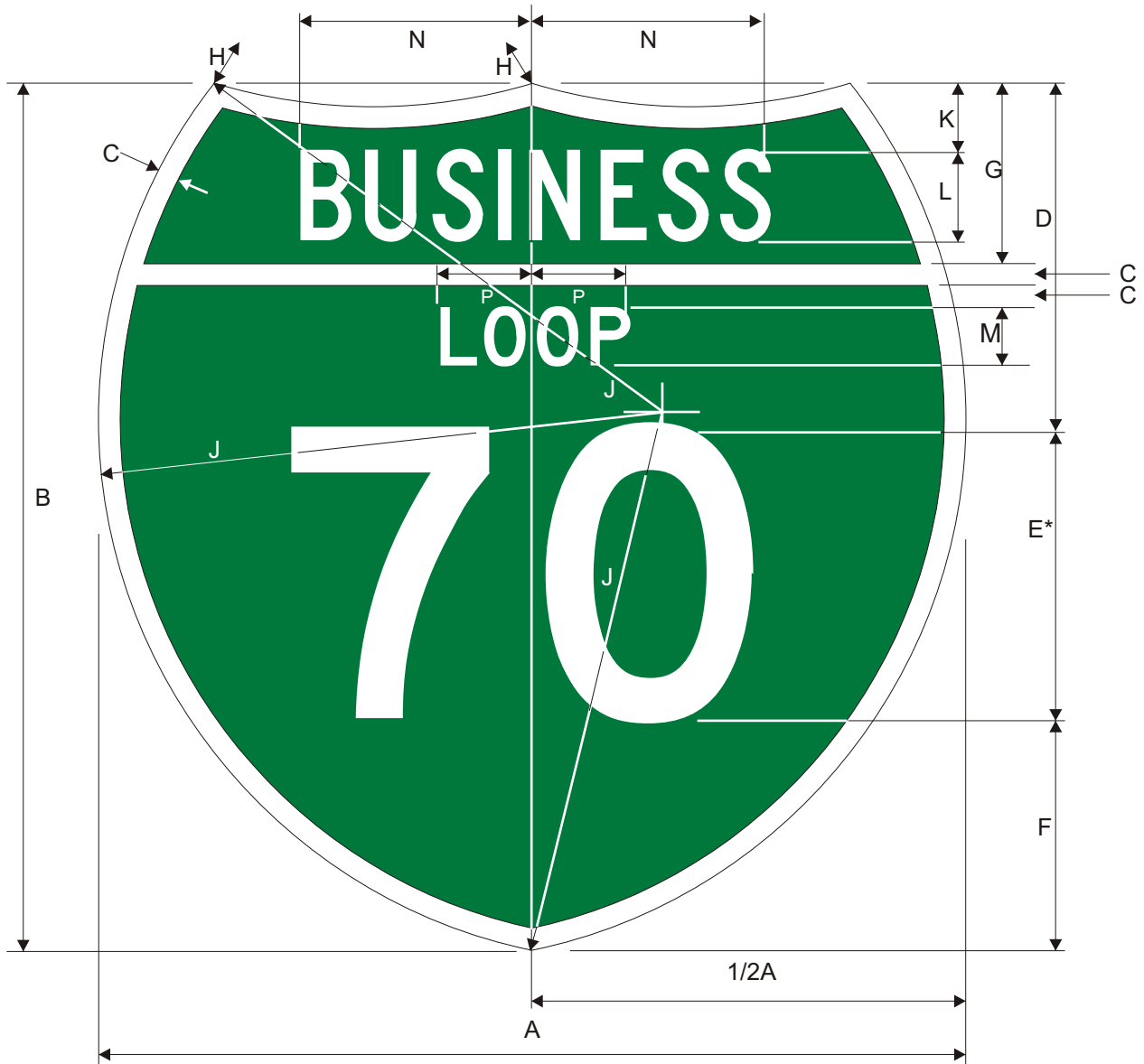

*Optically space numerals about vertical centerline.

Border and Legend: White
Background: Green

Road Class	Dimensions (inches)													
	A	B	C	D	E	F	G	H	J	K	L	M	N	P
1,2 digits	24	24	0.50	8.0	10D	6.0	5.0	15	15	2.0	2.5C	1.5D	6.63	2.5
1,2 digits	36	36	0.75	12	15D	9.0	7.5	22.5	22.5	3.0	3.75C	2.25D	9.94	3.75
1,2 digits	48	48	1.0	16	20D	12	10	30	30	4.0	5C	3D	13.25	5.0
3 digits	30	24	5.0	8.0	10D	6.0	5.0	24	17	2.0	2.5C	1.5D	6.63	2.5
3 digits	45	36	0.75	12	15D	9.0	7.5	36	25.5	3.0	3.75C	2.25D	9.94	3.8
3 digits	60	48	1.0	16	20D	12	10	48	34	4.0	5C	3D	13.25	5.0

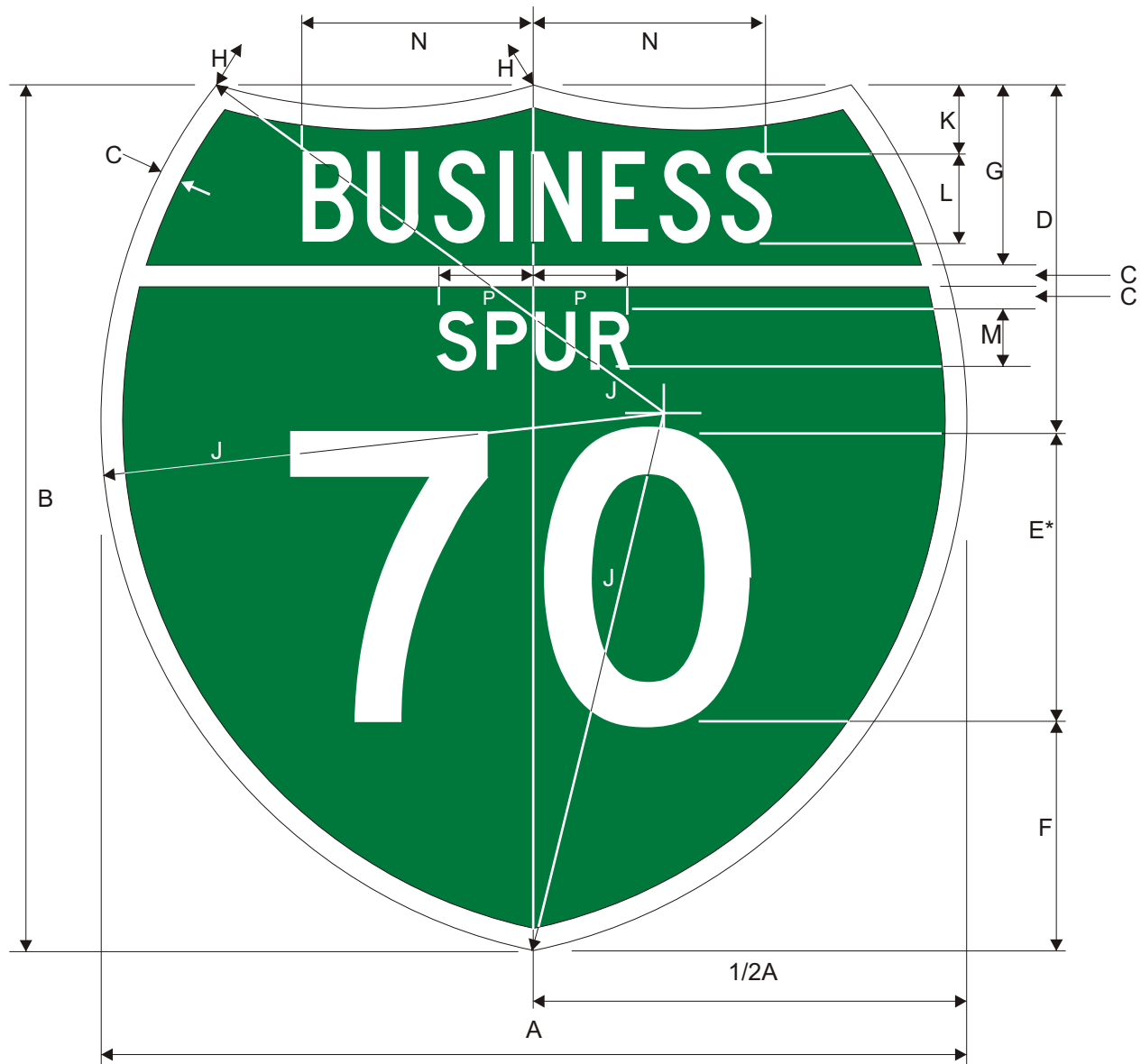

*Optically space numerals about vertical centerline.

Border and Legend: White
Background: Green

Road Class	Dimensions (inches)													
	A	B	C	D	E	F	G	H	J	K	L	M	N	P
1,2 digits	24	24	0.50	8	10D	6	5.0	15.0	15.0	2.0	2.5C	1.5D	6.63	2.56
1,2 digits	36	36	0.75	12	15D	9	7.5	22.5	22.5	3.0	3.75C	2.25D	9.94	3.84
1,2 digits	48	48	1	16	20D	12	10	30	30	4.0	5C	3D	13.25	5.13
3 digits	30	24	5	8	10D	6	5.0	24.0	17.0	2.0	2.5C	1.5D	6.63	2.56
3 digits	45	36	0.75	12	15D	9	7.5	36.0	25.5	3.0	3.75C	2.25D	9.94	3.84
3 digits	60	48	1	16	20D	12	10.0	48.0	34.0	4.0	5C	3D	13.25	5.13

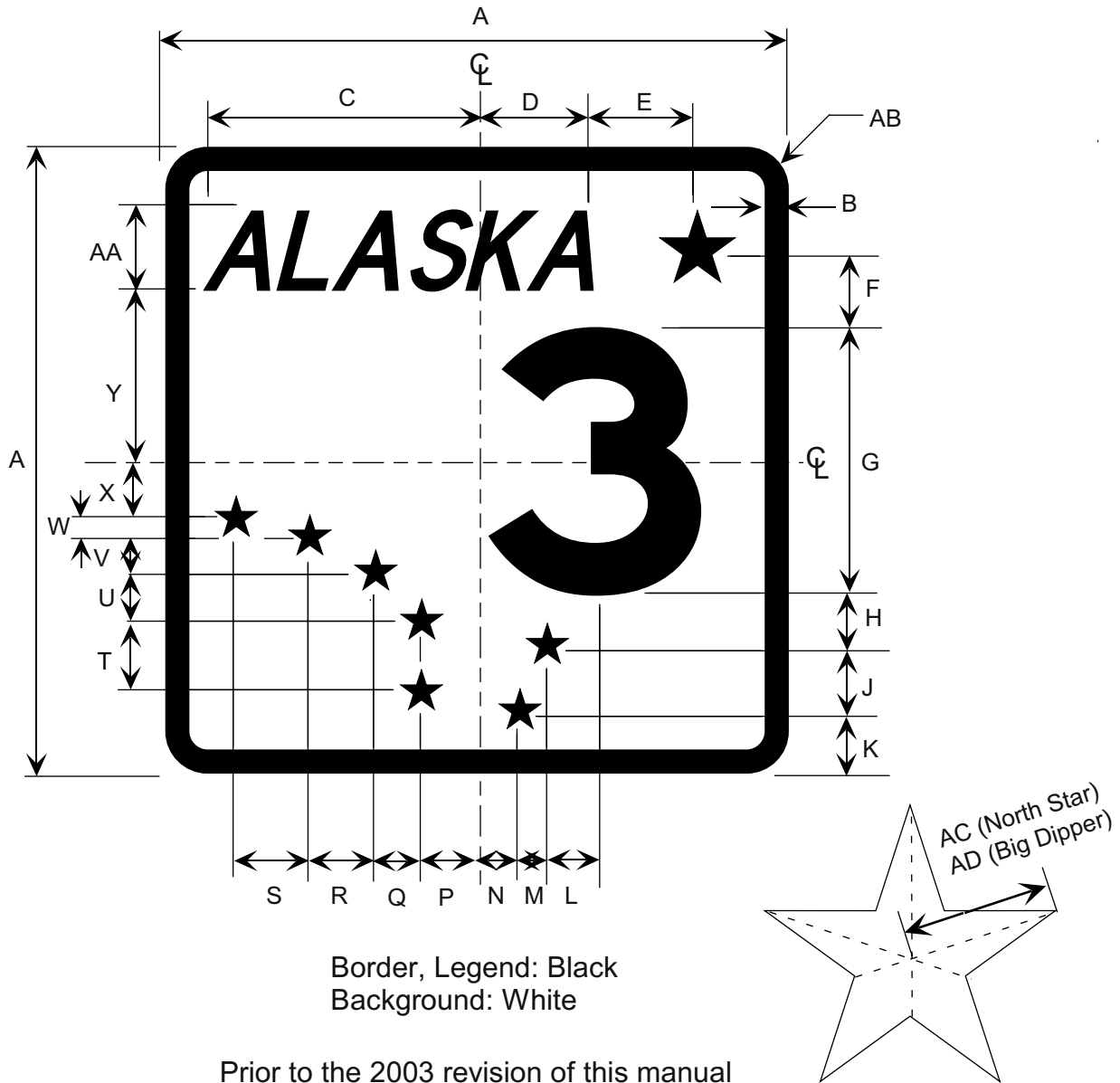

Border, Legend: Black
Background: White

Prior to the 2003 revision of this manual
this sign was numbered M1-6.

Note: When used as an inset in a larger sign, this plate may be reduced to 18"x18" when design considerations necessitate minimizing sign size.

Road Class	Dimensions (inches)													
	A	B	C	D	E	F	G	H	J	K	L	M	N	P
Minimum	24	0.75	10.13	4.13	4.31	3	10E	1.5	2.50	3.0	1.50	1.0	1.88	1.88
Conventional	36	1.00	16.00	6.25	6.50	4	16E	1.75	3.75	4.5	2.25	1.5	2.81	2.81
	Q	R	S	T	U	V	W	X	Y	AA	AB	AC	AD	
	1.75	2.56	2.88	2.69	1.63	1.31	0.69	2.13	6.50	3.0	1.5	1.50	0.94	
	2.63	3.88	4.31	4.00	2.44	1.94	1.06	3.06	9.75	4.5	1.5	2.25	1.38	



*Optically space numerals about vertical centerline.

Border and Legend: White
Background: Brown

Road Class	Dimensions (inches)								
	A	B	C	D	E	F	G	H	J
Minimum	12.75	18	0.5	2.63	6D	1.13	4	1.61	2.0
Conventional	17.00	24	0.5	3.50	8D	1.75	5	2.25	2.5

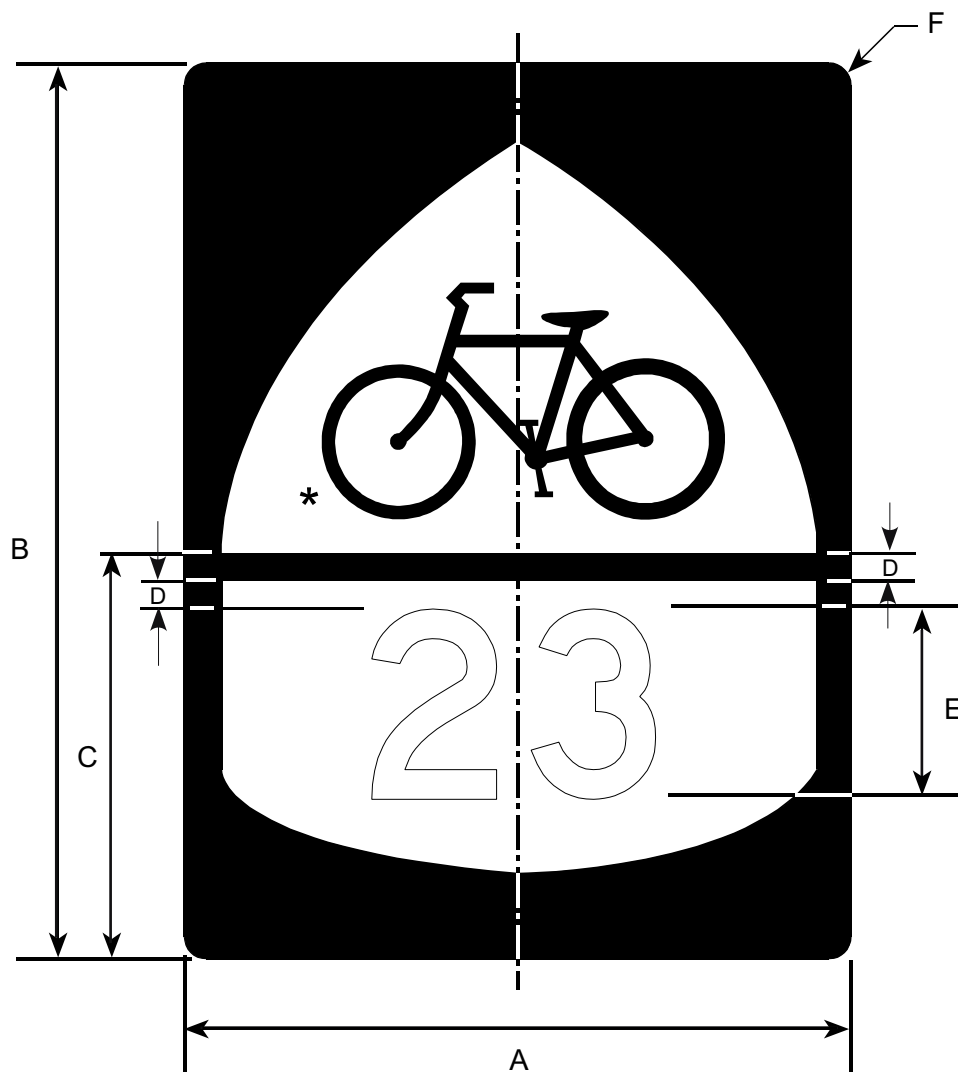

*Make symbol proportional to the graphic shown.

Legend: Black
 Inner Background: White
 Outer Background: Black

Route number is variable.

Road Class	Dimensions (inches)					
	A	B	C	D	E	F
Min & Conv	18	24	10.75	0.5	5D	1.5

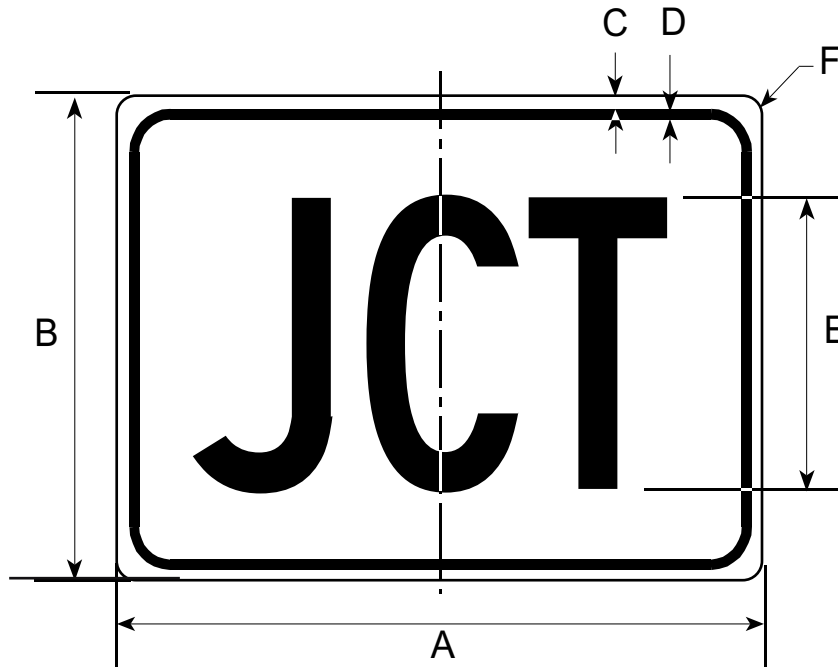

Border and Legend: Black
 Background: White

Road Class	Dimensions (inches)					
	A	B	C	D	E	F
Minimum	21	15	0.38	0.63	9C	1.5

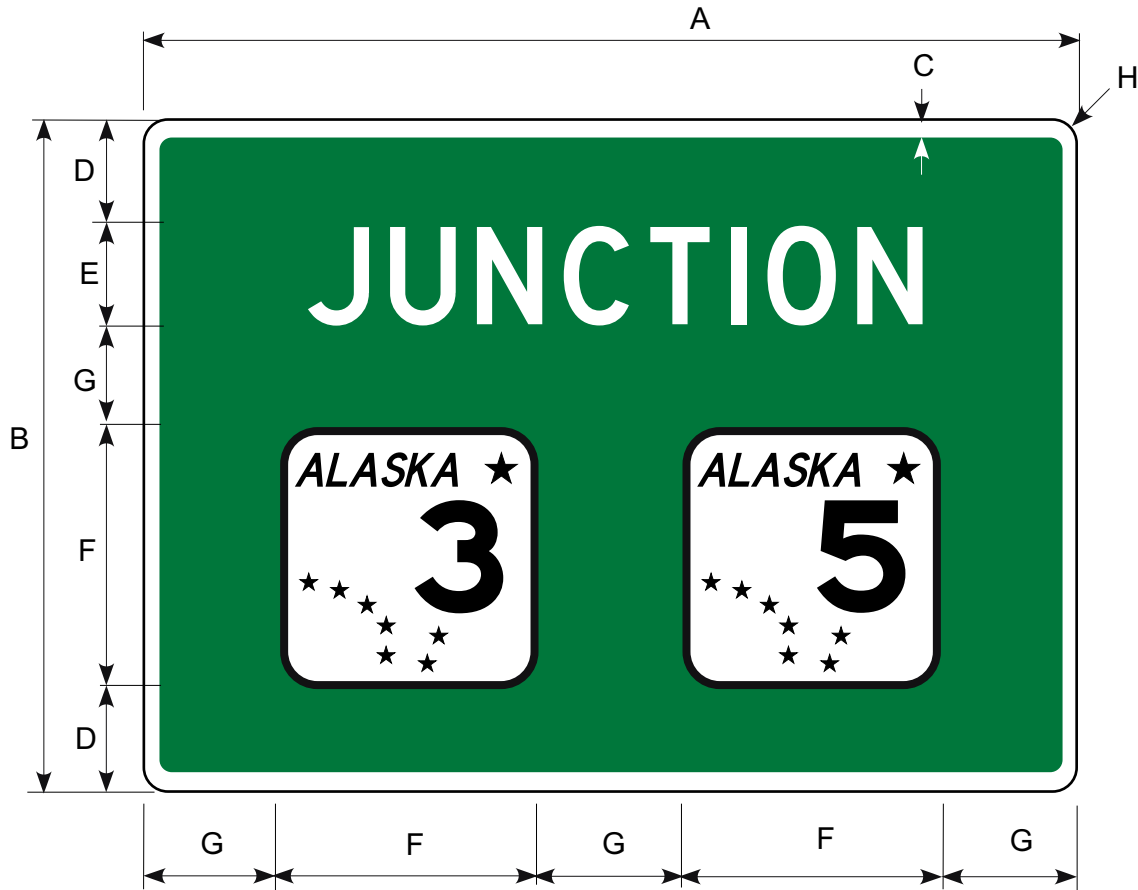

Legend: White
 Background: Green
 Route Plaque: Black on White

Make symbol proportional to
 the graphic shown.

Road Class	Dimensions (inches)							
	A	B	C	D	E	F	G	H
Expwy/Fwy	72	60	1.5	9.0	10C	24	8.0	3.75

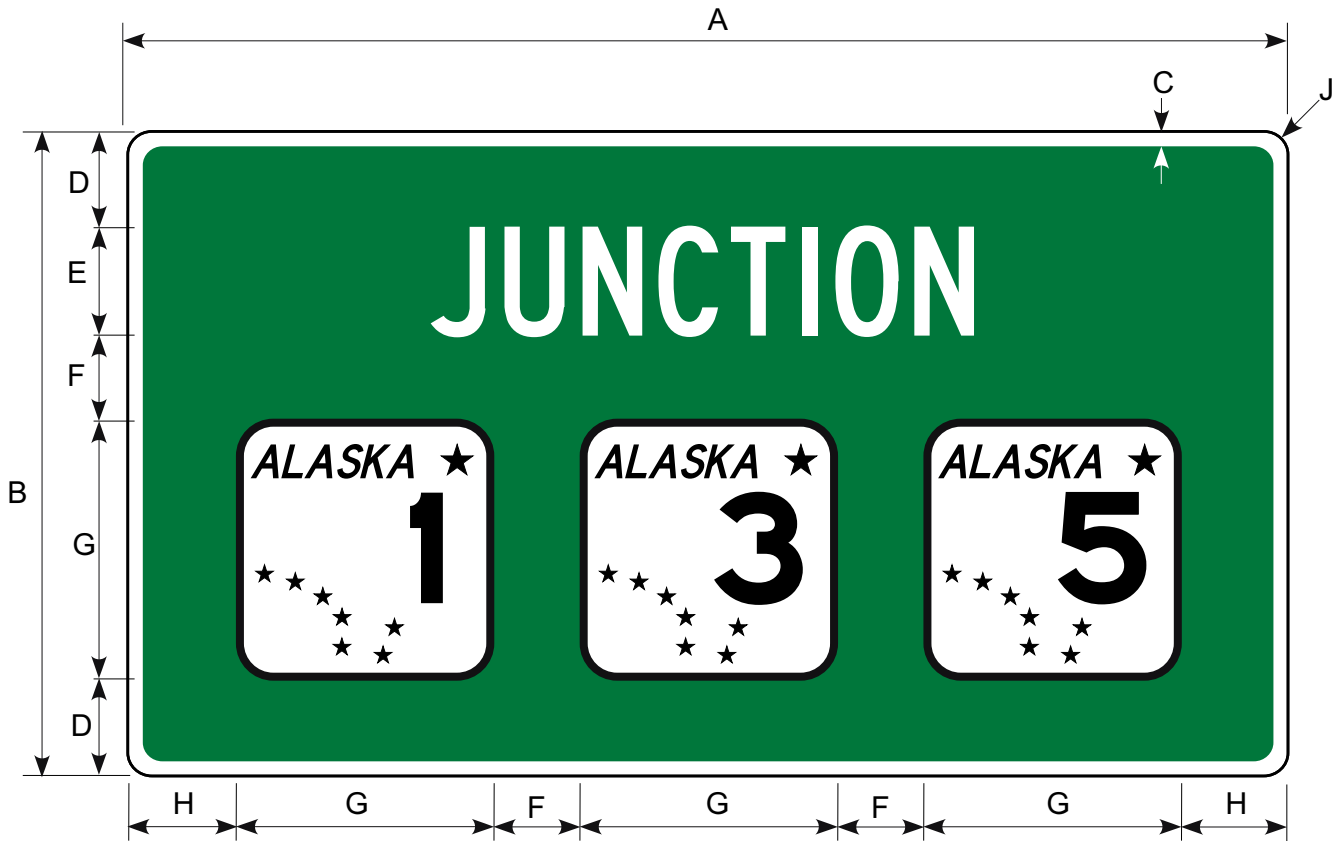

Legend: White
 Background: Green
 Route Plaque: Black on White

Make symbol proportional
 to graphic shown.

Road Class	Dimensions (inches)								
	A	B	C	D	E	F	G	H	J
Expwy/Fwy	108	60	1.50	9	10C	8	24	10	3.75

M3-1

M3-2

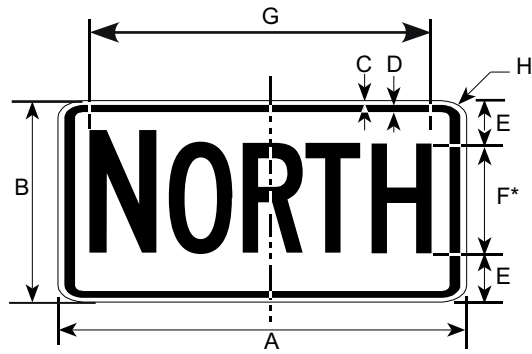

M3-1

* Make first letter 10% larger.

Road Class	Dimensions (inches)							
	A	B	C	D	E	F	G	H
Minimum	24	12	0.38	0.63	3.0	6C	19.38	1.5
Conventional	30	15	0.50	0.75	3.5	8C	24.80	1.88

Border and Legend: Black
Background: White

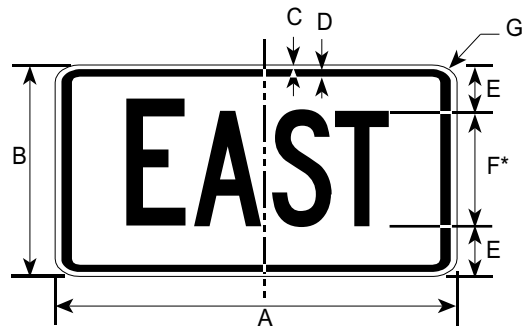

M3-2

* Make first letter 10% larger.

Road Class	Dimensions (inches)						
	A	B	C	D	E	F	G
Minimum	24	12	0.38	0.63	3.0	6C	1.5
Conventional	30	15	0.50	0.75	3.5	8C	1.88

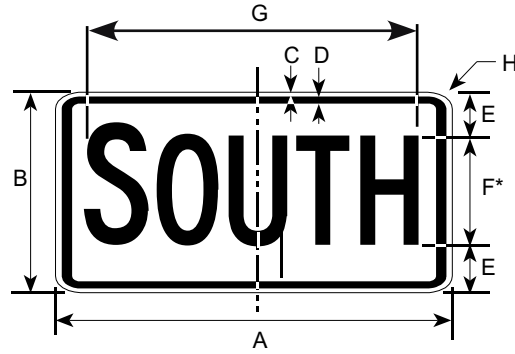

M3-3

*Make first letter 10% larger.

Road Class	Dimensions (inches)							
	A	B	C	D	E	F	G	H
Minimum	24	12	0.38	0.63	3.0	6C	19.19	1.5
Conventional	30	15	0.50	0.75	3.5	8C	24.59	1.88

Border and Legend: Black
Background: White

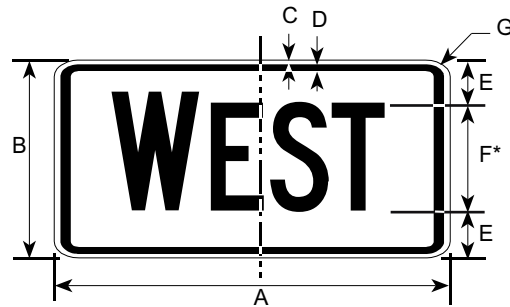

M3-4

*Make first letter 10% larger.

Road Class	Dimensions (inches)						
	A	B	C	D	E	F	G
Minimum	24	12	0.38	0.63	3.0	6C	1.5
Conventional	30	15	0.50	0.75	3.5	8C	1.88

M4-1
M4-1A
M4-2
M4-3

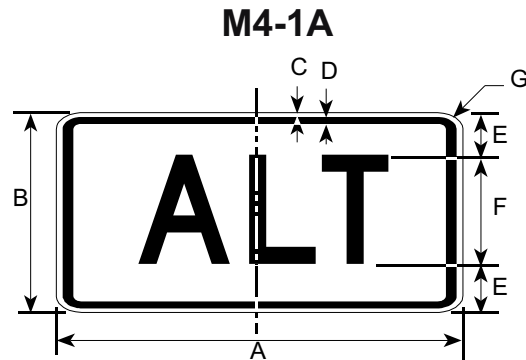
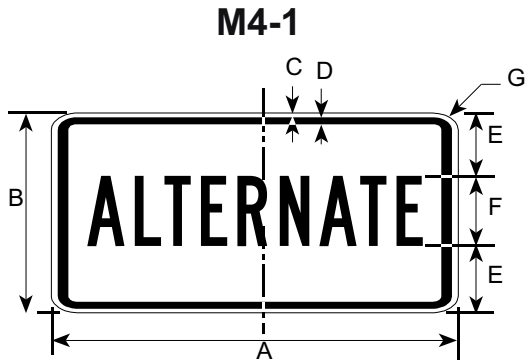

Road Class	Dimensions (inches)						
	A	B	C	D	E	F	G
Minimum	24	12	0.38	0.63	4.0	4B	1.5
Conventional	30	15	0.38	0.63	4.5	6B	1.5

Dimensions (inches)							
A	B	C	D	E	F	G	
24	12	0.38	0.63	3.0	6C	1.5	
30	15	0.38	0.63	3.5	8C	1.5	

Border and Legend: Black
 Background: White

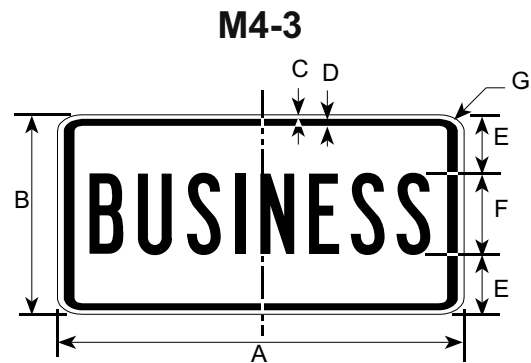
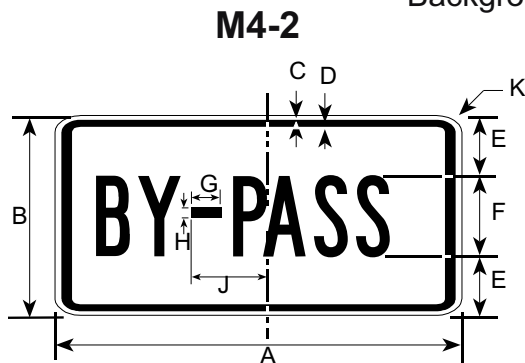

Road Class	Dimensions (inches)										
	A	B	C	D	E	F	G	H	J	K	
Minimum	24	12	0.38	0.63	3.5	5B	0.75	0.63	3.38	1.5	
Conventional	30	15	0.38	0.63	4.0	7B	1.0	0.88	3.88	1.5	

Dimensions (inches)							
A	B	C	D	E	F	G	
24	12	0.38	0.63	3.5	5B	1.5	
30	15	0.38	0.63	4.0	7B	1.5	

M4-4
M4-5
M4-6

M4-4

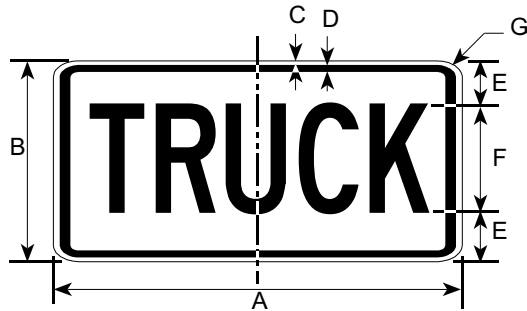

M4-6

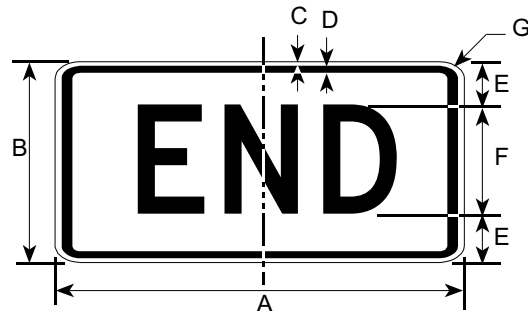

Road Class	Dimensions (inches)						
	A	B	C	D	E	F	G
Minimum	24	12	0.38	0.63	3.0	6C	1.5
Conventional	30	15	0.38	0.63	3.5	8C	1.5

Road Class	Dimensions (inches)						
	A	B	C	D	E	F	G
Minimum	24	12	0.38	0.63	3.0	6D	1.5
Conventional	30	15	0.38	0.63	3.5	8D	1.5

Border and Legend: Black
 Background: White

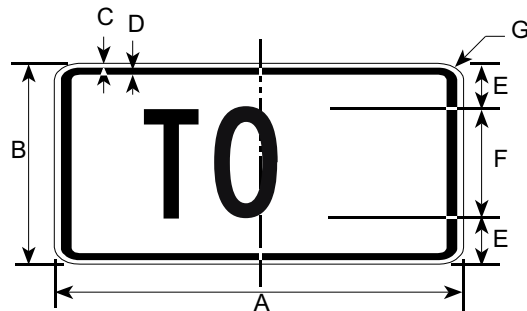

M4-5

Road Class	Dimensions (inches)						
	A	B	C	D	E	F	G
Minimum	24	12	0.38	0.63	3.0	6E	1.5
Conventional	30	15	0.38	0.63	3.5	8E	1.5

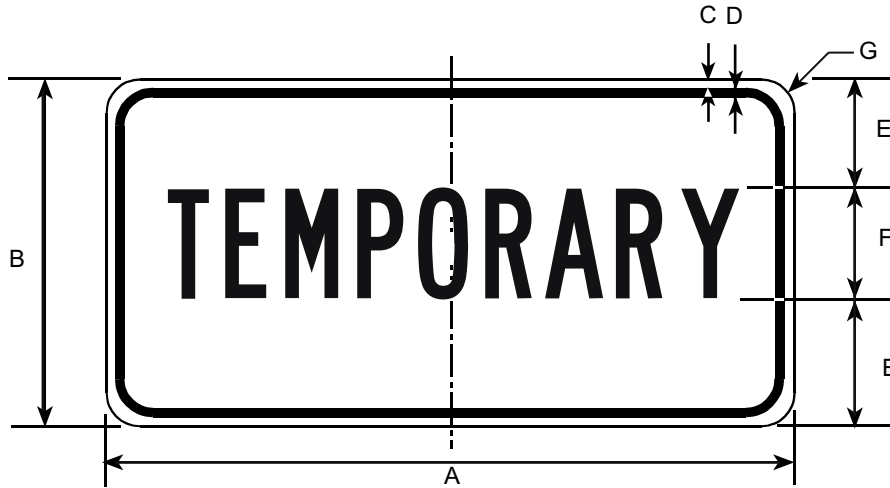

Border and Legend: Black
Background: White

Road Class	Dimensions (inches)						
	A	B	C	D	E	F	G
Minimum	24	12	0.38	0.63	4	4B	1.5
Conventional	30	15	0.38	0.63	5	5B	1.5

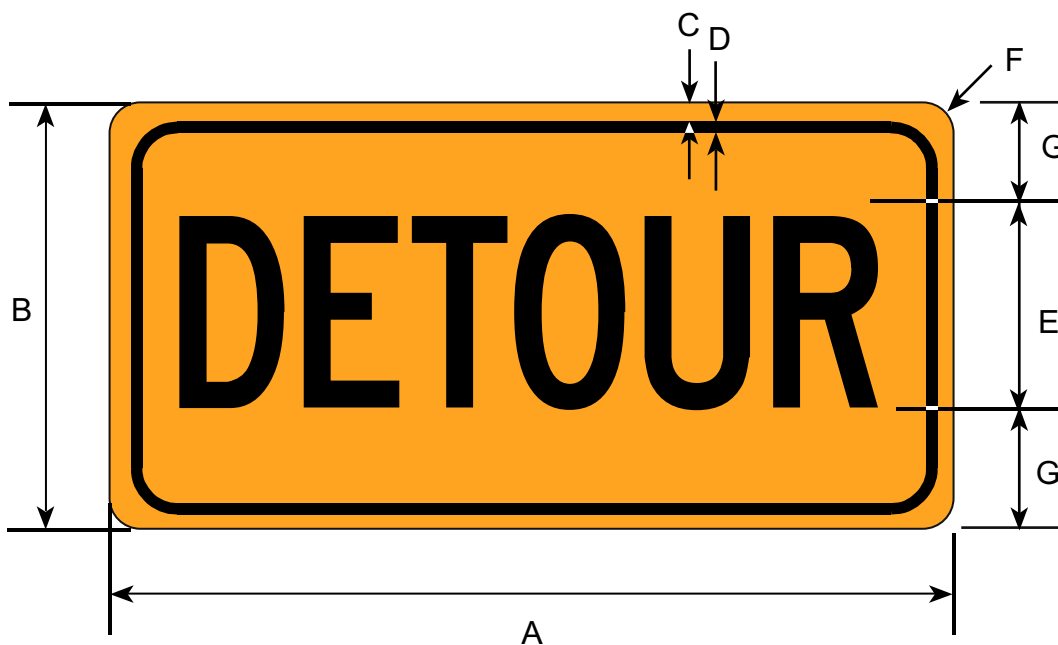

Border and Legend: Black
Background: Orange

Road Class	Dimensions (inches)						
	A	B	C	D	E	F	G
Conv & Min	24	12	0.38	0.63	6B	1.5	3.0
Expwy/Fwy	30	15	0.38	0.63	8B	1.5	3.5

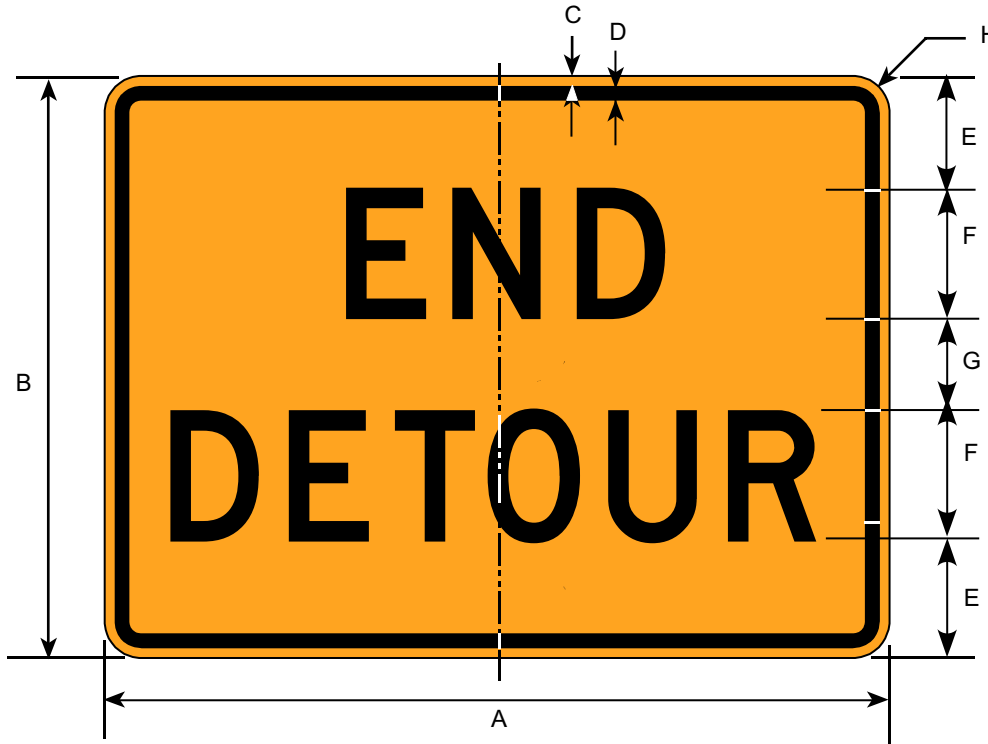

Border and Legend: Black
Background: Orange

Road Class	Dimensions (inches)							
	A	B	C	D	E	F	G	H
Conv & Min	24	18	0.38	0.63	3.5	4D	3	1.5
Expwy/Fwy	30	24	0.63	0.88	4.5	6D	3	1.5

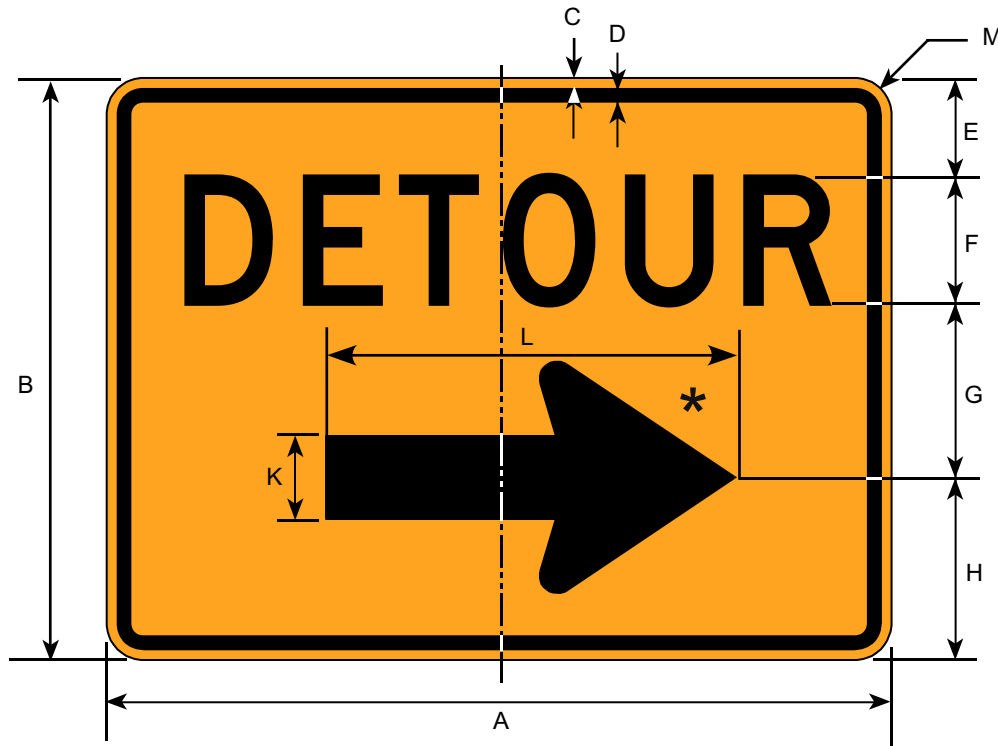

Border and Legend: Black
Background: Orange

* See Appendix B-1 for Standard Arrow Details.

Road Class	Dimensions (inches)										
	A	B	C	D	E	F	G	H	K	L	M
Minimum	30	24	0.38	0.63	4.0	5D	7.0	8.0	4.5	18	1.5
Conventional	48	36	0.63	0.88	6.0	8D	10	12	7.0	27	2.25
Expressway	60	48	0.75	1.25	8.0	10D	14	16	9.0	36	3.0

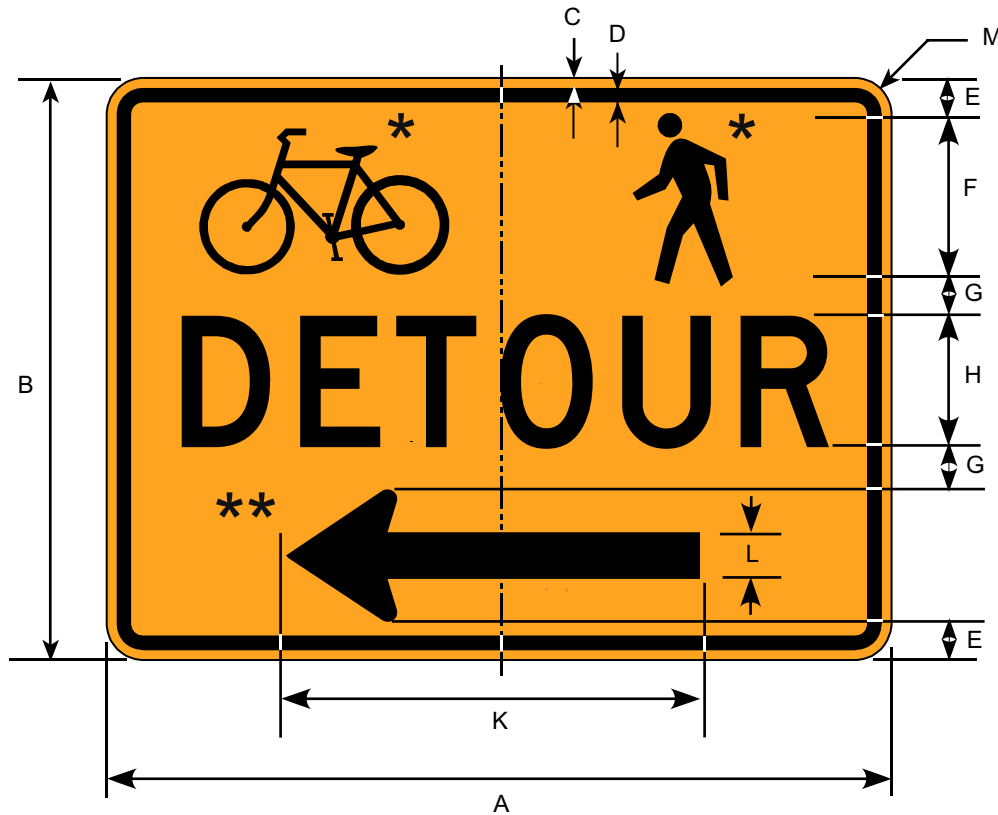

Border and Legend: Black
Background: Orange

*Make symbols proportional to the graphic shown.

** See Appendix B-1 for Standard Arrow Details.

Road Class	Dimensions (inches)										
	A	B	C	D	E	F	G	H	K	L	M
Bike (Ped)	30	24	0.38	0.63	2.0	5.0	2.5	5D	16	1.25	1.5

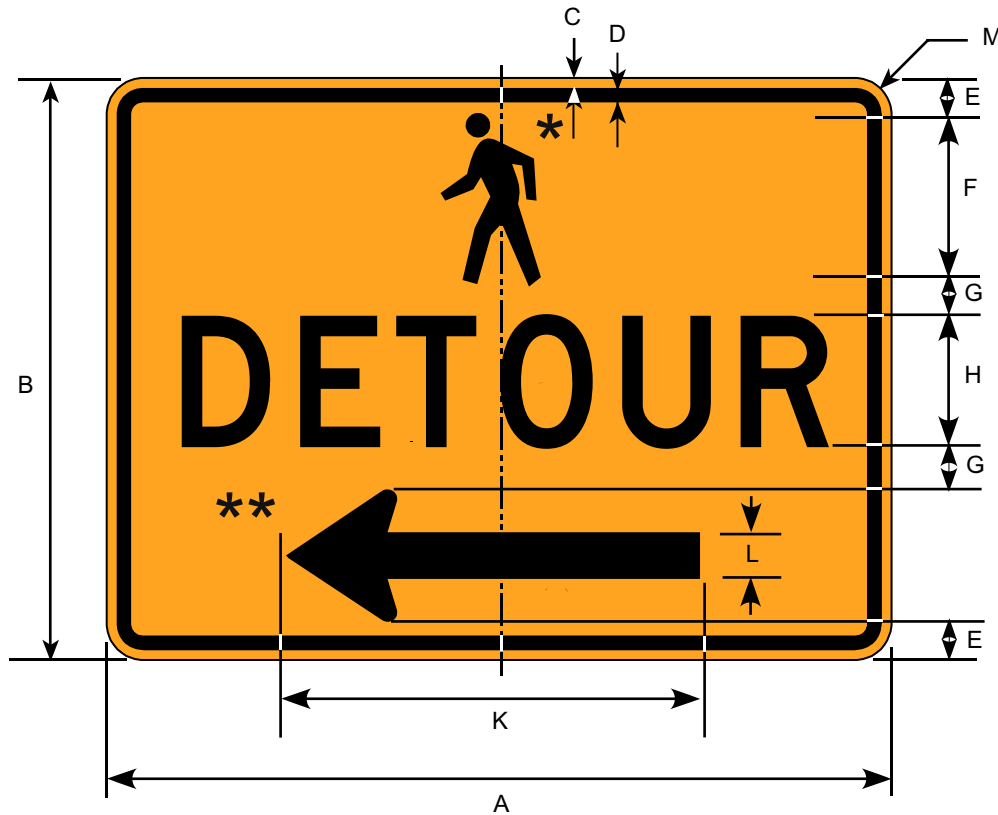

Border and Legend: Black
Background: Orange

*Make symbol proportional
to the graphic shown.

** See Appendix B-1 for Standard Arrow Details.

Road Class	Dimensions (inches)										
	A	B	C	D	E	F	G	H	K	L	M
Pedestrian Only	30	24	0.38	0.63	2.0	5.0	2.5	5D	16	1.25	1.5

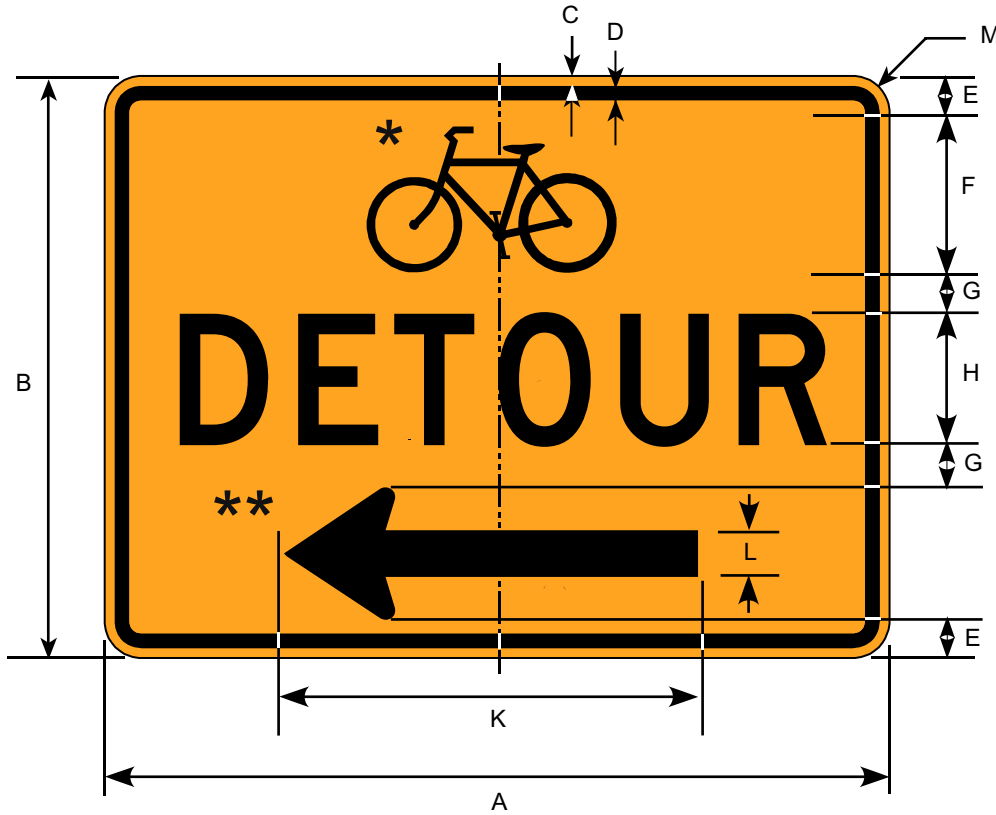

Border and Legend: Black
Background: Orange

*Make symbol proportional
to the graphic shown.

** See Appendix B-1 for Standard Arrow Details.

Road Class	Dimensions (inches)										
	A	B	C	D	E	F	G	H	K	L	M
Bike	30	24	0.38	0.63	2.0	5.0	2.5	5D	16	1.25	1.5

M4-10

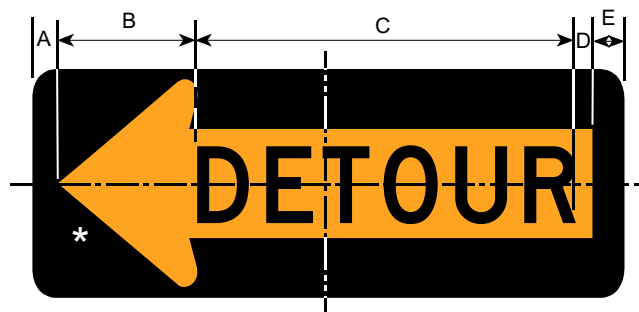

M4-10L

Road Class	Dimensions (inches)				
	A	B	C	D	E
Conv & Min	2.75	12.5	27.75	2.0	3.0

Legend and Background: Black
Arrow: Orange

* See Appendix B-1 for Standard Arrow Details.

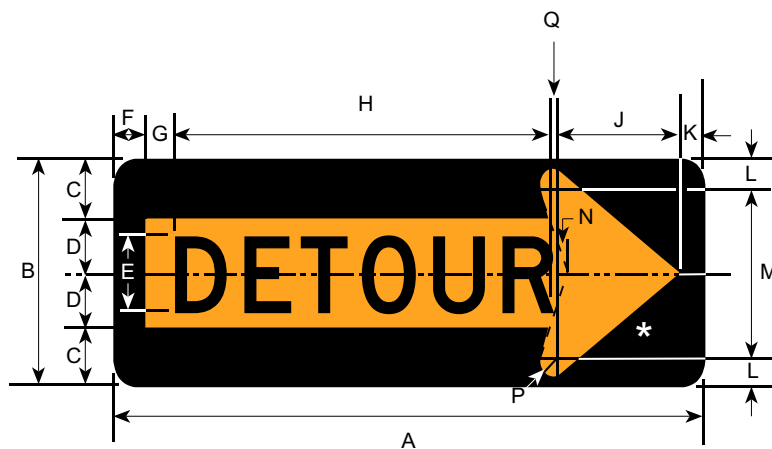

M4-10R

Road Class	Dimensions (inches)															
	A	B	C	D	E	F	G	H	J	K	L	M	N	P	Q	
Conv & Min	48	18	4.88	4.12	6D	3.0	2.0	27.75	12	2.75	2.25	13.5	0.75	1.25	0.50	

M4-100
M4-101
M4-102

M4-100



Road Class	Dimensions (inches)					
	A	B	C	D	E	F
Bike	12	4.0	0.25	1.0	2C	0.75
Conv & Min	24	6.0	0.50	1.0	4C	1.50

Border and Legend: White or Black
 Background: Green or White

M4-101

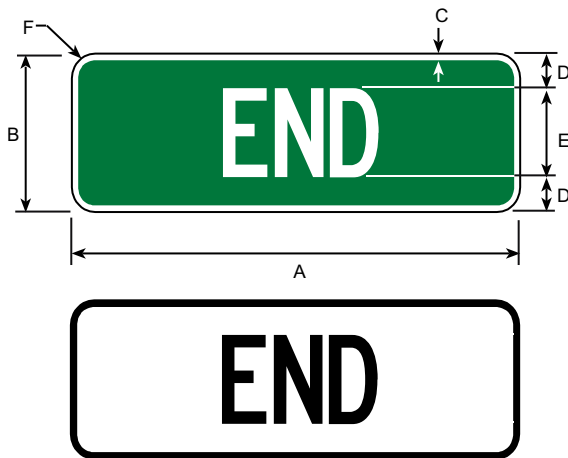

M4-102

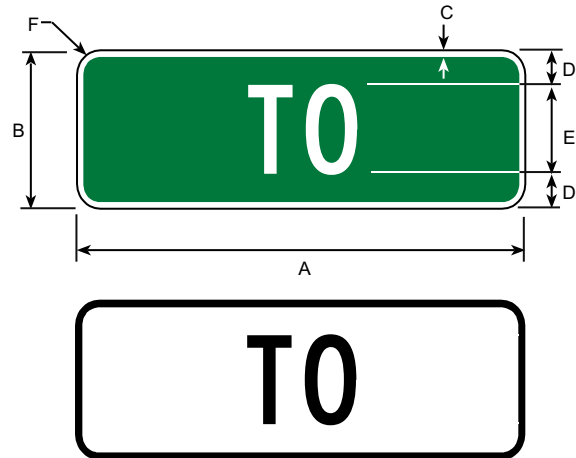

Road Class	Dimensions (inches)					
	A	B	C	D	E	F
Bike	12	4.0	0.25	1.0	2C	0.75
Conv & Min	24	6.0	0.50	1.0	4C	1.50

Road Class	Dimensions (inches)					
	A	B	C	D	E	F
Bike	12	4.0	0.25	1.0	2C	0.75
Conv & Min	24	6.0	0.50	1.0	4C	1.50

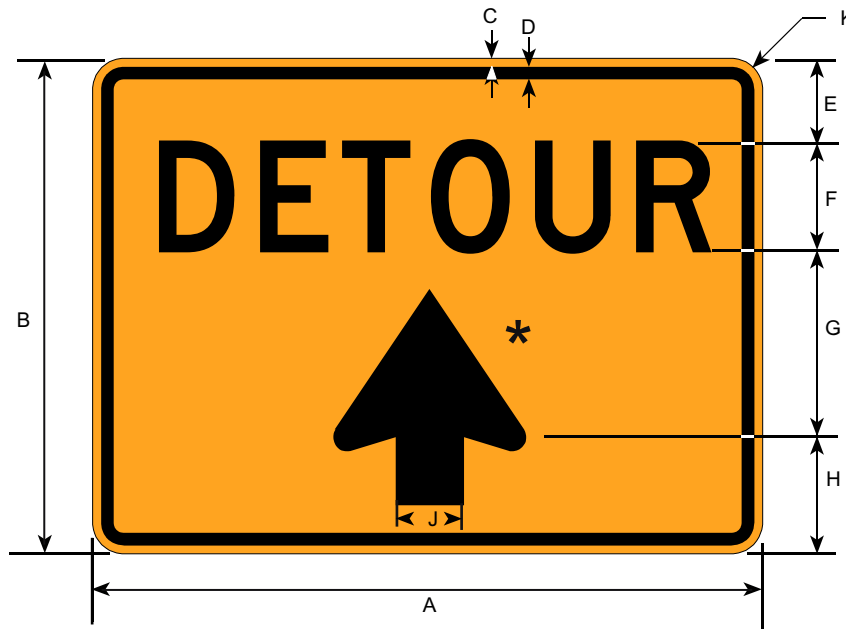

Border and Legend: Black
Background: Orange

* See Appendix B-1 for Standard Arrow Details.

Prior to the 2003 revision of this manual
this sign was numbered M4-9A.

Road Class	Dimensions (inches)									
	A	B	C	D	E	F	G	H	J	K
Minimum	30	24	0.38	0.63	4.0	5D	7.0	8.0	4.5	1.5
Conventional	48	36	0.63	0.88	6.0	8D	10	12	7.0	2.25
Expressway	60	48	0.75	1.25	8.0	10D	14	16	9.0	3.0

M5-1 M5-2

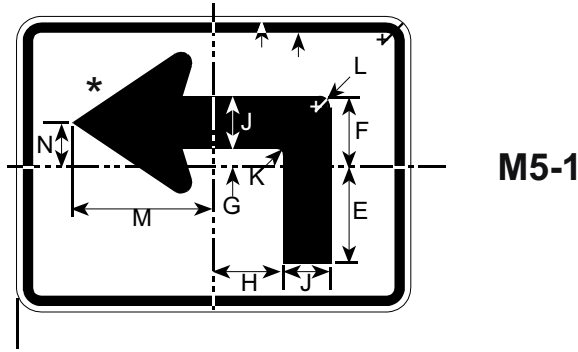

Road Class	Dimensions (inches)														
	A	B	C	D	E	F	G	H	J	K	L	M	N	P	
Minimum	21	15	0.38	0.63	5.06	3.38	0.75	3.19	2.63	0.38	0.56	7.13	2.06	1.5	

Border and Legend: Black
Background: White

Border and Legend: White
Background: Blue, Green, or Brown

* See Appendix B-1 for Standard Arrow Details.

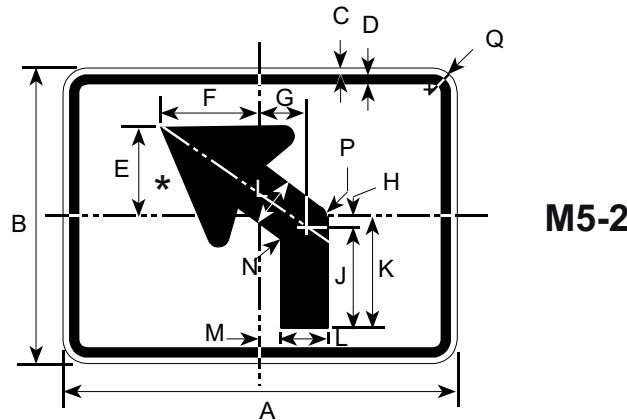

Road Class	Dimensions (inches)															
	A	B	C	D	E	F	G	H	J	K	L	M	N	P	Q	
Minimum	21	15	0.38	0.63	4.75	4.5	2.44	0.75	4.0	5.44	2.63	1.13	0.38	0.6	1.5	

M6-1 M6-2

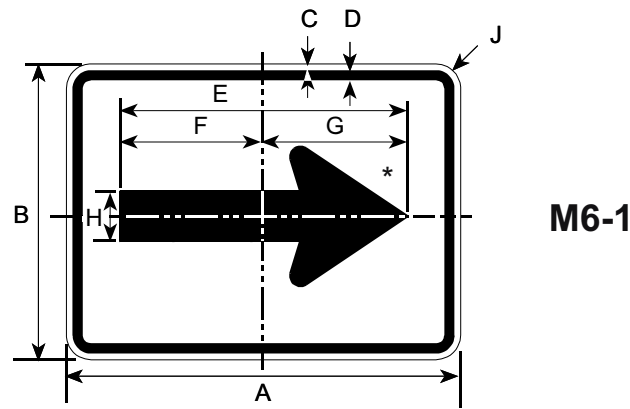

Road Class	Dimensions (inches)								
	A	B	C	D	E	F	G	H	J
Conv & Min	21	15	0.38	0.63	14.63	7.13	7.5	2.63	1.5

Border and Legend: Black, Blue, Green, or Brown
Background: White

* See Appendix B-1 for Standard Arrow Details.

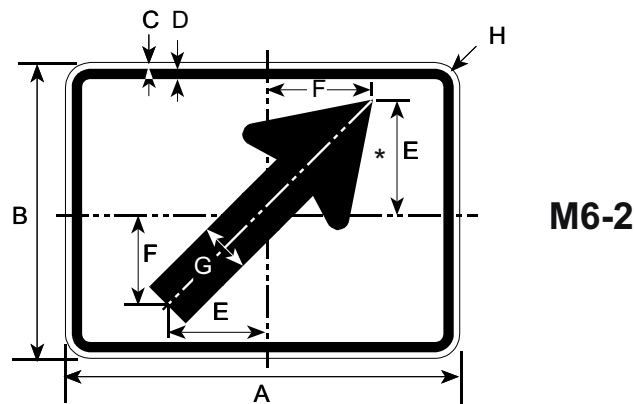

Road Class	Dimensions (inches)							
	A	B	C	D	E	F	G	H
Conv & Min	21	15	0.38	0.63	5.06	5.63	2.63	1.5

M6-3 M6-4

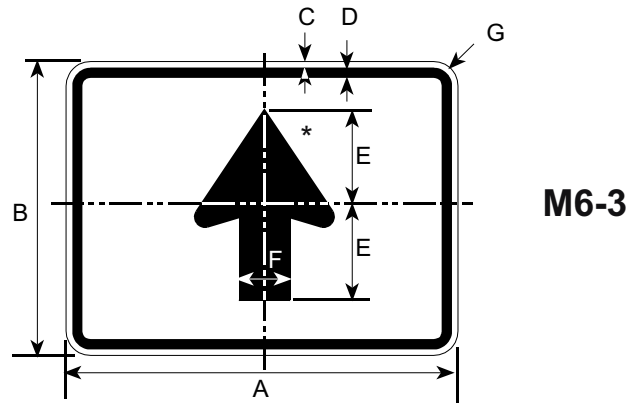

Road Class	Dimensions (inches)						
	A	B	C	D	E	F	G
Conv & Min	21	15	0.38	0.63	4.88	2.63	1.5

Border and Legend: Black, Blue, Green, or Brown
Background: White

* See Appendix B-1 for Standard Arrow Details.

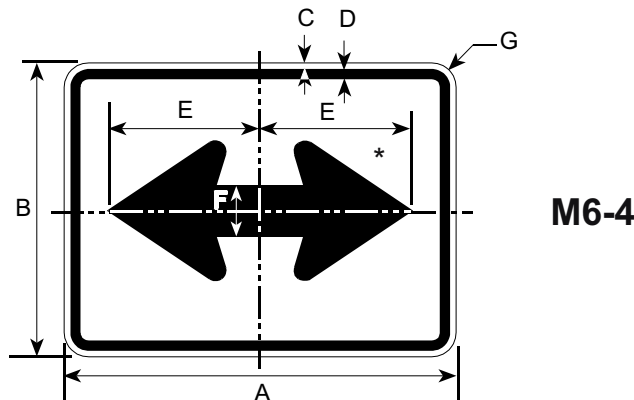

Road Class	Dimensions (inches)						
	A	B	C	D	E	F	G
Conv & Min	21	15	0.38	0.63	7.5	2.63	1.5

M6-5 M6-6

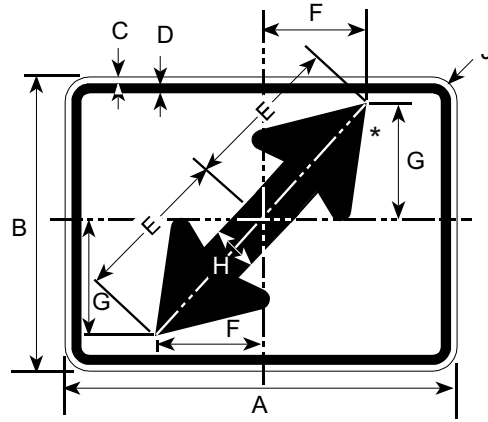

M6-5

Road Class	Dimensions (inches)									
	A	B	C	D	E	F	G	H	J	
Conv & Min	21	15	0.38	0.63	7.88	5.88	5.25	2.25	1.5	

Border and Legend: Black, Blue, Green, or Brown
Background: White

* See Appendix B-1 for Standard Arrow Details.

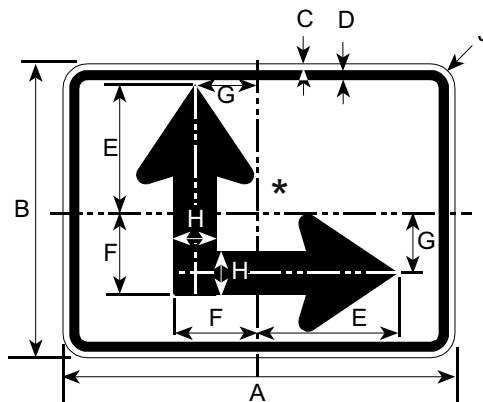

M6-6

Road Class	Dimensions (inches)									
	A	B	C	D	E	F	G	H	J	
Conv & Min	21	15	0.38	0.63	5.75	3.88	2.75	2.25	1.5	

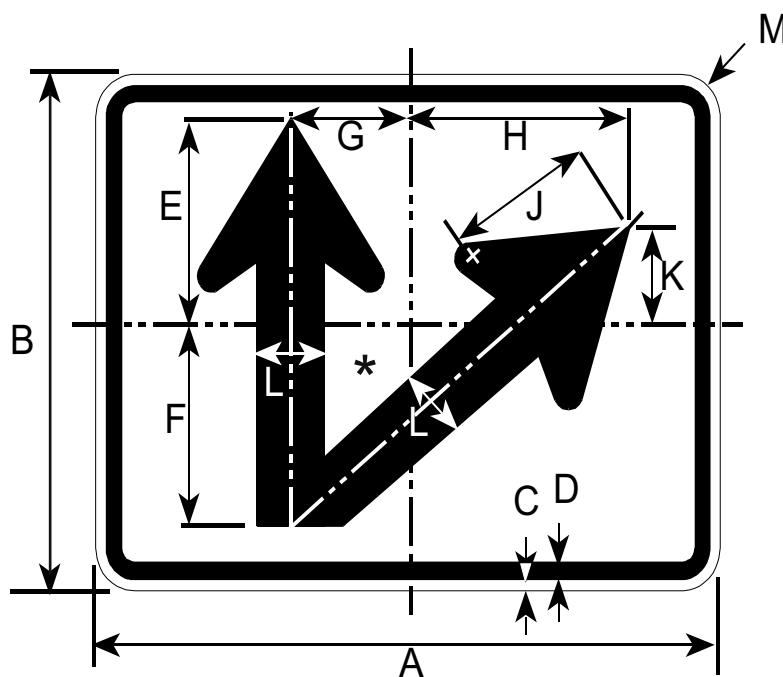

Border and Legend: Black, Blue, Green, or Brown
 Background: White

* See Appendix B-1 for Standard Arrow Details.

Road Class	Dimensions (inches)											
	A	B	C	D	E	F	G	H	J	K	L	M
Conv & Min	21	15	0.38	0.63	5.75	5.5	3.88	6.75	4.5	2.13	2.25	1.5

M6-8 M6-9

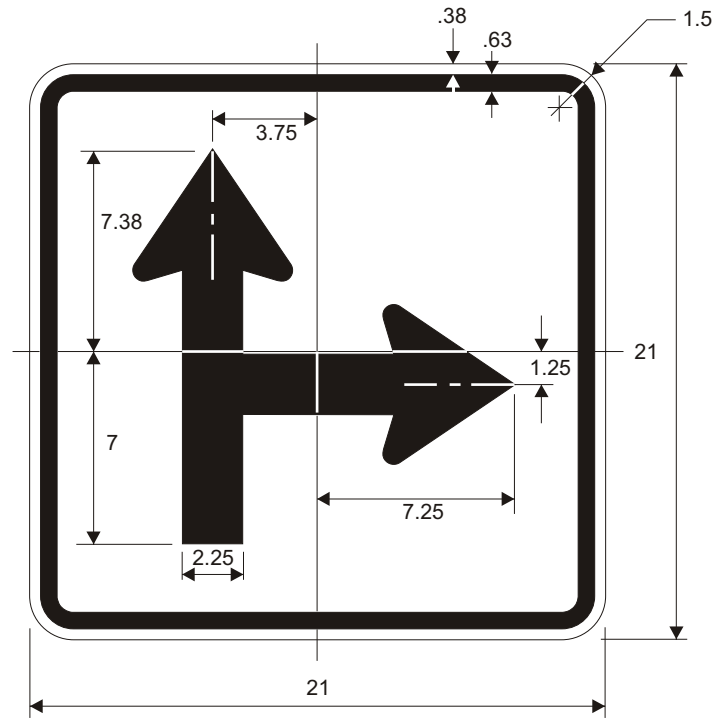

M6-8

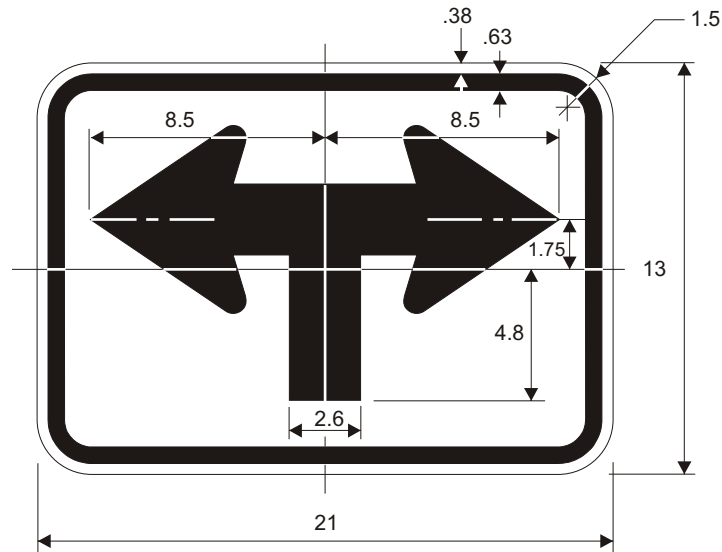

M6-9

* See Appendix B-1 for Standard Arrow Details.

Border and Legend: Black, Blue, Green, or Brown
Background: White

M7-1 M7-2 M7-3

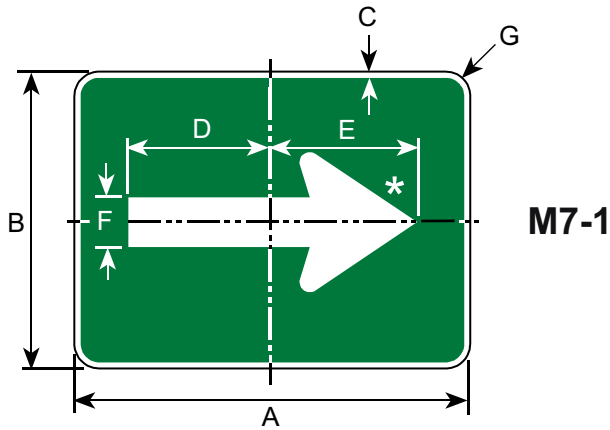

Road Class	Dimensions (inches)						
	A	B	C	D	E	F	G
Bike	12	9	0.38	4.25	4.5	1.63	1.5

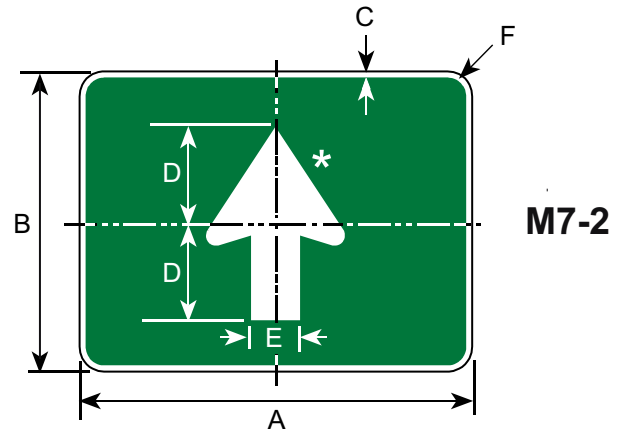

Road Class	Dimensions (inches)					
	A	B	C	D	E	F
Bike	12	9	0.38	3.0	1.63	1.5

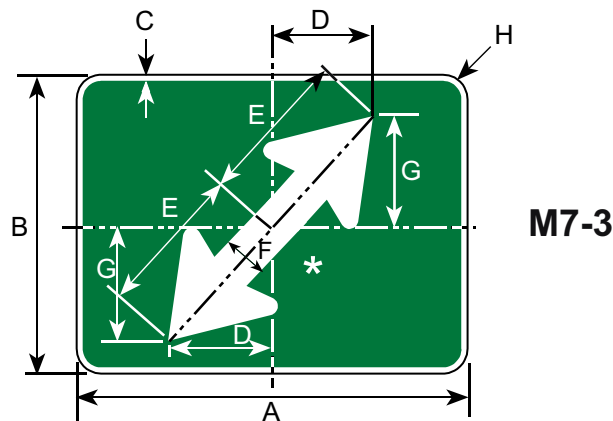

Road Class	Dimensions (inches)							
	A	B	C	D	E	F	G	H
Bike	12	9	0.38	3.63	4.5	1.38	3.0	1.5

Border and Legend: White
Background: Green

* See Appendix B-1 for Standard Arrow Details.

M7-4
M7-5
M7-6
M7-7

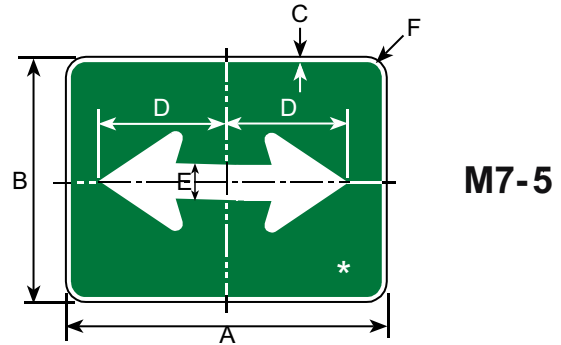
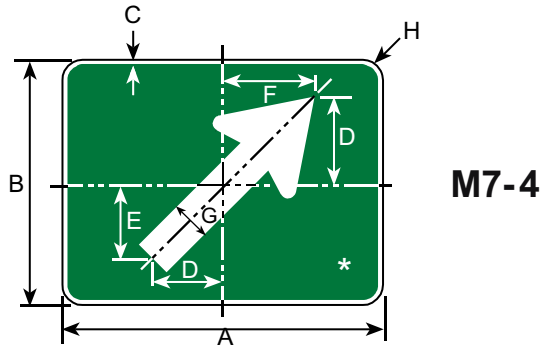

Road Class	Dimensions (inches)							
	A	B	C	D	E	F	G	H
Bike	12	9	0.38	3.0	2.63	3.38	1.63	1.5

Road Class	Dimensions (inches)					
	A	B	C	D	E	F
Bike	12	9	0.38	4.38	1.63	1.5

Border and Legend: White
 Background: Green

* See Appendix B-1 for Standard Arrow Details.

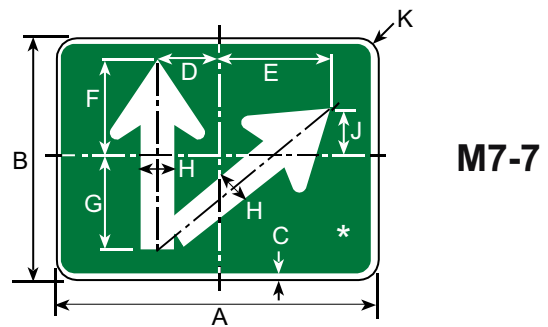
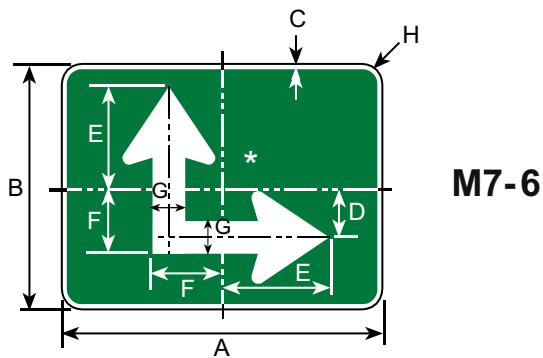

Road Class	Dimensions (inches)							
	A	B	C	D	E	F	G	H
Bike	12	9	0.38	1.63	3.38	2.25	1.38	1.5

Road Class	Dimensions (inches)									
	A	B	C	D	E	F	G	H	J	K
Bike	12	9	0.38	2.25	4.0	3.38	3.13	1.38	1.25	1.5

M11-1

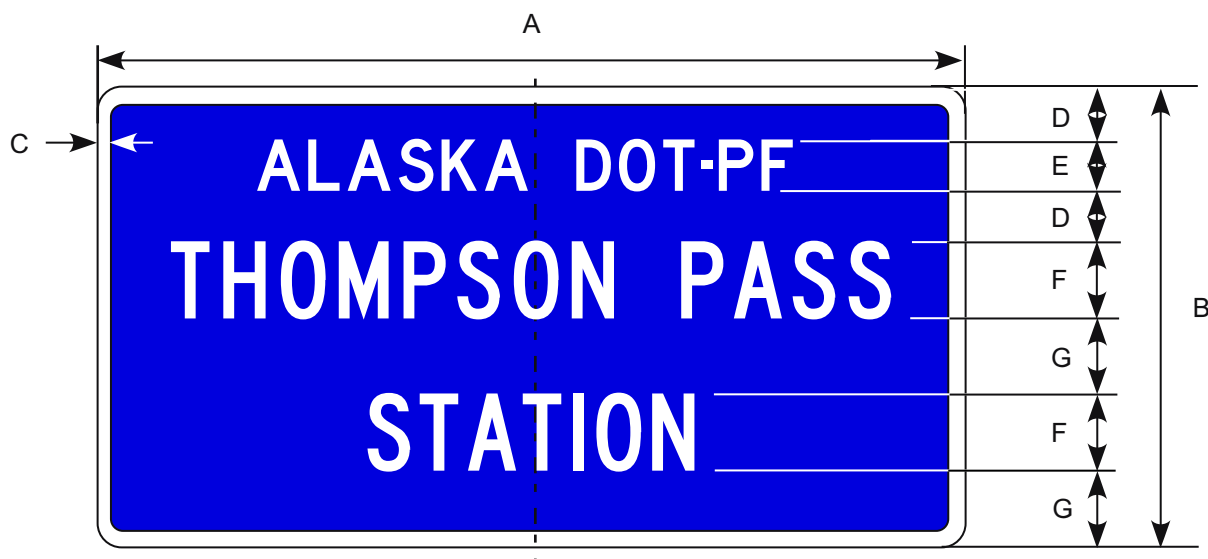

Border and Legend: White
Background: Blue

Road Class	Dimensions (inches)						
	A	B	C	D	E	F	G
Conventional	Variable	36	1	4	4D	6C	6

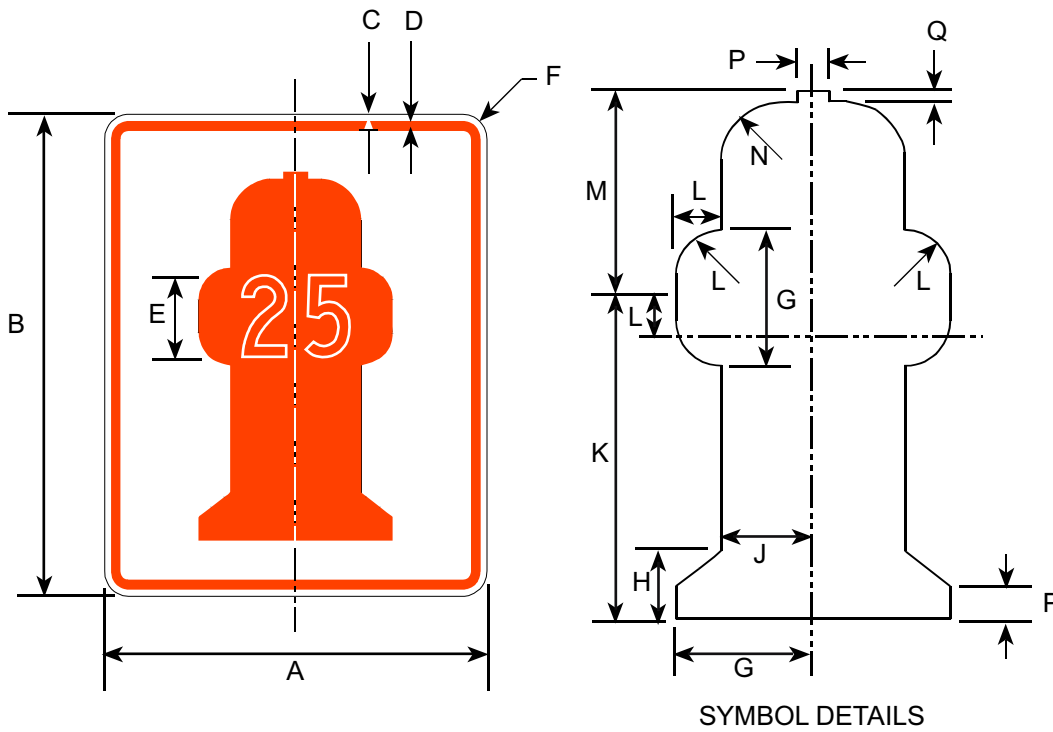

Border and Symbol: Red
Background: White

Road Class	Dimensions (inches)														
	A	B	C	D	E	F	G	H	J	K	L	M	N	P	Q
Conv & Min	24	30	0.38	0.63	5C	1.5	6	3	4	13	2	9	2.5	1.5	0.5

OBJECT MARKERS

OM1-1 to OM4-3

OM1-1
OM1-2
OM1-3

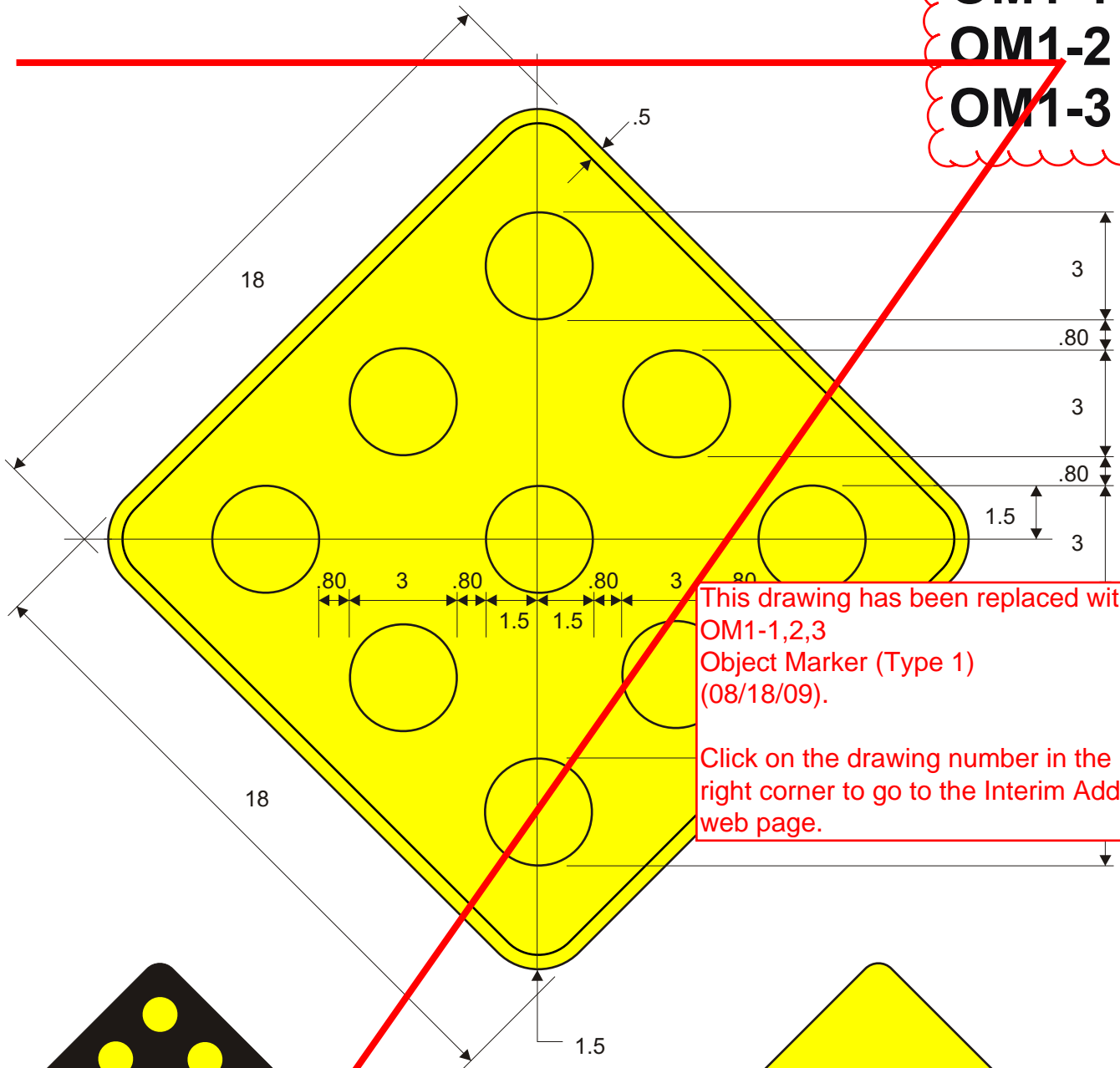

This drawing has been replaced with
 OM1-1,2,3
 Object Marker (Type 1)
 (08/18/09).
 Click on the drawing number in the upper
 right corner to go to the Interim Addenda
 web page.

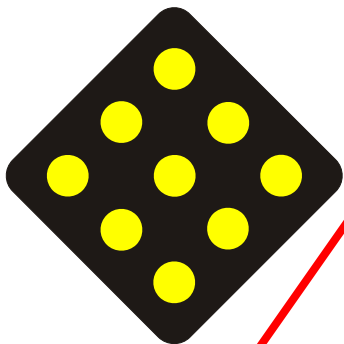

OM1-2

OM1-2 COLORS:
 Reflectors: Yellow
 Background: Black

OM1-1

OM1-1 COLORS:
 Reflectors: Yellow
 Background: Yellow
 Border: Yellow

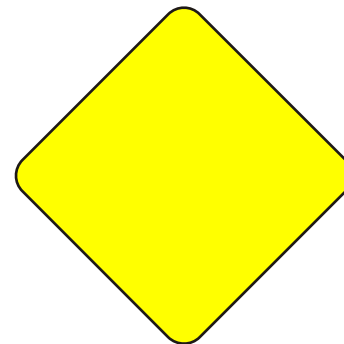

OM1-3

OM1-3 COLORS:
 Sign Panel: Yellow

**OM2-1H
OM2-1V
OM2-2H
OM2-2V**

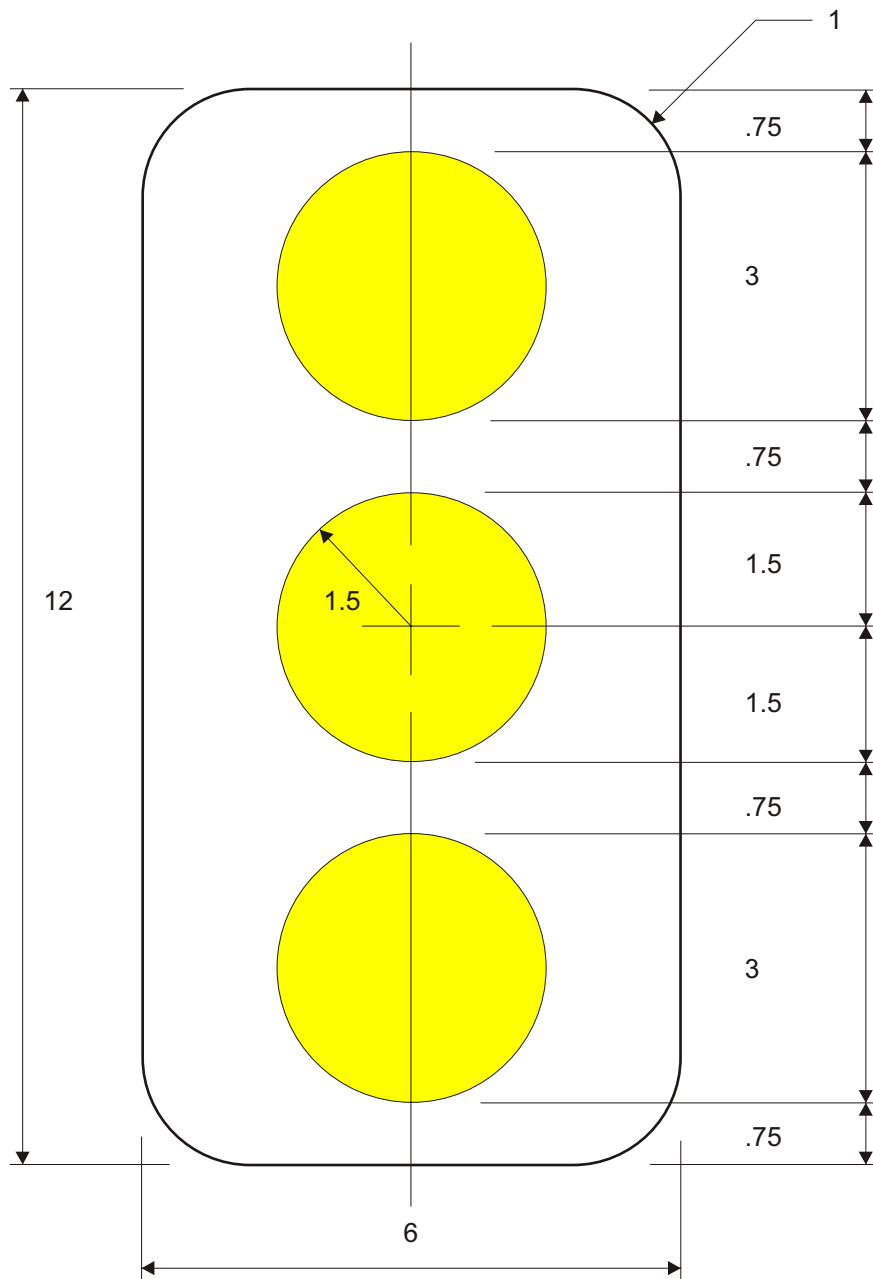

OM2-1V

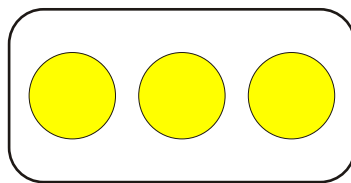

OM2-1H

OM2-1 COLORS:
Reflectors: Yellow
Background: White



OM2-2V



OM2-2H

OM2-2 COLORS:
Sign Panel: Yellow

OM-3L
OM-3C
OM-3R

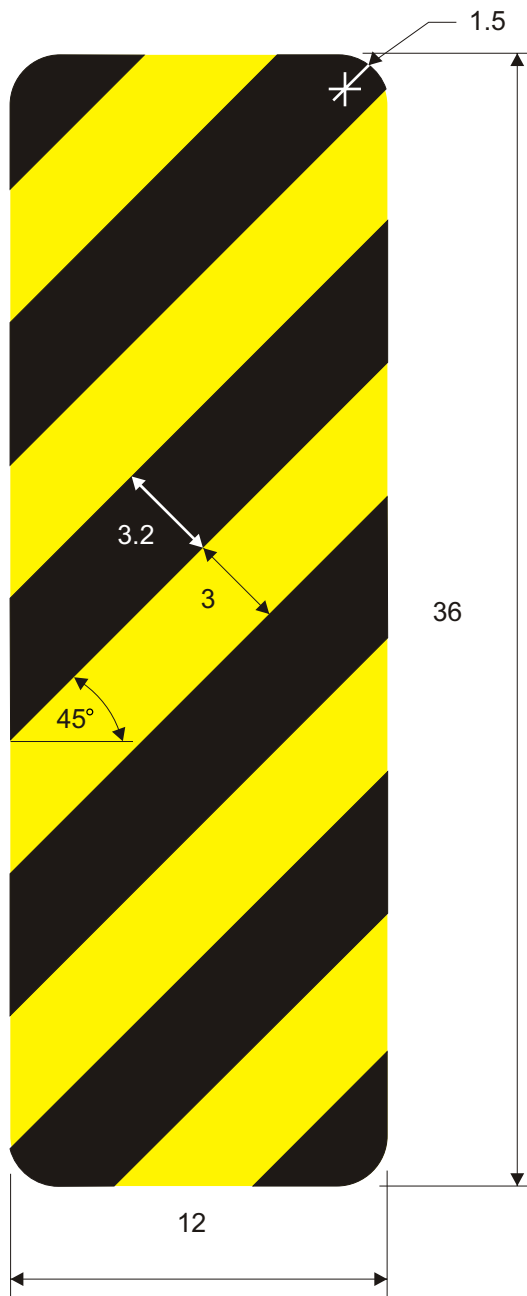

OM-3R

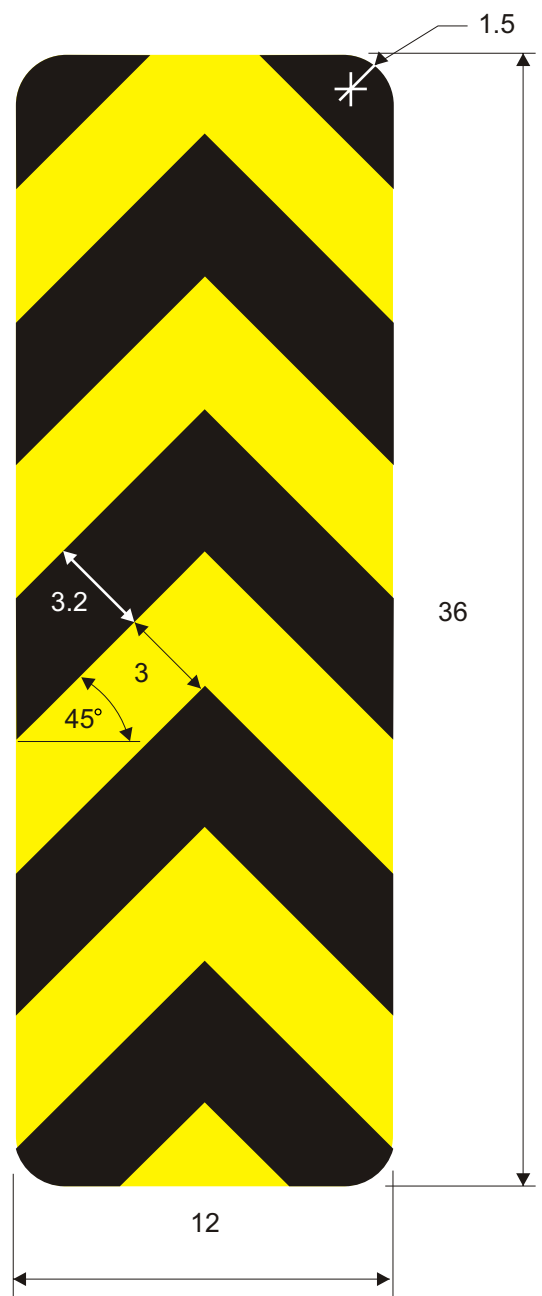

OM-3C



OM-3L

Stripes: Black
Background: Yellow

OM4-1
OM4-2
OM4-3

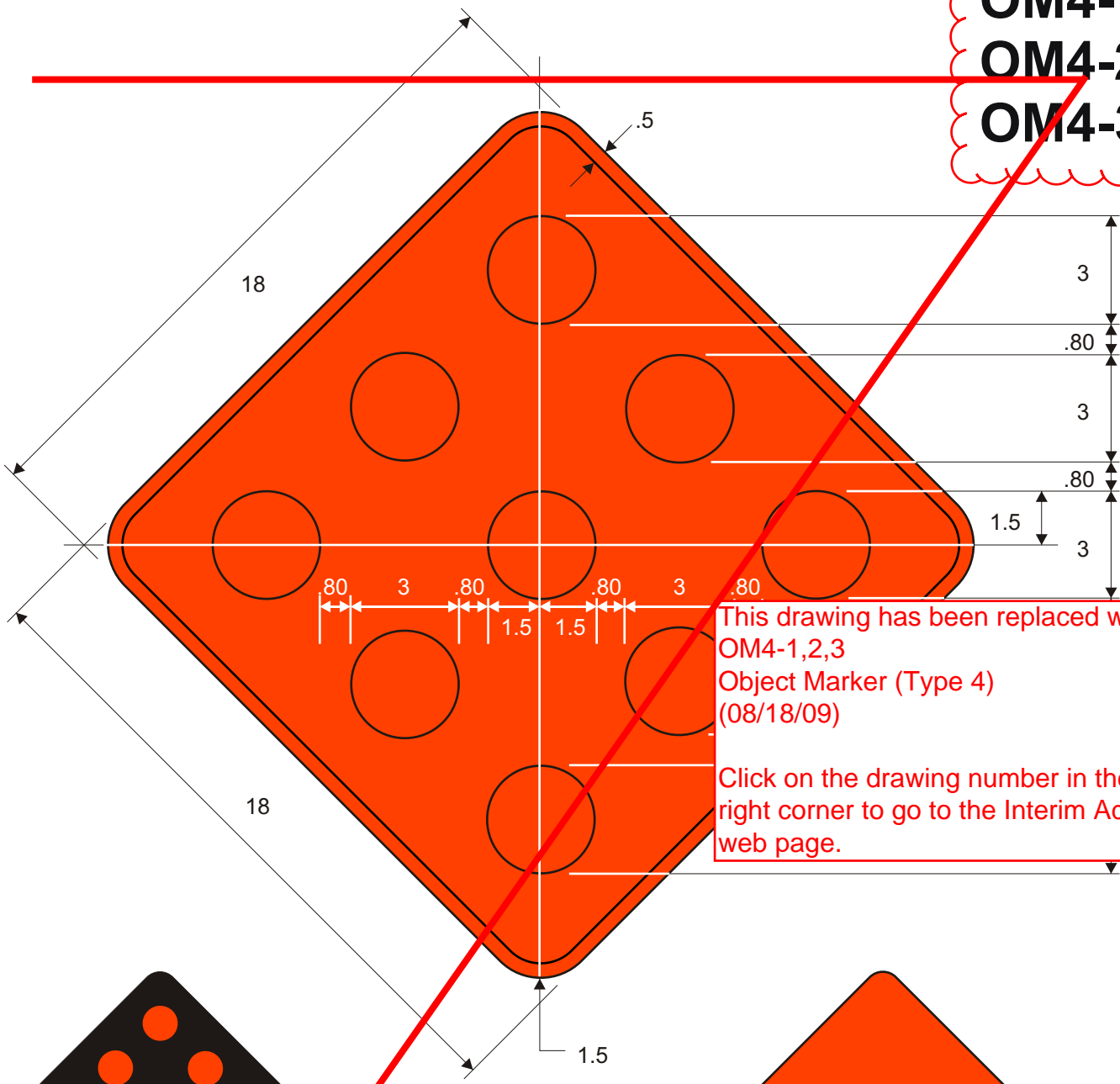

This drawing has been replaced with:
 OM4-1,2,3
 Object Marker (Type 4)
 (08/18/09)

Click on the drawing number in the upper right corner to go to the Interim Addenda web page.

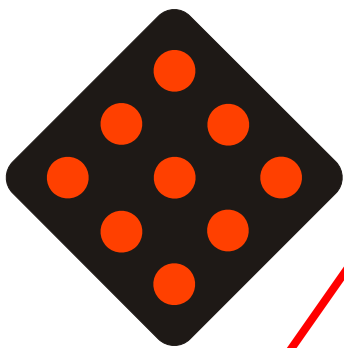

OM4-2

OM4-2 COLORS:
 Reflectors: Red
 Background: Black

OM4-1

OM4-1 COLORS:
 Reflectors: Red
 Background: Red
 Border: Red

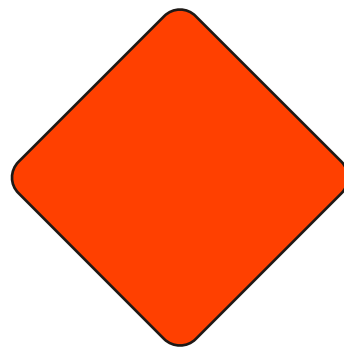

OM4-3

OM4-3 COLORS:
 Sign Panel: Red

REGULATORY SIGNS

R1-1 to R16-115

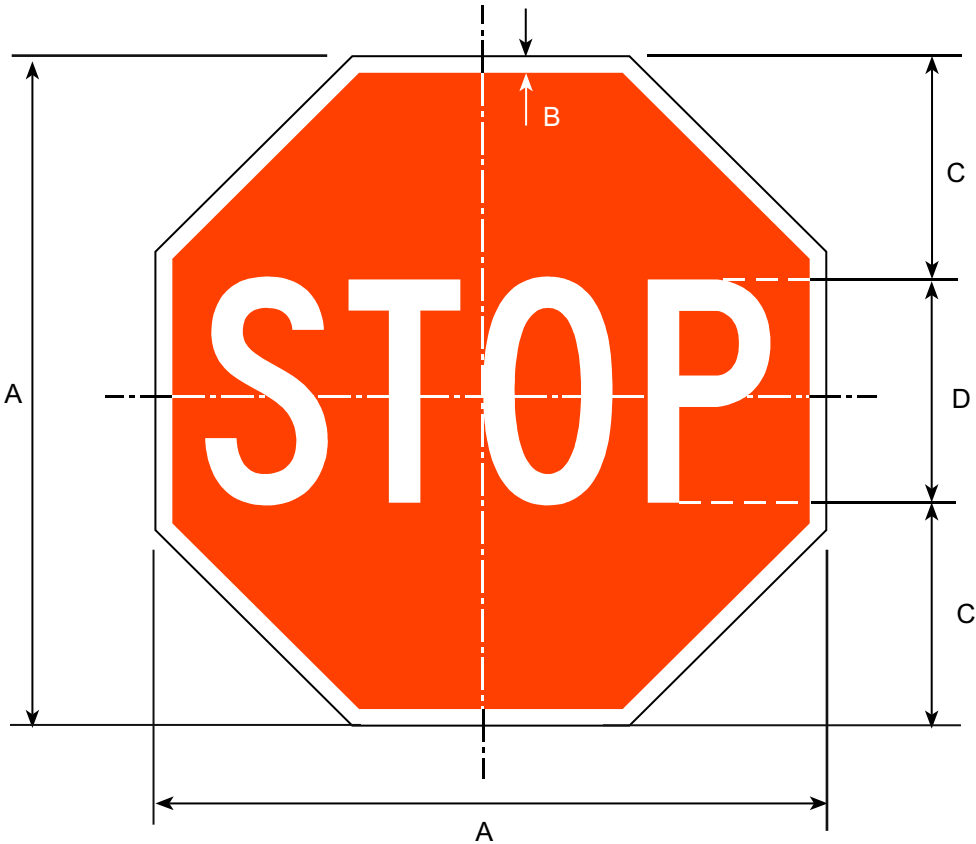

Border and Legend: White
Background: Red

Road Class	Dimensions (inches)			
	A	B	C	D
Bike	18	0.38	6	6C
Minimum	24	0.63	8	8C
Conventional	30	0.75	10	10C
Expressway	36	0.88	12	12C
Oversized	48	1.25	16	16C

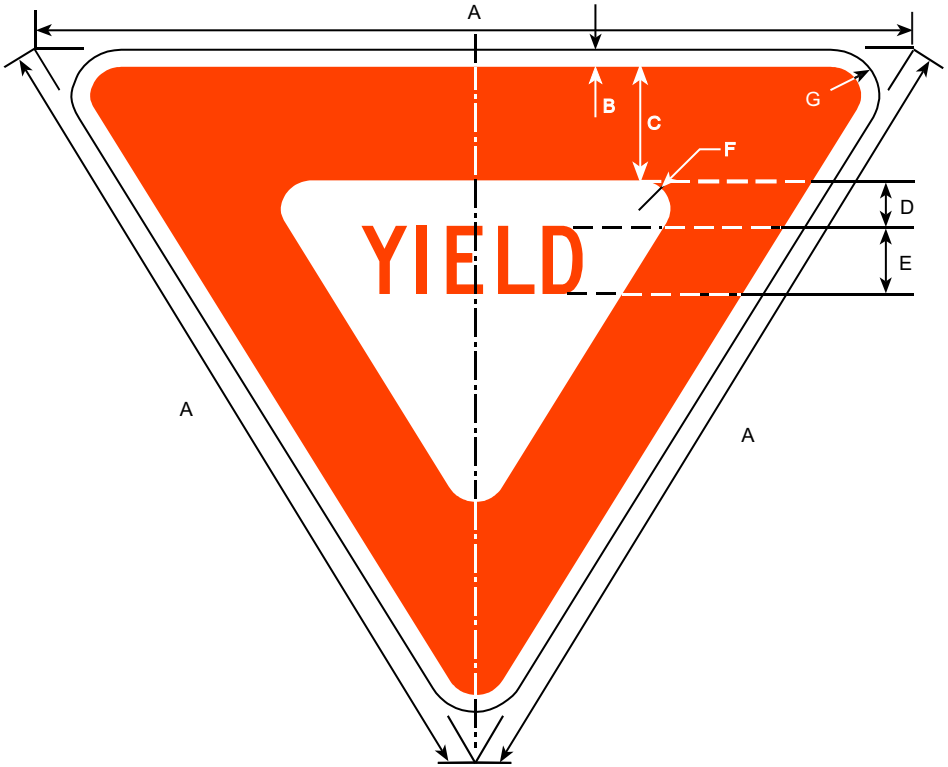

Margin and Central Background: White
Outer Background and Legend: Red

Road Class	Dimensions (inches)						
	A	B	C	D	E	F	G
Bike	24	0.38	3	1.38	2C	0.88	1.50
Minimum	30	0.63	4	1.75	2 1/2C	0.88	1.50
Conventional	36	0.75	5	2.00	3C	1.25	2.00
Expressway	48	1.00	6	2.75	4C	2.00	3.00
Oversized	60	1.50	8	3.50	5C	2.50	4.00

R1-2A

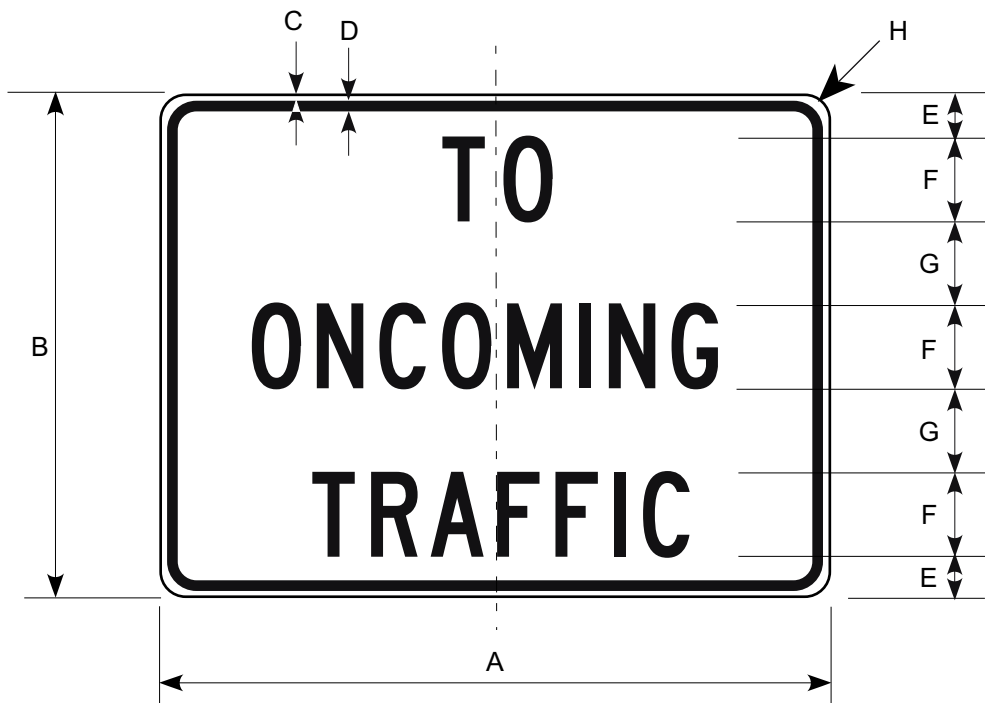

Border and Legend: Black
Background: White

Road Class	Dimensions (inches)							
	A	B	C	D	E	F	G	H
Conv & Min	24	18	0.5	0.75	1.5	3C	3	1.5

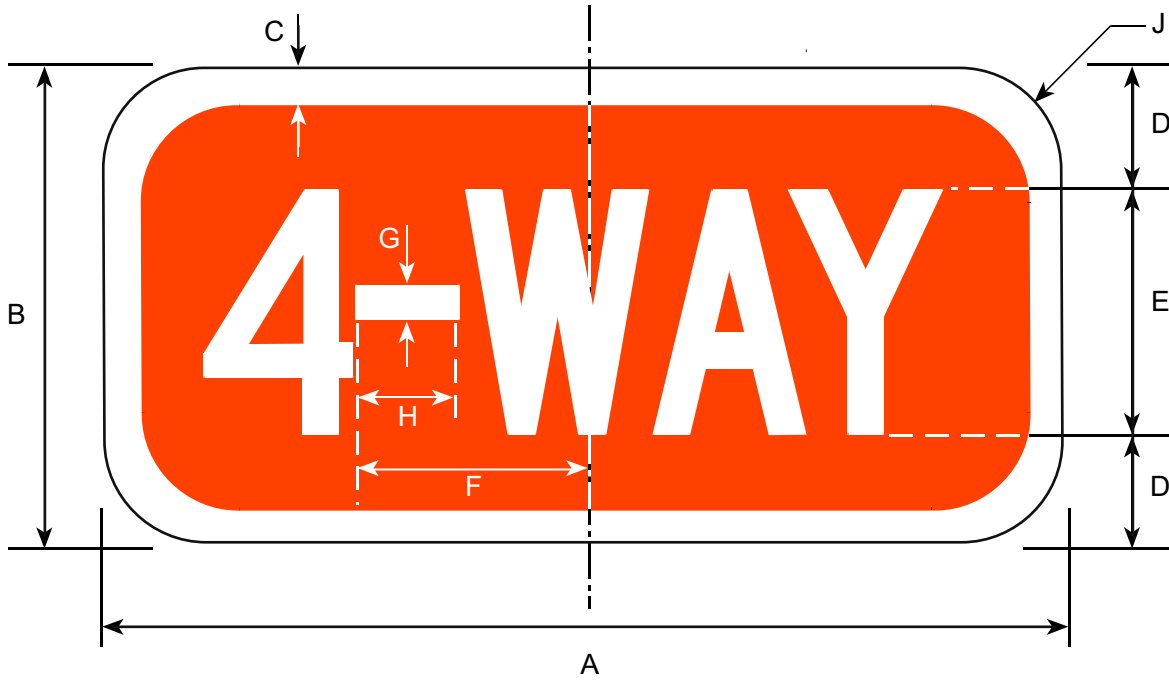

Border and Legend: White
Background: Red

Class	Dimensions (inches)								
	A	B	C	D	E	F	G	H	J
Conv & Min	12	6	0.50	1.50	3C	2.75	0.42	1.06	1.50



Border and Legend: White
Background: Red

Road Class	Dimensions (inches)					
	A	B	C	D	E	F
Conv & Min	18	6	0.50	1.50	3C	1.50

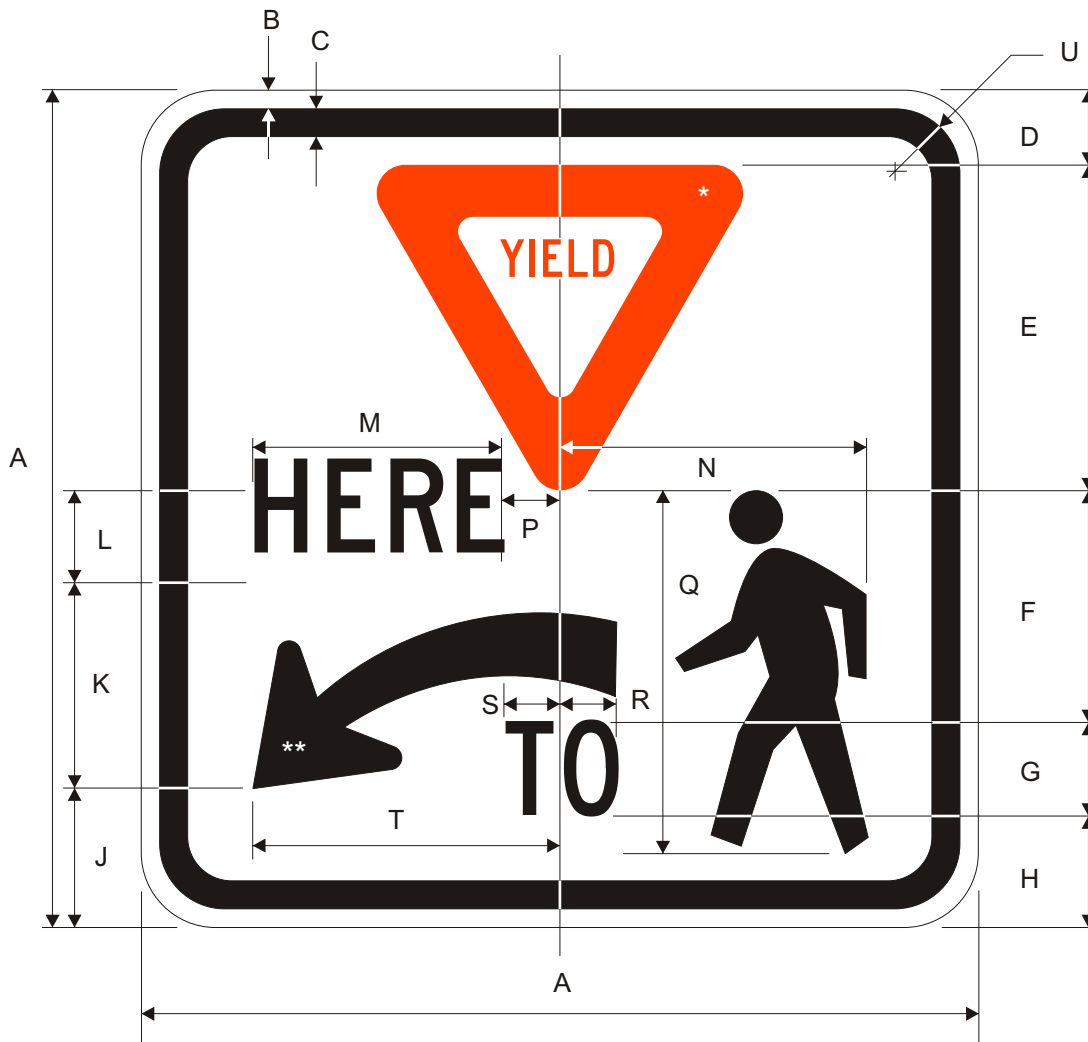

Road Class	Dimensions (inches)										
	A	B	C	D	E	F	G	H	J	K	L
Bike	18	0.38	0.63	1.62	7.0	5.0	2C	2.38	3.0	4.38	2C
Min	30	0.50	0.75	2.75	11.5	8.5	3C	4.25	5.0	7.25	3C
Conv.	36	0.63	0.88	3.25	14	10	4C	4.75	6.0	8.75	4C

M	N	P	Q	R	S	T	U
5.36	6.61	1.24	7.81	1.22	1.22	6.61	1.5
8.06	11	2.0	13	1.82	1.82	11	1.88
10.73	13.21	2.48	15.61	2.44	2.44	13.21	2.25

Legend and Arrow: Black
 Ped Symbol: Black
 Background: White
 Yield Symbol: Red

*Insert R1-2 and size to fit.
 **See Appendix B-1 for Standard Arrow Details.

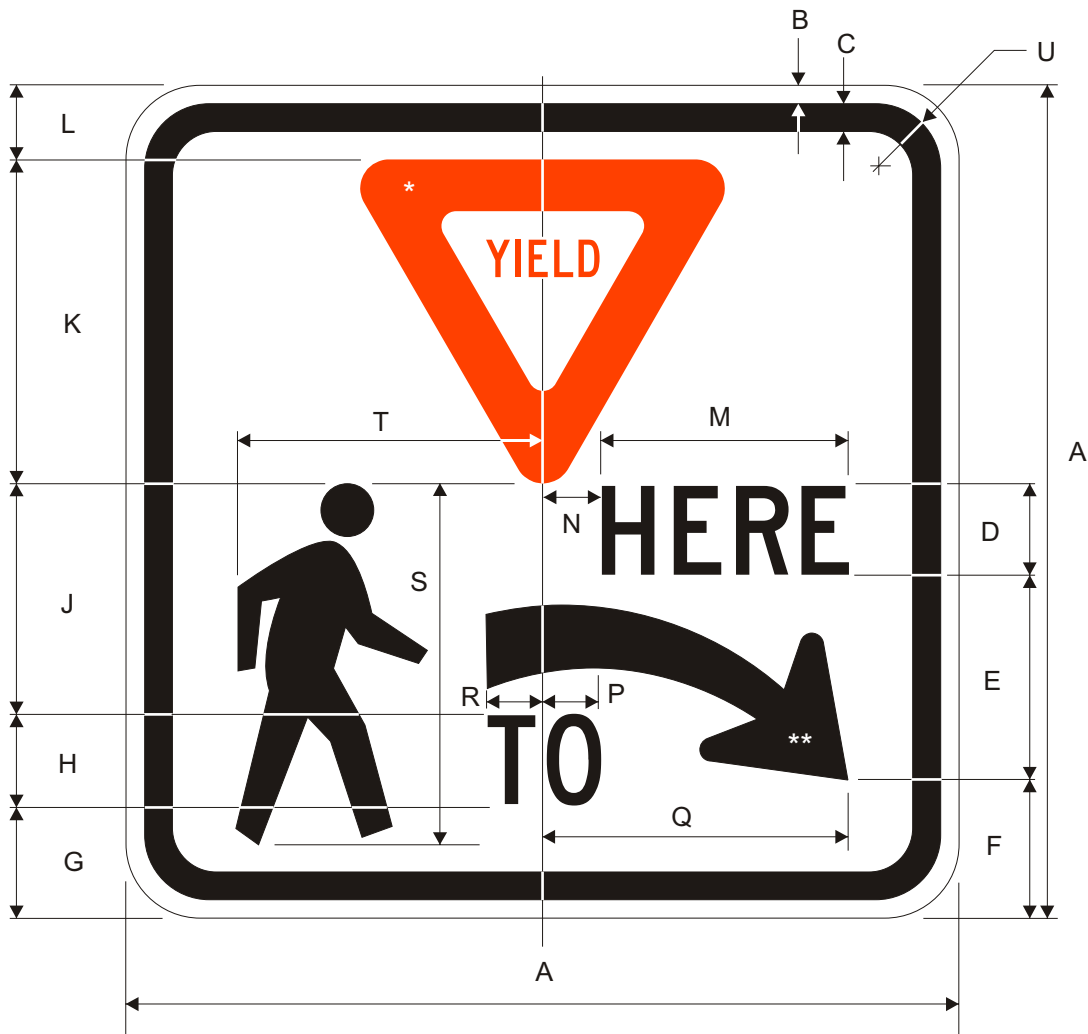

Road Class	Dimensions (inches)										
	A	B	C	D	E	F	G	H	J	K	L
Bike	18	0.38	0.63	2C	4.38	3.0	2.38	2C	5.0	7.0	1.62
Min.	30	0.50	0.75	3C	7.25	5.0	4.25	3C	8.5	11.5	2.75
Conv.	36	0.63	0.88	4C	8.75	6.0	4.75	4C	10	14	3.25

M	N	P	Q	R	S	T	U
5.36	1.24	1.22	6.61	1.22	7.81	6.61	1.5
8.06	2.0	1.82	11	1.82	13	11	1.88
10.73	2.48	2.44	13.21	2.44	15.61	13.21	2.25

*Insert R1-2 and size to fit.

**See Appendix B-1 for Standard Arrow Details.

Legend and Arrow: Black
 Ped Symbol: Black
 Background: White
 Yield Symbol: Red

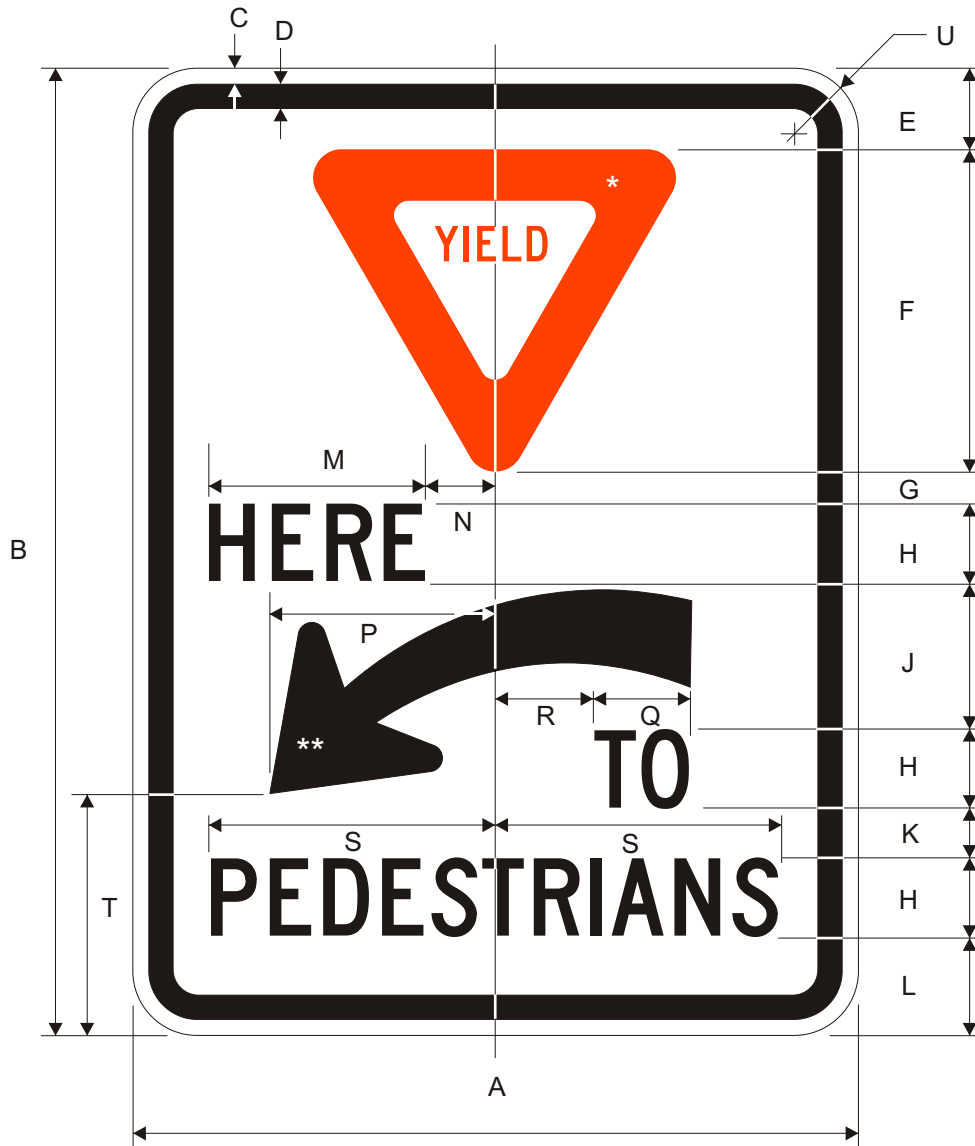

Road Class	Dimensions (inches)										
	A	B	C	D	E	F	G	H	J	K	L
Bike	18	24	0.38	0.63	2.0	8.0	0.75	2C	3.62	1.25	2.38
Min.	30	42	0.50	0.75	5.0	13.5	1.25	3C	6.0	2.0	5.25
Conv.	36	48	0.63	0.88	4.0	16	1.5	4C	7.25	2.5	4.75

M	N	P	Q	R	S	T	U
5.36	1.76	5.60	2.43	2.40	7.125	6.0	1.50
8.06	2.62	9.38	3.64	4.36	10.68	10	1.88
10.74	3.52	11.2	4.85	4.85	14.24	12	2.25

Legend and Arrow: Black
 Background: White
 Yield Symbol: Red

*Insert R1-2 and size to fit.
 **See Appendix B-1 for Standard Arrow Details.

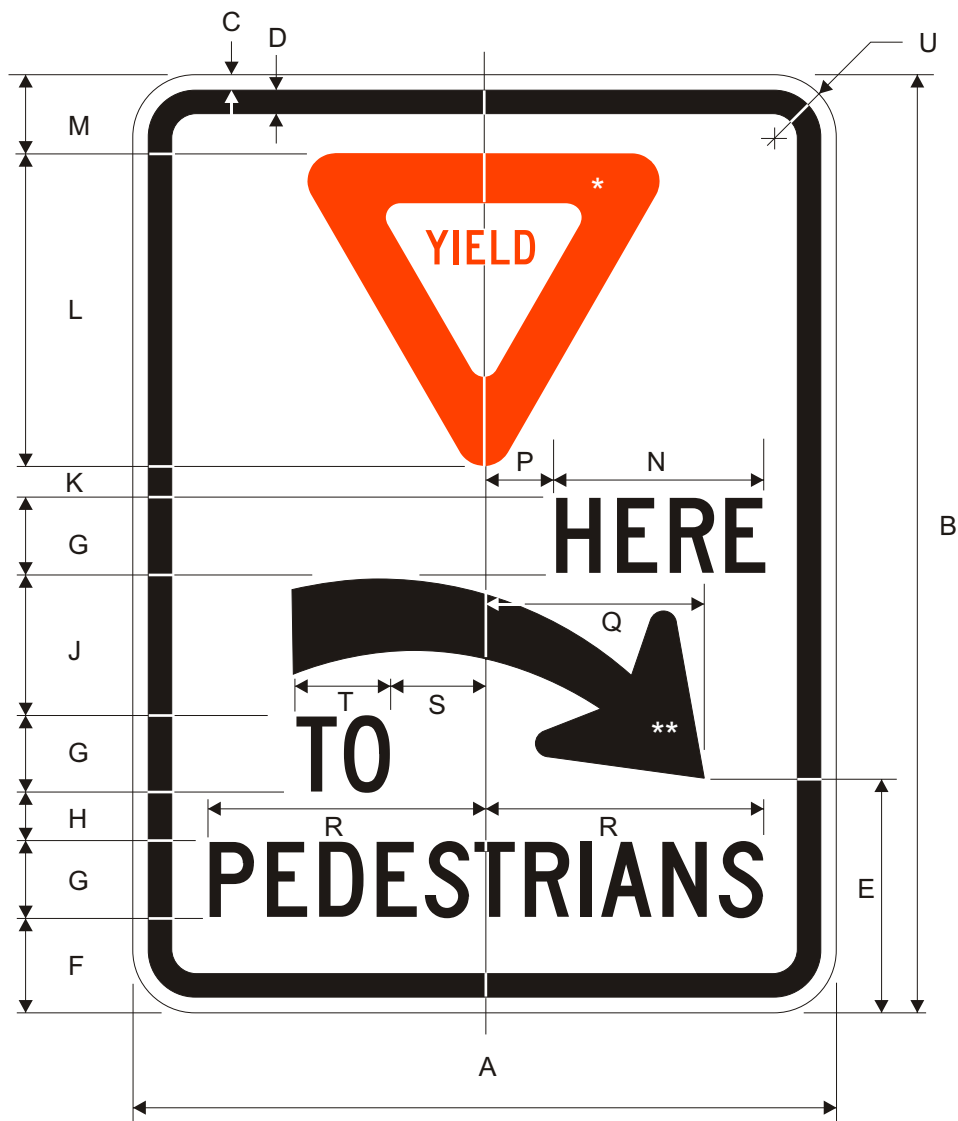

Road Class	Dimensions (inches)										
	A	B	C	D	E	F	G	H	J	K	L
Bike	18	24	0.38	0.63	6.0	2.38	2C	1.25	3.62	0.75	8.0
Min.	30	42	0.50	0.75	10	5.25	3C	2.0	6.0	1.25	13.5
Conv.	36	48	0.63	0.88	12	4.75	4C	2.5	7.25	1.5	16

M	N	P	Q	R	S	T	U
2.0	5.36	1.8	5.6	7.13	2.40	2.43	1.50
5.0	8.1	2.6	9.4	10.7	4.36	3.64	1.88
4.0	10.74	3.5	11.2	14.2	4.80	4.85	2.25

Legend and Arrow: Black
 Background: White
 Yield Symbol: Red

*Insert R1-2 and size to fit.

**Insert R10-6a Arrow and reduce to fit.

R1-6

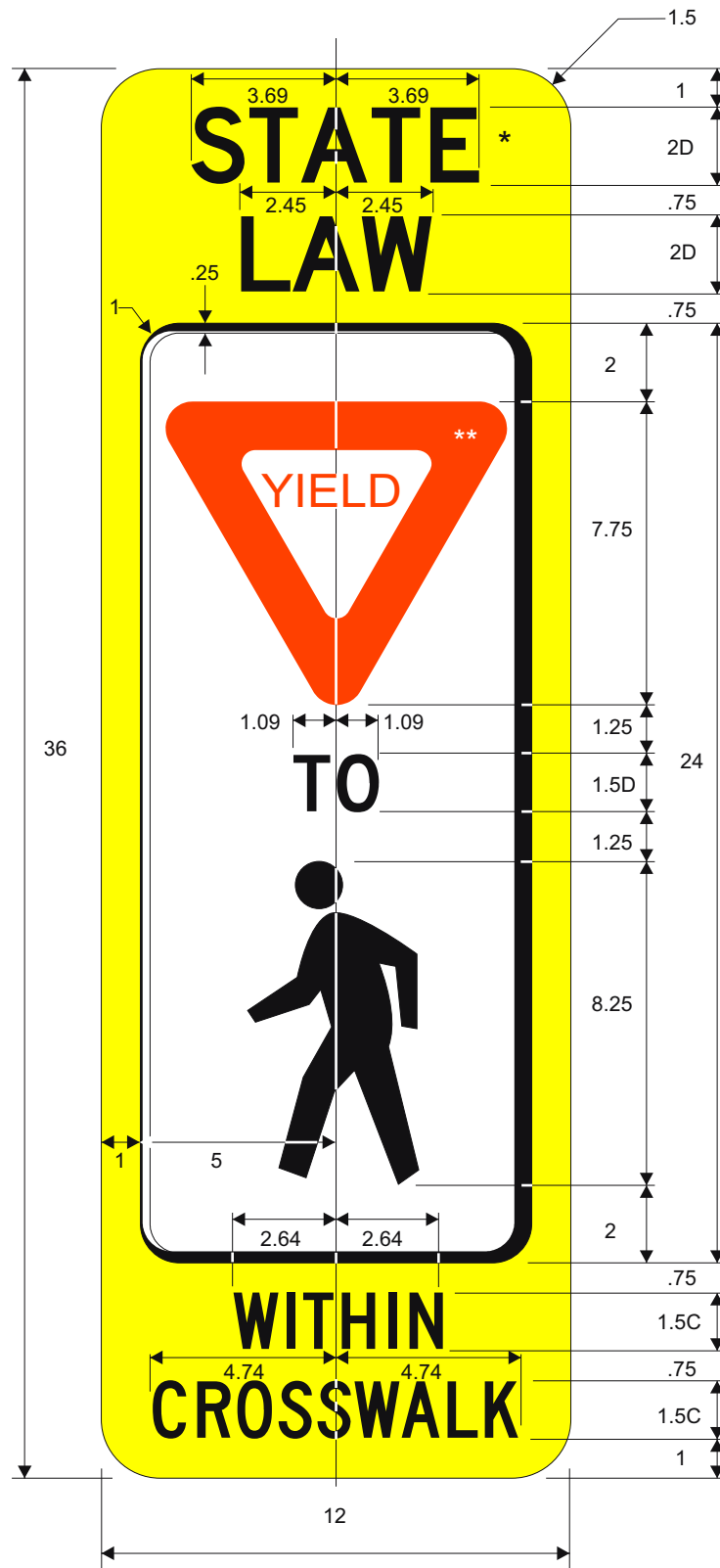

*Legend is optional.

**Insert R1-2 and size to fit.

Legend: Black
 Background: Yellow
 Yield Symbol: Red
 Ped Symbol: Black on White

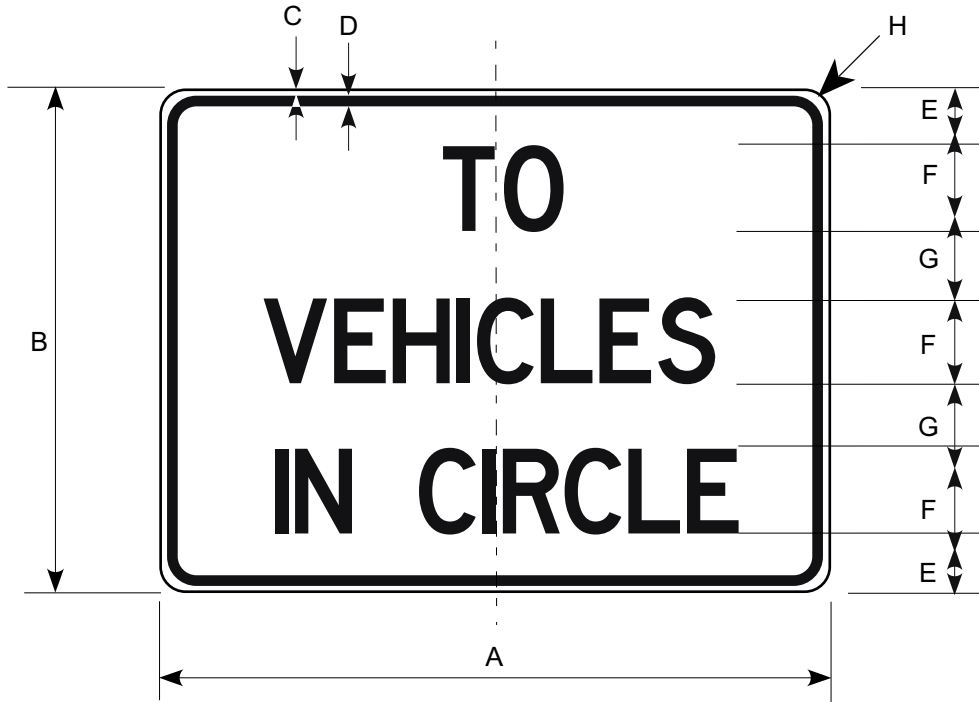

Border and Legend: Black
Background: White

Road Class	Dimensions (inches)							
	A	B	C	D	E	F	G	H
Conv & Min	24	18	0.5	0.75	1.5	3D	3	1.5



Border and Legend: Black
 Background: White

Road Class	Dimensions (inches)								
	A	B	C	D	E	F	G	H	J
Minimum	24	30	0.38	0.63	4.0	4E	2.0	10E	1.5
Conventional	30	36	0.50	0.75	4.0	5E	3.0	12E	1.88
Expressway	36	48	0.63	0.88	6.0	6E	5.0	14E	2.25
Freeway	48	60	0.75	1.25	8.0	8E	6.0	16E	3.0

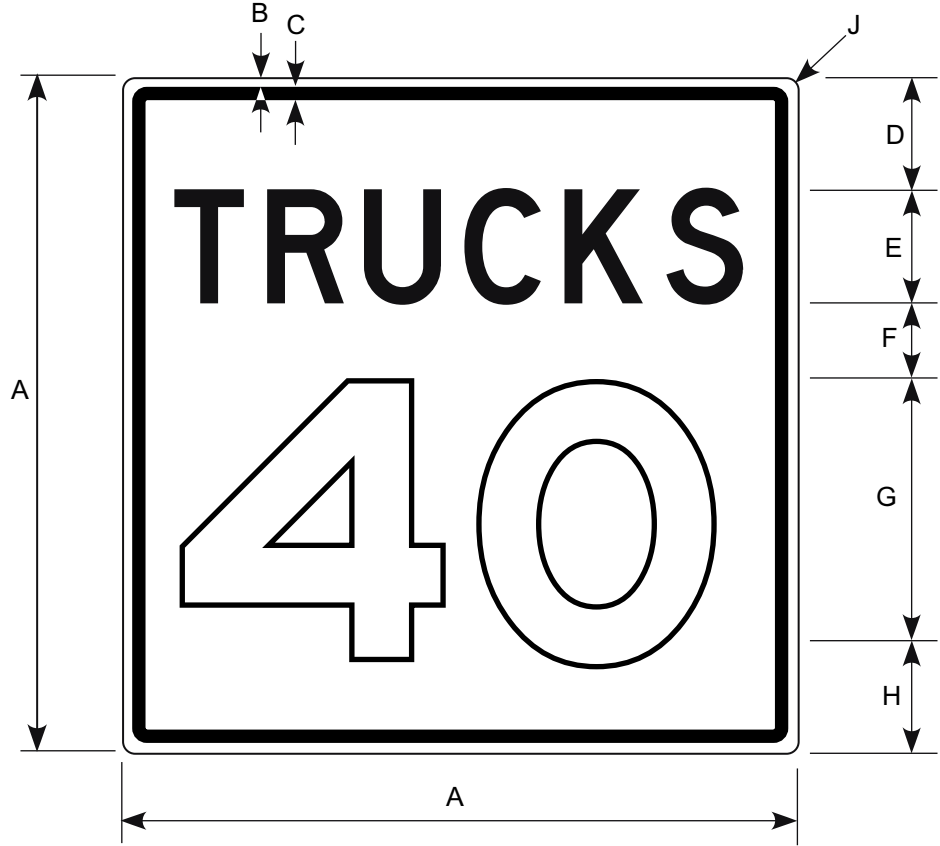

Border and Legend: Black
Background: White

Road Class	Dimensions (inches)								
	A	B	C	D	E	F	G	H	J
Minimum	24	0.38	0.63	4.0	4D	2.5	10E	3.5	1.5
Conventional	36	0.63	0.88	6.0	6D	4.0	14E	6.0	2.25
Expwy/Fwy	48	0.75	1.25	8.0	8D	8.0	16E	8.0	3.0

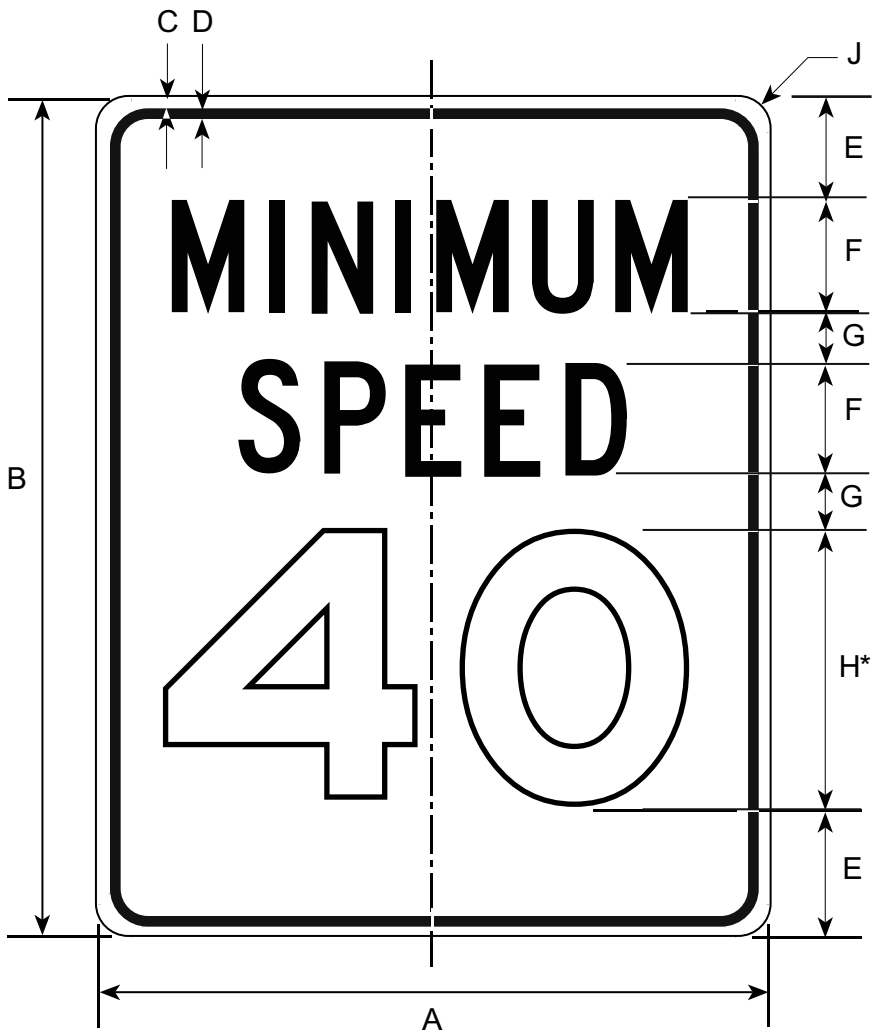

Border and Legend: Black
 Background: White

* Speed limit is variable.

Road Class	Dimensions (inches)								
	A	B	C	D	E	F	G	H	J
Conv & Min	24	30	0.38	0.63	4	4C	2	10D	1.50
Expressway	36	48	0.63	0.88	6	6C	5	14D	2.25
Freeway	48	60	0.75	1.25	8	8C	6	16D	3.00

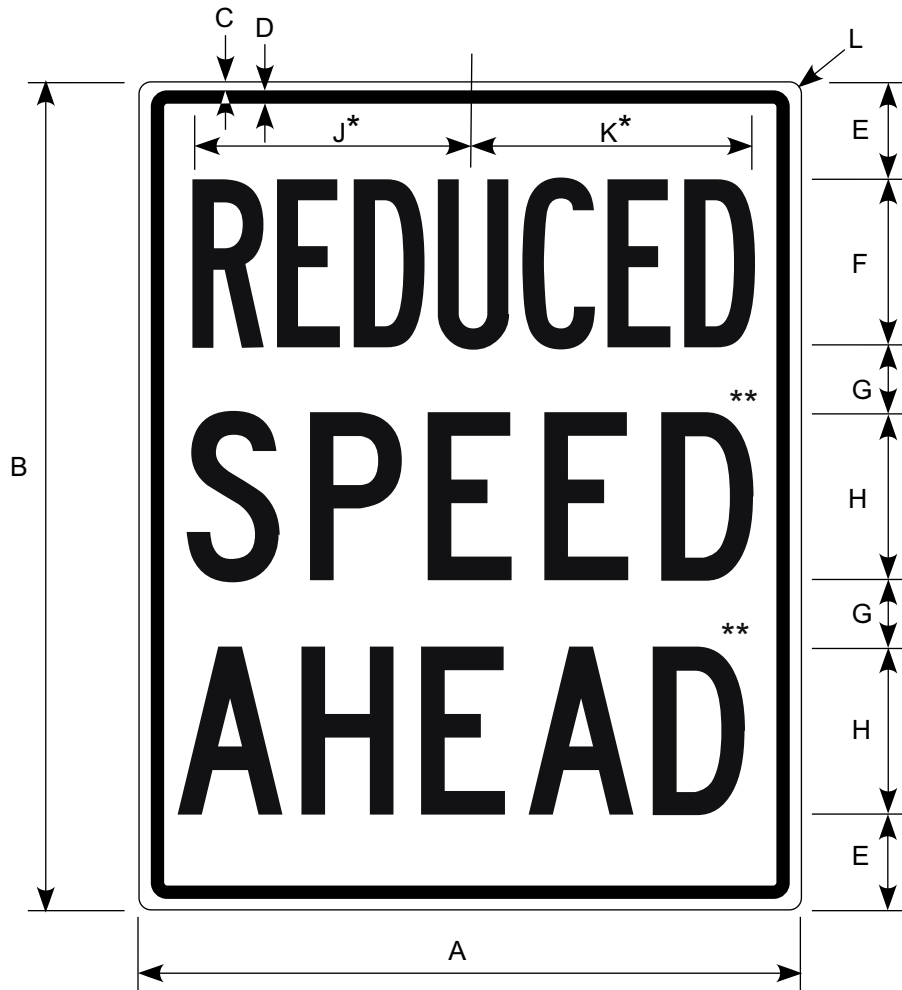

Border and Legend: Black
Background: White

* Reduce letter spacing 50% for Conventional size and 25% for other sizes.

** Reduce letter spacing 40% for Conventional size.

Road Class	Dimensions (inches)										
	A	B	C	D	E	F	G	H	J	K	L
Minimum	18	24	0.38	0.63	3.50	4B	2.5	4C	6.88	7.00	1.50
Conventional	24	30	0.38	0.63	3.50	6B	2.5	6C	10.00	10.19	1.50
Expressway	36	48	0.63	0.88	7.00	8B	5.0	8C	14.25	14.75	2.25
Freeway	48	60	0.75	1.25	9.00	10B	6.0	10C	17.75	18.44	3.00

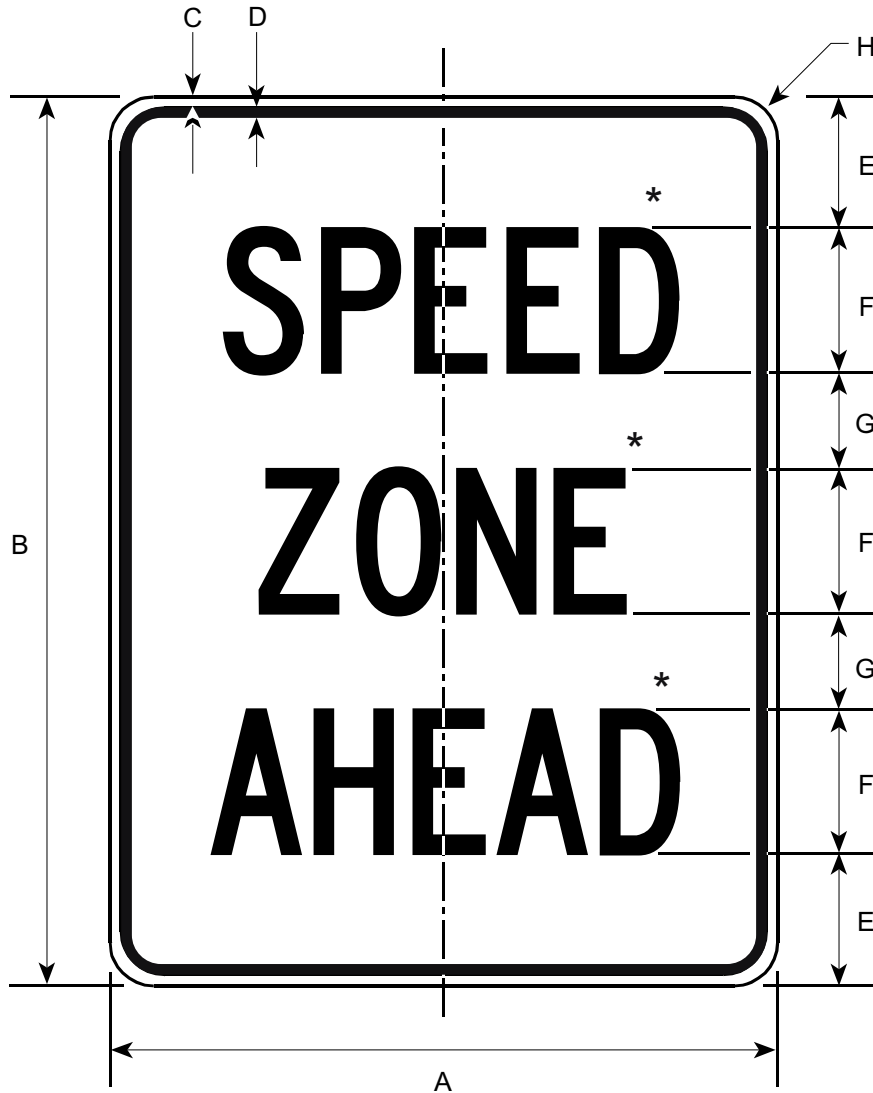

Border and Legend: Black
Background: White

* Reduce letter spacing 40% for Conventional size

Road Class	Dimensions (inches)							
	A	B	C	D	E	F	G	H
Minimum	24	30	0.38	0.63	3.5	6C	2.5	1.5
Conventional	30	36	0.50	0.75	4.0	7C	3.0	2.0
Expressway	36	48	0.63	0.88	7.0	8C	5.0	2.25
Freeway	48	60	0.75	1.25	9.0	10C	6.0	3.0

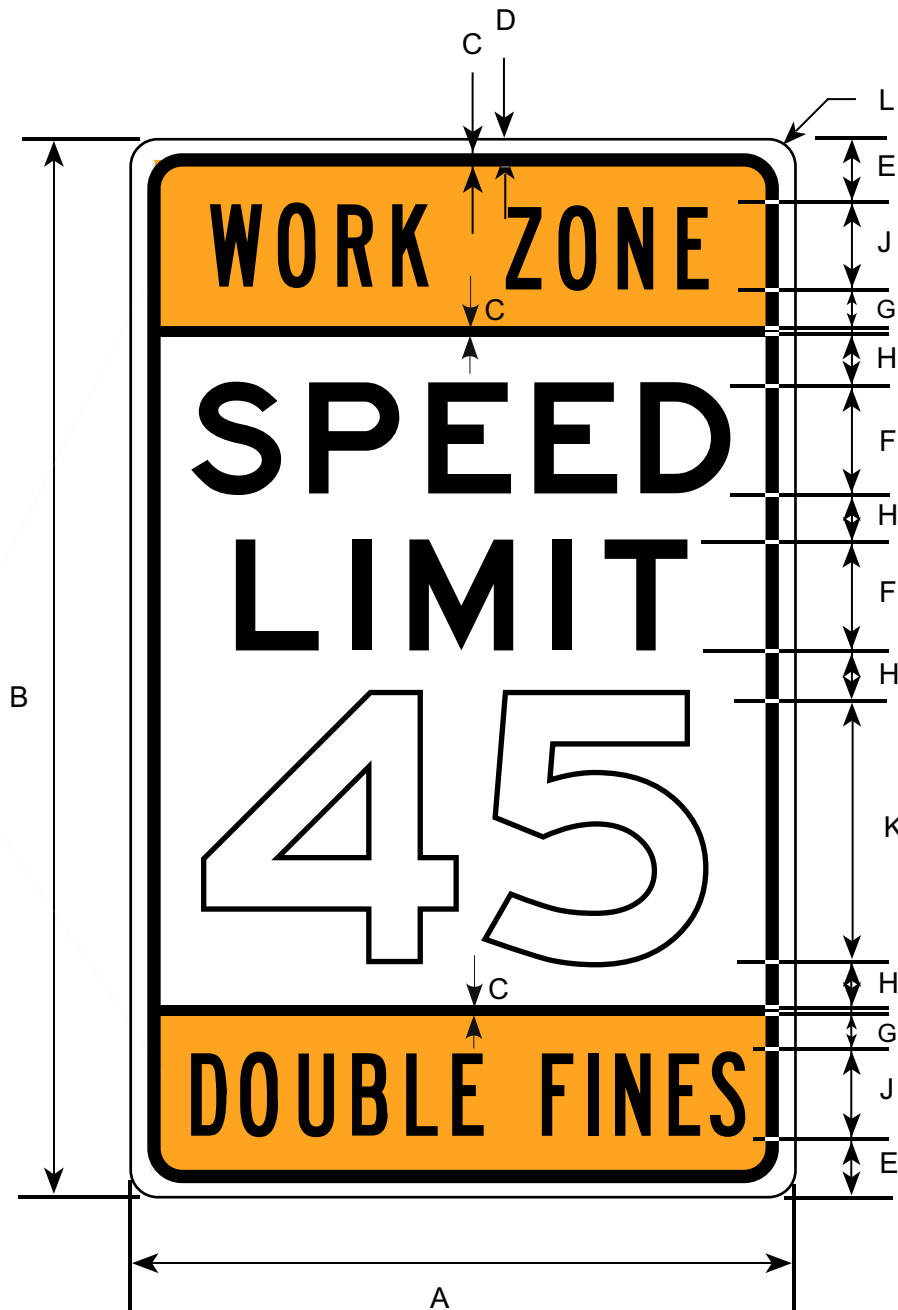

Border and Legend: Black
 Middle Background: White
 Upper & Lower Background: Orange

Prior to the 2002 publication of this manual, this sign was numbered AK-CR2-100.

Road Class	Dimensions (inches)										
	A	B	C	D	E	F	G	H	J	K	L
Conv & Min	30	48	0.88	0.63	2.50	5E	1.12	2.25	4B	12E	2.25

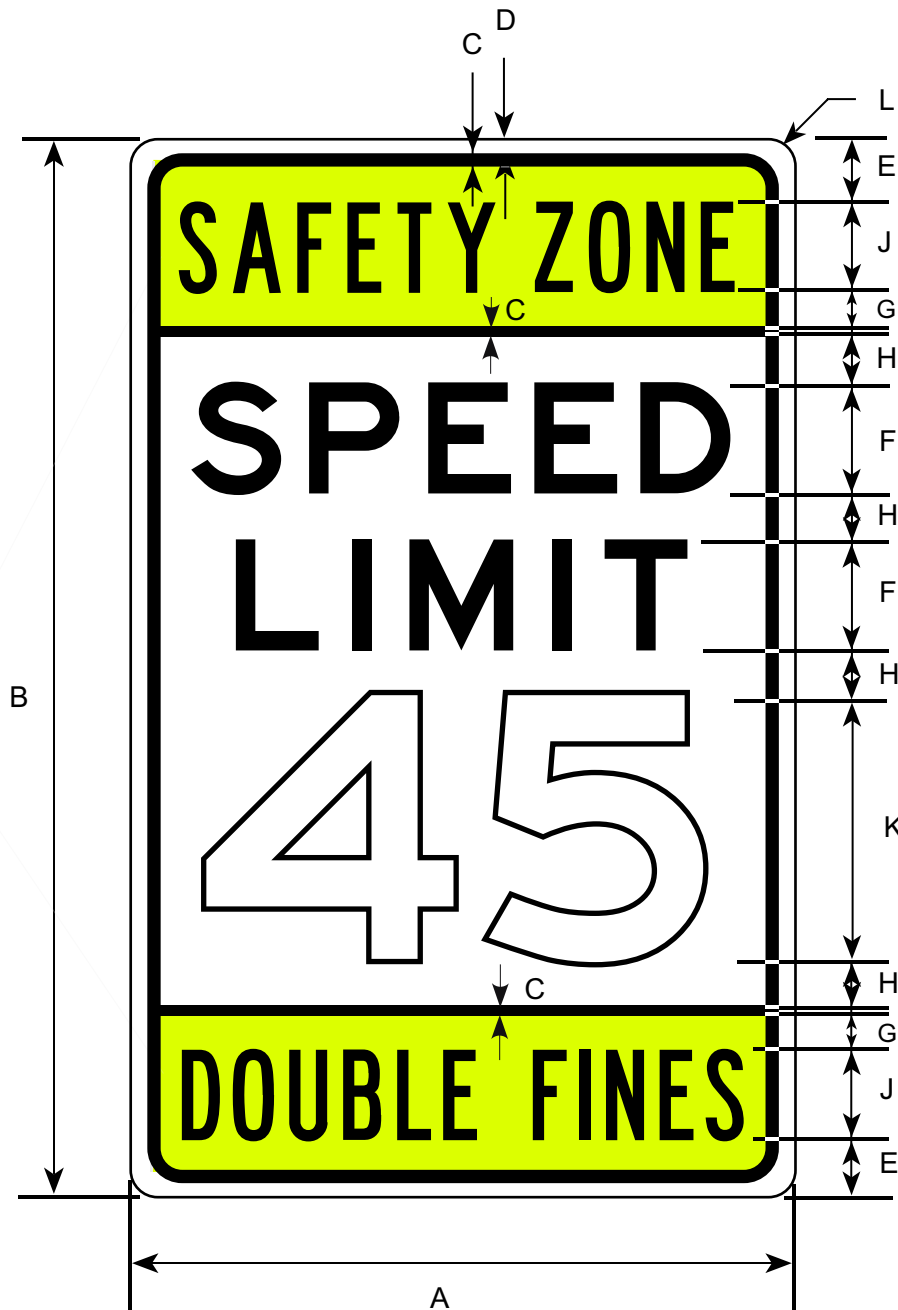

Border and Legend: Black
 Middle Background: White
 Upper & Lower Background: Fluorescent Yellow

Road Class	Dimensions (inches)										
	A	B	C	D	E	F	G	H	J	K	L
Conv & Min	30	48	0.88	0.63	2.50	5E	1.12	2.25	4B	12E	2.25

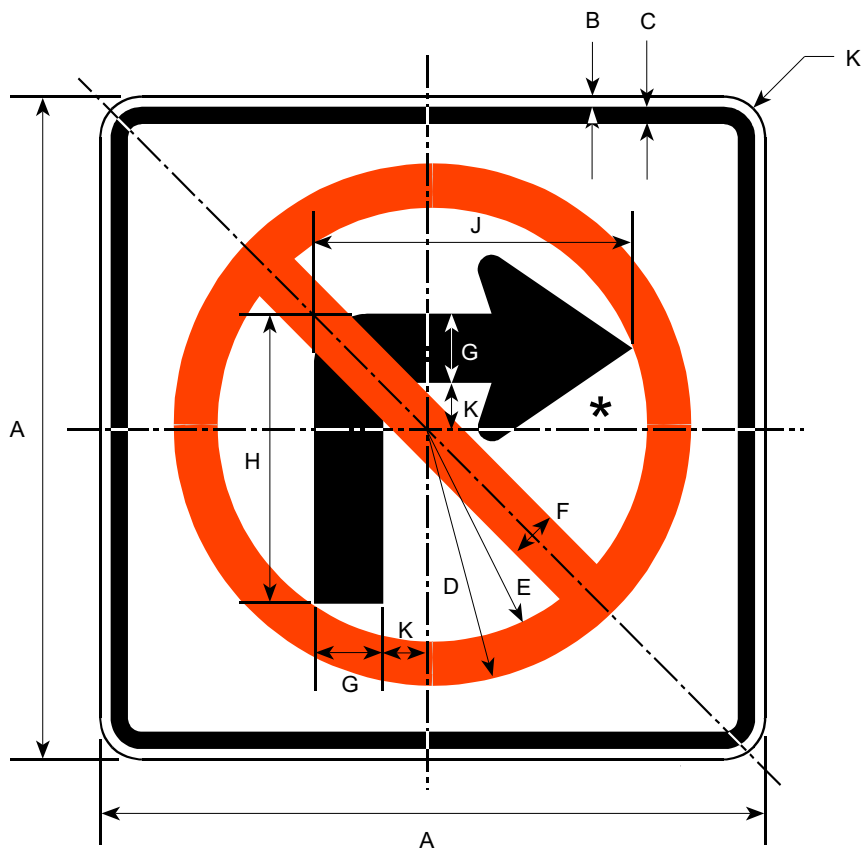

Circle, Diagonal: Red
 Symbol, Border, Legend: Black
 Background: White

*See Appendix B-1 for Standard Arrow Details.

Road Class	Dimensions (inches)									
	A	B	C	D	E	F	G	H	J	K
Minimum	24	0.38	0.63	10.5	8.50	2.0	2.5	10.5	11.5	1.5
Conventional	30	0.50	0.75	13.13	10.63	2.5	3.13	13.13	14.5	1.88
Expressway	36	0.63	0.88	15.75	12.75	3.0	3.75	15.75	17.25	2.25
Oversized	48	0.75	1.25	21	17	4.0	5.0	21	23	3.0

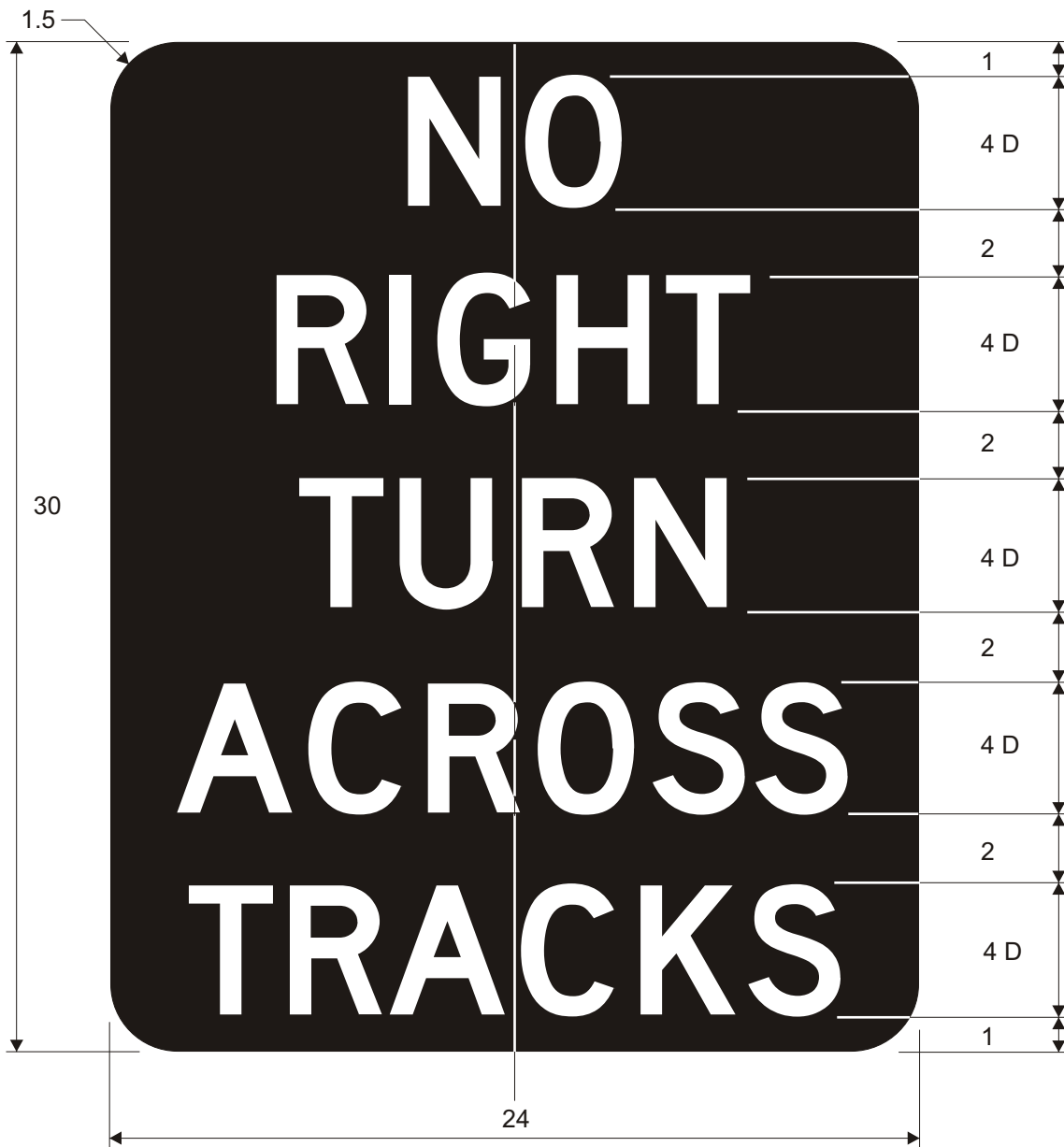

Legend: White
Background: Black

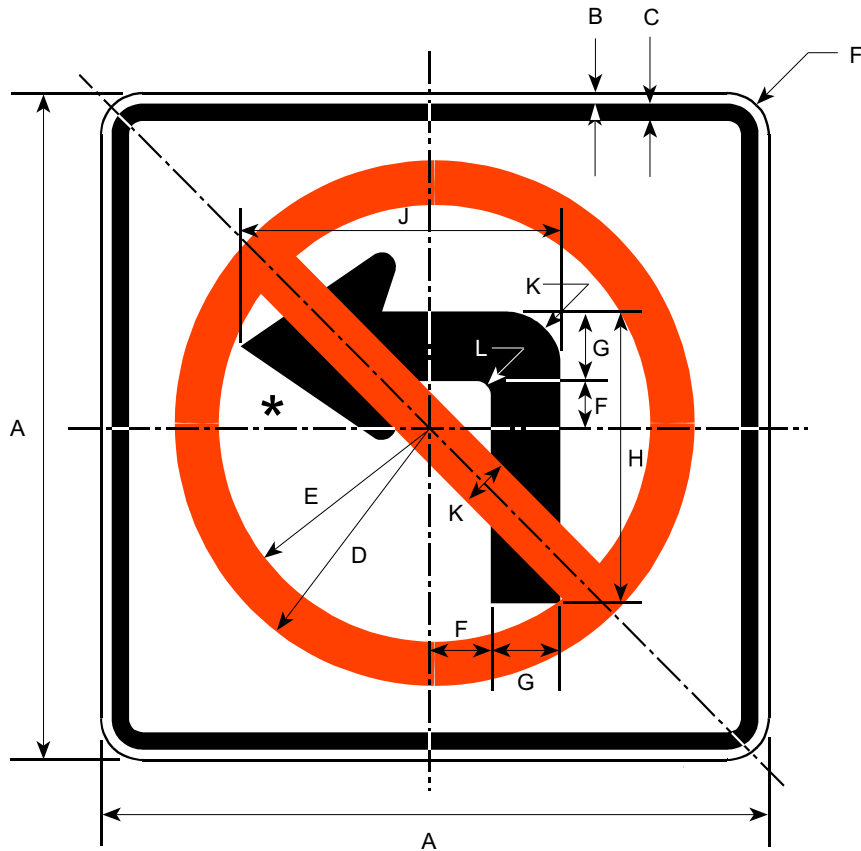

Circle, Diagonal: Red
 Arrow, Border, Legend: Black
 Background: White

*See Appendix B-1 for Standard Arrow Details.

Road Class	Dimensions (inches)										
	A	B	C	D	E	F	G	H	J	K	L
Minimum	24	0.38	0.63	10.5	8.5	1.5	2.5	10.5	11.5	2.0	0.5
Conventional	30	0.50	0.75	13.13	10.63	1.88	3.13	13.13	14.5	2.5	0.63
Expressway	36	0.63	0.88	15.75	12.75	2.25	3.75	15.75	17.25	3.0	0.75
Oversized	48	0.75	1.25	21	17	3.0	5.0	21	23	4.0	1.0

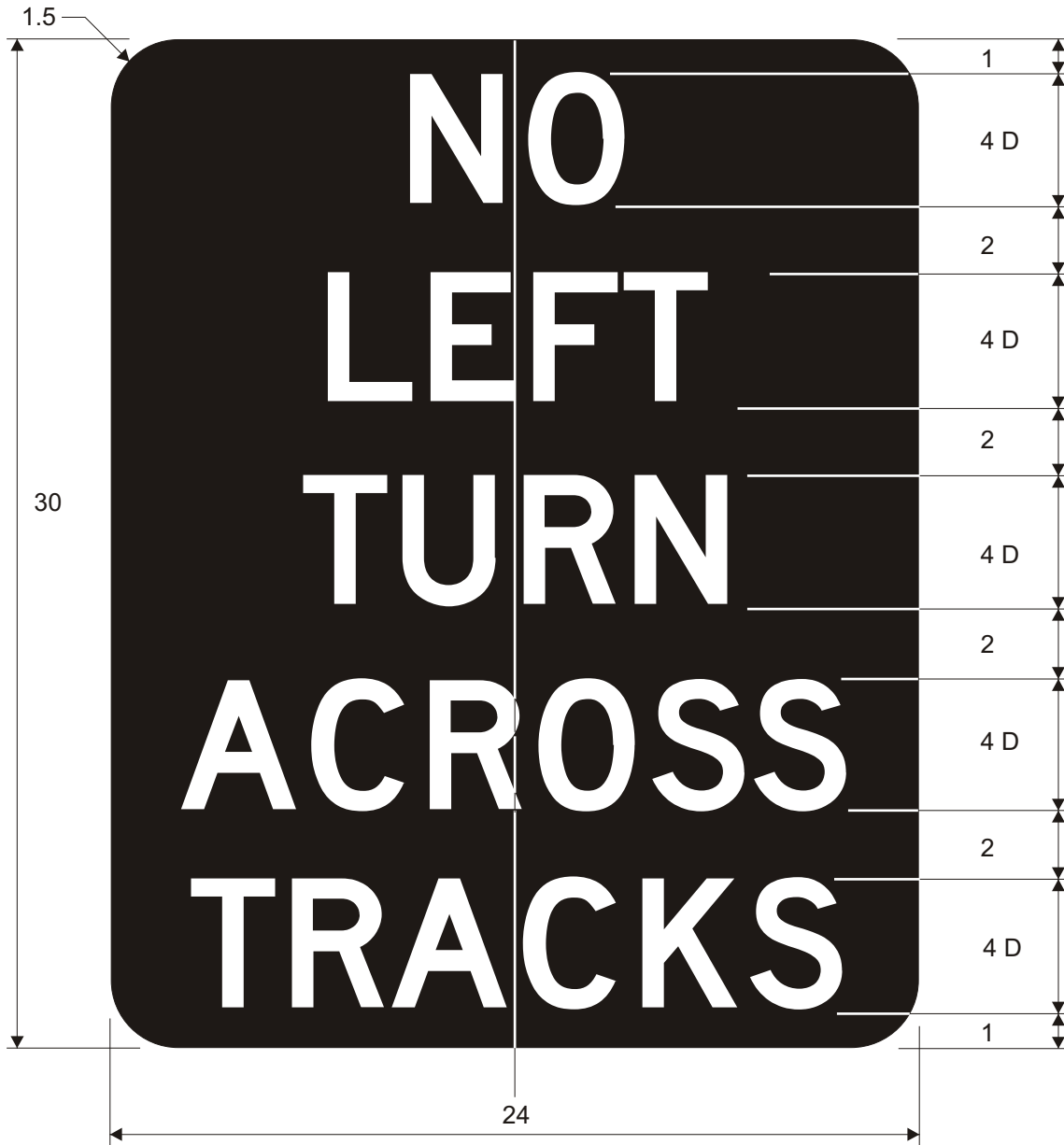

Legend: White
Background: Black

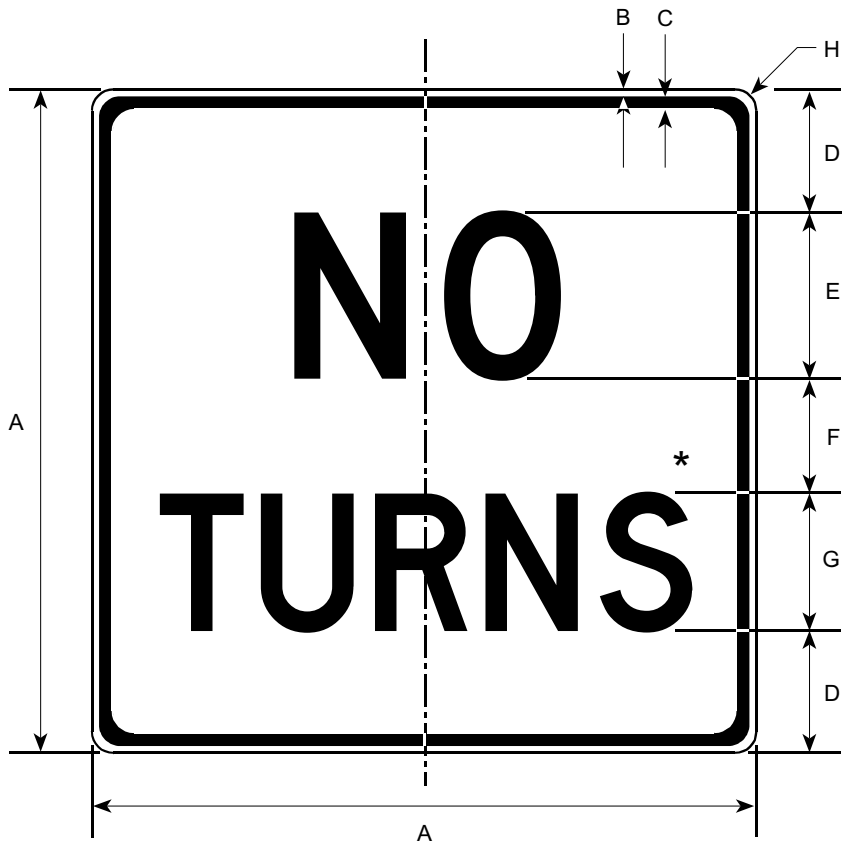

Border and Legend: Black
 Background: White

* Reduce letter spacing 35%.

Road Class	Dimensions (inches)							
	A	B	C	D	E	F	G	H
Minimum	24	0.38	0.63	4.5	6D	4.0	5D	1.5
Conventional	30	0.50	0.75	5.5	8D	5.0	6D	1.88
Expressway	36	0.63	0.88	6.0	10D	6.0	8D	2.25
Oversized	48	0.75	1.25	9.0	12D	8.0	10D	3.0

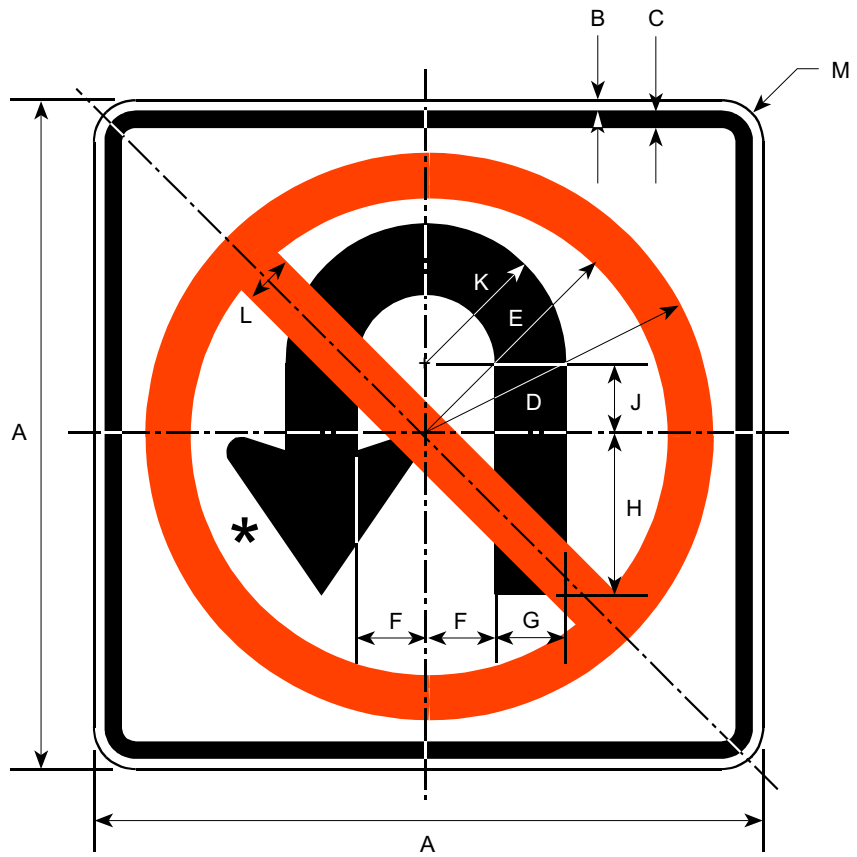

Circle, Diagonal: Red
 Arrow, Border, Legend: Black
 Background: White

*See Appendix B-1 for Standard Arrow Details.

Road Class	Dimensions (inches)											
	A	B	C	D	E	F	G	H	J	K	L	M
Minimum	24	0.38	0.63	10.5	8.5	2.5	2.5	6.0	2.25	5.0	2.0	1.5
Conventional	30	0.50	0.75	13.13	10.63	3.13	3.13	7.5	2.81	6.25	2.5	1.88
Expressway	36	0.63	0.88	15.75	12.75	3.75	3.75	9.0	3.38	7.5	3.0	2.25
Oversized	48	0.75	1.25	21	17	5.0	5.0	12	4.5	10	4.0	3.0

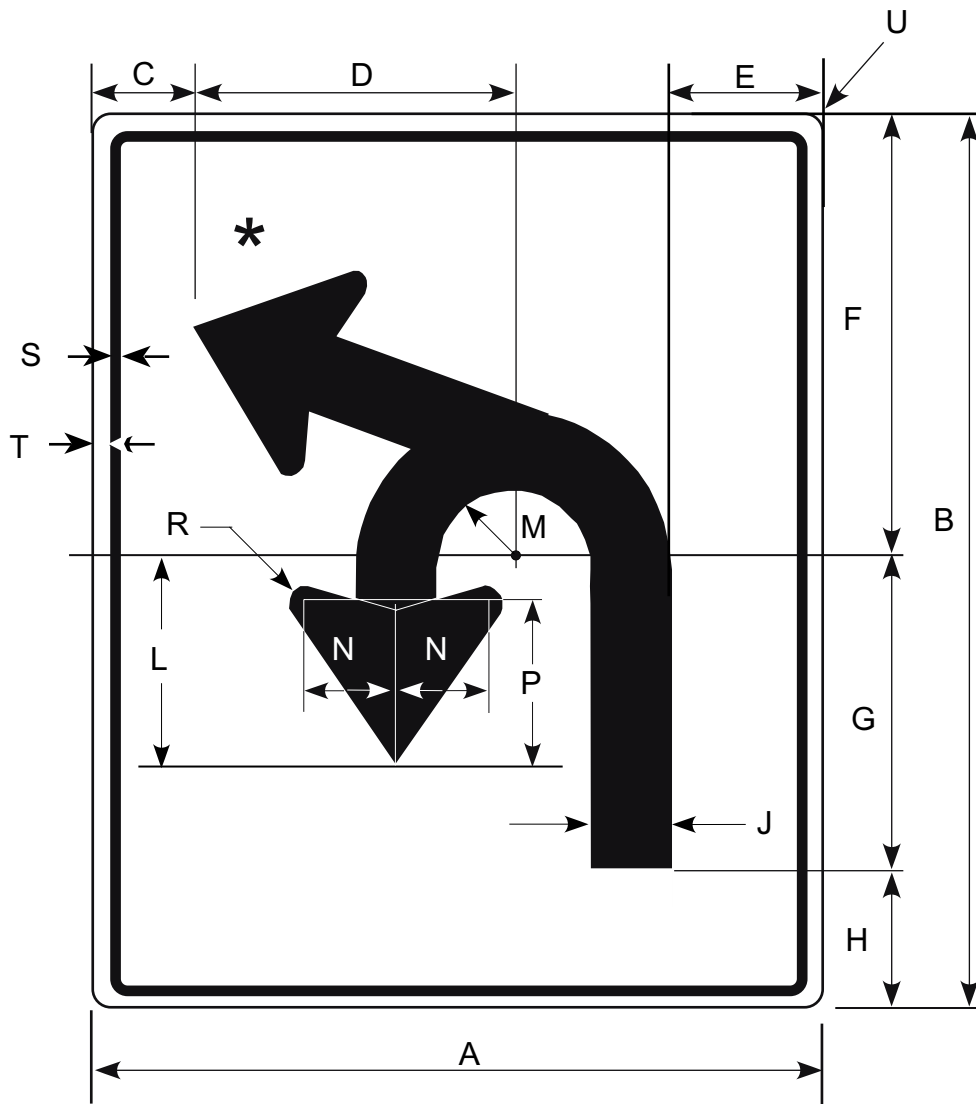

Border and Legend: Black
Background: White

*See Appendix B-1 for Standard Arrow Details.

Road Class	Dimensions (inches)									
	A	B	C	D	E	F	G	H	J	L
Std & Conv	30	36	4.0	13	6.25	18	12.5	5.5	3.75	8.0
	M	N	P	R	S	T	U			
	4	3.63	6.38	0.63	1.88	0.50	0.75			

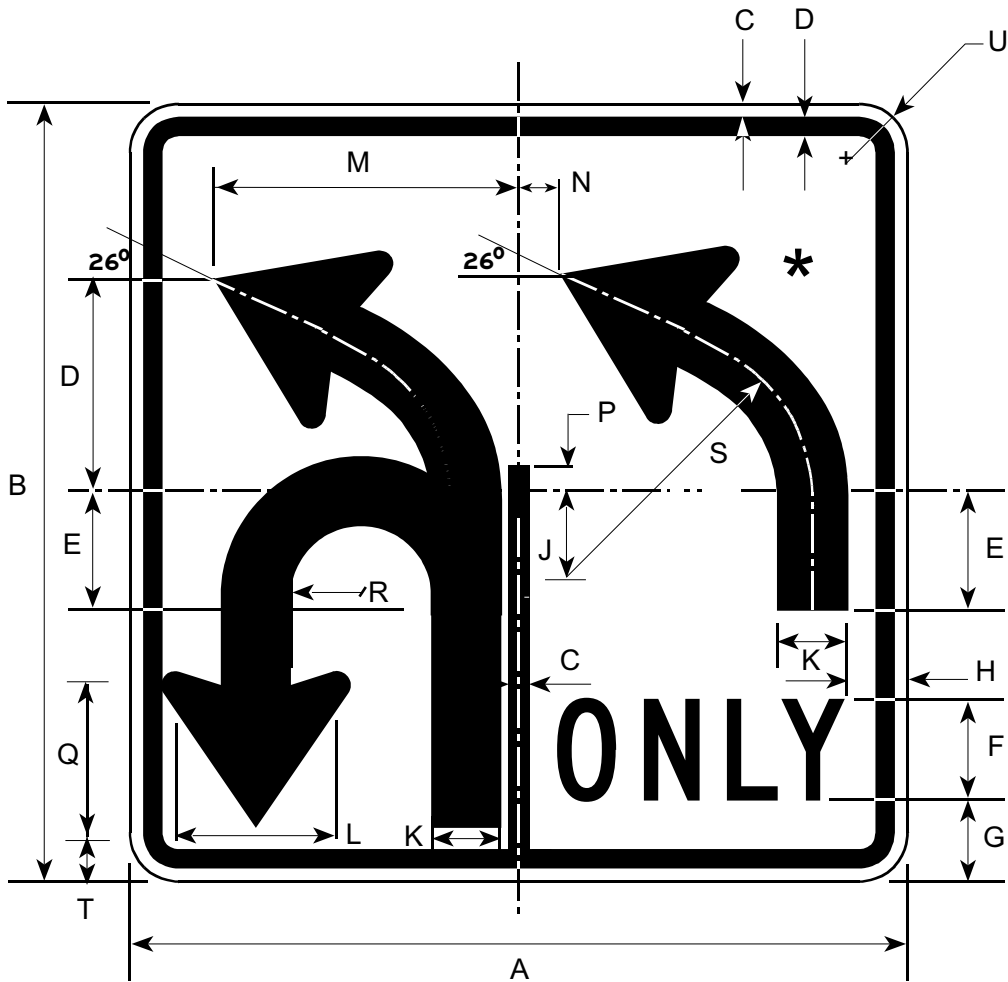

Border and Legend: Black
Background: White

*See Appendix B-1 for Standard Arrow Details.

Road Class	Dimensions (inches)										
	A	B	C	D	E	F	G	H	J	K	L
Conventional	48	36	0.8	1.3	6.4	6D	3.6	3.2	2.88	3.13	7.25
	M	N	P	Q	R	S	T	U			
	19	4.0	2.0	6.38	3.6	12	2.81	2.5			

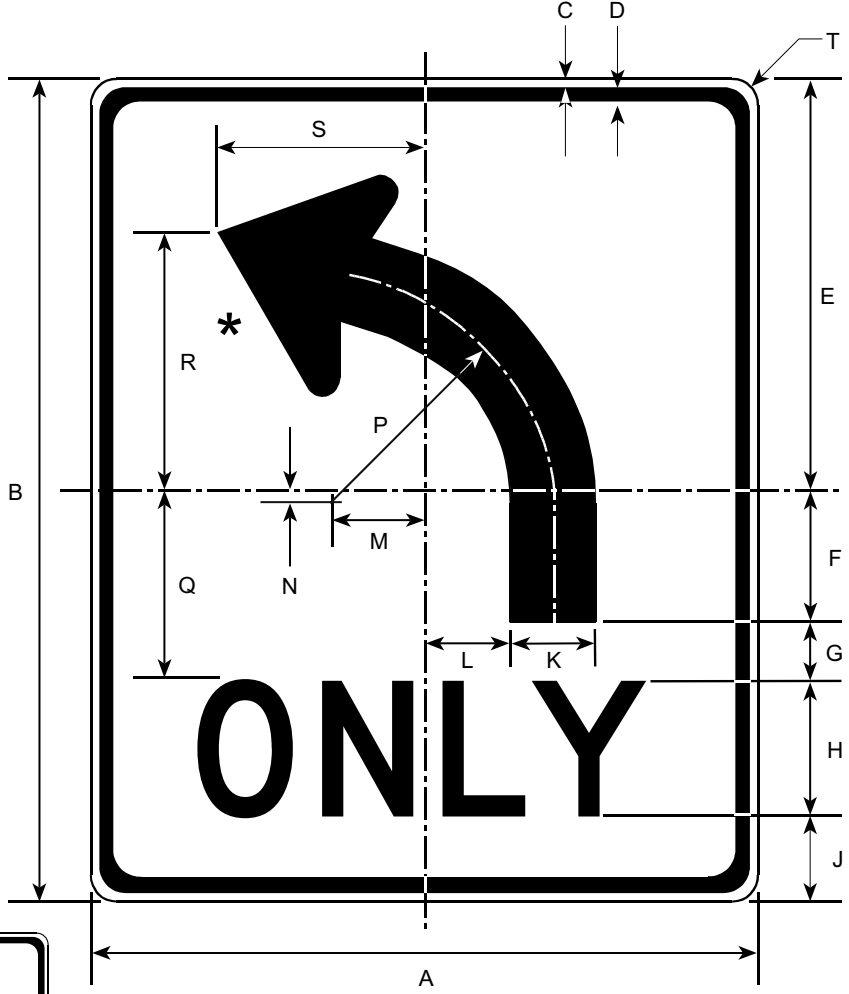

R3-5L

Border and Legend: Black
Background: White

*See Appendix B-1 for Standard Arrow Details.



R3-5R

Road Class	Dimensions (inches)										
	A	B	C	D	E	F	G	H	J	K	L
Minimum (Ground Mount Only)	24	30	0.38	0.63	15	4.75	2.0	5D	3.25	3.25	3.3
Conventional	30	36	0.50	0.75	18	5.75	2.5	6D	3.75	3.75	3.88
	M	N	P	Q	R	S	T				
	3.25	0.4	7.88	6.85	9.35	7.5	1.5				
	3.75	0.5	9.5	8.25	11.25	9.25	1.88				

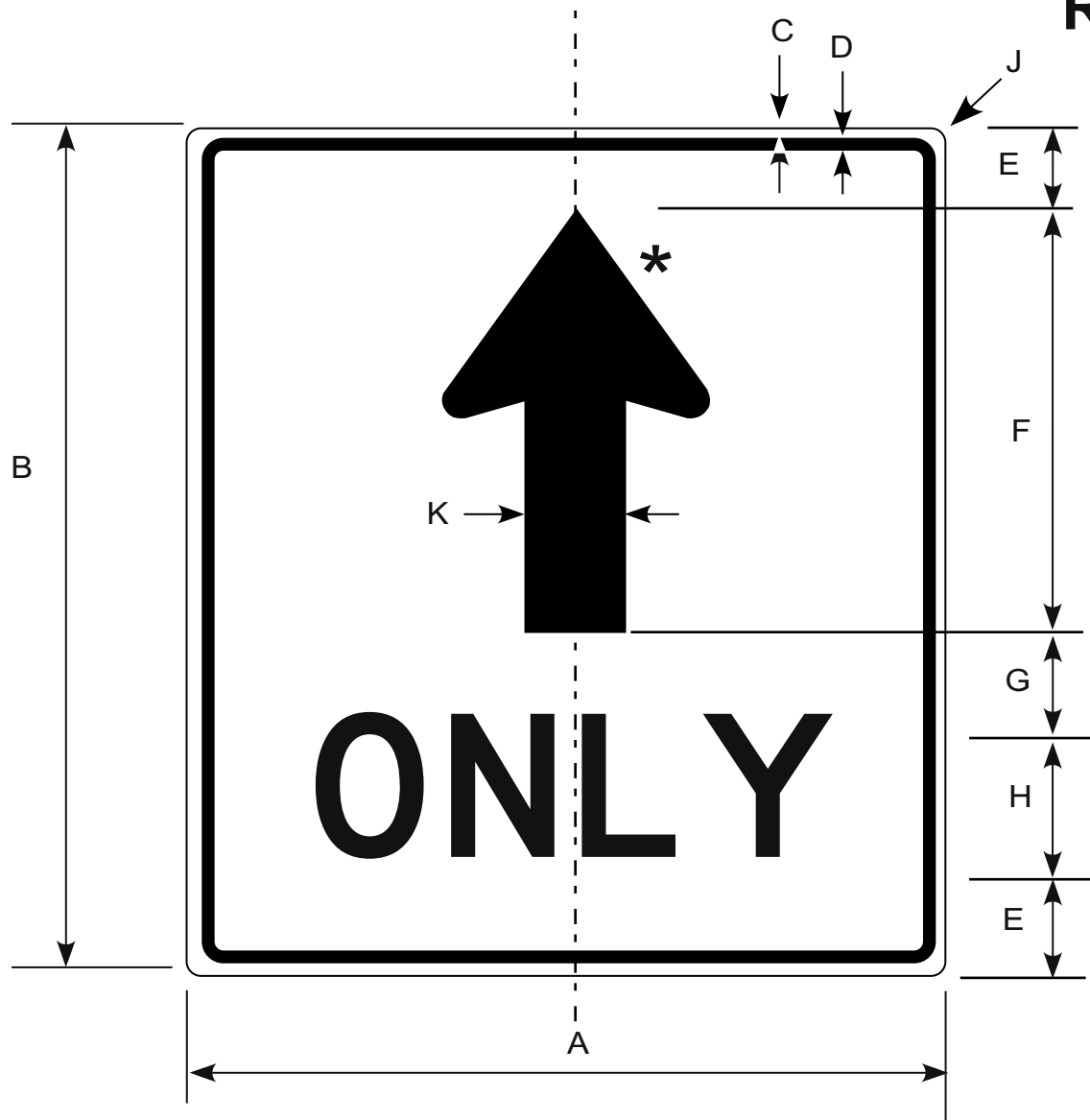

Border, Symbol, and Legend: Black
Background: White

*See Appendix B-1 for Standard Arrow Details.

Dimensions (inches)										
A	B	C	D	E	F	G	H	J	K	
30	36	0.50	0.75	3.75	18	4.50	6D	1.88	3.75	

R3-5B
 R3-5C
 R3-5D
 R3-5E
 R3-5F
 R3-5G

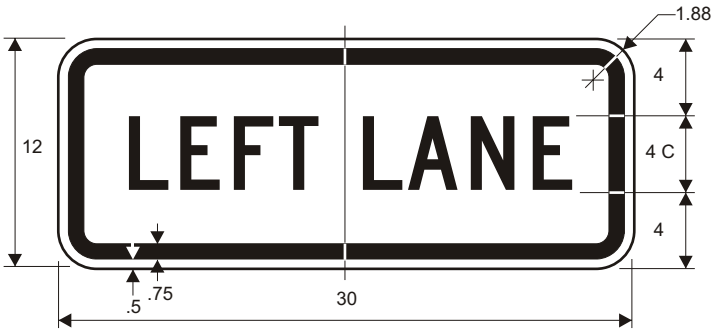

R3-5B

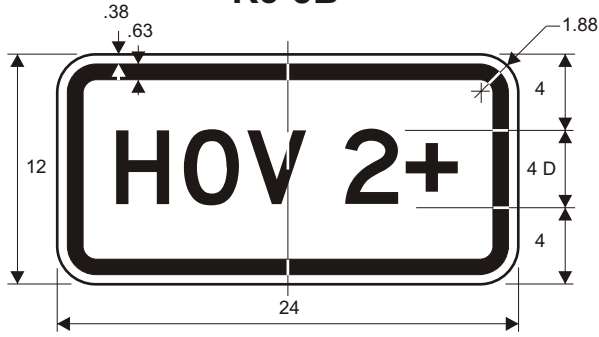

R3-5C

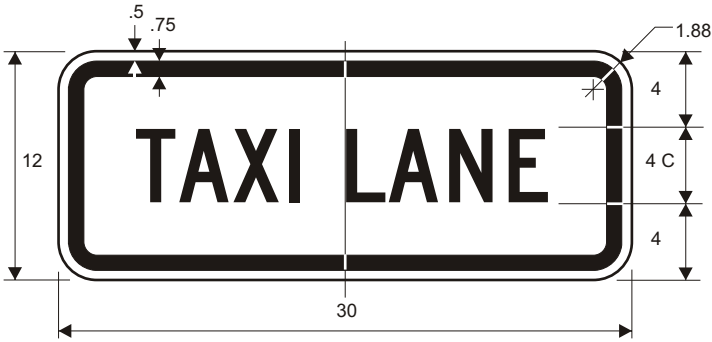

R3-5D

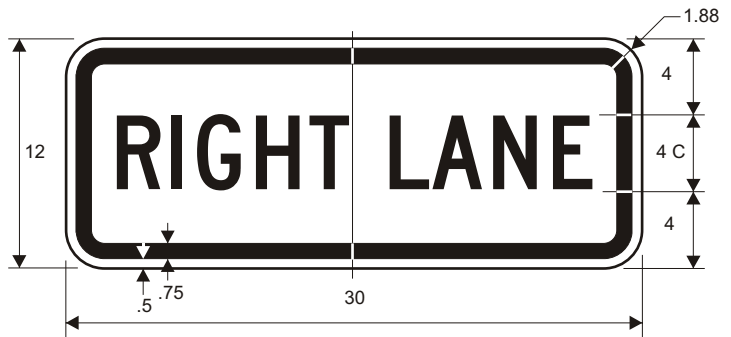

R3-5F

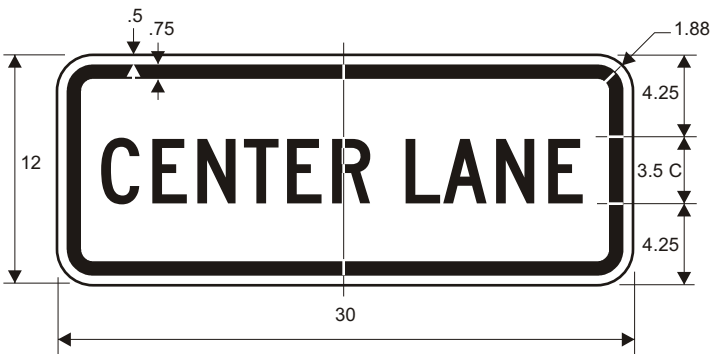

R3-5E

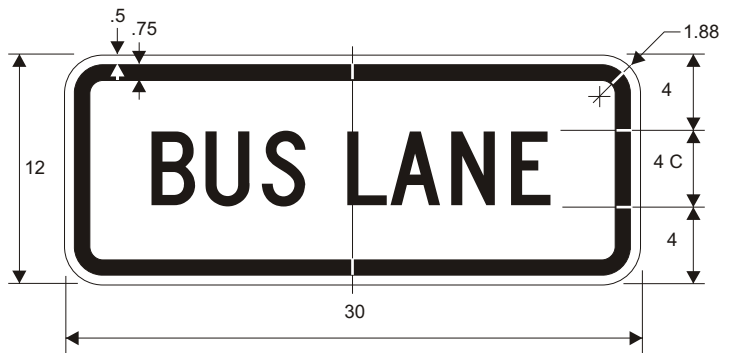

R3-5G

Legend: Black
 Background: White

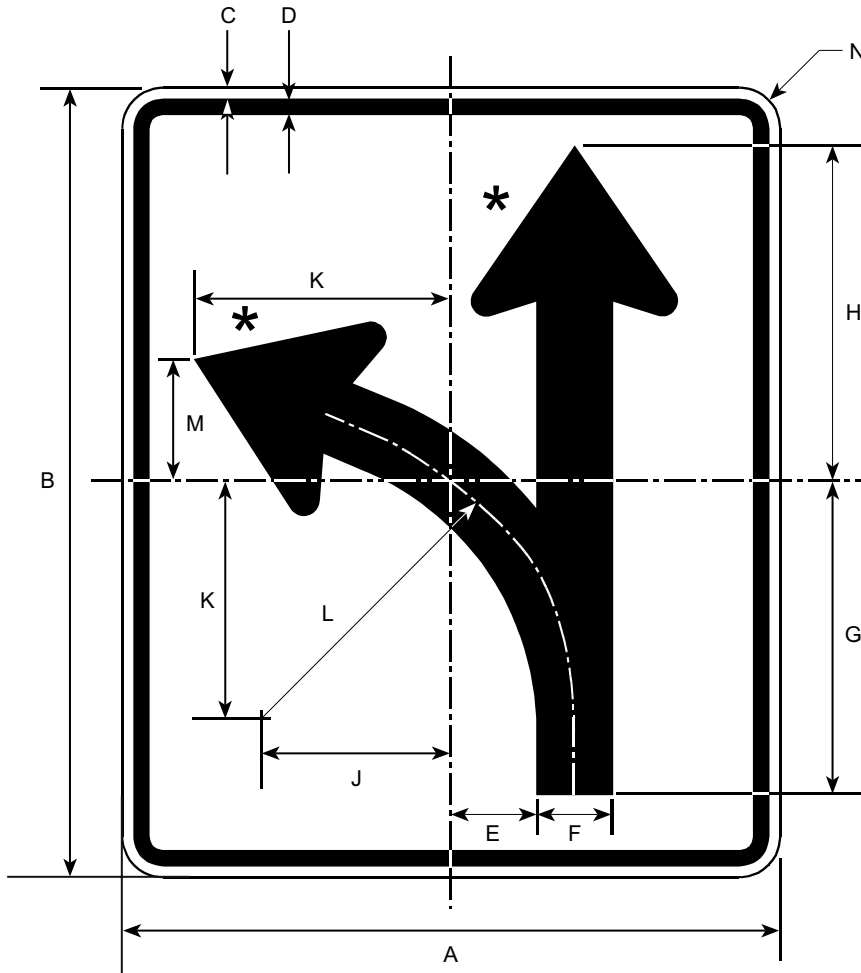

Border and Legend: Black
 Background: White

*See Appendix B-1 for Standard Arrow Details.

Prior to the 2002 publication of this manual, this sign was numbered R3-6SL.

Road Class	Dimensions (inches)												
	A	B	C	D	E	F	G	H	J	K	L	M	N
Conv & Min	30	36	0.50	0.75	3.88	3.50	14.25	15.38	8.88	11.75	14.50	5.63	1.88

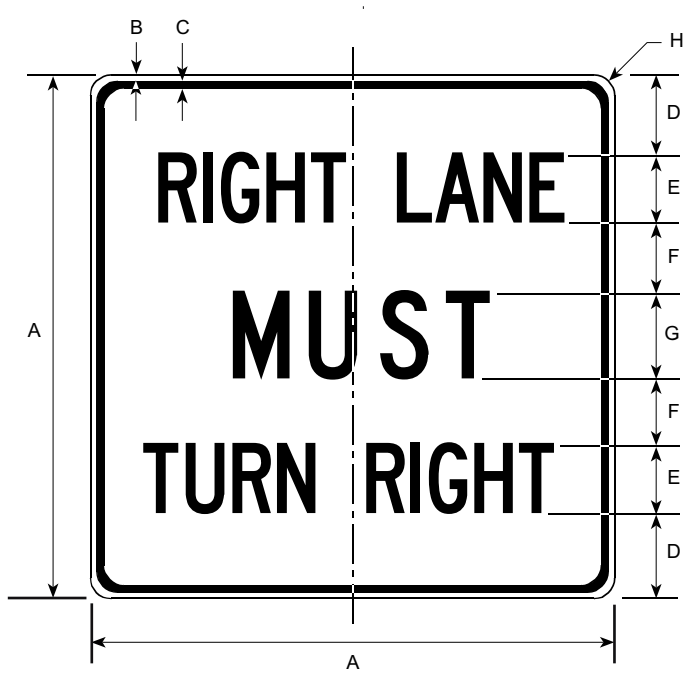

R3-7R



R3-7L

Border and Legend: Black
Background: White







Road Class	Dimensions (inches)							
	A	B	C	D	E	F	G	H
Minimum	30	0.50	0.75	4.5	4C	4.0	5C	1.88
Conventional	36	0.63	0.88	5.5	5C	4.5	6C	2.25
Expressway	48	0.75	1.25	8.0	6C	6.0	8C	3.0

R3-8 Options

Multiple lane use control signs (R3-8s) may be specified with legends other than those illustrated on the following pages.

All R3-8 signs shall have black legends on white backgrounds.

Movements may be signified with the following suffixes:

Movement:	 ONLY	 ONLY	 ONLY			
Suffix:	L	S	R	SL	SR	LR

For example, a sign indicating a restricted left turn lane, a left or through center lane, and a restricted right turn lane would appear as follows:

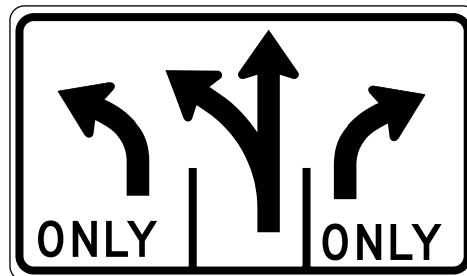

R3-8L/SL/R

R3-8 L/LR

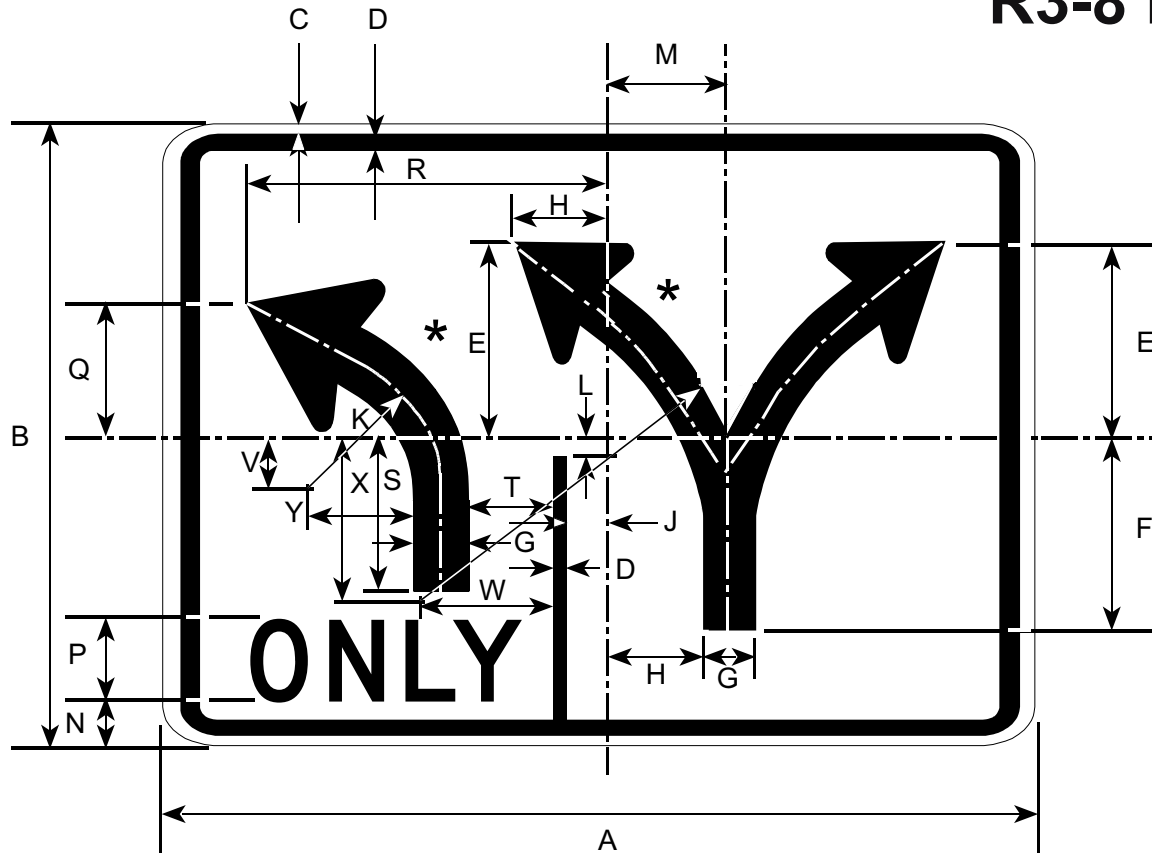

Border and Legend: Black
Background: White

*See Appendix B-1 for Standard Arrow Details.

Prior to 2002 publication of this manual, this sign was numbered R3-8L/DT.

Road Class	Dimensions (inches)												
	A	B	C	D	E	F	G	H	J	K	L	M	N
Conv&Min	36	30	0.5	0.75	8.0	10.25	2.5	4.0	1.75	5.75	1.0	5.25	3.0
	P	Q	R	S	T	V	W	X	Y	Z			
	4D	5.0	15	6.5	3.25	2.63	5.25	7.5	4.5	14.5			

R3-8 L/S

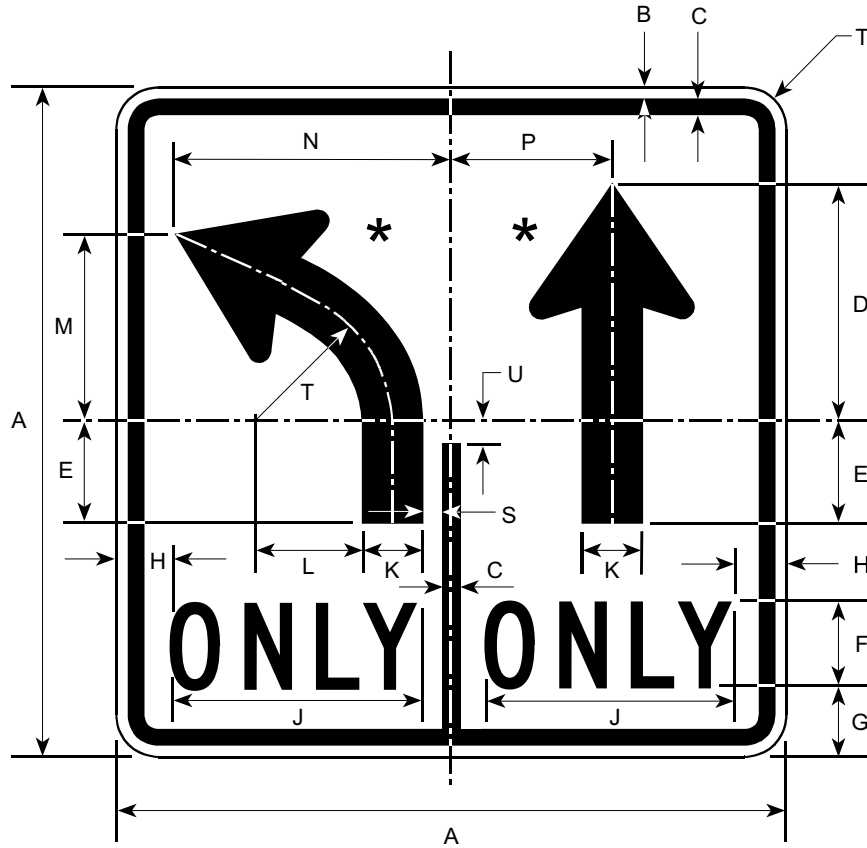

Border and Legend: Black
Background: White

*See Appendix B-1 for Standard Arrow Details.

Road Class	Dimensions (inches)																
	A	B	C	D	E	F	G	H	J	K	L	M	N	P	S	T	U
Conv&Min	30	0.5	0.75	9.06	3.94	4C	3.0	2.56	11.13	2.50	4.50	8.0	11.94	6.88	1.56	1.88	1.0

R3-8 L/SL

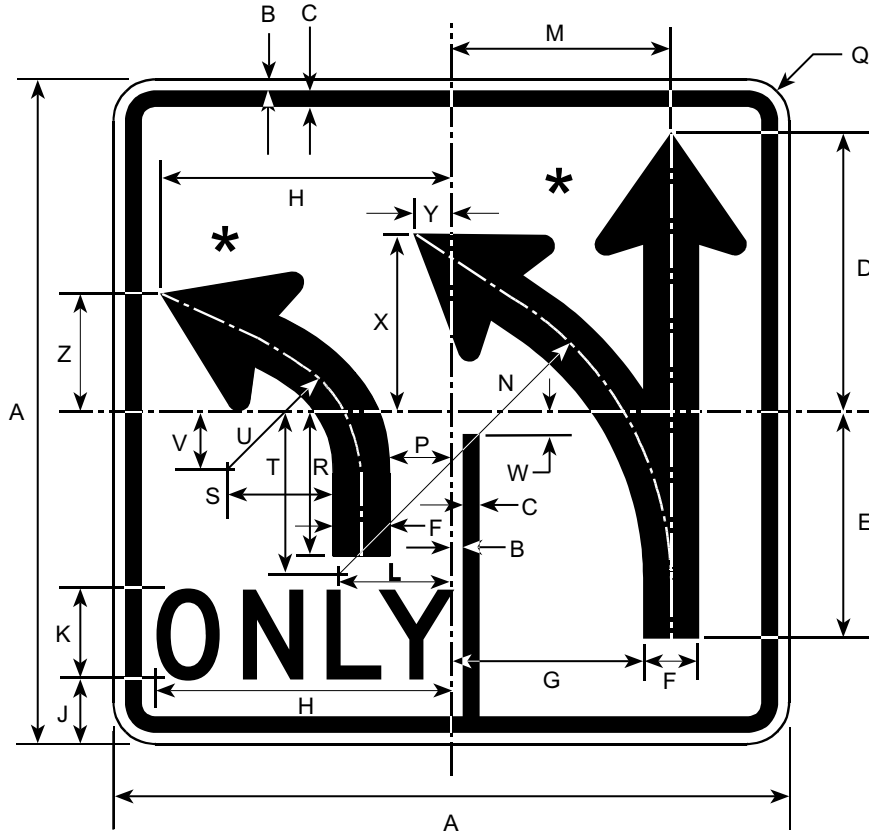

Border and Legend: Black
Background: White

*See Appendix B-1 for Standard Arrow Details.

Road Class	Dimensions (inches)																	
	A	B	C	D	E	F	G	H	J	K	L	M	N	P	Q	R	S	T
Conv&Mn	30	0.50	0.75	12.6	10.25	2.5	8.50	12.88	3.0	4D	4.75	9.75	14.5	2.75	1.9	6.50	4.50	7.5
Expwy	48	0.75	1.25	20.0	16.38	4.0	13.6	20.63	5.0	6D	7.63	15.63	23.3	4.38	3.0	10.38	7.19	12.0

U	V	W	X	Y	Z
5.75	2.63	1.00	8.00	1.75	5.0
9.25	4.25	1.63	12.75	2.75	8.0

R3-9A

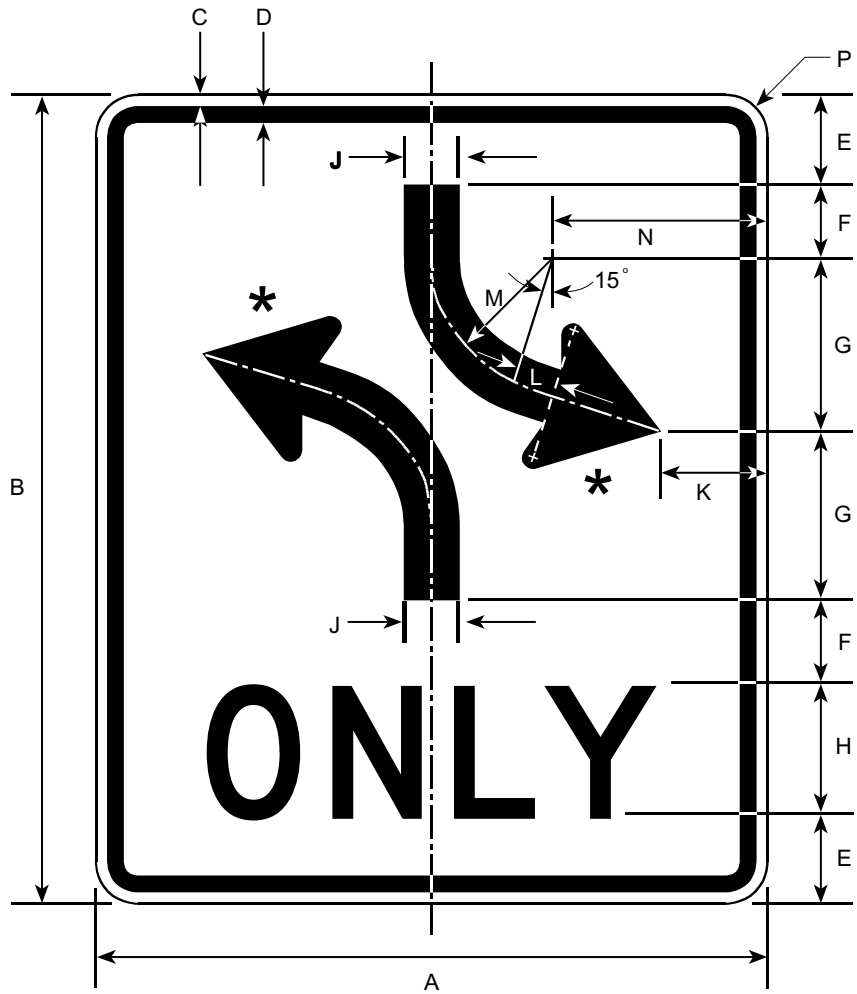

Border and Legend: Black
Background: White

*See Appendix B-1 for Standard Arrow Details.

Road Class	Dimensions (inches)														
	A	B	C	D	E	F	G	H	J	K	L	M	N	P	
Conv & Min	30	36	0.50	0.75	4.0	3.0	8.0	6D	2.5	4.0	1.5	6.0	9.0	1.88	
Expressway	48	60	1.25	0.75	7.0	5.0	13	10D	4.0	6.5	2.38	9.5	14.5	3.0	

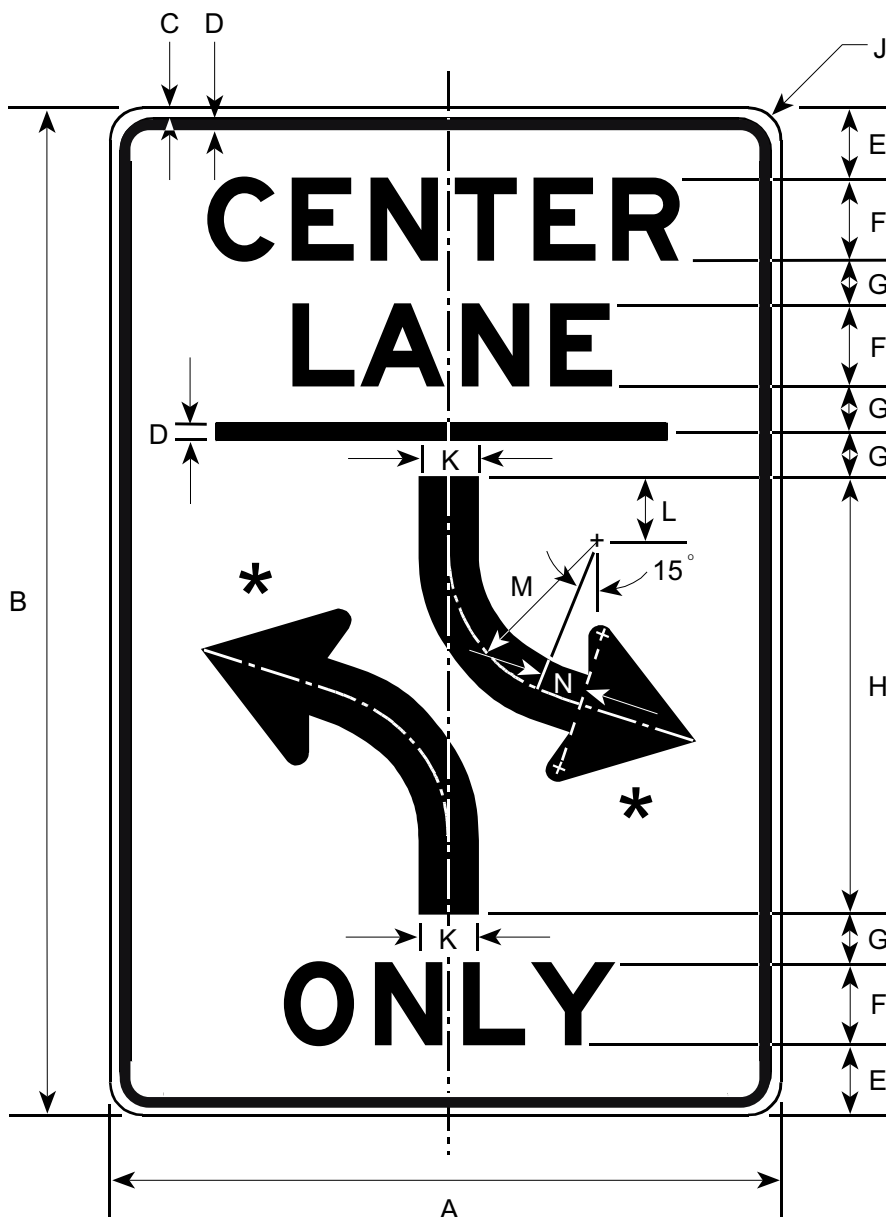

Border and Legend: Black
Background: White

*See Appendix B-1 for Standard Arrow Details.

Road Class	Dimensions (inches)												
	A	B	C	D	E	F	G	H	J	K	L	M	N
Conv & Min	24	36	0.38	0.63	2.5	3E	1.5	16	1.50	2.0	2.5	6.0	1.5
Expressway	36	48	0.63	0.88	3.5	5E	1.5	20	2.25	3.0	3.0	8.0	2.0

R3-9D

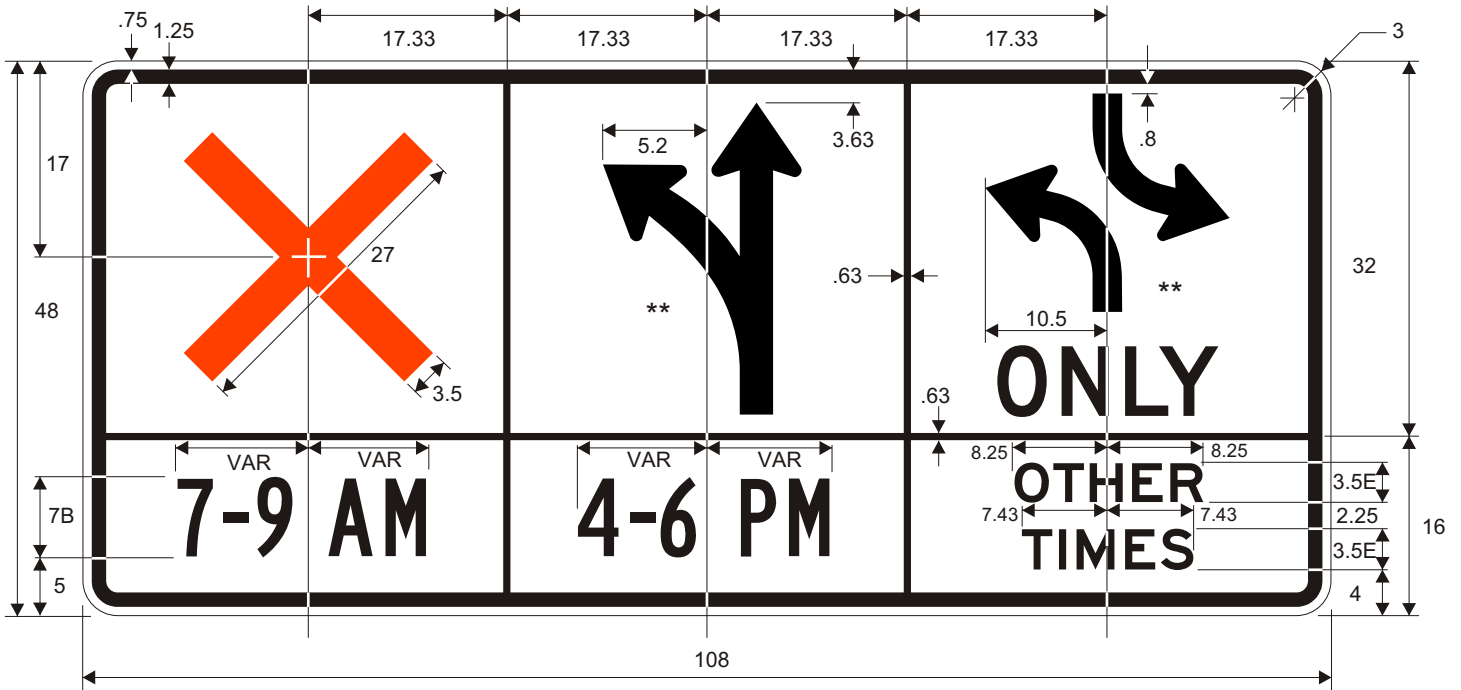

*Insert R3-8a, increase 17% to fit.
 **Insert R3-9a.

Border and Legend: Black
 Symbols: Black
 Exclusion: Red
 Background: White

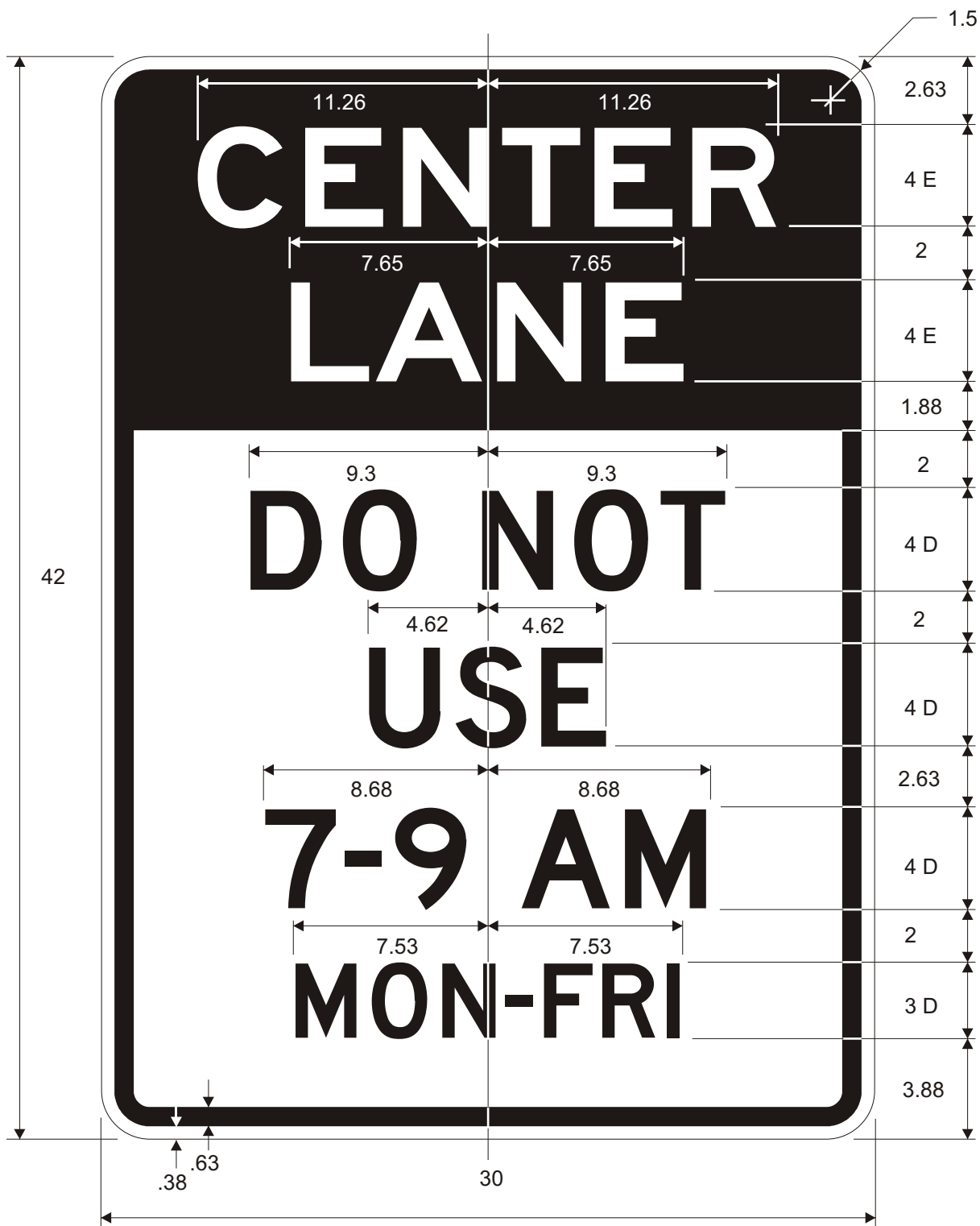

Top:
 Legend: White
 Background: Black

Bottom:
 Border and Legend: Black
 Background: White

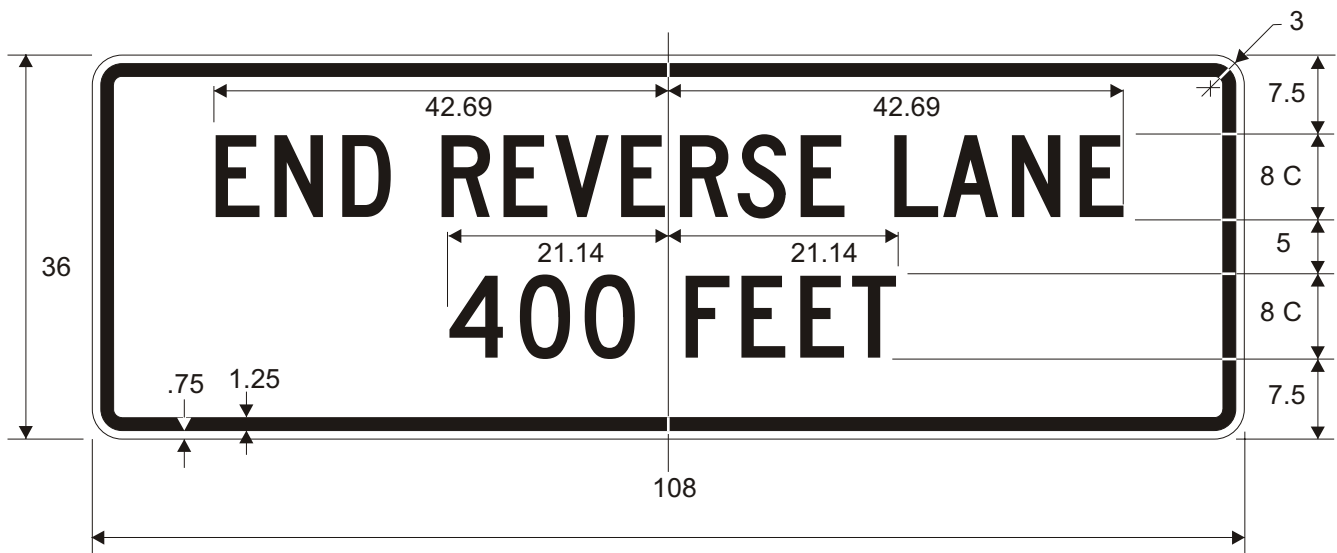
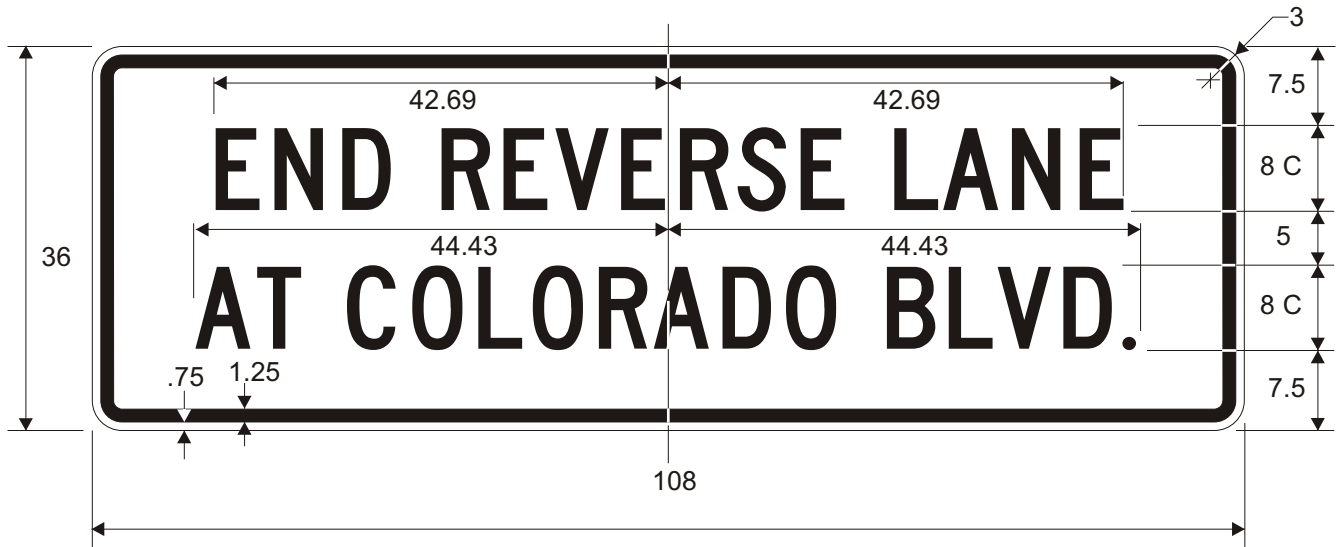

Border and Legend: Black
Background: White

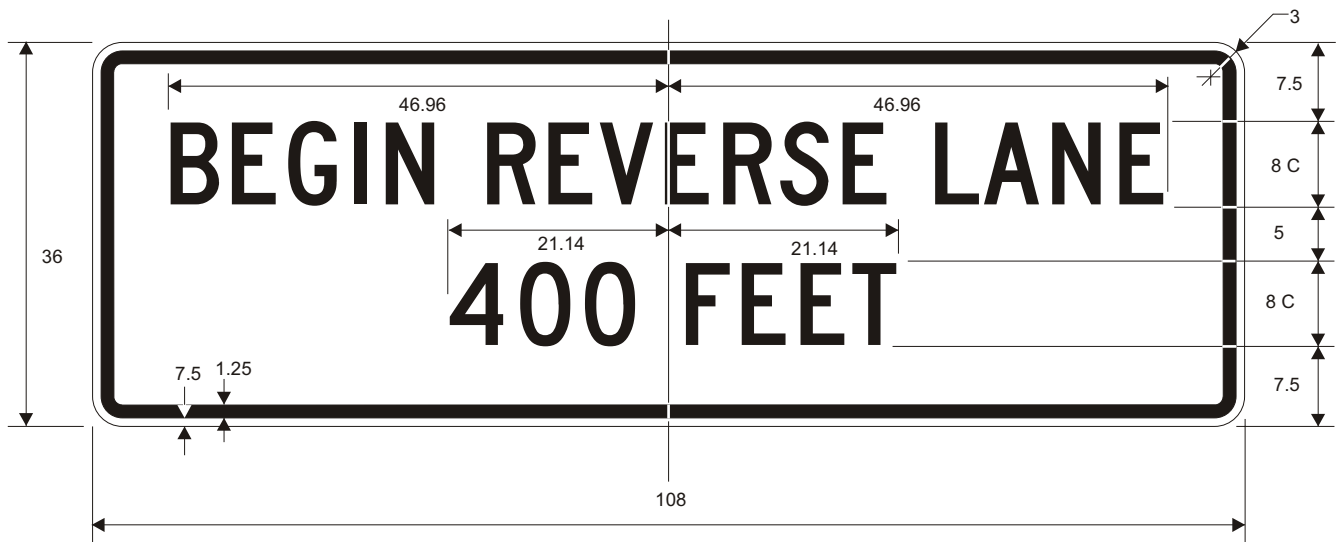
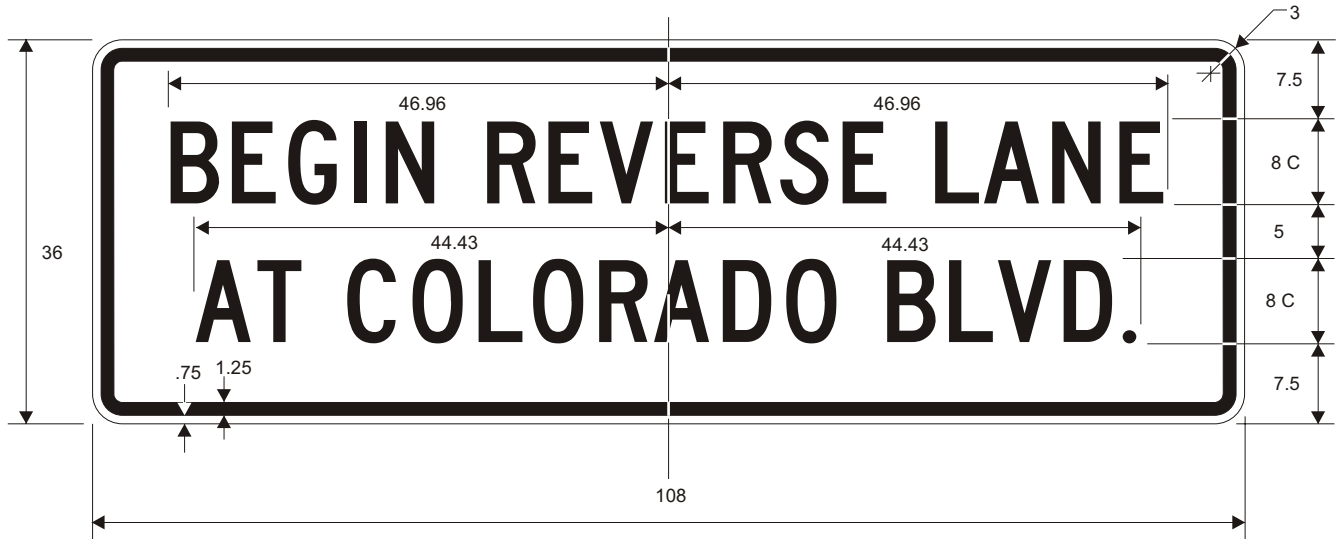

Border and Legend: Black
Background: White

R3-9I

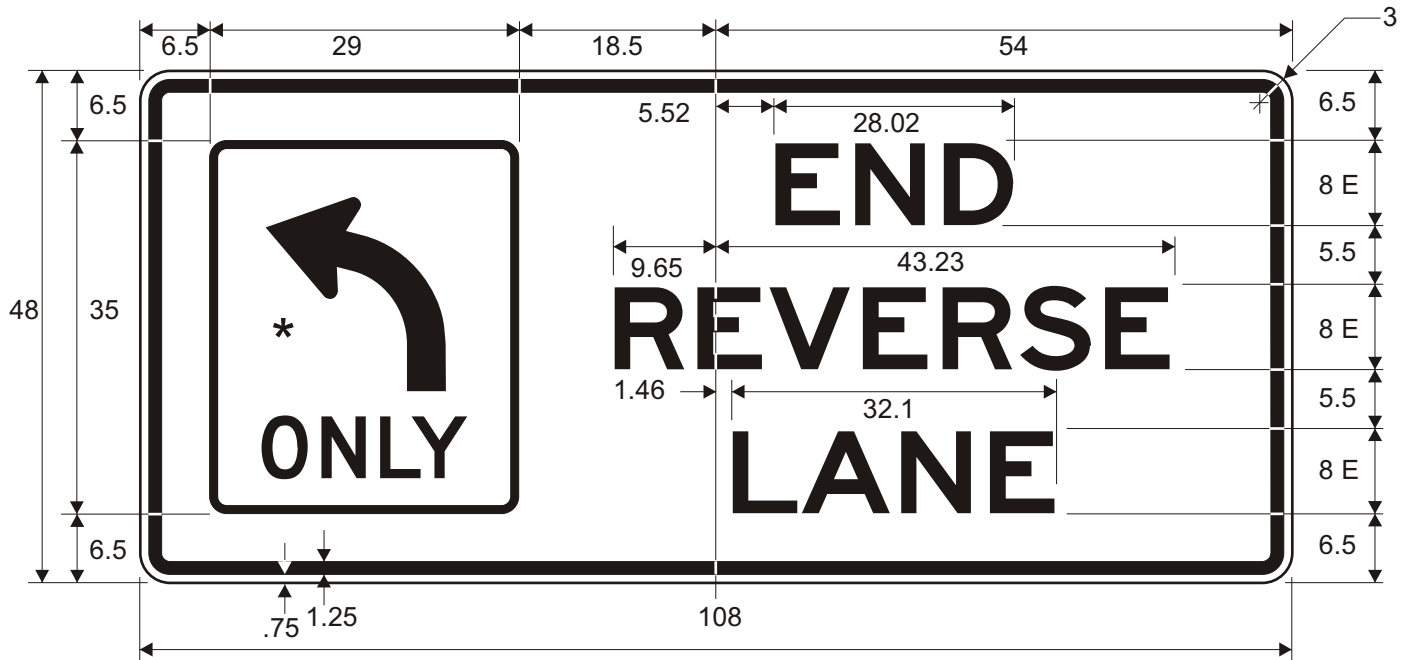

*Insert R3-5.

Border and Legend: Black
Background: White

R3-10A

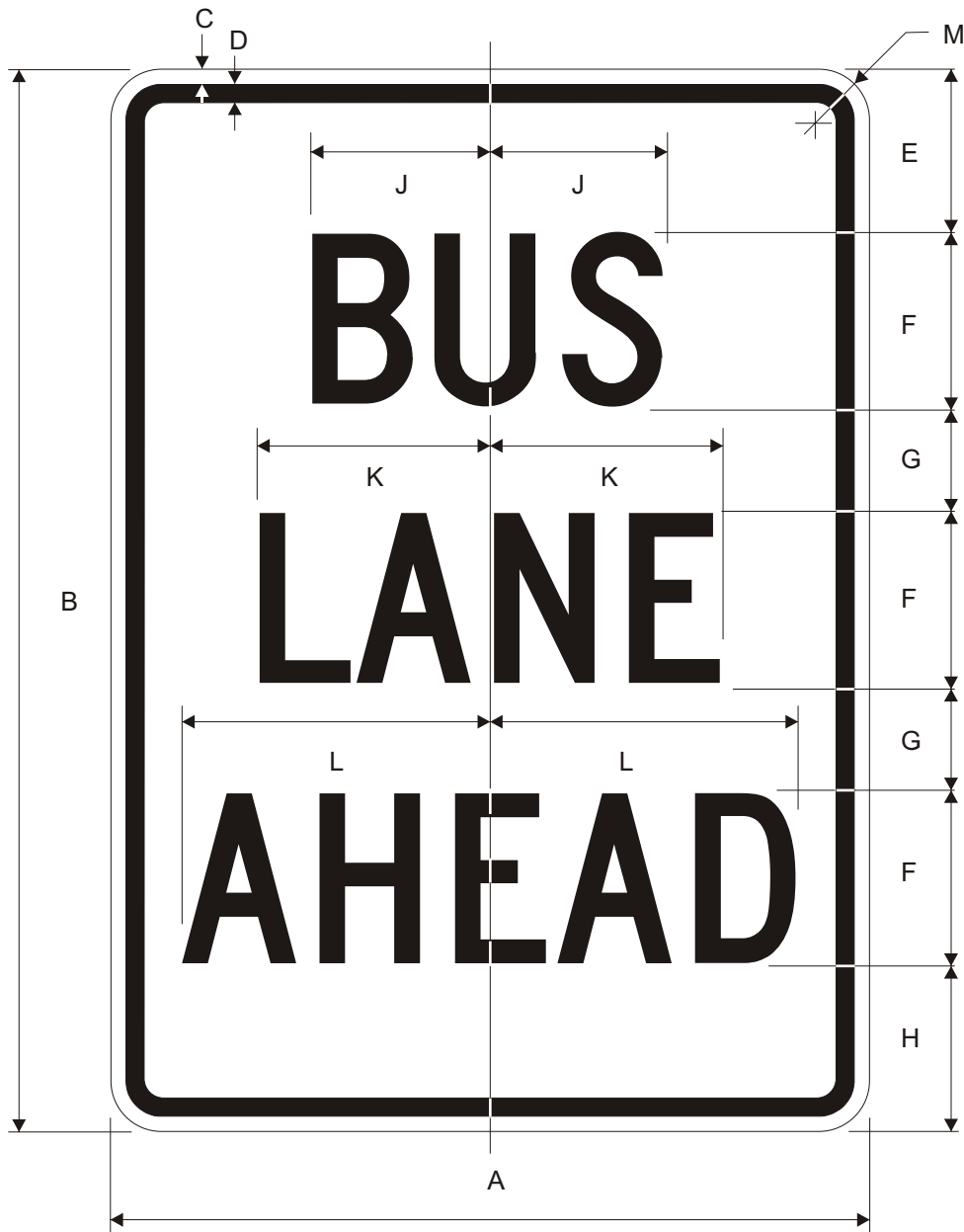

Road Class	Dimensions (inches)											
	A	B	C	D	E	F	G	H	J	K	L	M
Conv	30	42	0.5	0.75	6.5	7C	4	6.5	7.05	9.21	12.21	1.88
Expy	36	60	0.63	0.88	10	8C	8	10	8.04	10.50	13.94	2.25
Fwy	78	96	1	1.25	13	16C	11	13	16.08	21.01	27.89	3

Border and Legend: Black
Background: White

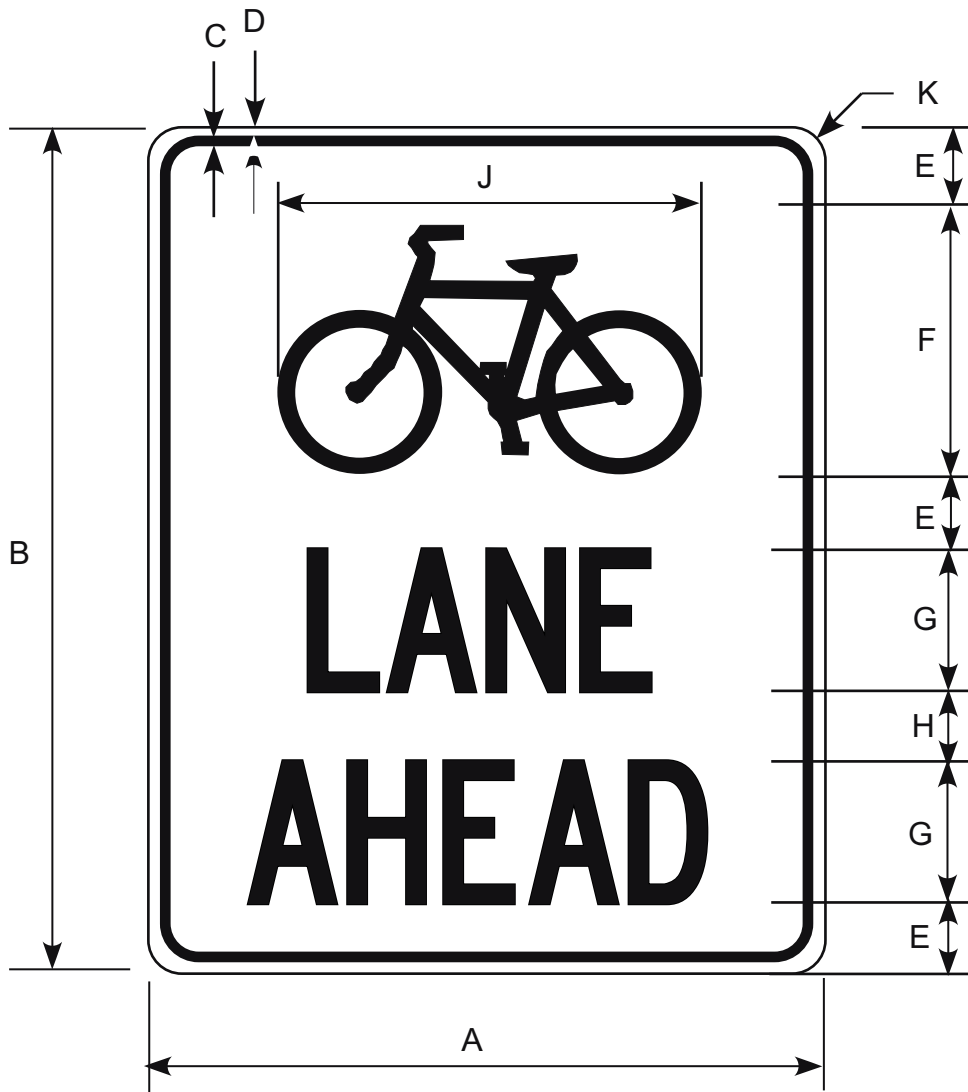

Border, Symbol, and Legend: Black
 Background: White

Make symbol proportional
 to the one shown.

Road Class	Dimensions (inches)									
	A	B	C	D	E	F	G	H	J	K
Conv & Min	24	30	0.63	0.38	3.5	7	5C	2.5	14	1.5

R3-16A

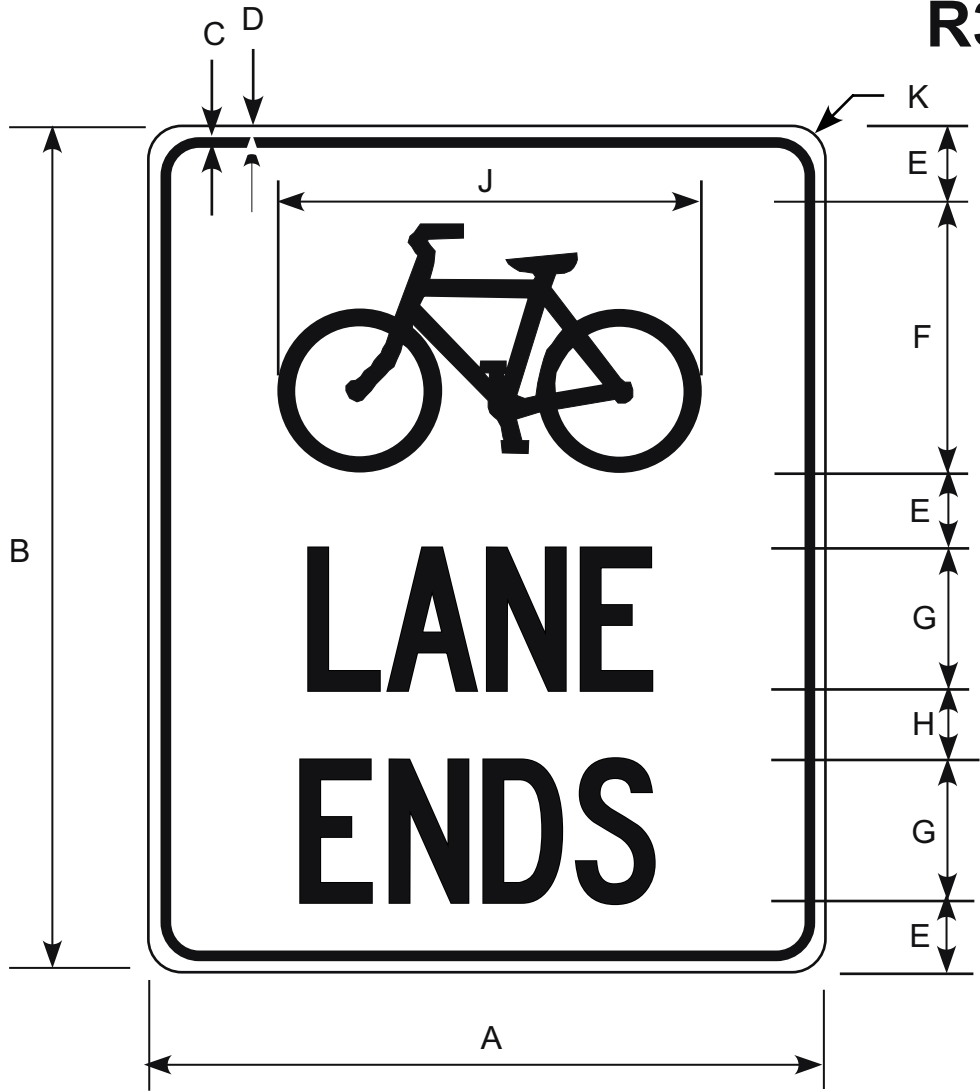

Border, Symbol, and Legend: Black
Background: White

Make symbol proportional
to the one shown.

Road Class	Dimensions (inches)									
	A	B	C	D	E	F	G	H	J	K
Conv & Min	24	30	0.63	0.38	3.5	7	5C	2.5	14	1.5



Circle and Diagonal: Red
 Border and Symbol: Black
 Background: White

*See Appendix B-1 for Standard Arrow Details.

Road Class	Dimensions (inches)										
	A	B	C	D	E	F	G	H	J	K	L
Minimum	24	0.38	0.63	10.41	8.57	2.08	3.68	1.84	6.81	0.4	1.58
Conventional	30	0.5	0.75	13	10.73	2.6	4.6	2.28	8.53	0.48	1.8
Expwy/Fwy	36	0.63	0.88	15.61	12.89	3.12	5.52	2.72	10.25	0.56	2.16
Oversized	48	0.75	1.25	20.82	17.13	4.16	7.37	3.68	13.61	0.8	2.88

M	N	P	Q	R	S
4.32	2.24	2.92	1.60	8.09	1.5
5.40	2.8	3.64	2.0	10.09	1.88
6.48	3.36	4.36	2.4	12.09	2.25
8.65	4.48	5.84	3.2	16.172	3.0

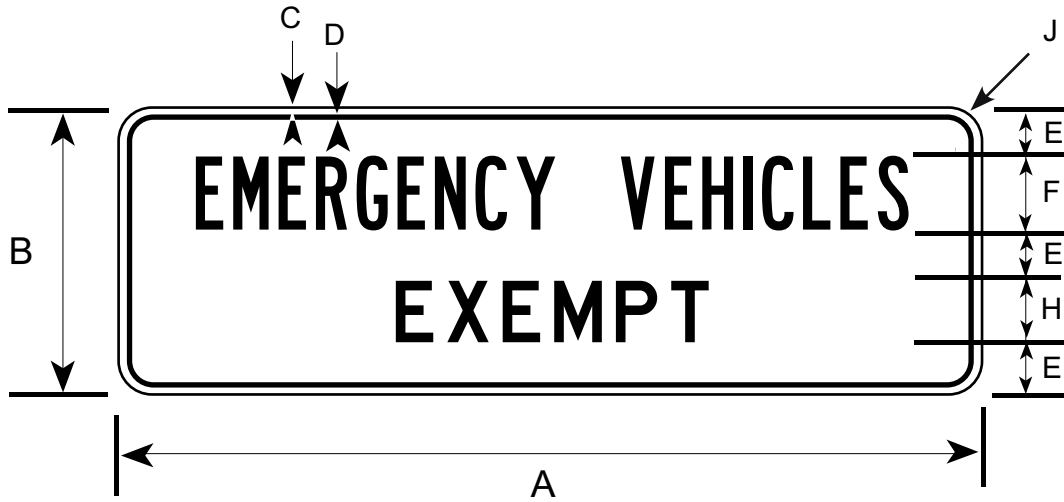

Border and Legend: Black
Background: White

Plaque associated with R3-4,
- With Expressway/Freeway crossovers

Road Class	Dimensions (inches)							
	A	B	C	D	E	F	H	J
Expy/Frwy	36	12	0.38	0.63	2.0	3B	3C	2.25



TOP
 Legend: White
 Background: Black

BOTTOM
 Border and Legend: Black
 Background: White

*Make symbol proportional to the graphic shown.

Prior to 2006 publication of this manual, this sign was numbered R3-17.

Road Class	Dimensions (inches)											
	A	B	C	D	E	F	G	H	J	K	L	M
Conv & Min	24	30	0.38	0.63	2.5	3D	2	6	4	5C	10.5	1.5

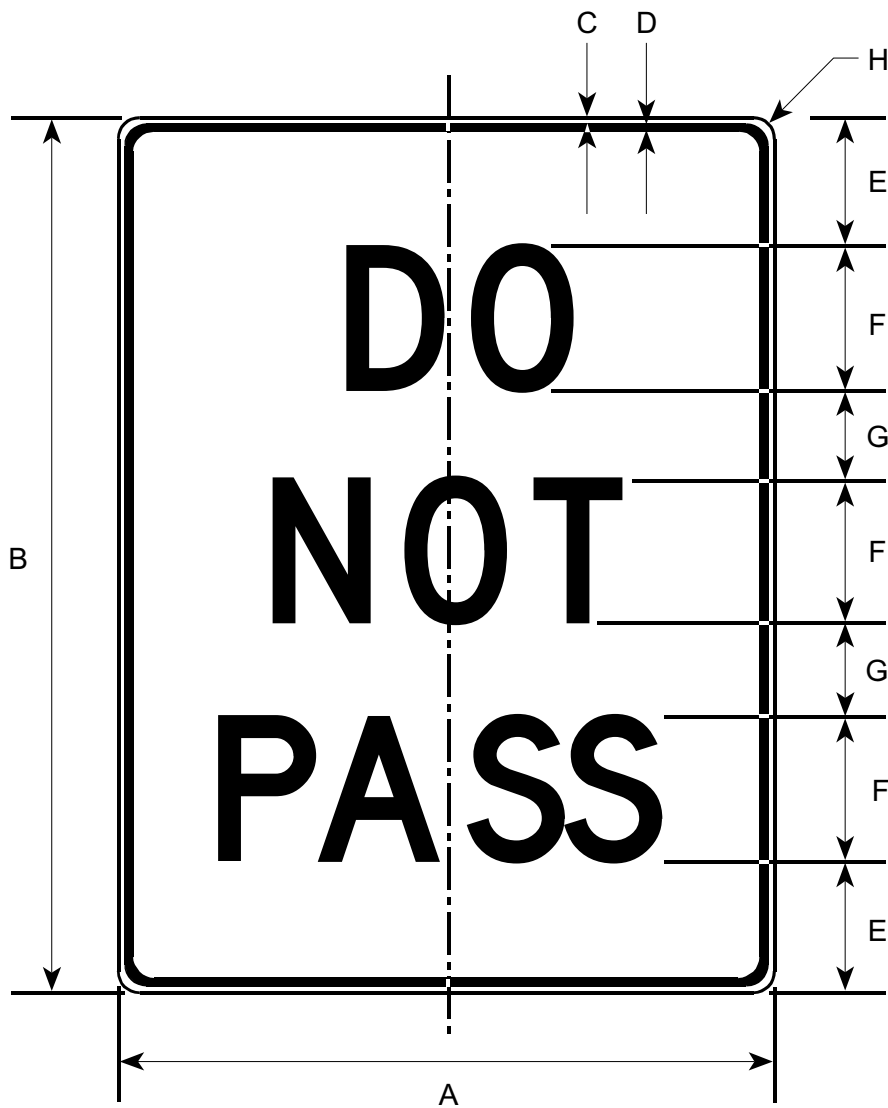

Border and Legend: Black
Background: White

Road Class	Dimensions (inches)							
	A	B	C	D	E	F	G	H
Minimum	24	30	0.38	0.63	3.5	6D	2.5	1.50
Conventional	30	36	0.50	0.75	4.5	7C	3.0	1.88
Expressway	36	48	0.63	0.88	7.0	8D	5.0	2.25
Freeway	48	60	0.75	1.25	8.0	10D	7.0	3.00

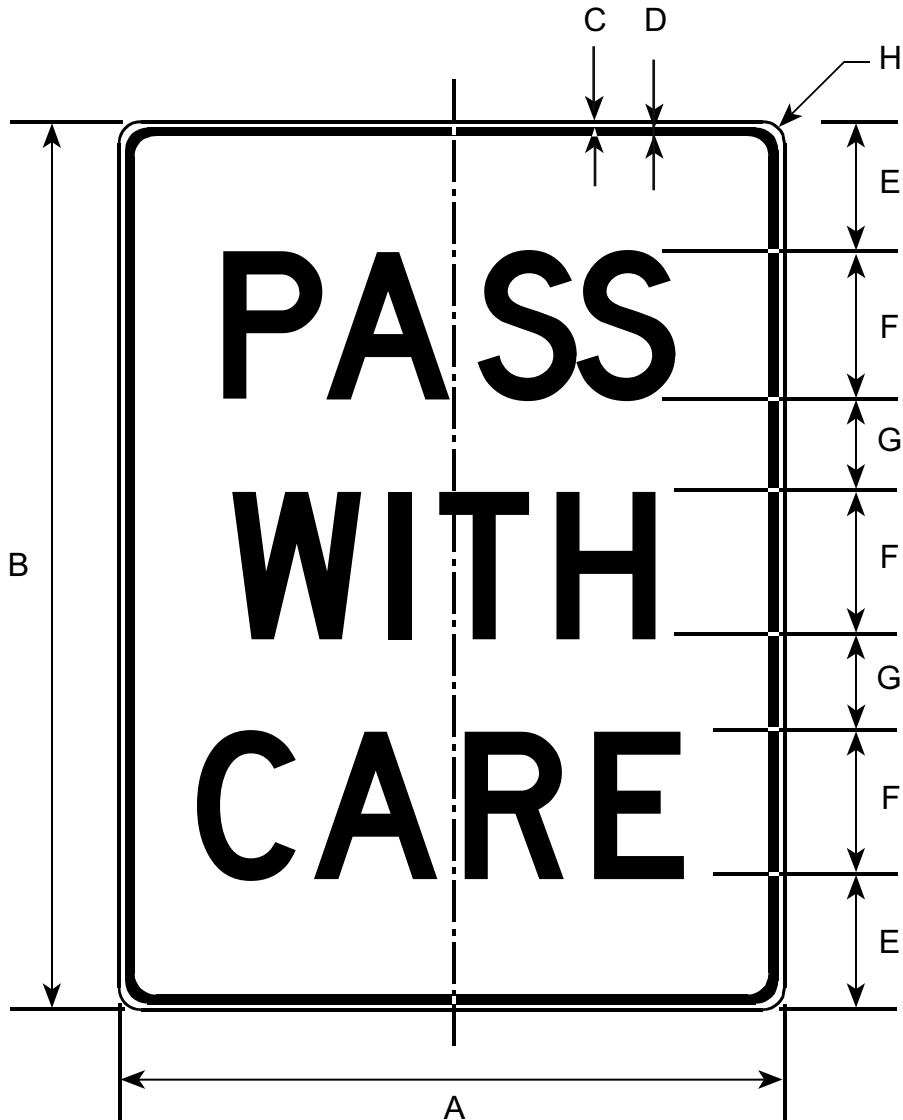

Border and Legend: Black
Background: White

Road Class	Dimensions (inches)							
	A	B	C	D	E	F	G	H
Minimum	24	30	0.38	0.63	3.5	6C	2.5	1.50
Conventional	30	36	0.50	0.75	4.5	7C	3.0	1.88
Expressway	36	48	0.63	0.88	7.0	8C	5.0	2.25
Freeway	48	60	0.75	1.25	8.0	10C	7.0	3.00



Border and Legend: Black
 Background: White

Road Class	Dimensions (inches)							
	A	B	C	D	E	F	G	H
Minimum	24	30	0.38	0.63	3.63	4D	2.25	1.50
Conventional	36	48	0.63	0.88	6.00	6D	4.00	2.25
Expwy & Fwy	48	60	0.75	1.25	7.25	8D	4.50	3.00

R4-4

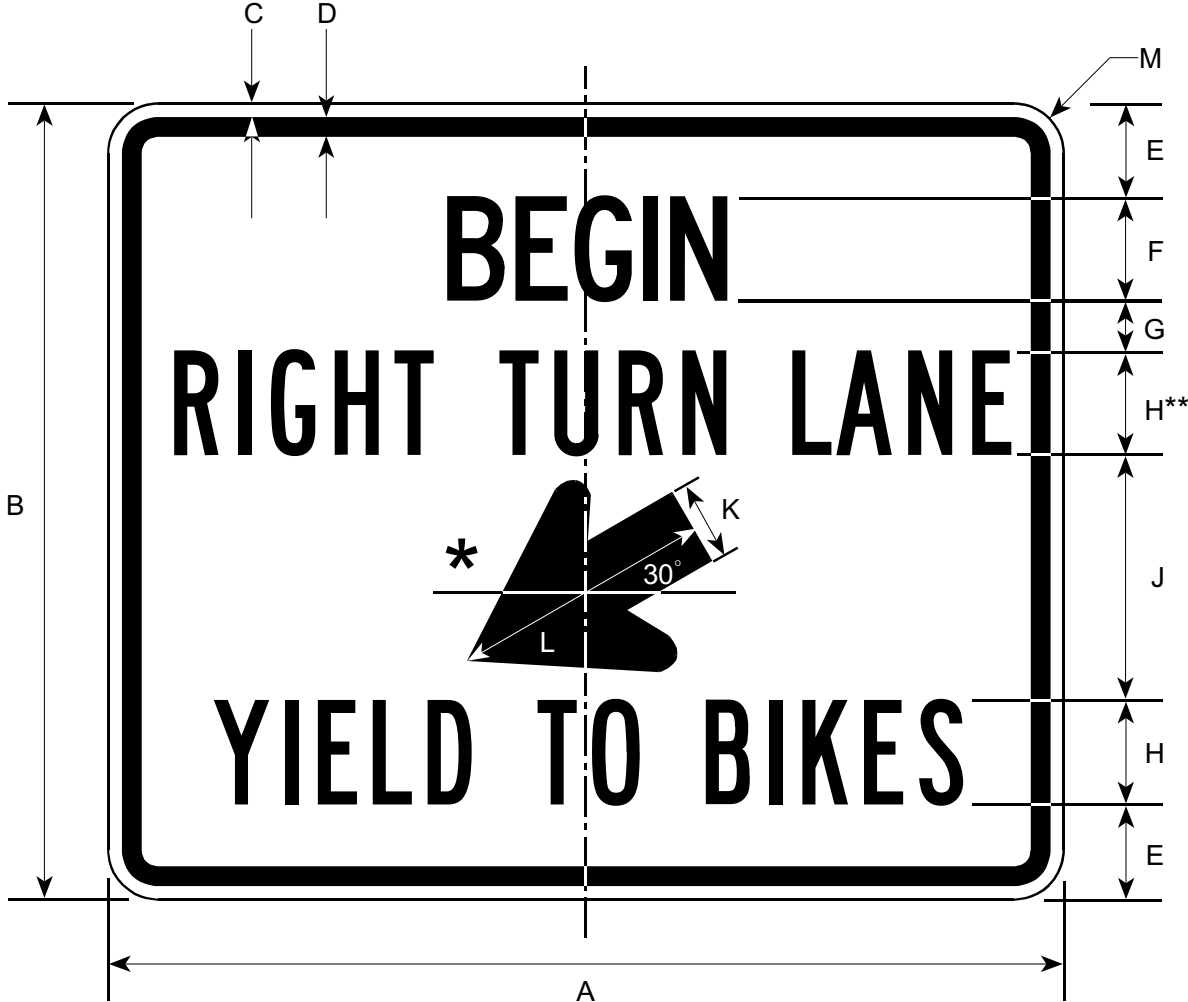

Border and Legend: Black
 Background: White

*See Appendix B-1 for Standard Arrow Details.
 ** Reduce letter spacing 20%.

Road Class	Dimensions (inches)												
	A	B	C	D	E	F	G	H	J	K	L	M	
Conv & Min	36	30	0.50	0.75	3.50	4C	2	4B	9	3.25	10	1.88	

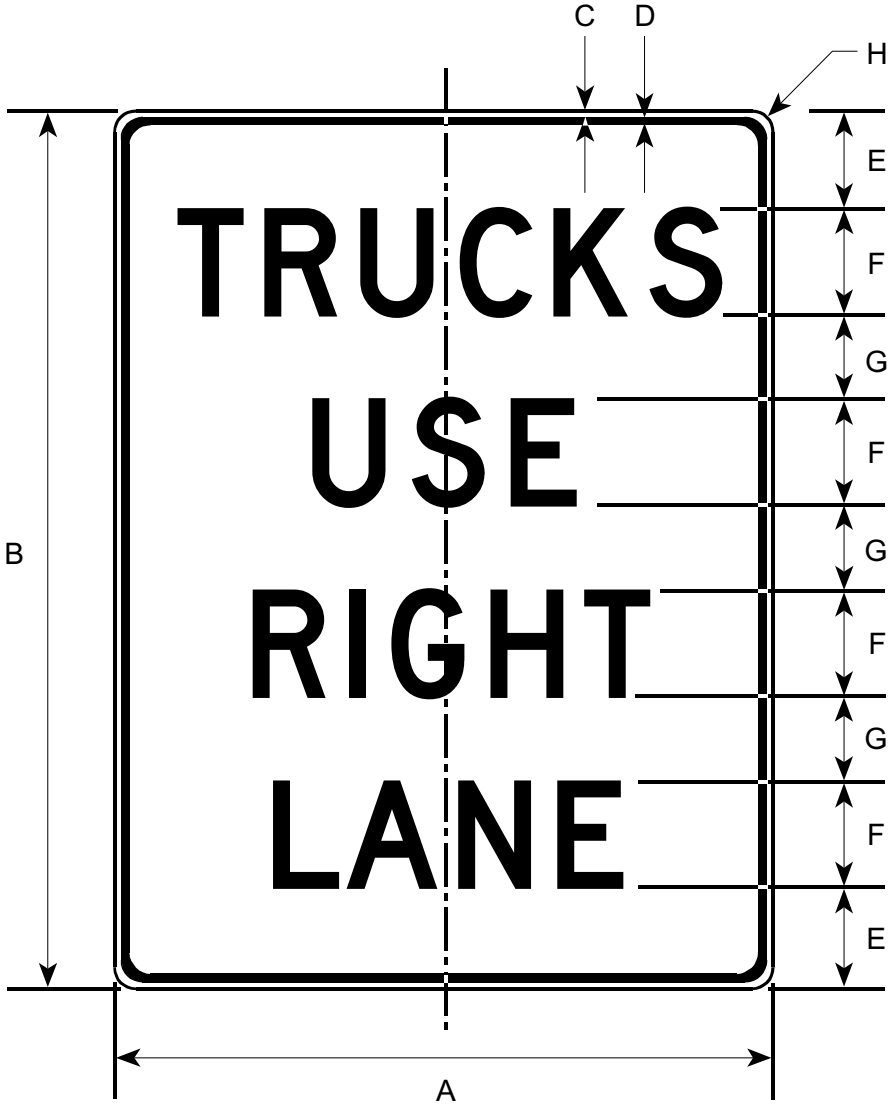

Border and Legend: Black
 Background: White

Road Class	Dimensions (inches)							
	A	B	C	D	E	F	G	H
Conv & Min	36	48	0.63	0.88	6.00	6D	4.0	2.25
Expwy & Fwy	48	60	0.75	1.25	7.25	8D	4.5	3.00

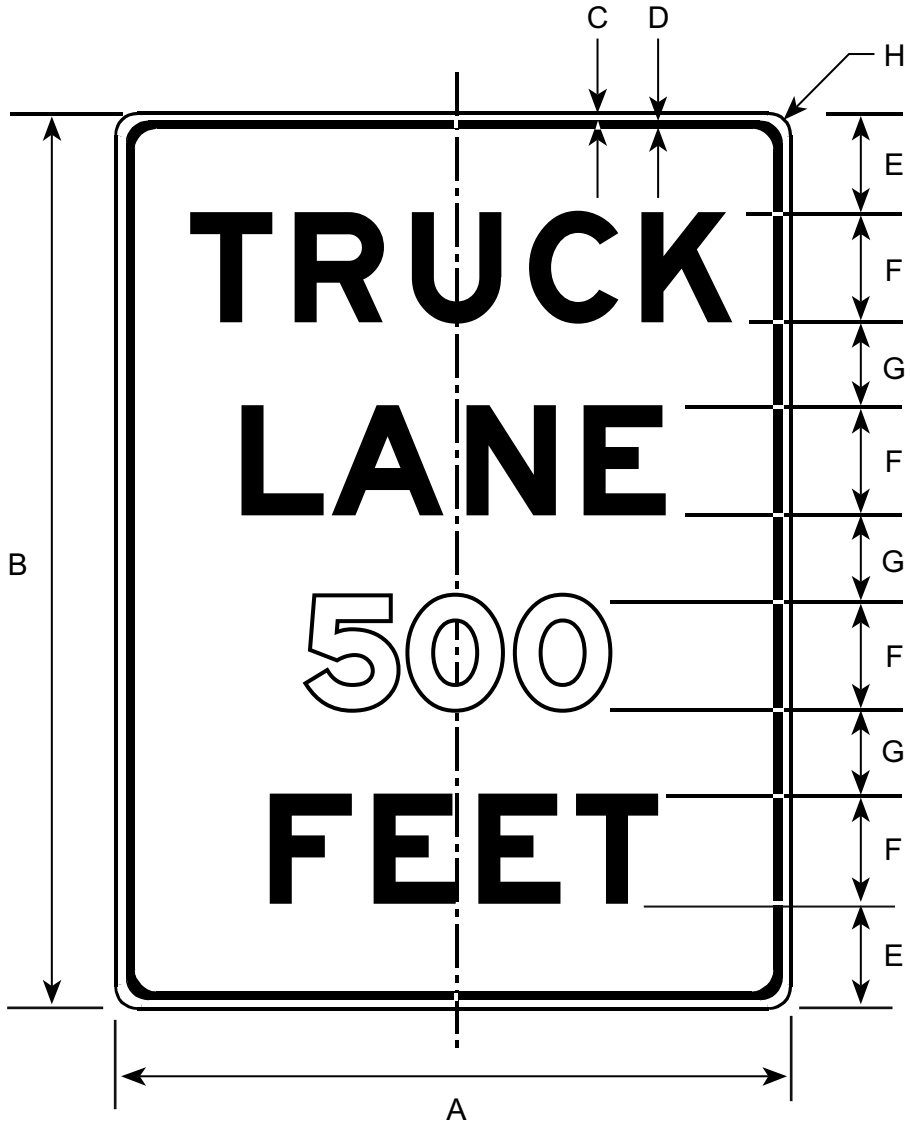

Border and Legend: Black
Background: White

Road Class	Dimensions (inches)							
	A	B	C	D	E	F	G	H
Minimum	24	30	0.38	0.63	4	4E	2.25	1.5
Conventional	36	48	0.63	0.88	6.00	6E	4.00	2.25
Expwy & Fwy	48	60	0.75	1.25	7.25	8E	4.50	3.00

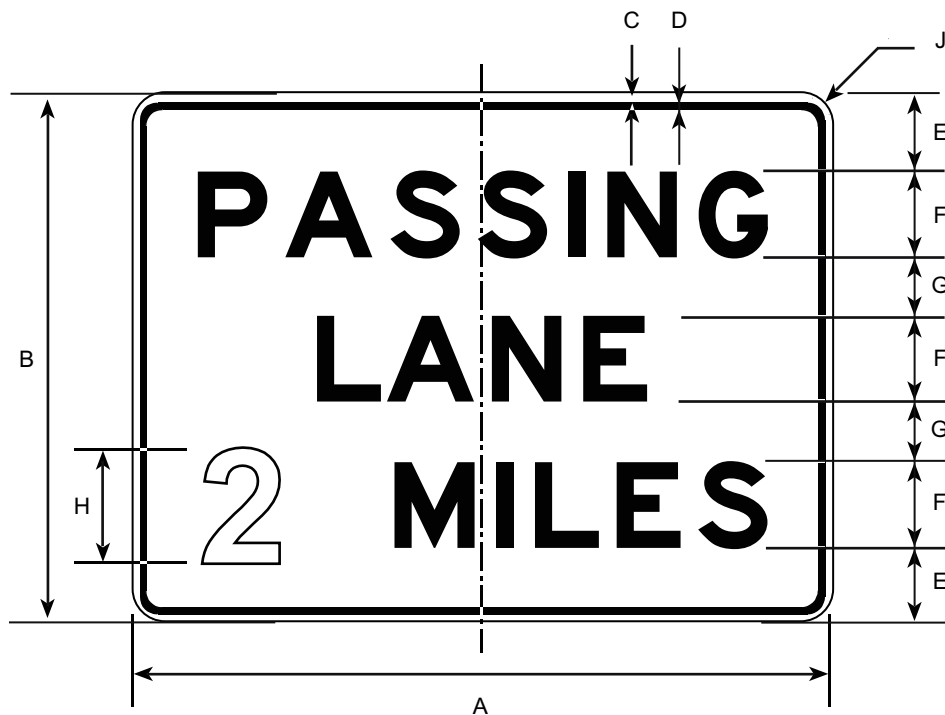

Border and Legend: Black
Background: White

Road Class	Dimensions (inches)									
	A	B	C	D	E	F	G	H	J	
Conv & Min	48	36	0.63	0.88	5	6E	4	8E	2.25	

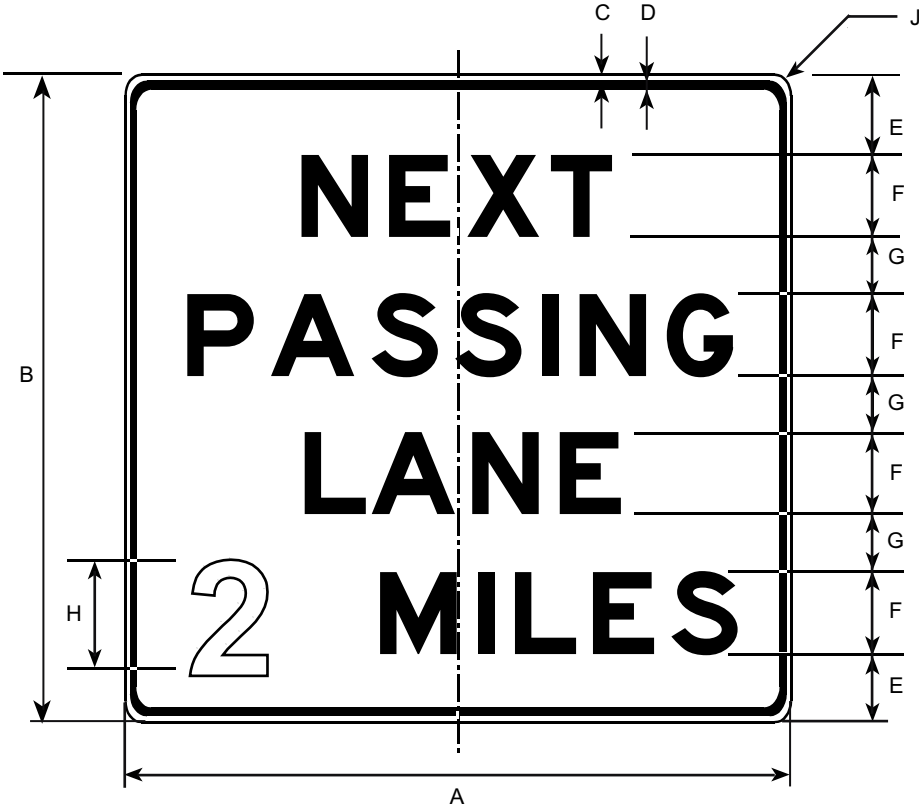

Border and Legend: Black
 Background: White

Road Class	Dimensions (inches)								
	A	B	C	D	E	F	G	H	J
Conv & Min	48	48	0.63	0.88	6	6E	4	8E	2.25

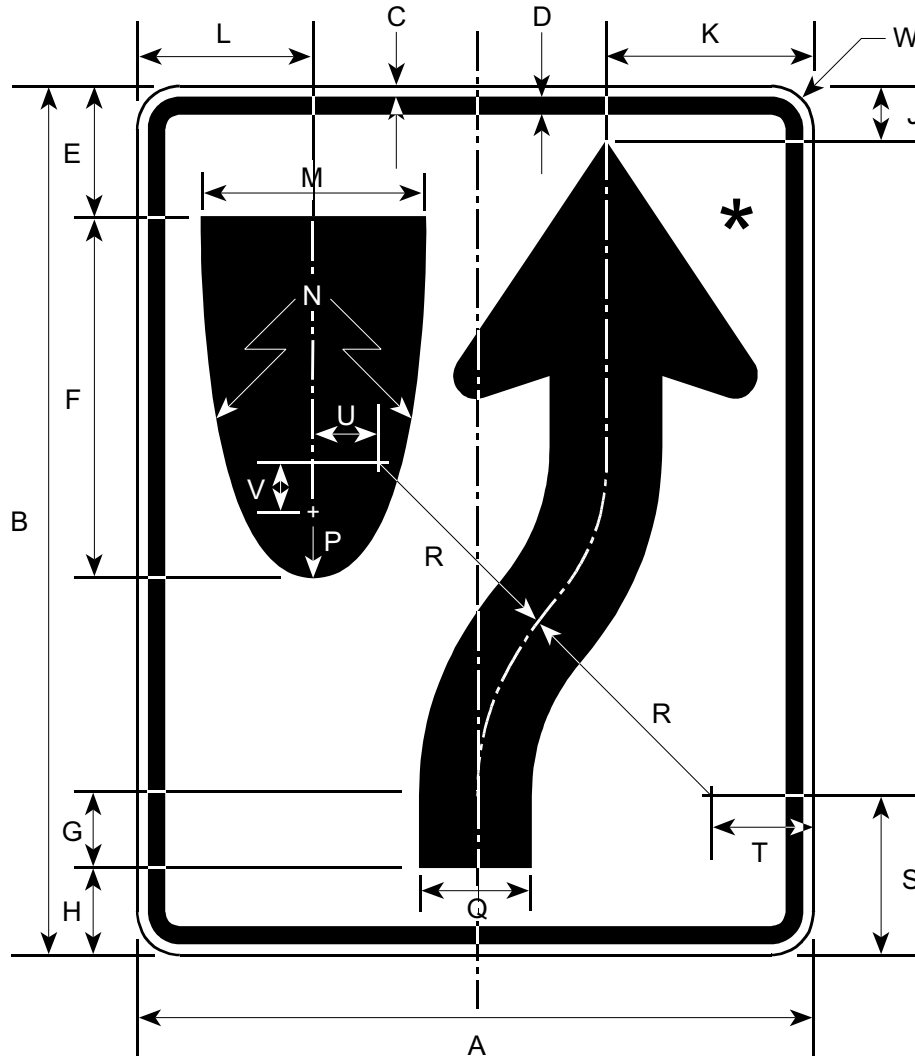

Border and Legend: Black
Background: White

*See Appendix B-1 for Standard Arrow Details.

Road Class	Dimensions (inches)																				
	A	B	C	D	E	F	G	H	J	K	L	M	N	P	Q	R	S	T	U	V	W
Minimum	18	24	0.38	0.63	3.38	9.38	1.88	2.25	1.38	5.5	4.69	6	22.5	1.5	3.0	6.75	4.13	2.25	1.06	0.44	1.5
Conv.	30	36	0.50	0.75	5.5	15.25	3.0	3.5	2.38	9.25	7.25	10	36	2.5	5.0	9.82	6.5	5.19	3.19	2.63	1.88
Expwy.	36	48	0.63	0.88	6.75	18.75	3.75	4.5	2.81	11.13	9.38	12	45	3.0	6.0	13.5	8.25	4.50	2.0	2.75	2.25
Oversized	48	60	0.75	1.25	9.0	25	5.0	6.0	3.75	14.81	12.5	16	60	4.0	8.0	18	11	6.0	2.69	5.0	3.0

R4-7A

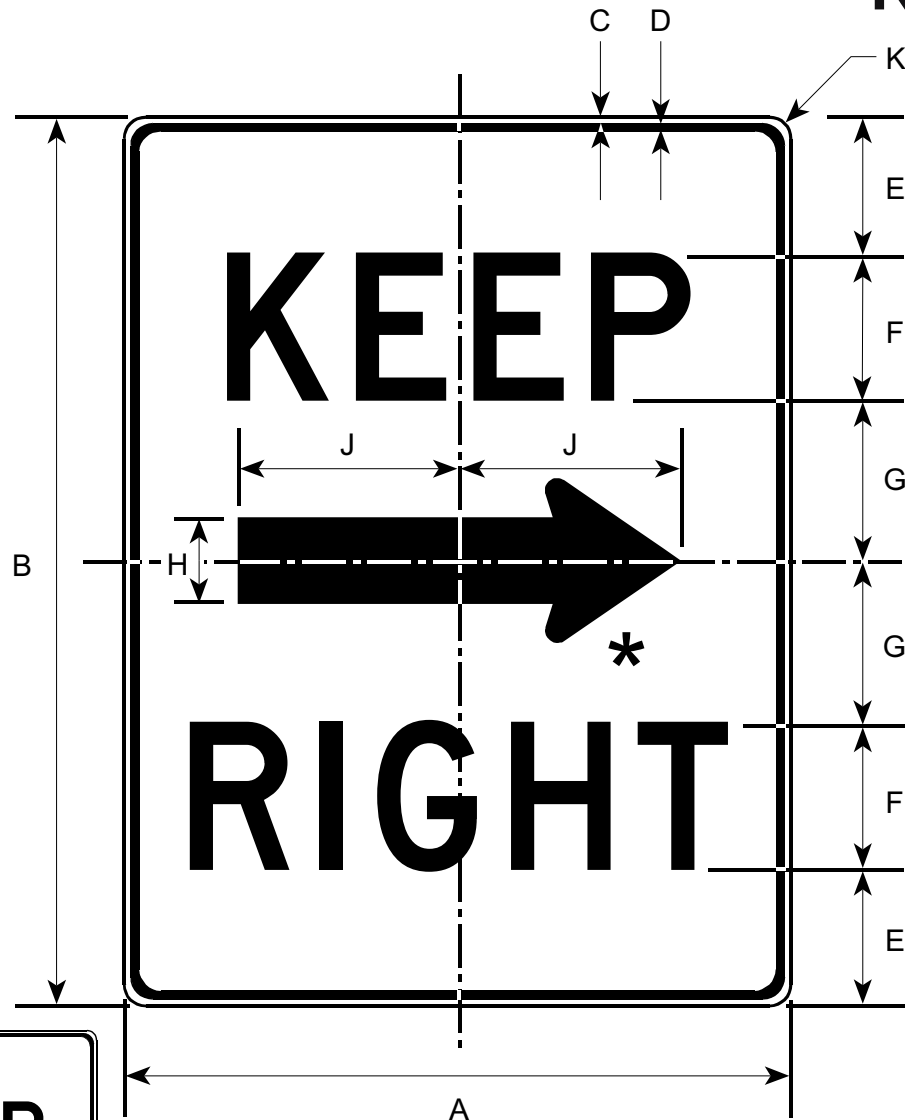

R4-7AR



R4-7AL

Border and Legend: Black
Background: White

*See Appendix B-1 for Standard Arrow Details.

Road Class	Dimensions (inches)									
	A	B	C	D	E	F	G	H	J	K
Minimum	18	24	0.38	0.63	3.75	4D	4.25	2.25	6.00	1.50
Conventional	24	30	0.38	0.63	4.50	5D	5.50	2.63	7.13	1.50
Expressway	36	48	0.63	0.88	7.50	8D	8.50	4.50	11.50	2.25
Oversized	48	60	0.75	1.25	9.00	10D	11.00	5.25	14.25	3.00

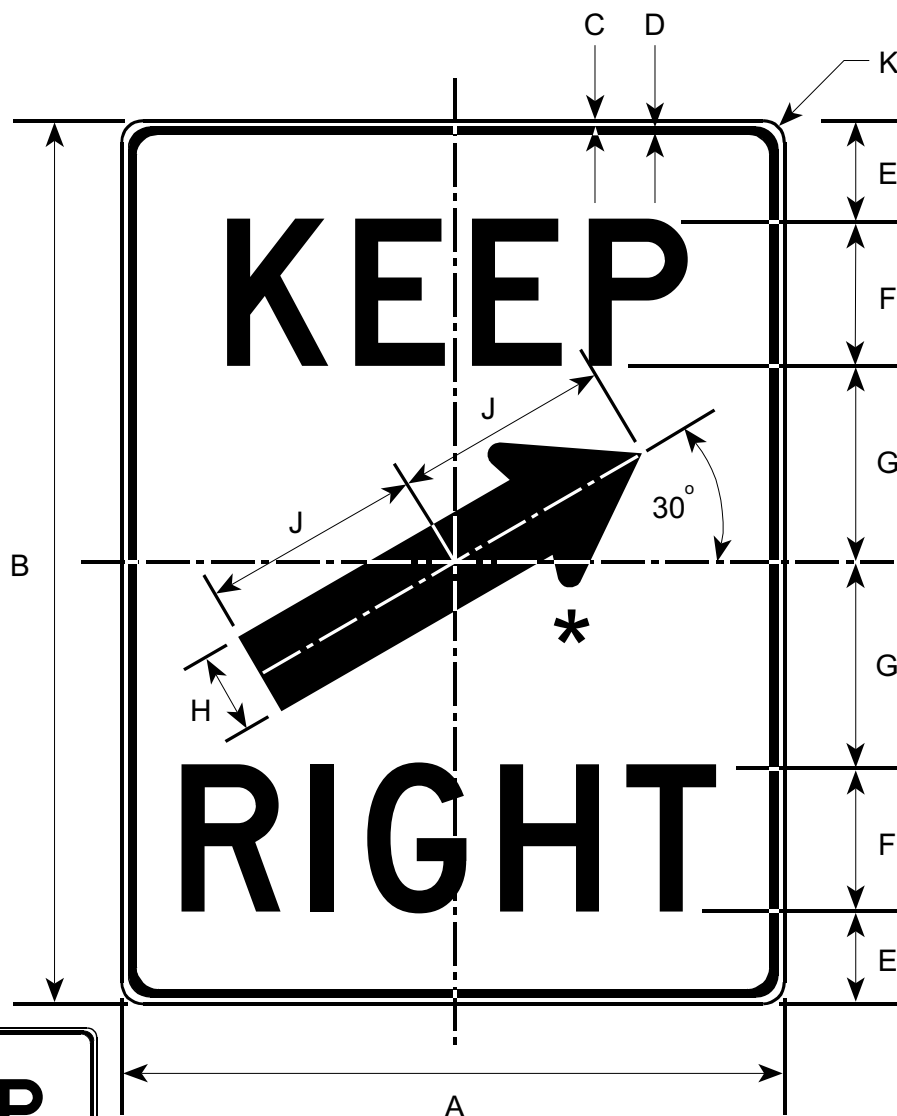

R4-7BR



R4-7BL

Border and Legend: Black
Background: White

*See Appendix B-1 for Standard Arrow Details.

Road Class	Dimensions (inches)									
	A	B	C	D	E	F	G	H	J	K
Minimum	18	24	0.38	0.63	2.5	4D	5.5	2.25	6.0	1.5
Conventional	24	30	0.38	0.63	3.0	5D	7.0	2.63	7.13	1.5
Expressway	36	48	0.63	0.88	5.0	8D	11	4.5	11.44	2.25
Oversized	48	60	0.75	1.25	6.0	10D	14	5.25	14.25	3.0

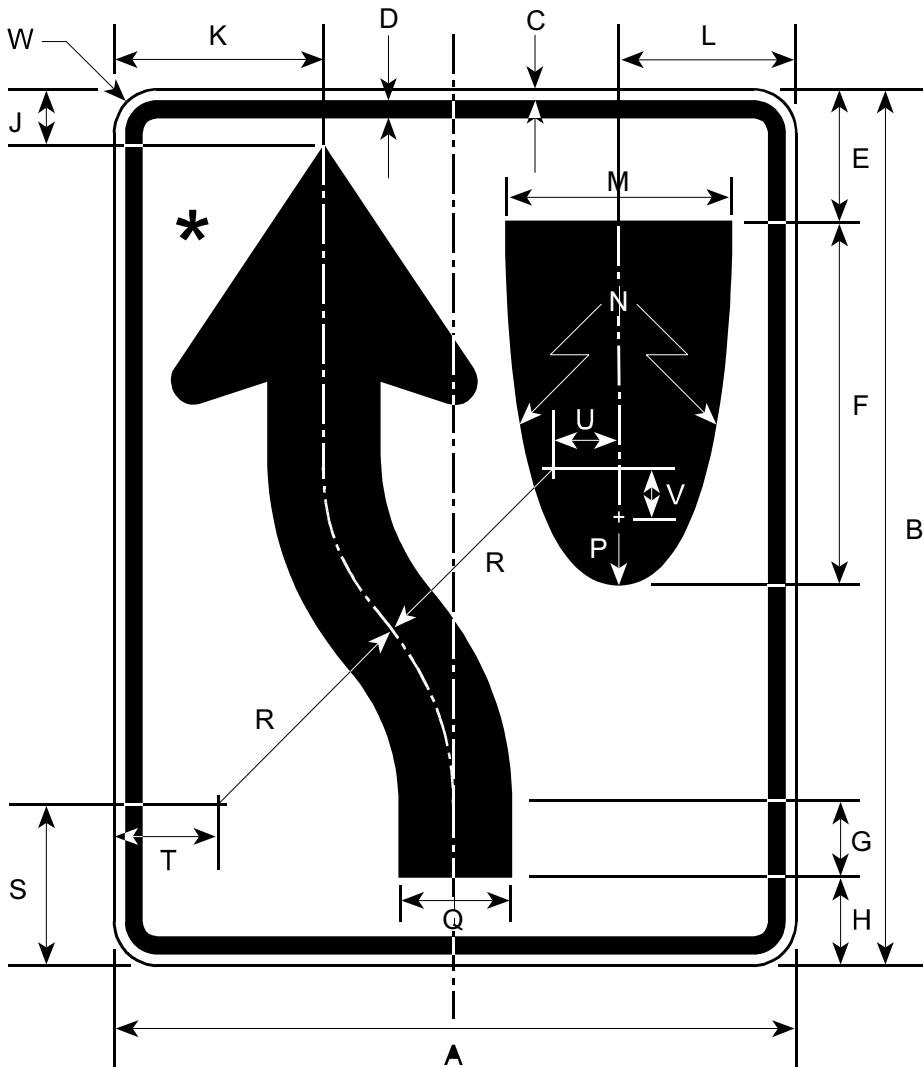

Border and Legend: Black
Background: White

*See Appendix B-1 for Standard Arrow Details.

Road Class	Dimensions (inches)																				
	A	B	C	D	E	F	G	H	J	K	L	M	N	P	Q	R	S	T	U	V	W
Minimum	18	24	0.38	0.63	3.38	9.38	1.88	2.25	1.38	5.5	4.69	6.0	22.5	1.5	3.0	6.75	4.13	2.25	1.06	0.44	1.5
Conv.	24	30	0.38	0.63	4.5	12.5	2.5	3.0	1.88	7.38	6.25	8.0	30	2.0	4.0	9.0	5.5	3.0	1.38	2.81	1.5
Expwy.	36	48	0.63	0.88	6.75	18.75	3.75	4.50	2.81	11.13	9.38	12	45	3.0	6.0	13.5	8.25	4.5	2.0	2.75	2.25
Oversized	48	60	0.75	1.25	9.0	25	5.0	6.0	3.75	14.81	12.5	16	60	4.0	8.0	18	11	6.0	2.69	5.0	3.0



Border and Legend: Black
 Background: White

* Reduce spacing to fit.

Road Class	Dimensions (inches)							
	A	B	C	D	E	F	G	H
Minimum	18	24	0.38	0.63	3.00	4D	3.00	1.50
Conventional	24	30	0.38	0.63	3.69	5D	3.81	1.50
Expressway	36	48	0.63	0.88	8.25	7D	5.25	2.25
Freeway	48	60	0.75	1.25	7.50	10D	7.50	3.00

R4-10

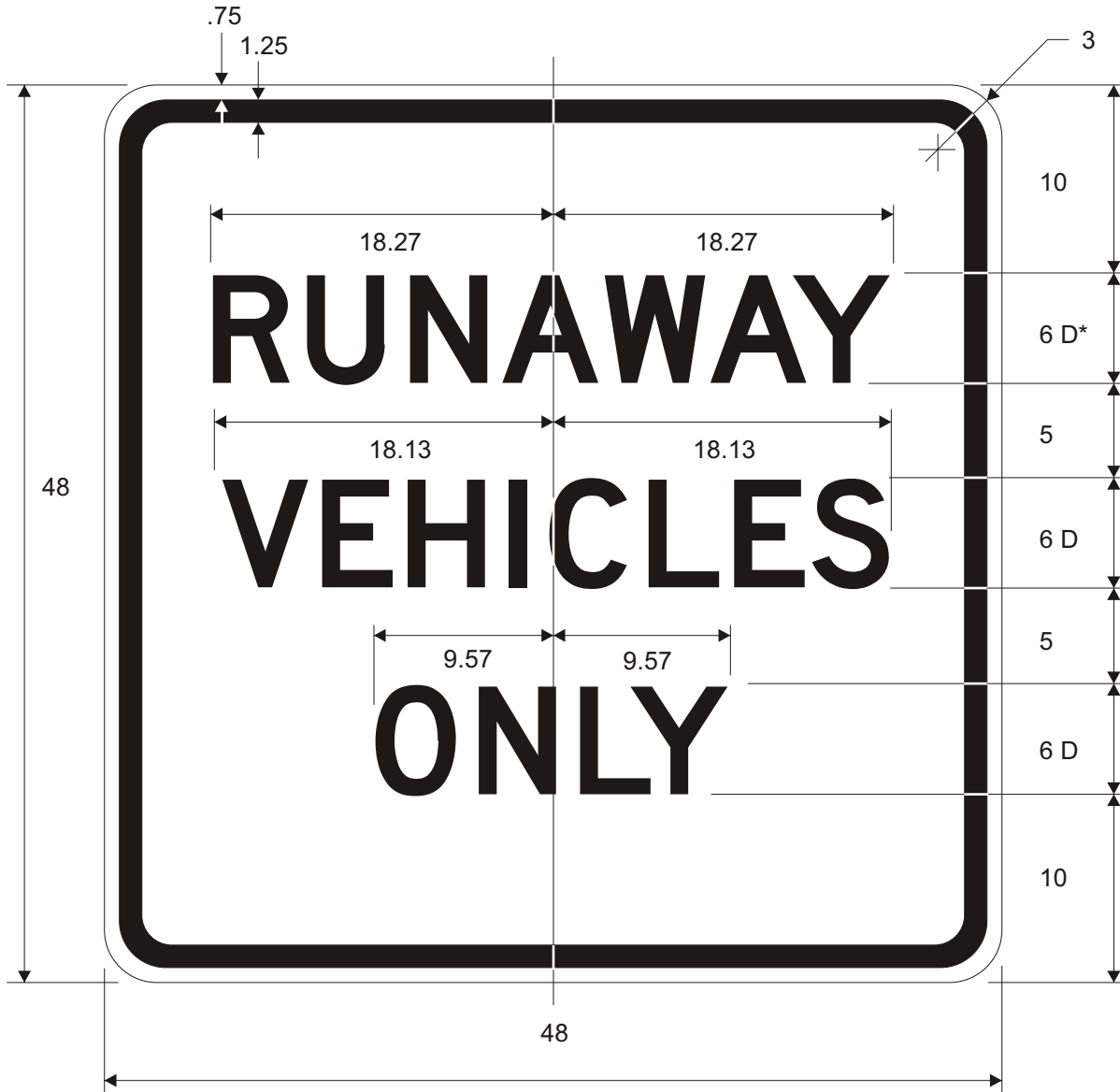

Border and Legend: Black
Background: White

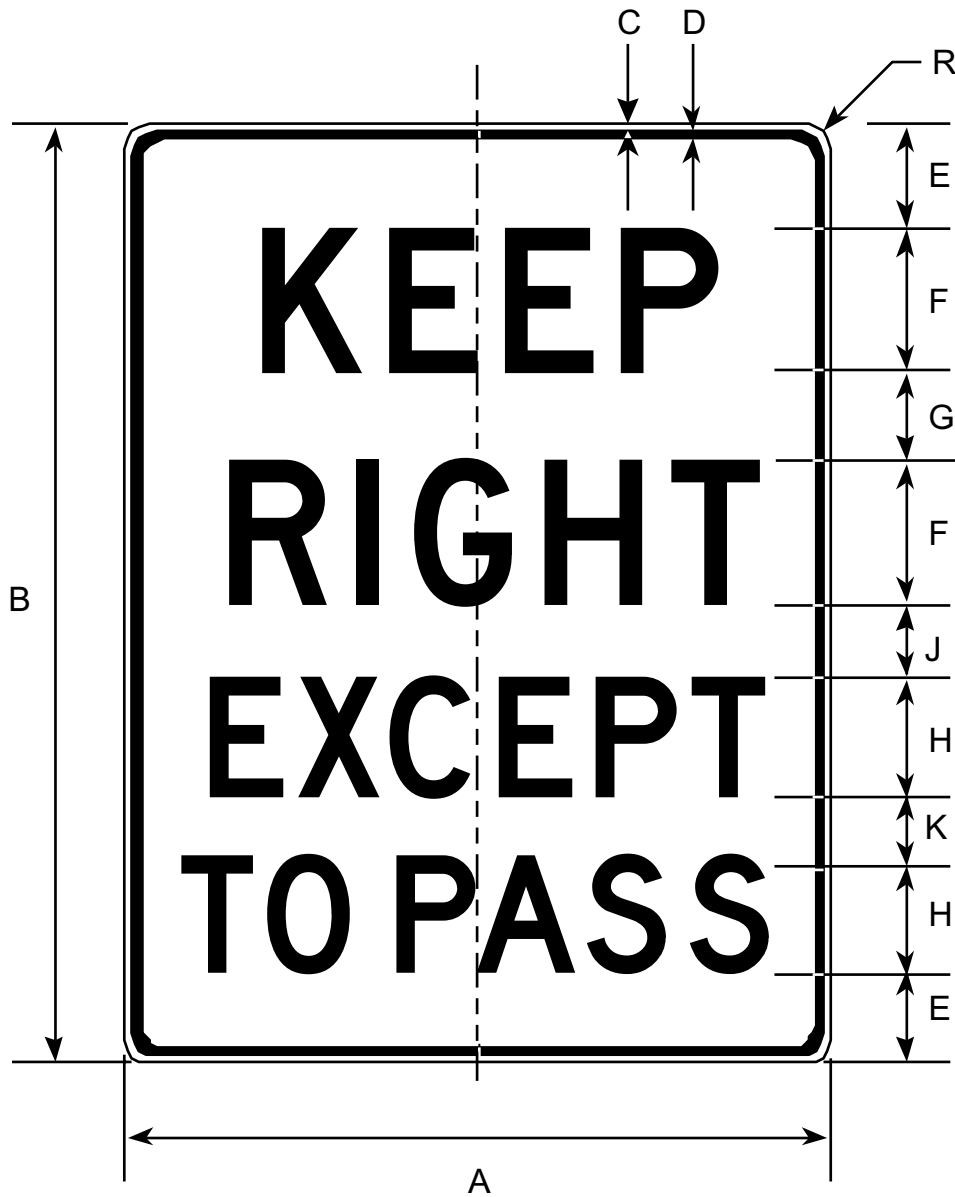

Border and Legend: Black
Background: White

Road Class	Dimensions (inches)										
	A	B	C	D	E	F	G	H	J	K	R
Conventional	36	48	0.63	0.88	4.0	8D	5	6C	4	3	2.25
Oversized	48	60	0.75	1.25	4.5	10D	6	8C	5	4	3.00

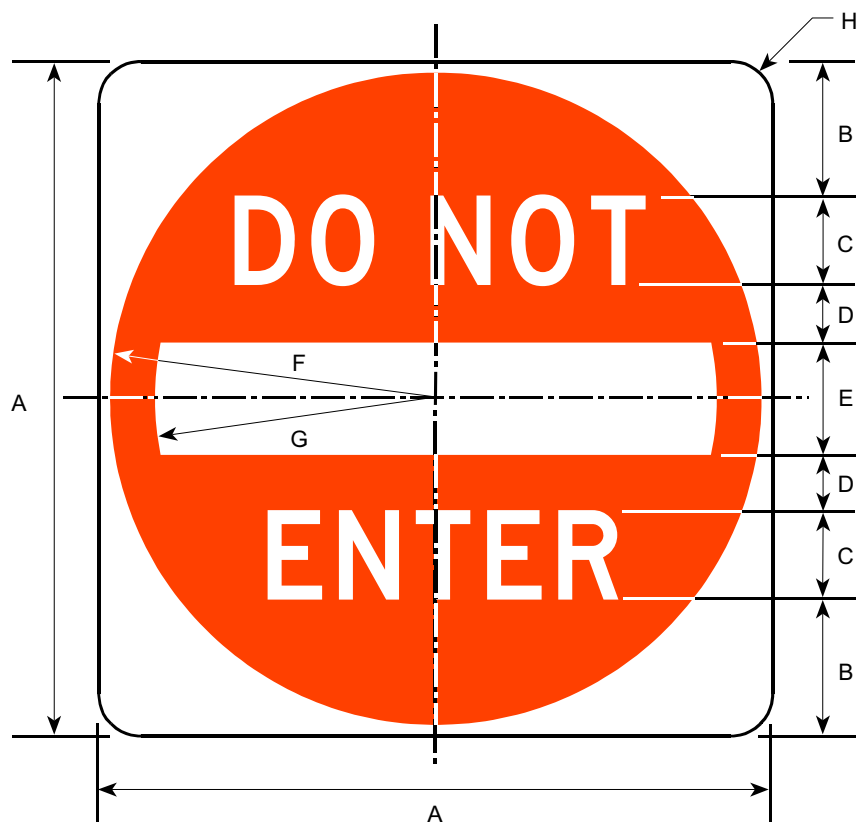

Border and Legend: White
Background: Red

Road Class	Dimensions (inches)							
	A	B	C	D	E	F	G	H
Minimum	30	6.5	4D	2.0	5	14.5	12.5	1.88
Conventional	36	7.5	5D	2.5	6	17.5	15.0	2.25
Expwy & Fwy	48	11.0	6D	3.0	8	23.5	20.0	3.00

R5-1A

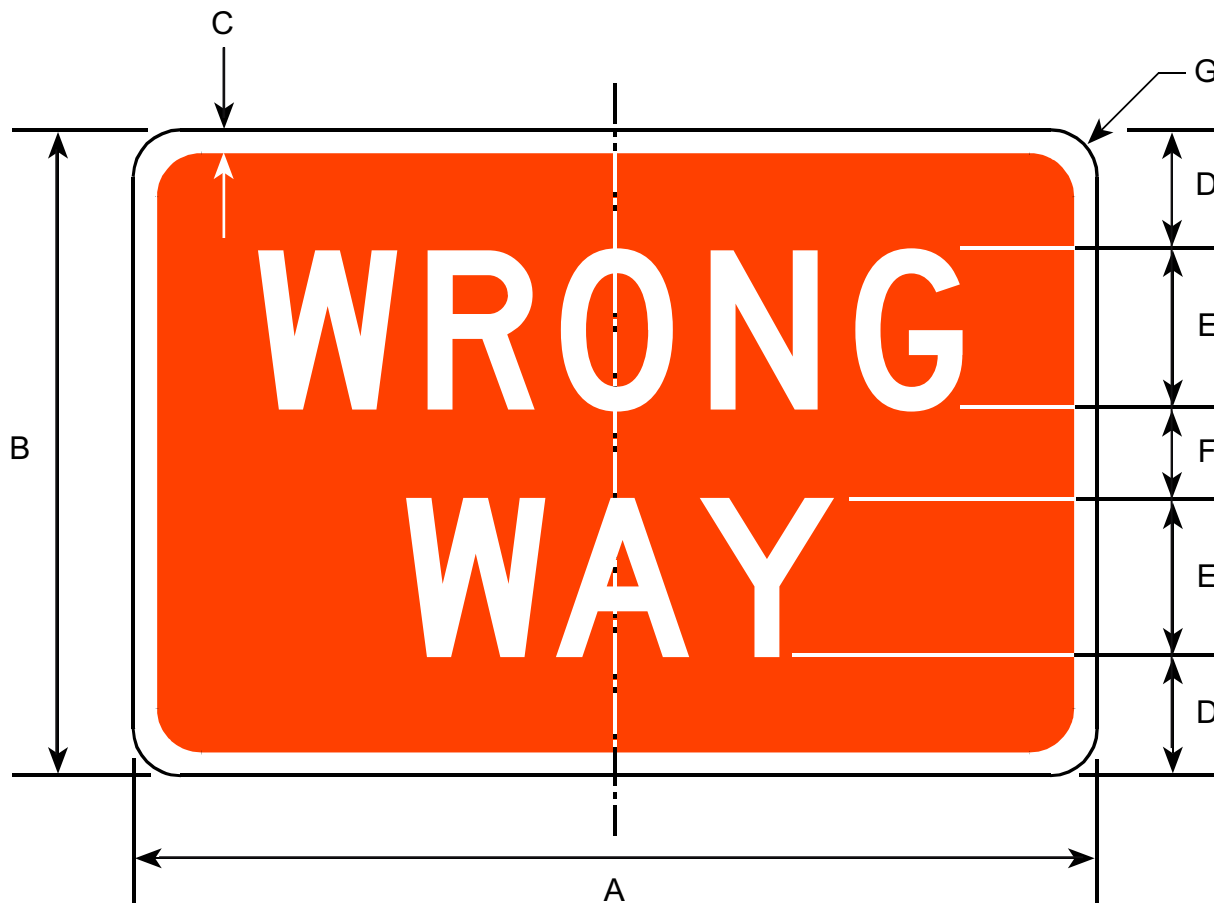

Border and Legend: White
Background: Red

Road Class	Dimensions (inches)						
	A	B	C	D	E	F	G
Minimum	30	18	0.63	3.0	5D	2	1.50
Conventional	36	24	0.75	4.5	6D	3	1.50
Expwy & Fwy	42	30	0.88	5.0	8D	4	1.88

R5-1B

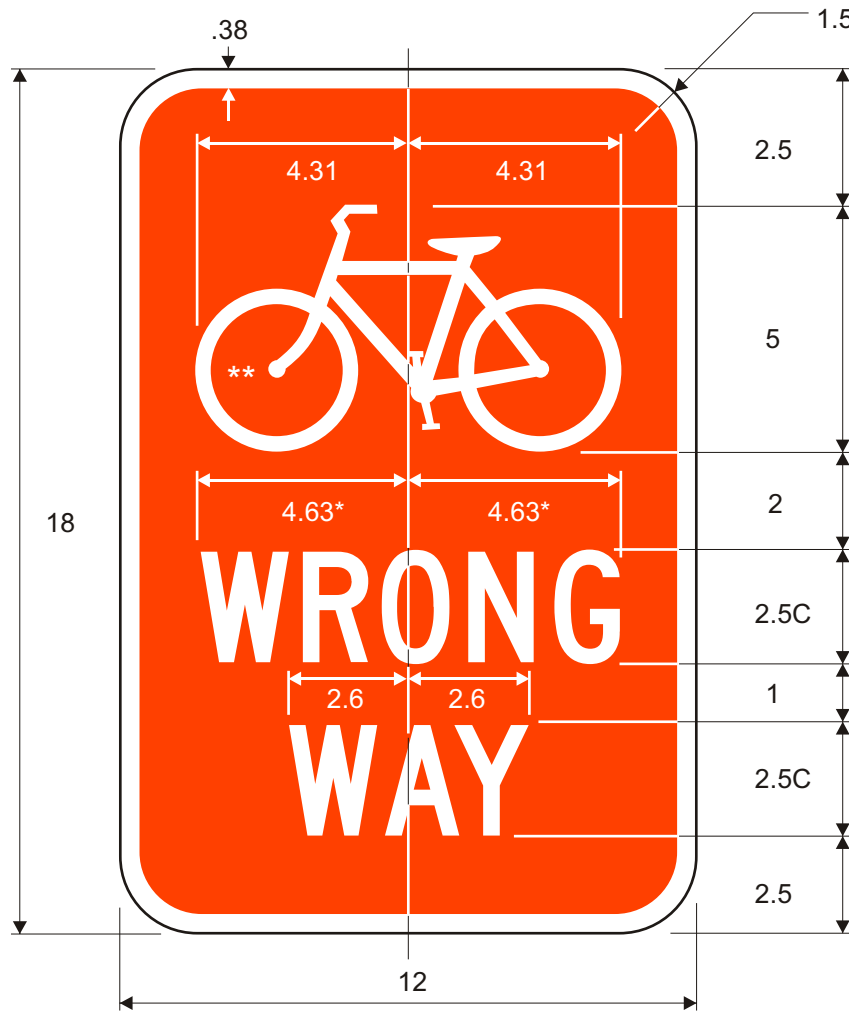

*Reduce spacing to fit.

Border and Legend: White
Background: Red

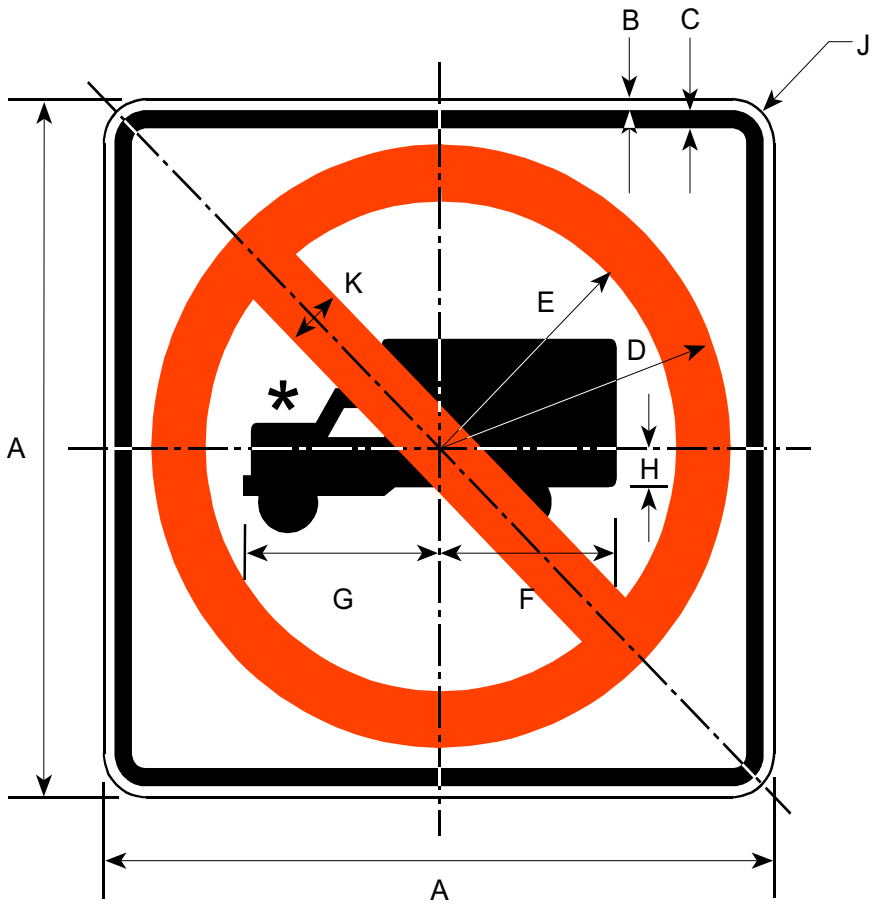

Circle & Diagonal: Red
 Border and Symbol: Black
 Background: White

*Make symbol proportional
 to the graphic shown.

Road Class	Dimensions (inches)									
	A	B	C	D	E	F	G	H	J	K
Minimum	24	0.38	0.63	10.5	8.5	6.5	6.88	1.38	1.5	1.0
Conventional	30	0.50	0.75	13.13	10.63	8.13	8.5	1.63	1.88	2.5
Expressway	36	0.63	0.88	15.75	12.75	9.75	10.25	2.0	2.25	3.0
Freeway	48	0.75	1.25	21	17	13	13.63	2.63	3.0	4.0

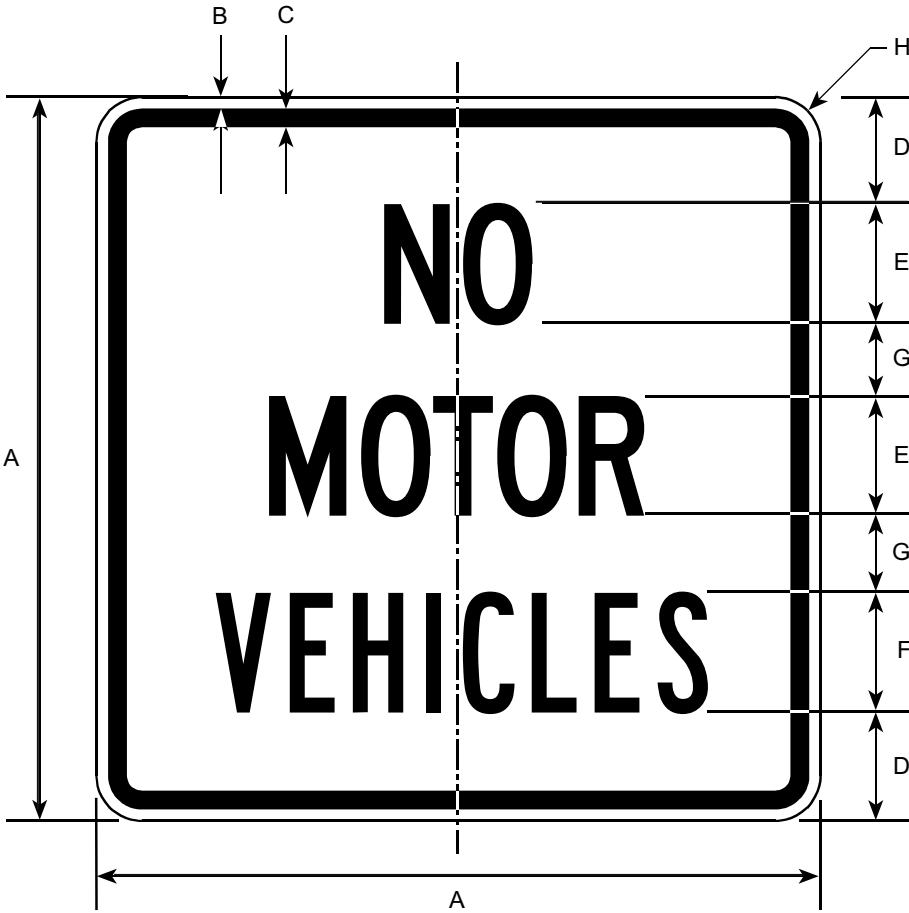

Border and Legend: Black
Background: White

Road Class	Dimensions (inches)							
	A	B	C	D	E	F	G	H
Minimum	18	0.38	0.63	2.5	3C	3B	2	1.5
Conventional	24	0.38	0.63	3.50	4C	4B	2.50	1.5

R5-3A
R5-3AP

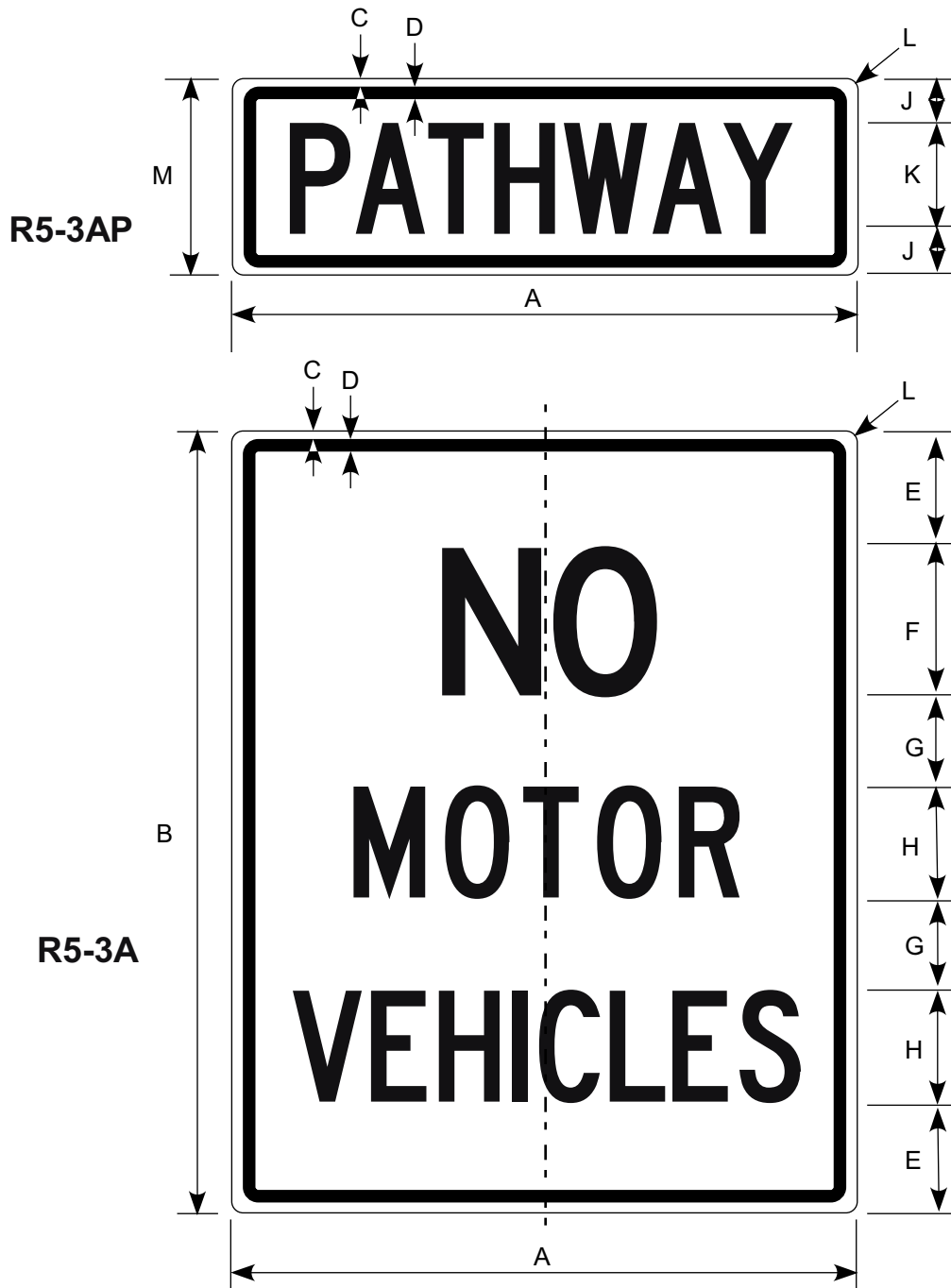

Border and Legend: Black
Background: White

Road Class	Dimensions (inches)											
	A	B	C	D	E	F	G	H	J	K	L	M
Minimum	12	18	0.38	0.63	3.0	3C	2.5	2B	2.0	2B	1.5	6.0
Conventional	18	24	0.38	0.63	4.0	4C	3.0	3B	1.5	3C	1.5	6.0

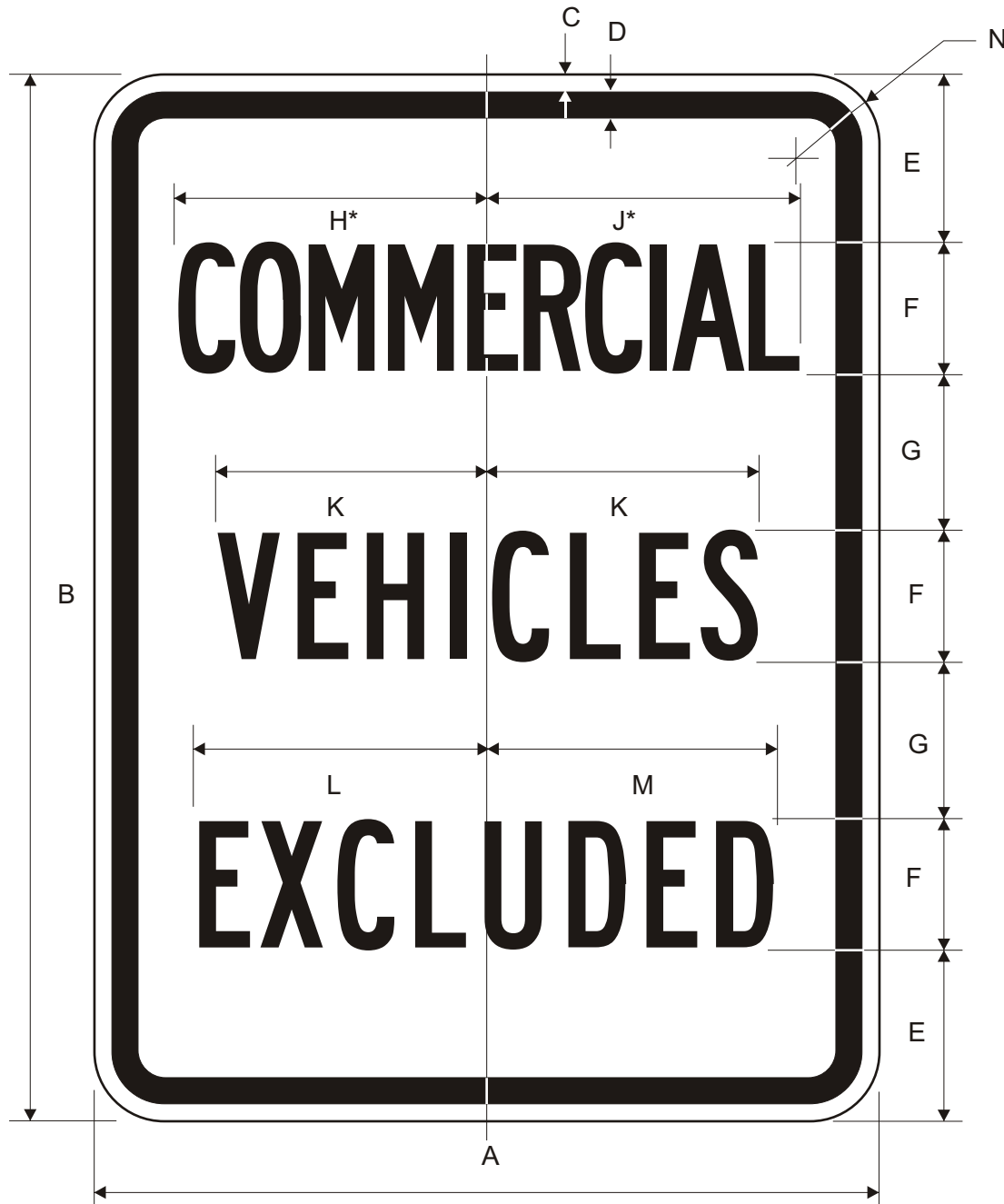

Border and Legend: Black
Background: White

*Reduce spacing 50%.

Road Class	Dimensions (inches)												
	A	B	C	D	E	F	G	H	J	K	L	M	N
Conv.	24	30	0.38	0.63	5.0	4B	4.0	9.5	9.81	8.25	8.69	6.69	1.5
Expy.	36	48	0.63	0.88	8.5	6B	6.5	14.25	14.69	12.38	13	13.38	2.25
Fwy.	48	60	0.75	1.25	10	8B	8.0	19	19.63	16.5	17.38	17.88	3.0

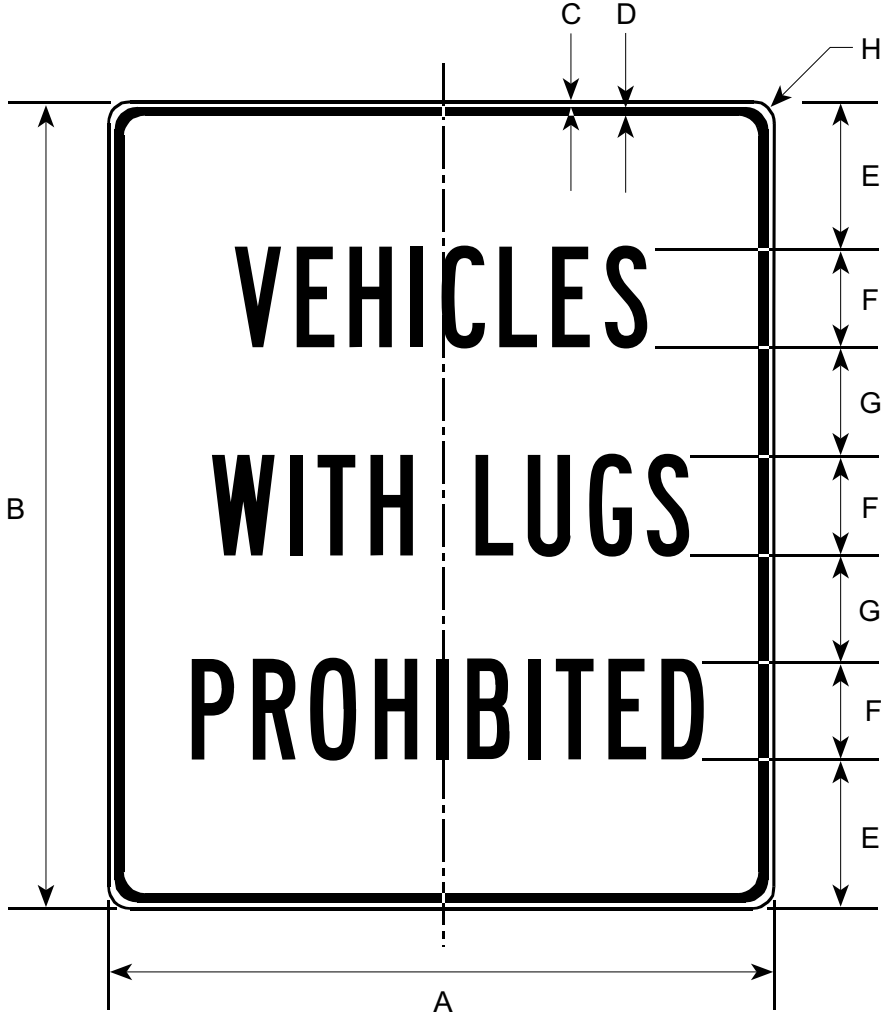

Border and Legend: Black
 Background: White

Road Class	Dimensions (inches)							
	A	B	C	D	E	F	G	H
Conv & Min	24	30	0.38	0.63	5.0	4B	4.0	1.50
Expressway	36	48	0.63	0.88	8.5	6B	6.5	2.25
Freeway	48	60	0.75	1.25	10.0	8B	8.0	3.00

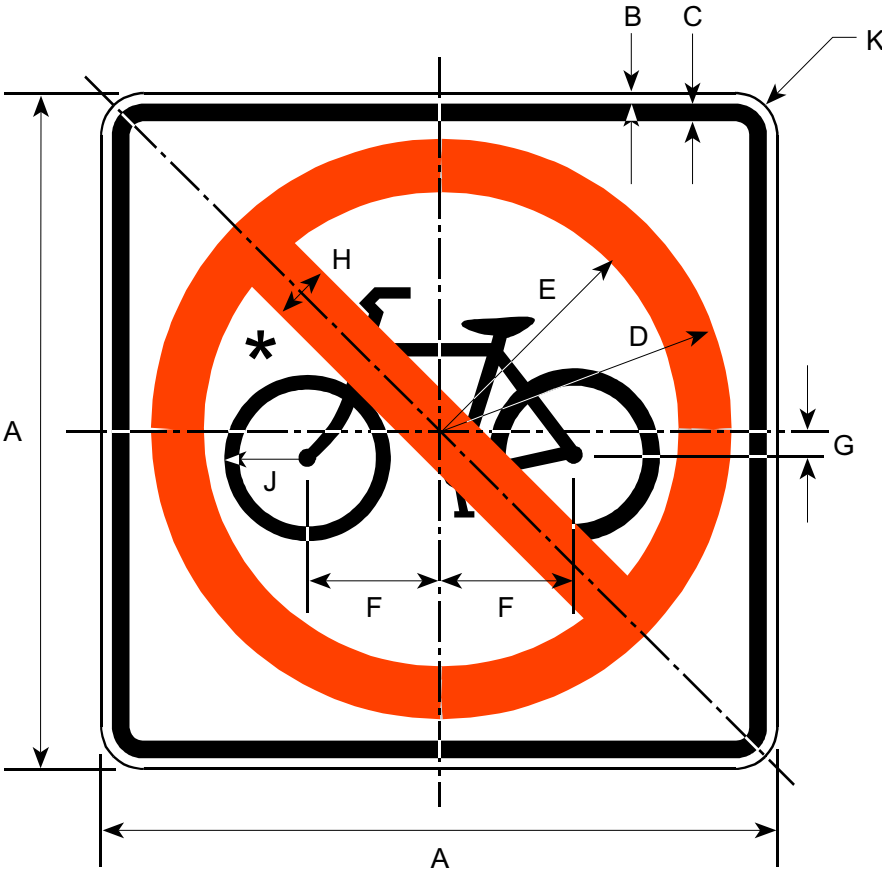

Circle & Diagonal: Red
 Border and Symbol: Black
 Background: White

* Make symbol proportional to the graphic shown

Road Class	Dimensions (inches)									
	A	B	C	D	E	F	G	H	J	K
Minimum	24	0.38	0.63	10.5	8.5	4.75	0.75	2.0	3.0	1.5
Conventional	30	0.50	0.75	13.13	10.63	5.88	0.88	2.5	3.75	1.88
Expressway	36	0.63	0.88	15.75	12.75	7.13	1.13	3.0	4.5	2.25
Freeway	48	0.75	1.25	21	17	9.5	1.5	4.0	6.0	3.0



Border and Legend: Black
Background: White

Road Class	Dimensions (inches)											
	A	B	C	D	E	F	G	H	J	K	L	M
Conv.	30	24	0.5	0.75	4.25	3.5B	2.5	3.5D	12.45	8.94	12.73	1.88
Expy.	42	24	0.63	0.88	3.5	4B	2.5	4D	14.22	10.22	14.55	2.25
Fwy.	48	30	0.75	1.25	4	5B	3.5	5D	17.77	12.77	18.18	3

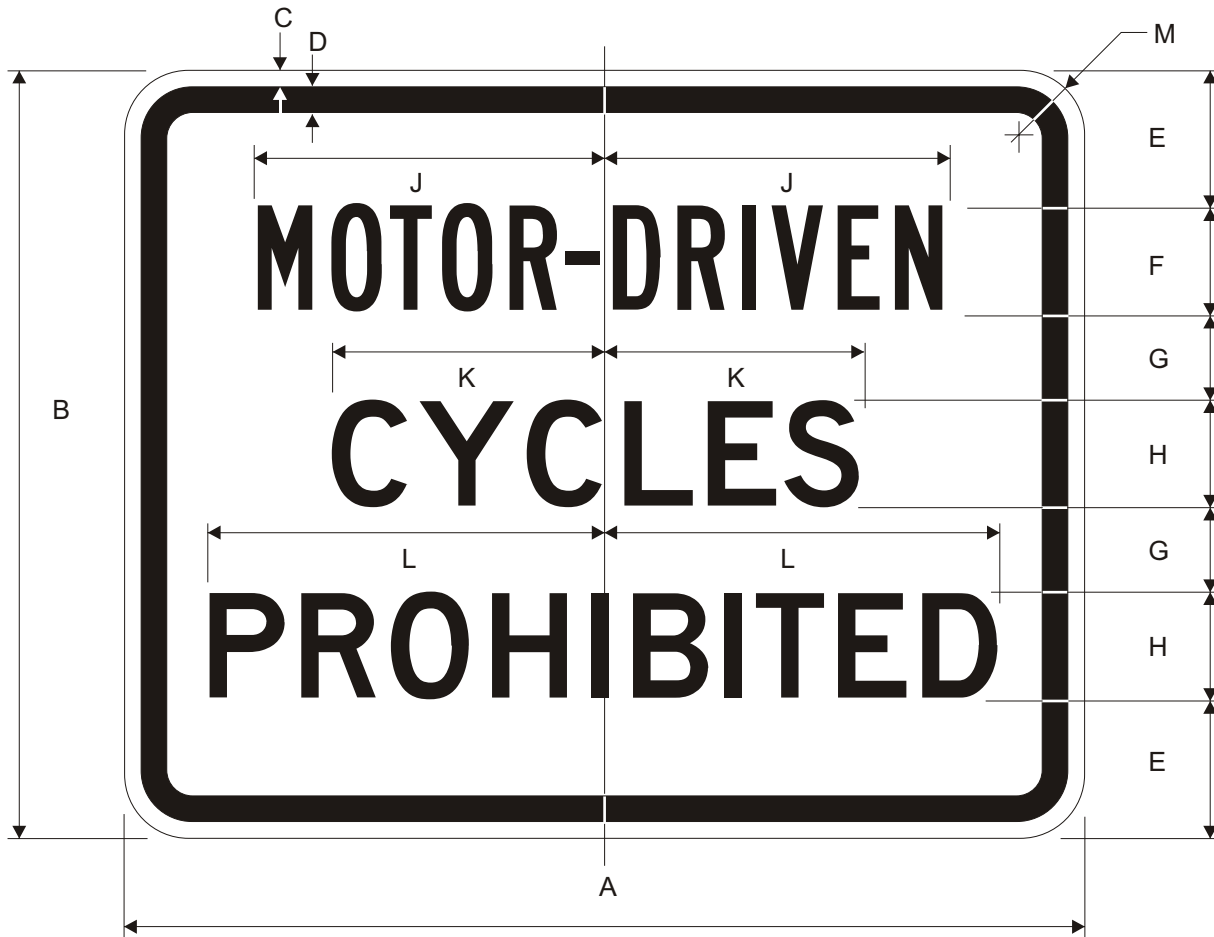

Border and Legend: Black
Background: White

Road Class	Dimensions (inches)											
	A	B	C	D	E	F	G	H	J	K	L	M
Conv.	30	24	0.5	0.75	4.25	3.5B	2.5	3.5D	11.19	8.56	12.73	1.88
Expy.	42	24	0.625	0.88	3.5	4B	2.5	4D	9.78	14.55	14.55	2.25
Fwy.	48	30	0.75	1.25	4	5B	3.5	5D	15.99	12.23	18.18	3

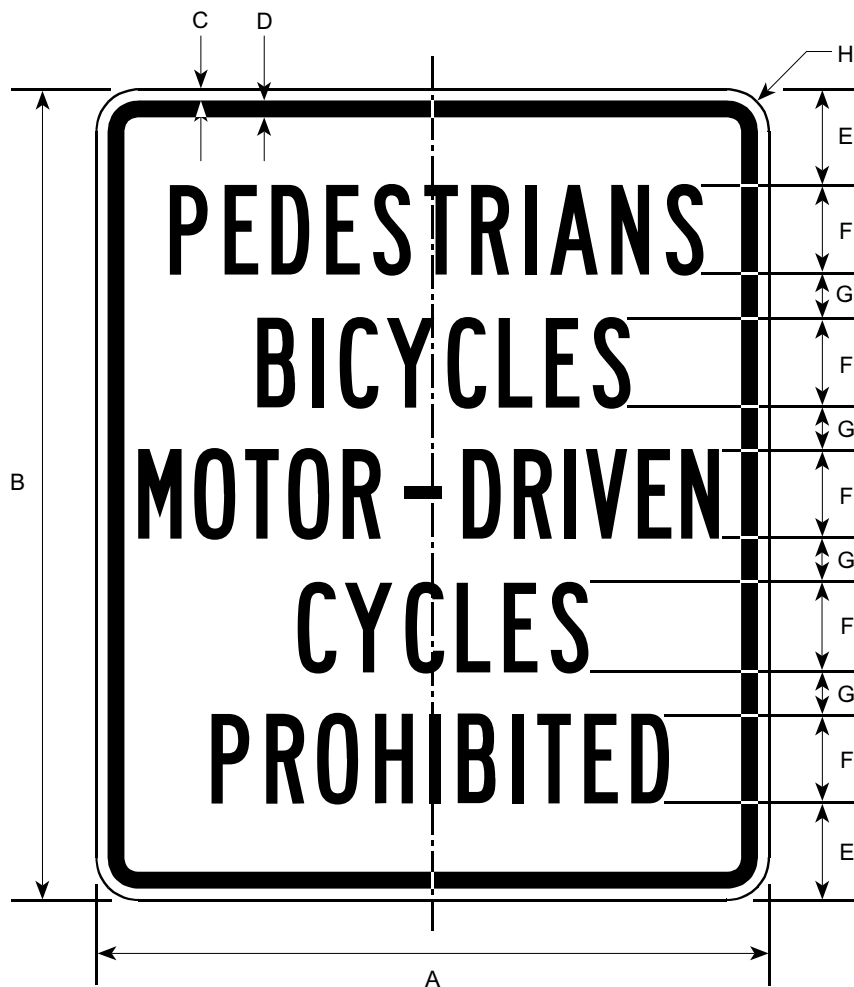

Border and Legend: Black
Background: White

Road Class	Dimensions (inches)							
	A	B	C	D	E	F	G	H
Conv & Min	30	36	0.50	0.75	4	4B	2	1.88

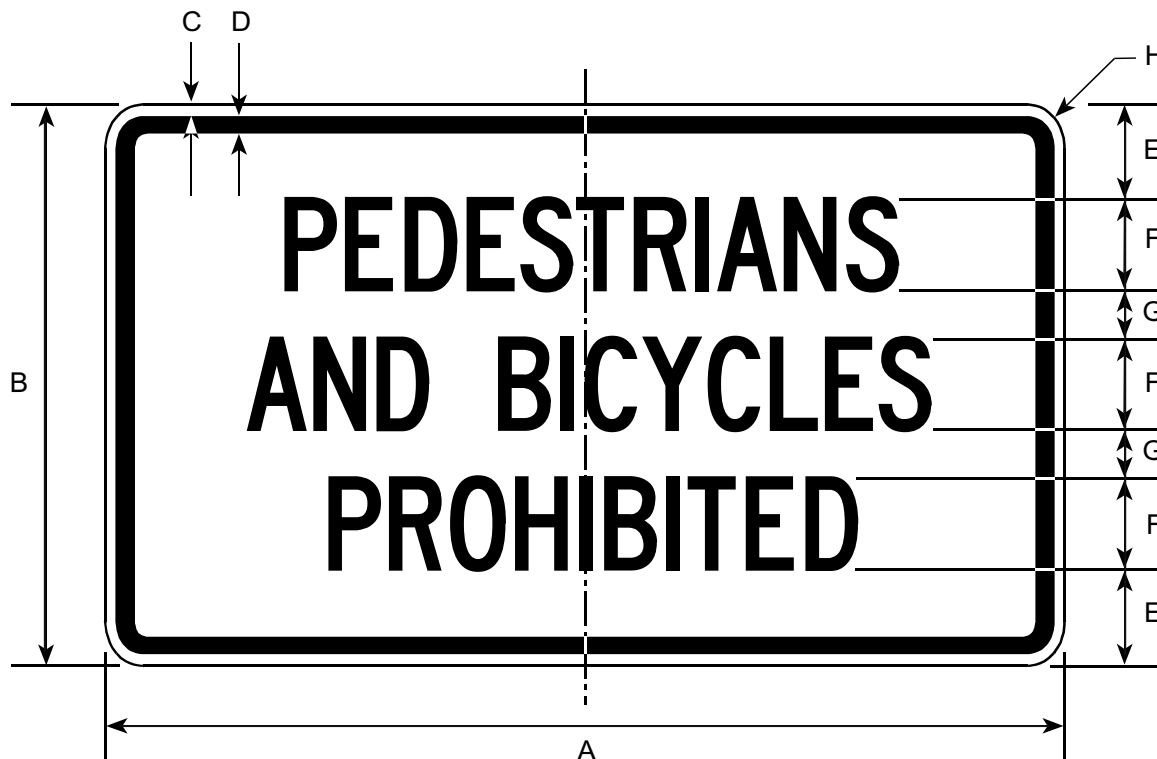

Border and Legend: Black
 Background: White

Road Class	Dimensions (inches)							
	A	B	C	D	E	F	G	H
Conv & Min	30	18	0.38	0.63	3	3C	1.50	1.50



Border and Legend: Black
 Background: White

Road Class	Dimensions (inches)							
	A	B	C	D	E	F	G	H
Conv & Min	24	12	0.38	0.63	2.25	3C	1.50	1.50

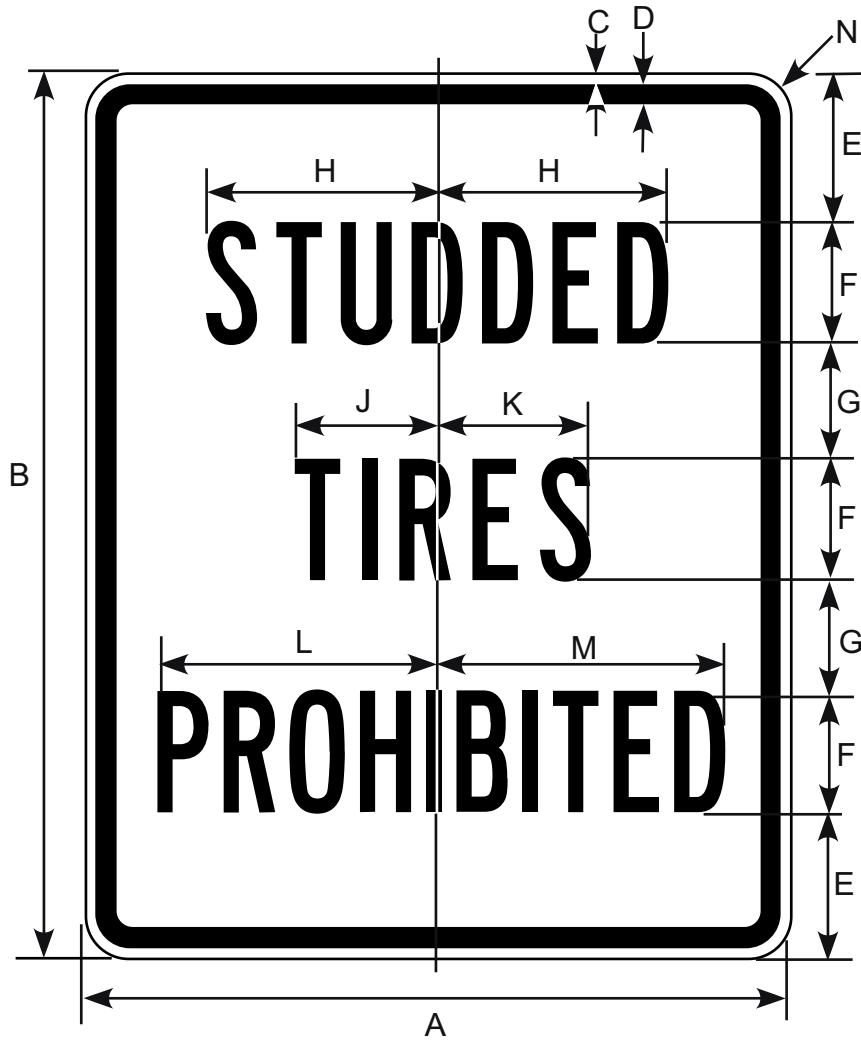

Border and Legend: Black
Background: White

Prior to the 2002 publication of this manual, this sign was numbered R5-5A.

Road Class	Dimensions (inches)												
	A	B	C	D	E	F	G	H	J	K	L	M	N
Minimum	18	24	0.38	0.63	4.25	3B	3.25	6.75	3.63	3.56	7.13	7.25	1.5
Conventional	24	30	0.38	0.63	5.0	4B	4.0	7.75	4.88	4.75	9.5	9.63	1.5
Expressway	36	48	0.63	0.88	8.5	6B	6.5	11.63	7.31	7.13	14.25	14.5	2.25
Freeway	48	60	0.75	1.25	10	8B	8.0	15.5	9.75	9.5	19	19.38	3.0

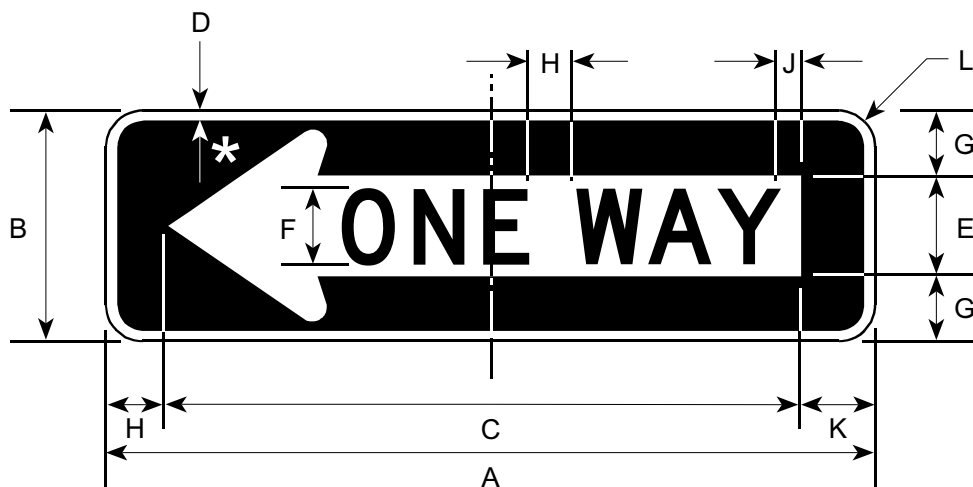

R6-1L

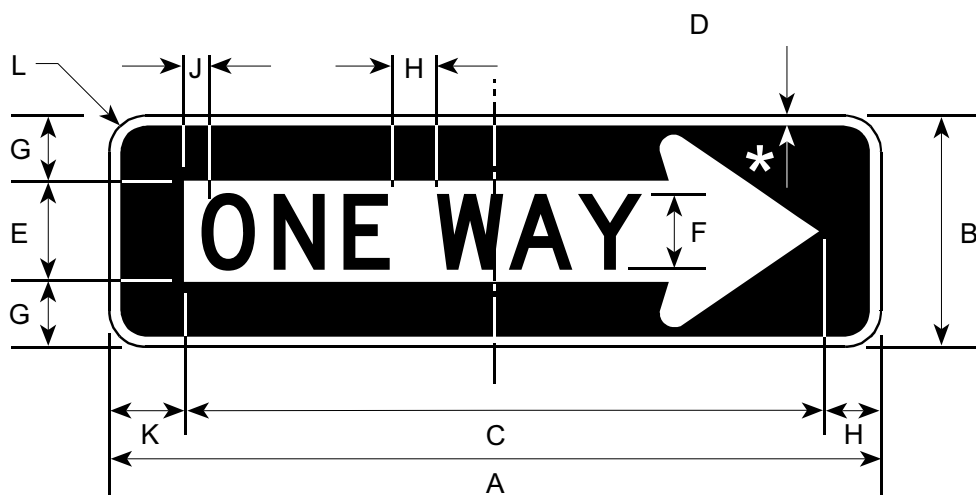

R6-1R

Border and Arrow: White
 Legend and Background: Black

*See Appendix B-1 for Standard Arrow Details.

Road Class	Dimensions (inches)										
	A	B	C	D	E	F	G	H	J	K	L
Conv & Min	36	12	31	0.50	5.24	4D	3.38	2.0	1.25	3.0	1.5
Expwy, Fwy	48	16	41.31	0.63	7.0	5D	4.5	3.0	2.0	3.69	2.0



R6-2R



R6-2L

Border and Legend: Black
Background: White

*See Appendix B-1 for Standard Arrow Details.

Road Class	Dimensions (inches)												
	A	B	C	D	E	F	G	H	J	K	L	M	N
Minimum	18	24	0.38	0.63	2.5	5D	1.5	4.50	5.5	2.25	6.0	5.88	1.5
Conventional	24	30	0.38	0.63	3.0	6D	1.88	6.06	7.06	3.0	8.0	7.75	1.5

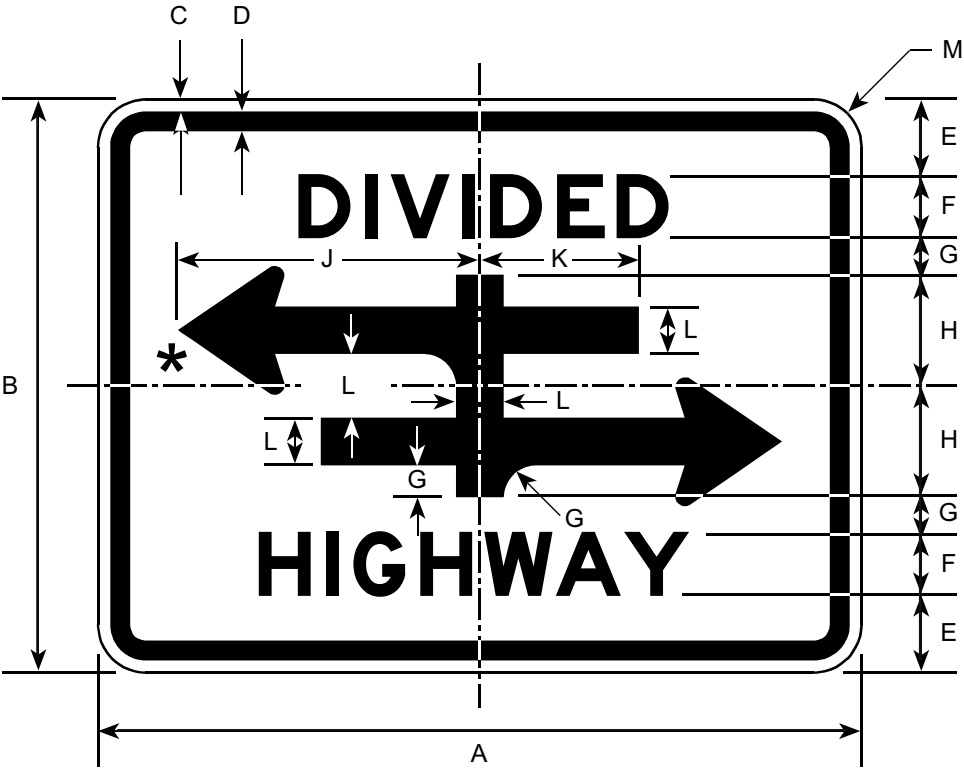

Border and Legend: Black
 Background: White

*See Appendix B-1 for Standard Arrow Details.

Road Class	Dimensions (inches)											
	A	B	C	D	E	F	G	H	J	K	L	M
Conv & Min	24	18	0.38	0.63	2.5	2E	1.0	3.5	9.5	5.0	2.0	1.5

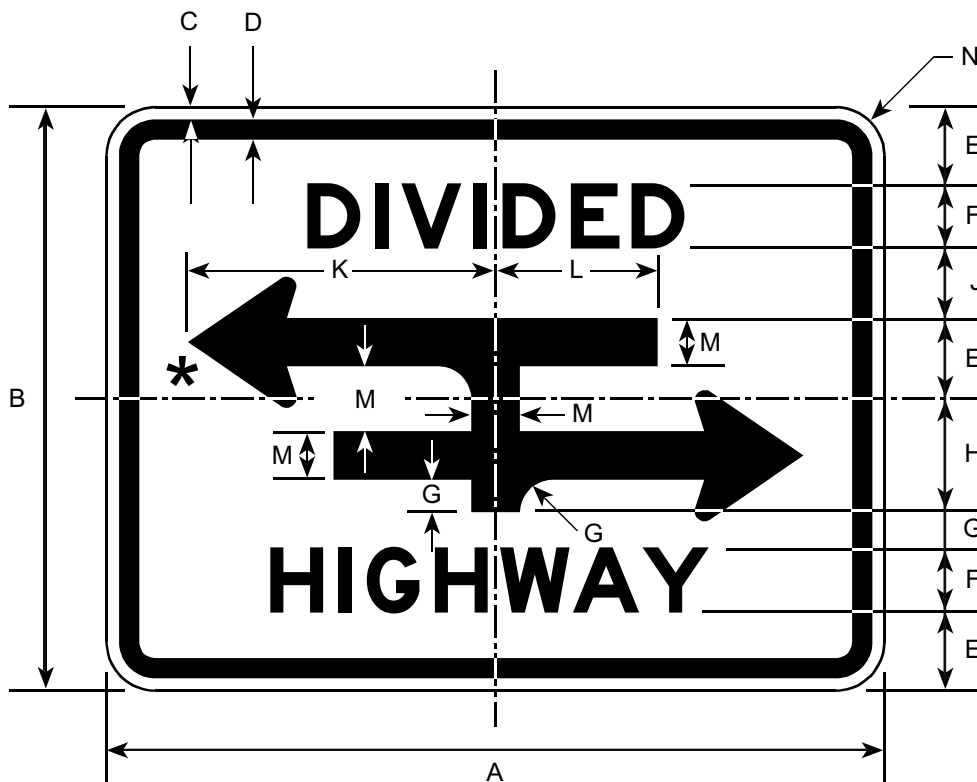

Border and Legend: Black
Background: White

*See Appendix B-1 for Standard Arrow Details.

Road Class	Dimensions (inches)												
	A	B	C	D	E	F	G	H	J	K	L	M	N
Conv & Min	24	18	0.38	0.63	2.5	2E	1.0	3.5	2.0	9.5	5.0	2.0	1.5

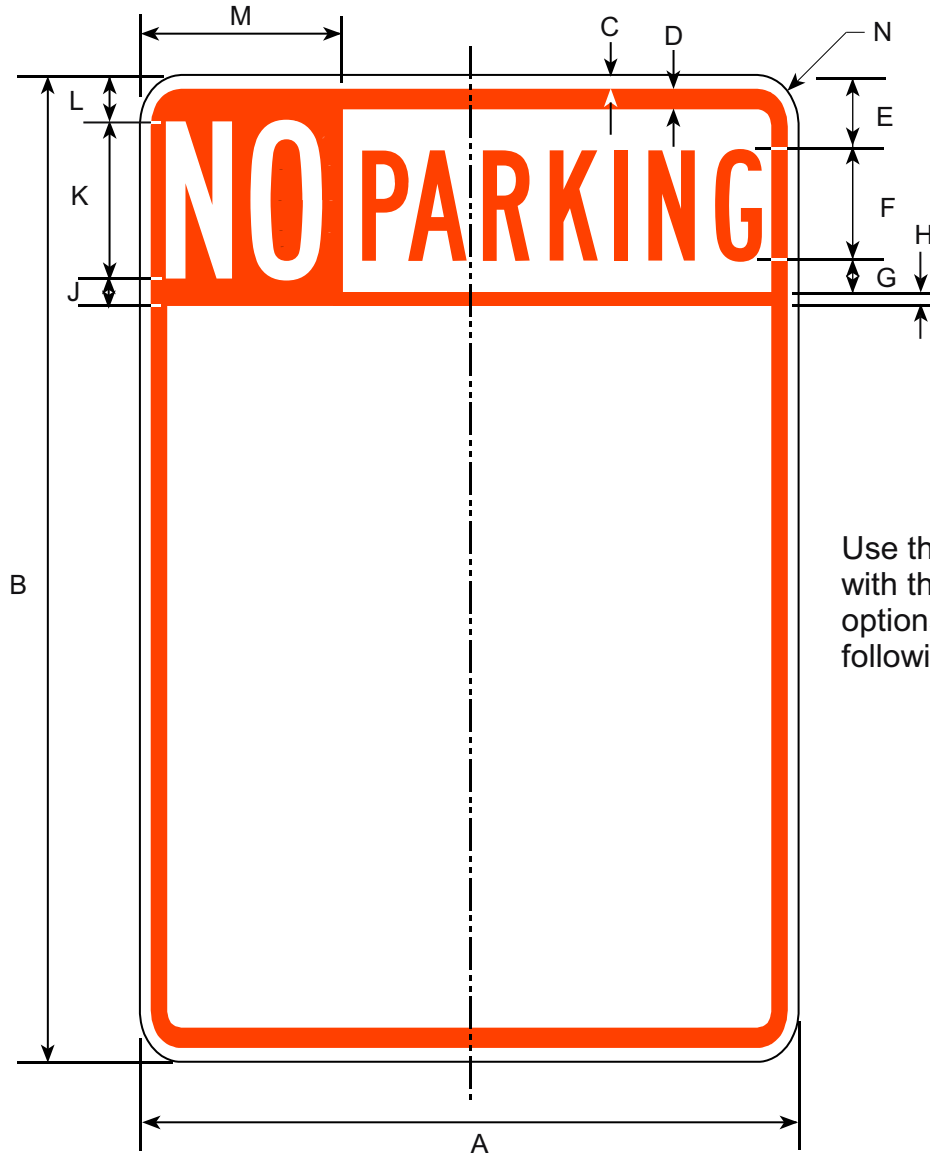

Use this template with the legend options on the following pages

Top Left
Legend: White
Background: Red

Top Right & Bottom
Legend: Red
Background: White

Prior to the 2002 publication of this manual, this sign was numbered R7-.

Road Class	Dimensions (inches)												
	A	B	C	D	E	F	G	H	J	K	L	M	N
Conv & Min	12	18	0.38	0.38	2	2B	1.25	0.25	1.06	3C	1.44	4	1.5

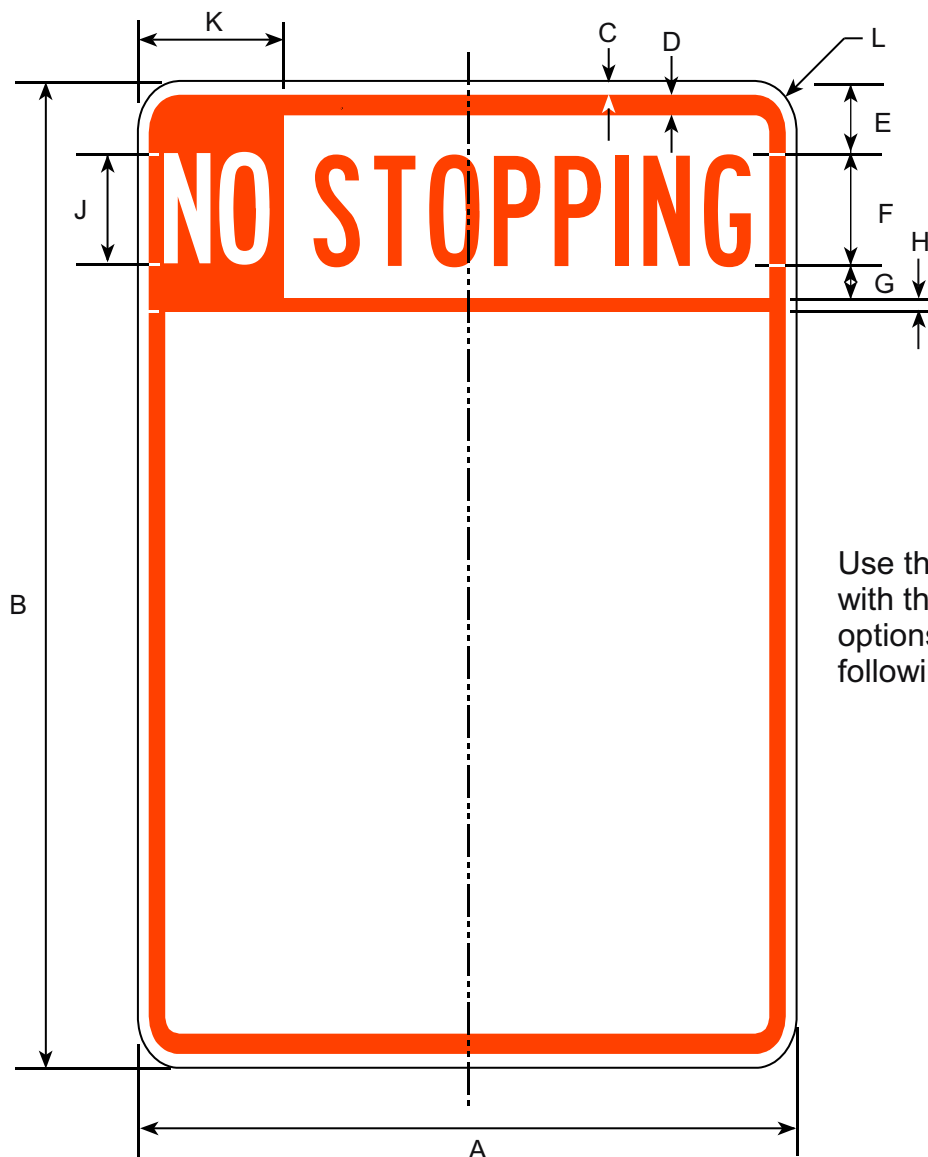

Use this template with the legend options on the following pages

Top Left
Legend: White
Background: Red

Top Right & Bottom
Legend: Red
Background: White

Road Class	Dimensions (inches)										
	A	B	C	D	E	F	G	H	J	K	L
Conv & Mir	12	18	0.38	0.38	2	2B	1.25	0.25	2B	2.5	1.5

Legend Options for R7S & R7P

(1 of 4)

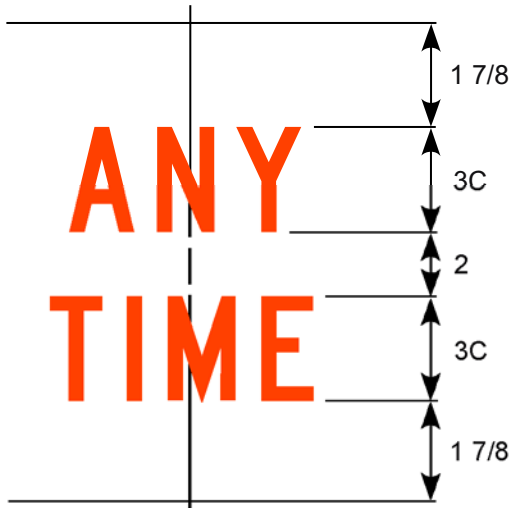

-101

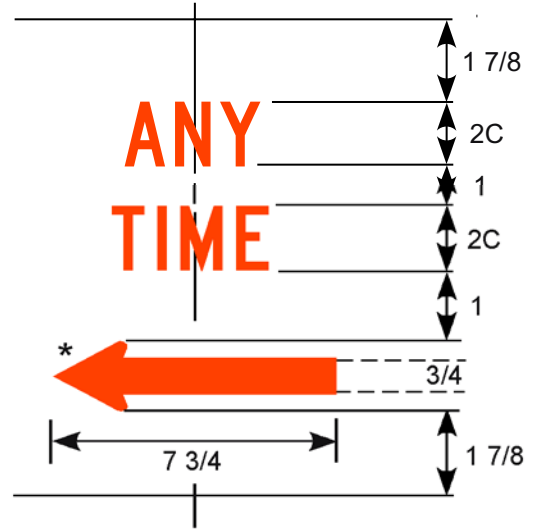

-101L

Reverse arrow for -101R

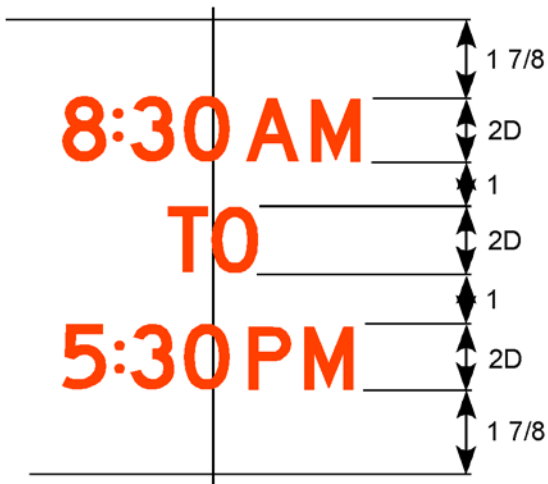

-102

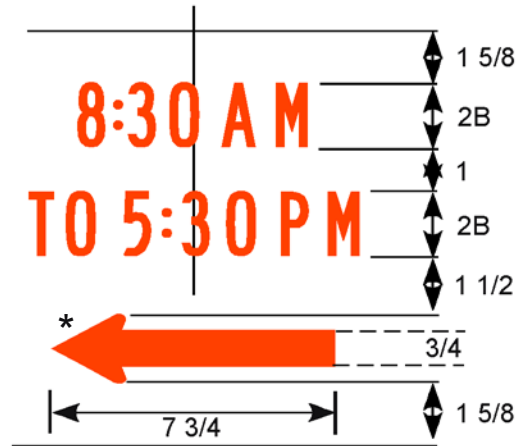

-102L

Reverse arrow for -101L

Legend: Red
Background: White

* See Appendix B-1 for arrow details.

Legend Options for R7S & R7P

(2 of 4)

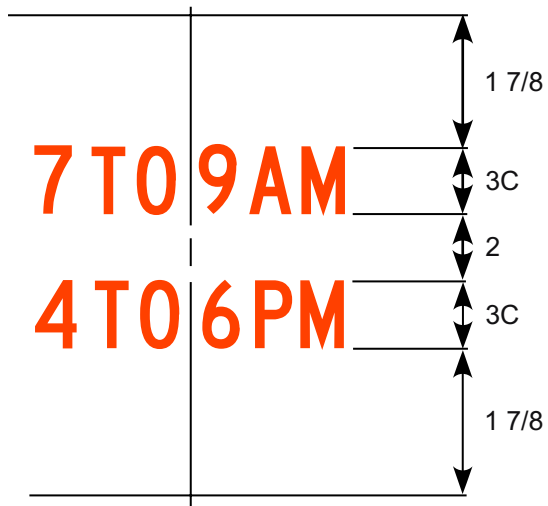

-102A

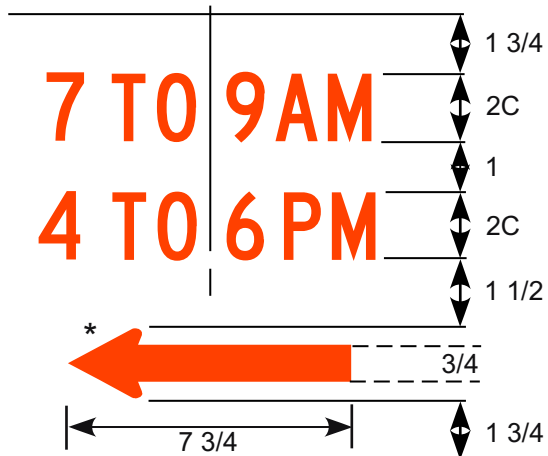

-102AL

Reverse arrow for -102AR

Legend: Red
Background: White

* See Appendix B-1 for standard arrow details.



-103

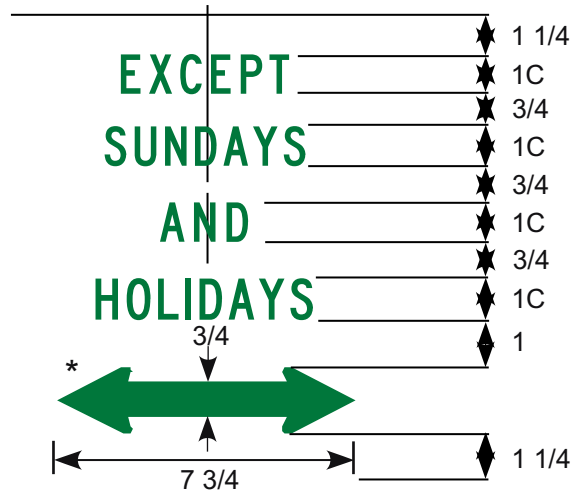

-103RL

Legend: Green
Background: White

* See Appendix B-1 for standard arrow details.

Legend Options for R7S & R7P

(3 of 4)

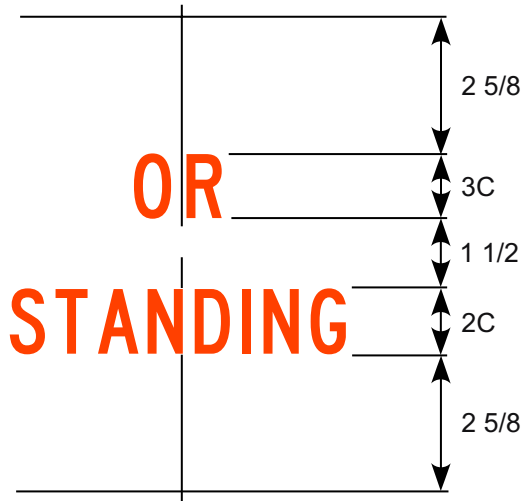

-104

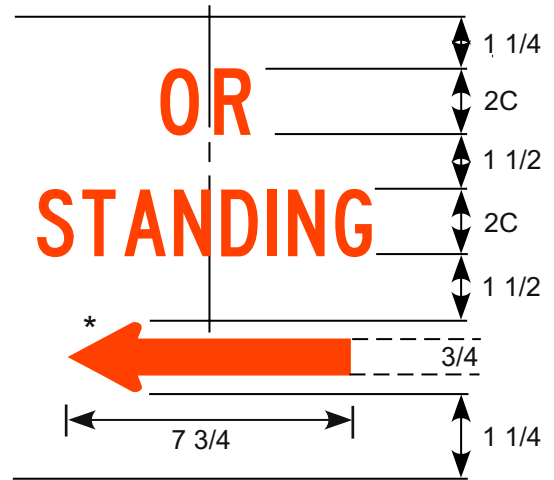

-104L

Reverse arrow for -104R

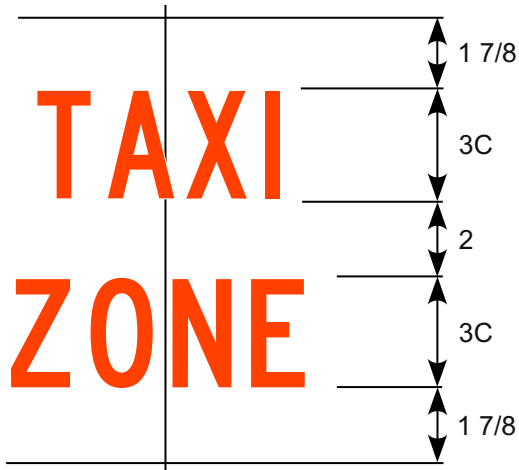

-105

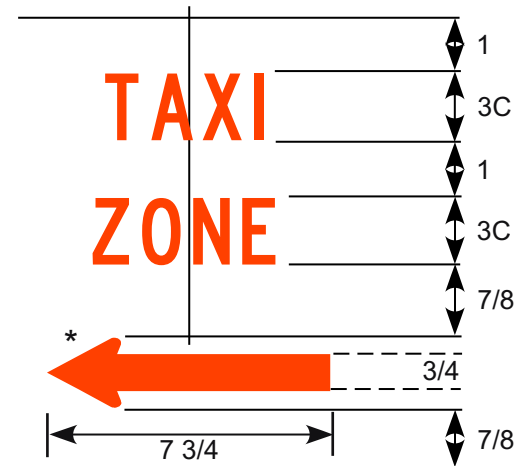

-105L

Reverse arrow for -105R

Legend: Red
Background: White

* See Appendix B-1 for arrow details.

Legend Options for R7S & R7P

(4 of 4)

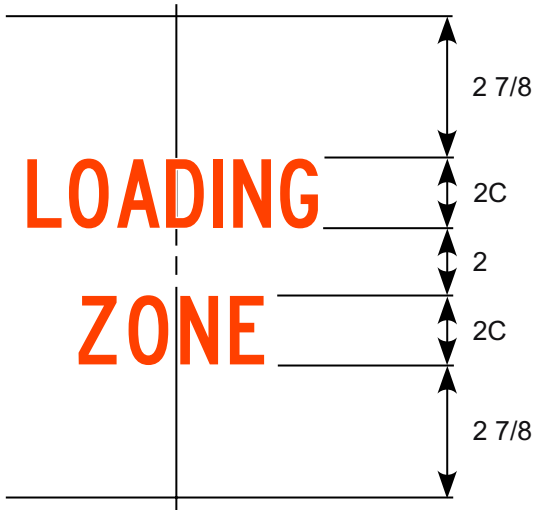

-106

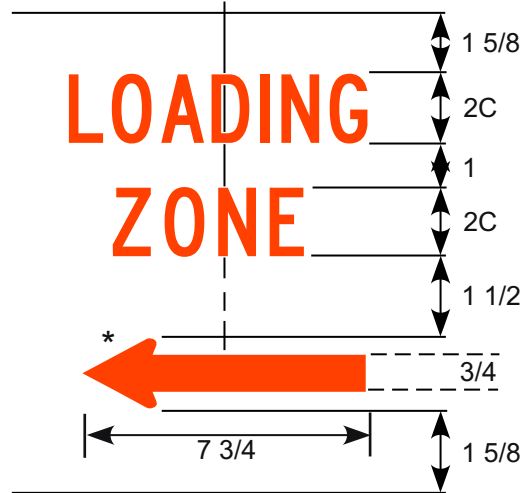

-106L

Reverse arrow for -106R

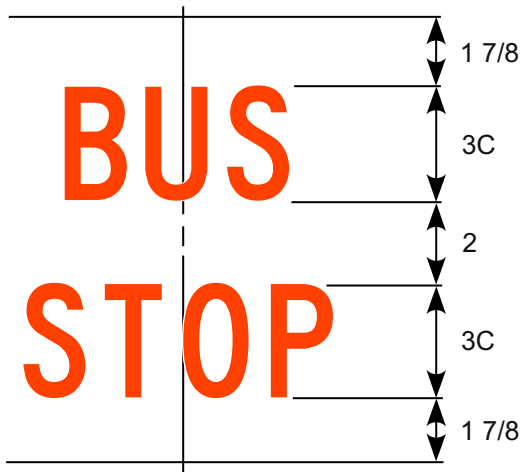

-107

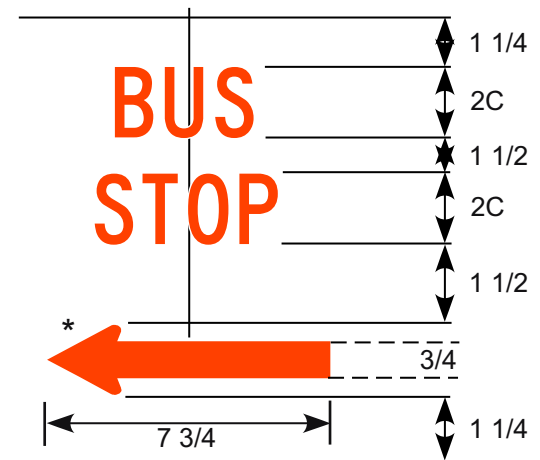

-107L

Reverse arrow for -107R

Legend: Red
Background: White

* See Appendix B-1 for arrow details.



R7-8RL

Border, Arrow, and Legend: Green
 White Symbol on Blue Background
 Background: White

- * Make the symbol proportional to the one shown.
- ** See Appendix B-1 for standard arrow details.

Code	Arrow Options:
R7-8	No Arrow
R7-8L	Left
R7-8R	Right
R7-8RL	Right and Left

Road Class	Dimensions (inches)												
	A	B	C	D	E	F	G	H	J	K	L	M	N
Conv & Min	12	18	0.38	0.63	2C	1.5	1.0	2.5	7.75	6.0	1.75	0.75	1.5

R7-8A

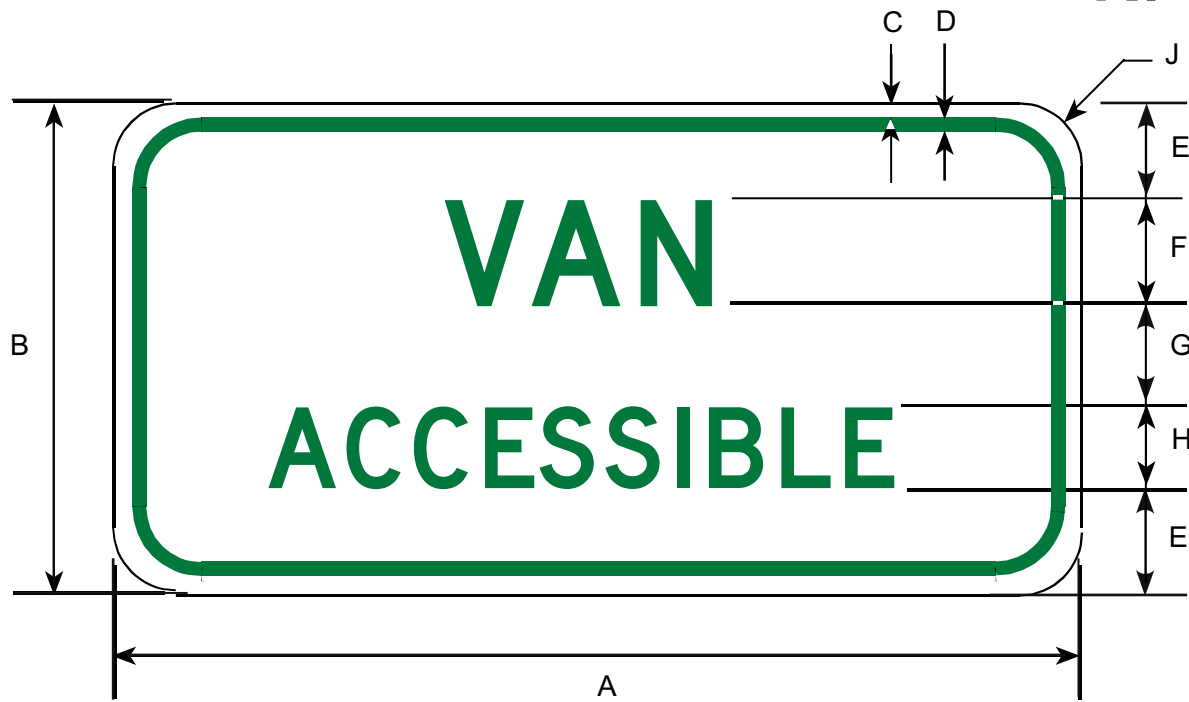

PARKING APPLICATION
 Border and Legend: Green or Black
 Background: White



DESTINATION APPLICATION
 Border and Legend: White
 Background: Blue

Road Class	Dimensions (inches)								
	A	B	C	D	E	F	G	H	J
Minimum	12	6	0.38	0.44	1.50	1.5D	0.5	1.0D	1.5
Conventional	18	9	0.38	0.44	2.25	2.0D	1.0	1.5D	1.5

R7-9A



Symbol: Black
Background: White
Legend, Circle, Diagonal, and Border: Red

R7-107A

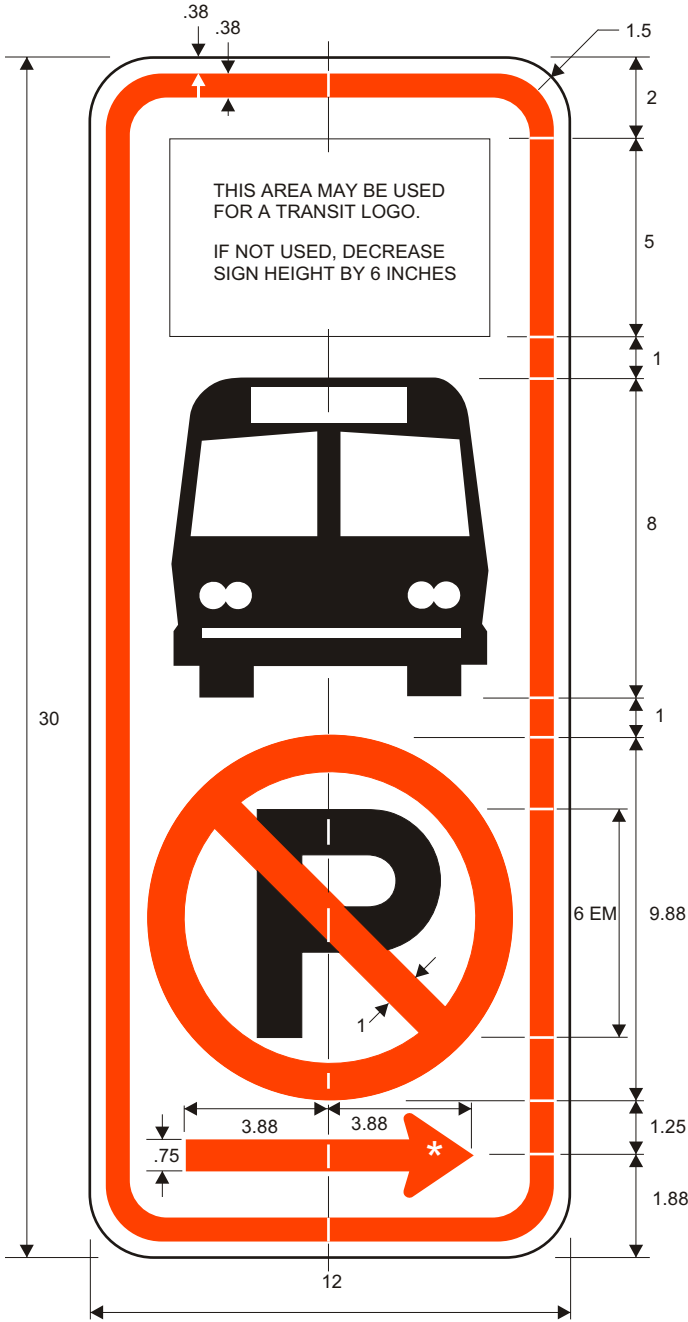

Legend, Circle, Arrow and Diagonal: Red
Symbols and Logo: Black
Background: White

*See Appendix B-1 for Standard Arrow Details.

R7-108

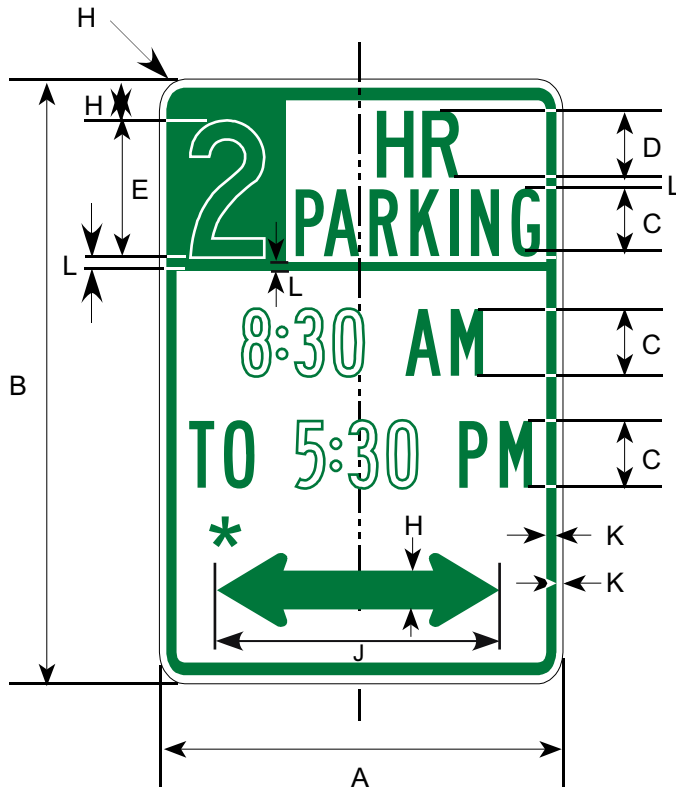

R7-108

Top Left
Legend: White
Background: Green



R7-108A



R7-108B

Top Right & Bottom
Legend: Green
Background: White

Prior to the 2002 publication of this manual, this sign was numbered R7-108B.

*See Appendix B-1 for Standard Arrow Details.

Time is variable

Road Class	Dimensions (inches)										
	A	B	C	D	E	F	G	H	J	K	L
Conv & Min	12	18	2B	2C	4C	3B	2D	0.75	7.75	0.38	0.25

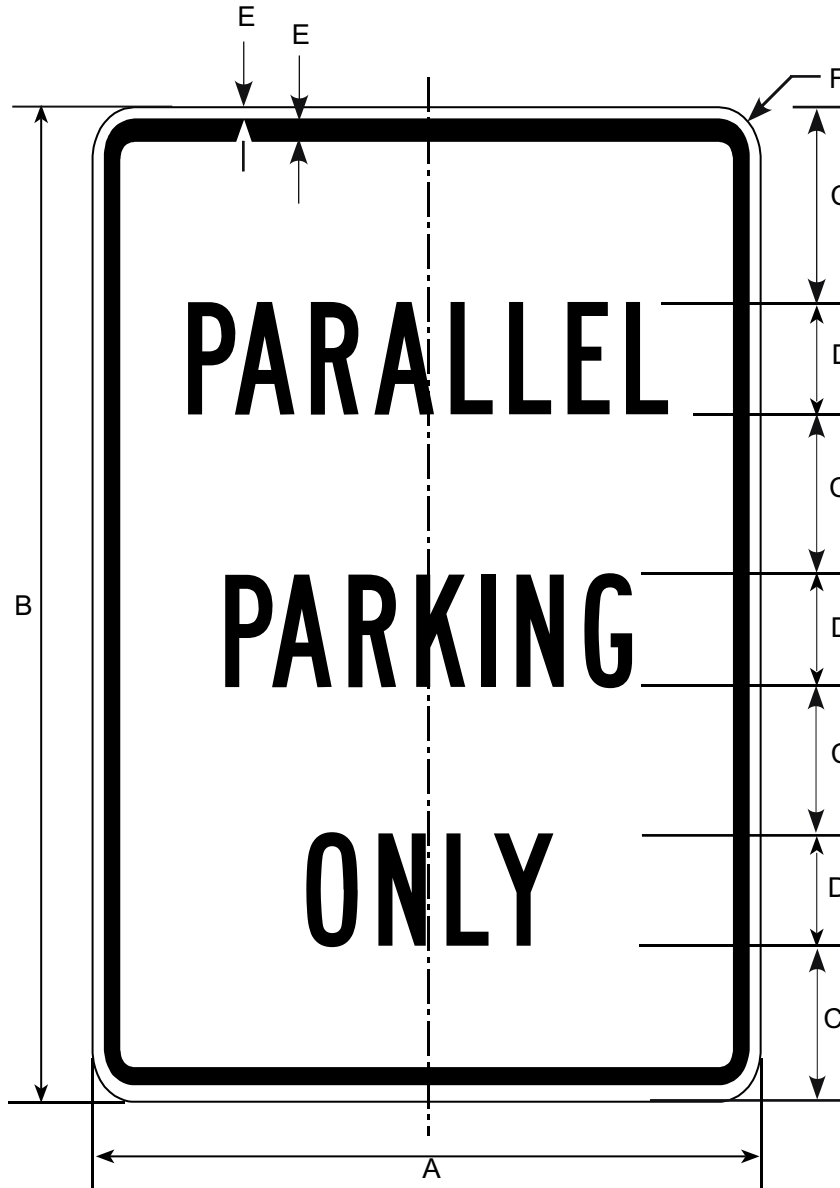

Border and Legend: Black
Background: White

Road Class	Dimensions (inches)					
	A	B	C	D	E	F
Conv & Min	12	18	3	2B	0.38	1.5

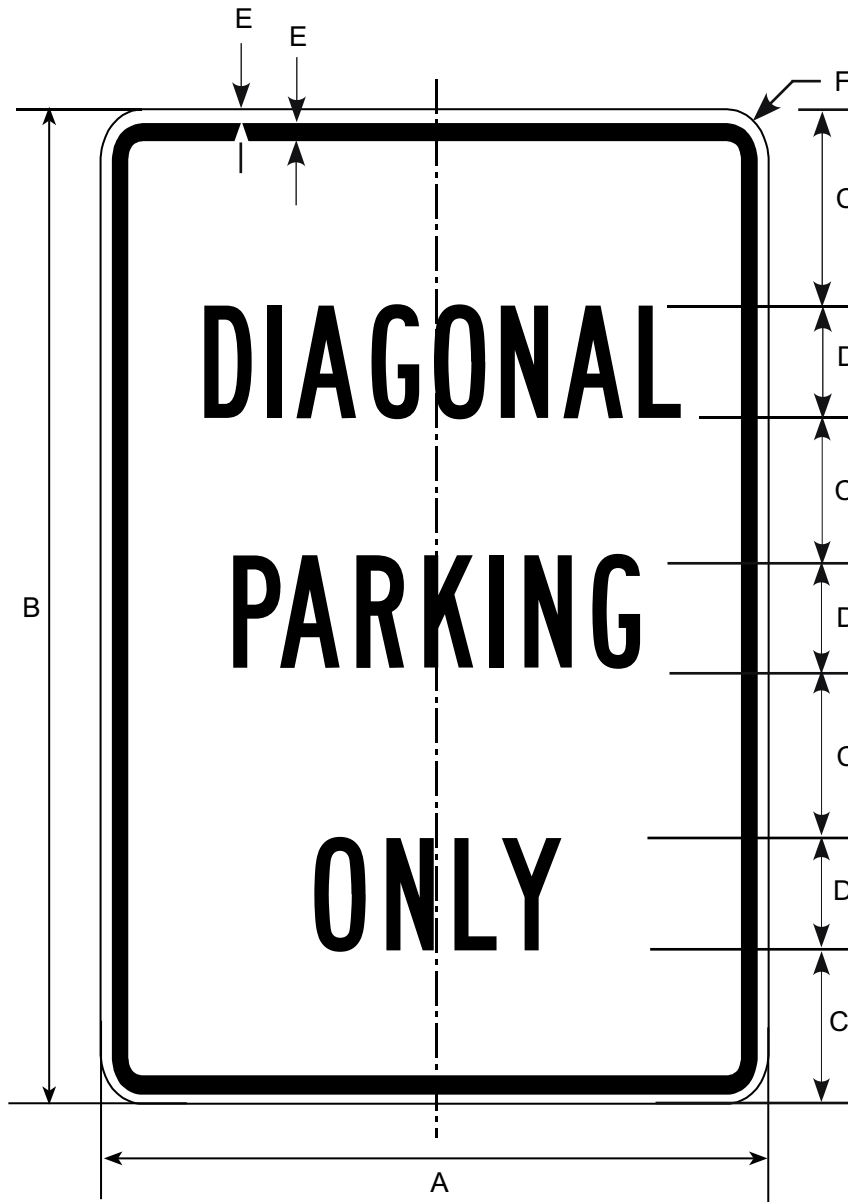

Border and Legend: Black
Background: White

Road Class	Dimensions (inches)					
	A	B	C	D	E	F
Conv & Mii	12	18	3	2B	0.38	1.0



*See Appendix B-1 for Standard Arrow Details.

Border and Legend: Red
Background: White

Border: Red
Legend: Green
Background: White

R7-201
R7-201A
R7-201B

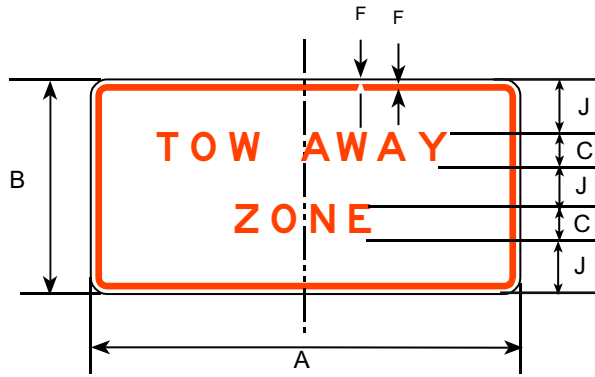

R7-201

Border and Legend: Red
 Background: White

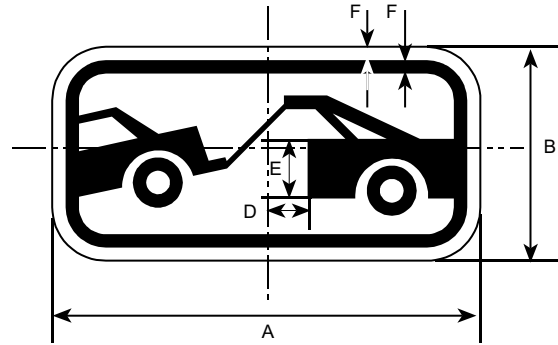

R7-201A

Border and Legend: Black
 Background: White

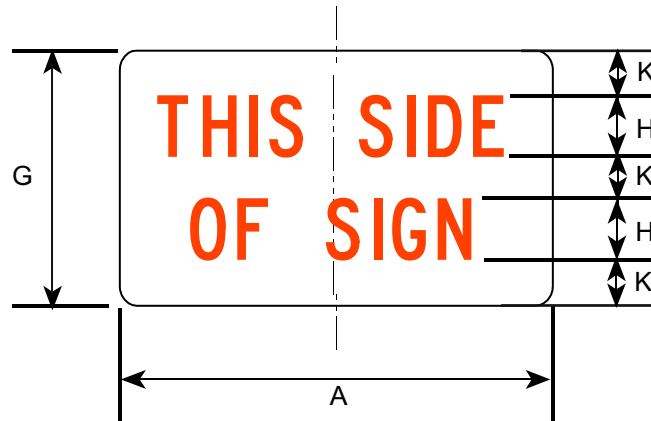

R7-201B

Legend: Red
 Background: White

Prior to the 2002 publication of this manual, this sign was numbered R7-201, R7-201A, R7-202.

Road Class	Dimensions (inches)									
	A	B	C	D	E	F	G	H	J	K
Conv & Min	12	6.0	1E	1.13	1.25	0.38	6.5	2C	1.33	0.67

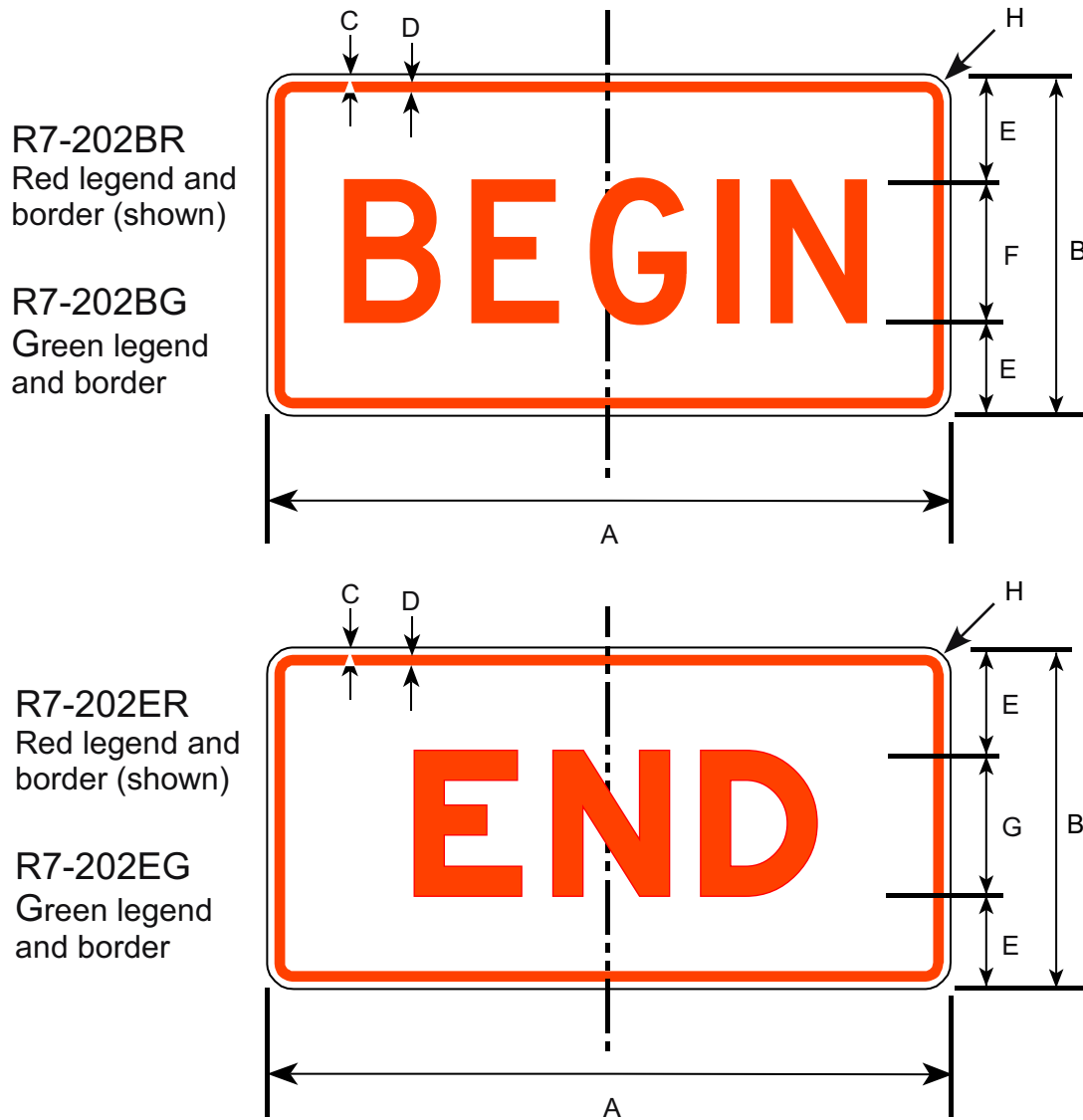

Border and Legend: Should match color of primary sign it is used with.
Background: White

Prior to the 2002 publication of this manual, this sign was numbered R7-202K&M.

Road Class	Dimensions (inches)							
	A	B	C	D	E	F	G	H
Minimum	12	6	0.38	0.38	2.00	2E	2E	1.50
Conventional	24	12	0.38	0.63	3.5	5D	5E	1.50
Expwy, Fwy	36	18	0.38	0.63	5.5	7E	7E	1.88

R7-203



TOP: Legend: White
Background: Red

BOTTOM: Border and Legend: Red
Background: White

Road Class	Dimensions (inches)											
	A	B	C	D	E	F	G	H	J	K	L	M
Conv.	18	24	0.38	0.63	9.81	2.25	2D	1.75	3.5	2C	3	7.69
Oversized	24	30	0.38	0.63	12	2.75	2.5D	2.25	4.81	2.5C	3.19	9.59

N	P	Q	R	S
7.95	6.56	4.18	5.06	1.5
10.09	8.2	5.23	6.32	1.5

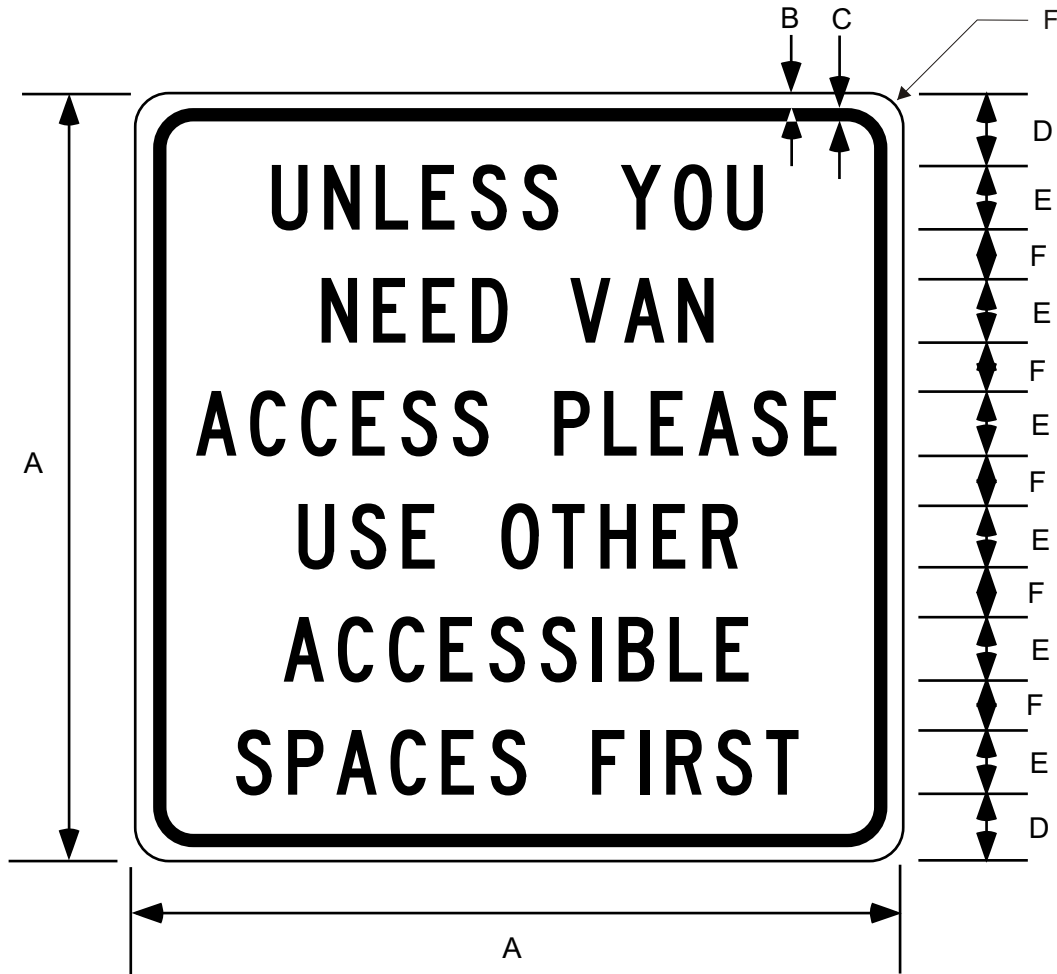

Border and Legend: Black
Background: White

Road Class	Dimensions (inches)					
	A	B	C	D	E	F
Conv & Min	12	0.38	0.38	1.13	1.0C	0.75



Border and Legend: Red
Background: White

Road Class	Dimensions (inches)										
	A	B	C	D	E	F	G	H	J	K	L
Minimum	18	24	0.38	0.63	3.50	3D	2.5	3C	2D	2.0	1.5
Conventional	24	30	0.38	0.63	3.63	5D	2.25	5C	3D	2.25	1.5
Expressway	36	48	0.63	0.88	6.0	7D	4.67	7C	4D	4.0	2.25
Freeway	48	60	0.75	1.25	7.5	9D	5.67	9C	5D	5.0	3.0

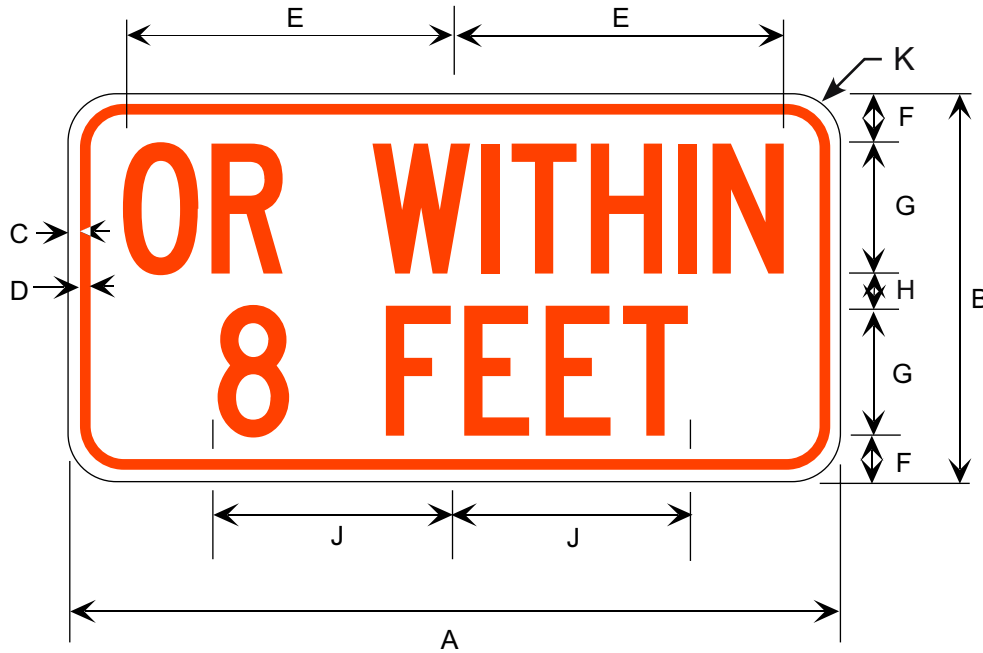

Border and Legend: Red
Background: White

Road Class	Dimensions (inches)									
	A	B	C	D	E	F	G	H	J	K
Conv & Min	24	12	0.38	0.38	10.5	1.5	4C	1	7.5	0.75

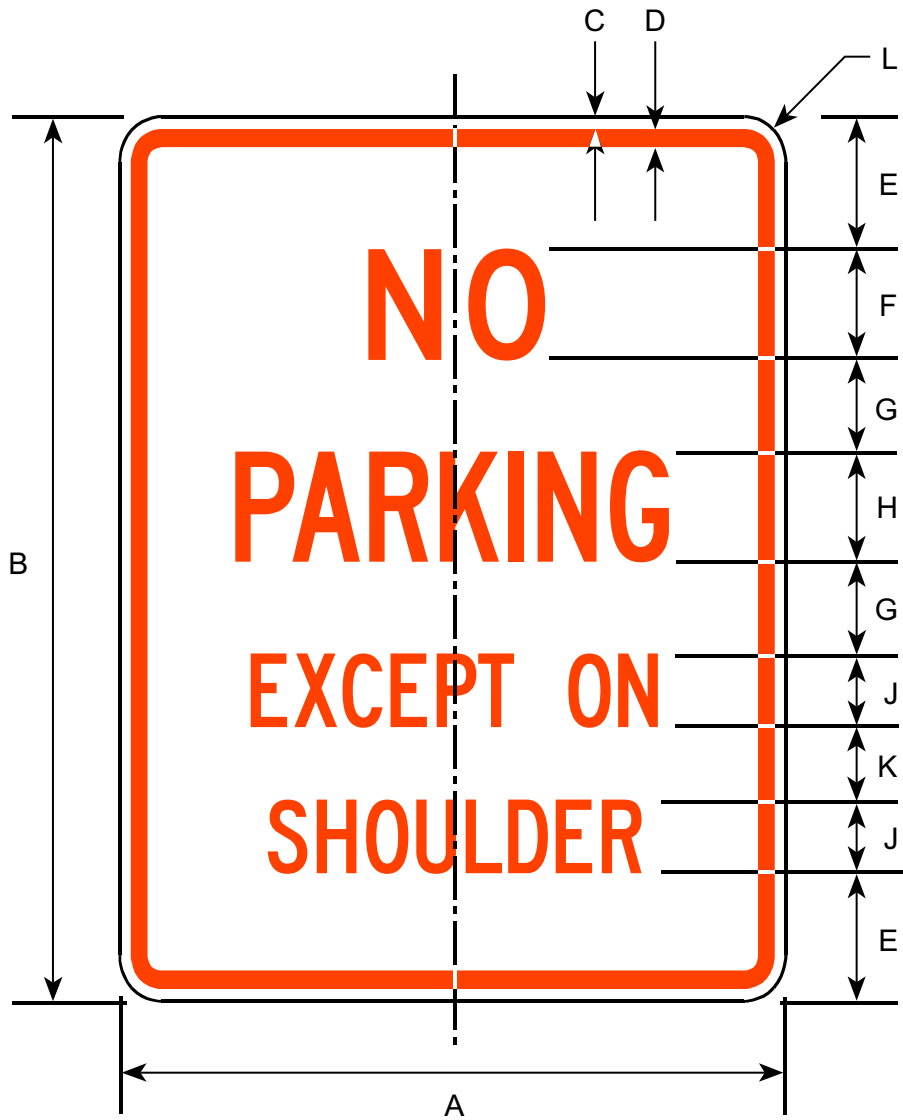

Border and Legend: Red
Background: White

Road Class	Dimensions (inches)										
	A	B	C	D	E	F	G	H	J	K	L
Minimum	18	24	0.38	0.63	3.5	3D	2.5	3C	2C	2.0	1.5
Conventional	24	30	0.38	0.63	3.63	5D	2.25	5C	3C	2.25	1.5
Expressway	36	48	0.63	0.88	6.0	7D	5.0	7C	4C	4.0	2.25
Freeway	48	60	0.75	1.25	7.5	9D	6.0	9C	5C	5.0	3.0

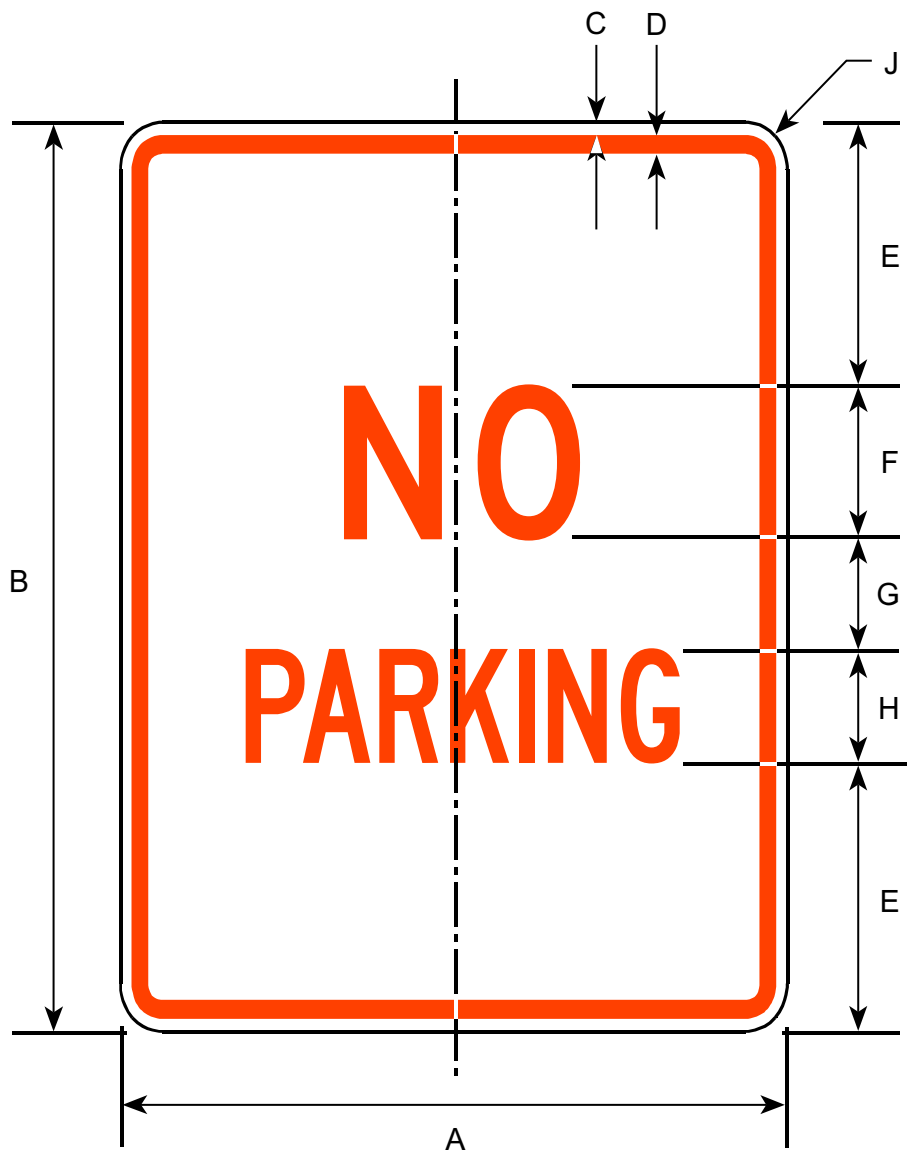

Border and Legend: Red
Background: White

Road Class	Dimensions (inches)								
	A	B	C	D	E	F	G	H	J
Minimum	18	24	0.38	0.63	7.00	4D	3.0	3C	1.50
Conventional	24	30	0.38	0.63	7.25	6D	4.5	5C	1.50
Expressway	36	48	0.63	0.88	7.50	8D	6.0	7C	2.25
Freeway	48	60	0.75	1.25	10.50	10D	8.0	9C	3.00

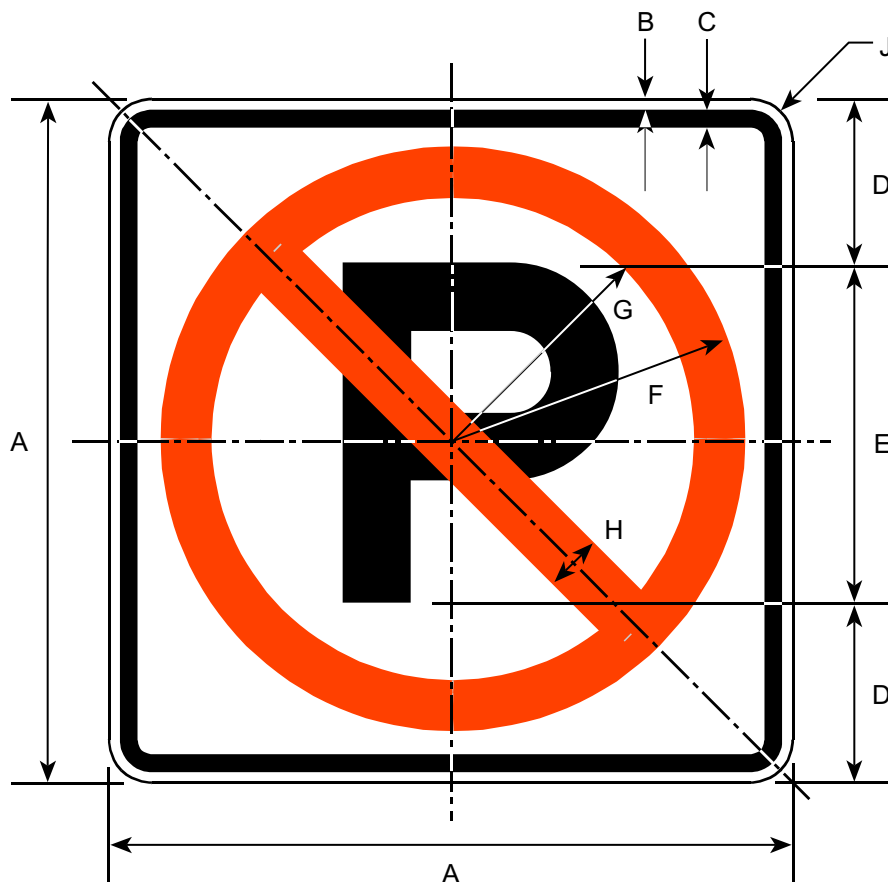

Circle & Diagonal: Red
 Symbol & Border: Black
 Background: White

Road Class	Dimensions (inches)								
	A	B	C	D	E	F	G	H	J
Minimum	18	0.38	0.38	4.5	9E(M)	4.88	3.88	1.00	1.50
Conventional	24	0.38	0.63	6	12E(M)	10.50	8.50	2.50	1.50
Expressway	36	0.63	0.88	9	18E(M)	15.75	12.75	3.00	2.25
Freeway	48	0.75	1.25	12	24E(M)	21.00	17.00	4.00	3.00

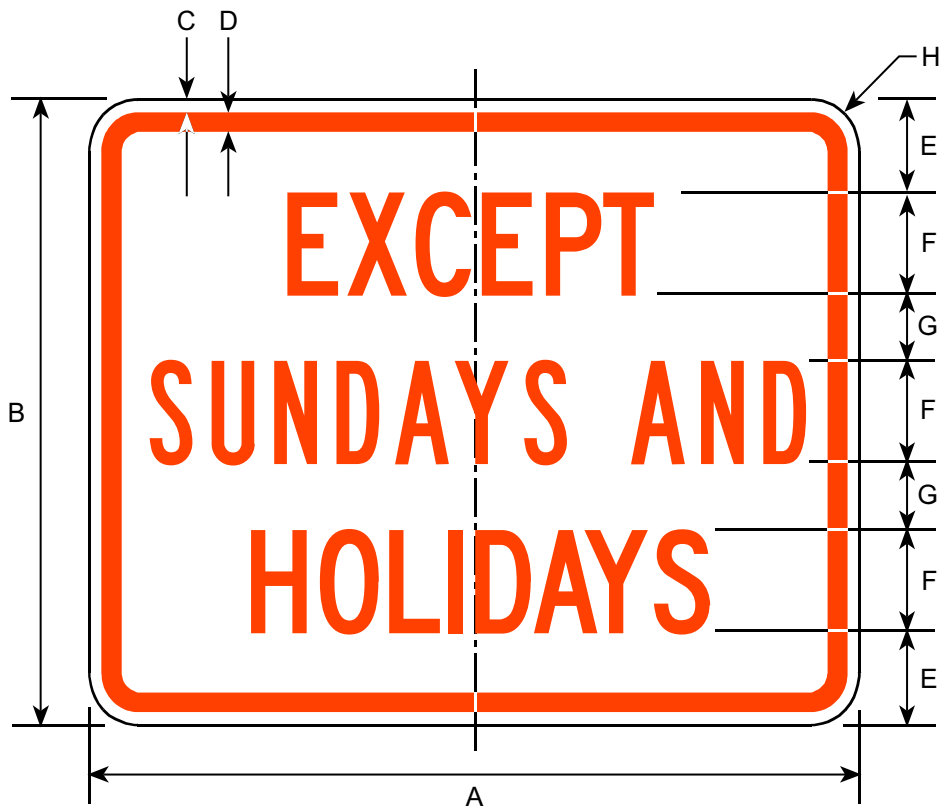

Border and Legend: Red
Background: White

OTHER TYPICAL LEGENDS

**ON
TRACKS**

**ON
BRIDGE**

**ON
PAVEMENT**

**6 AM
TO 6 PM**

**EXCEPT ON
SHOULDERS**

**LOADING
ZONE**



See drawings R7S-102L and R7S-103RL for arrow details.

Prior to the 2002 publication of this manual, this sign was numbered R8-30.

Road Class	Dimensions (inches)							
	A	B	C	D	E	F	G	H
Minimum	12	VAR	0.38	0.38	VAR	VAR	VAR	1.5
Conventional	24	VAR	0.38	0.63	VAR	VAR	VAR	1.5

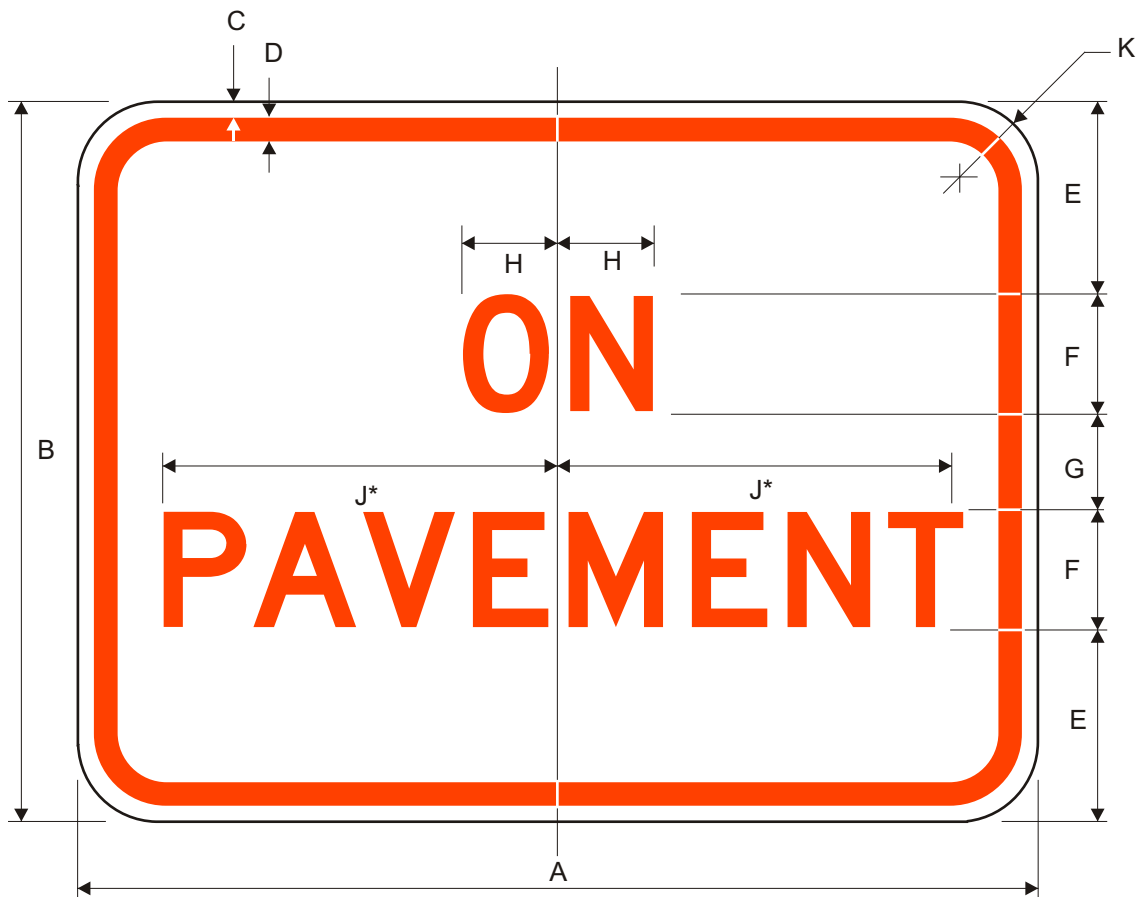

*Reduce spacing to fit for 30" size.

Border and Legend: Red
Background: White

Road Class	Dimensions (inches)									
	A	B	C	D	E	F	G	H	J	K
Minimum	18	12	0.38	0.63	3.0	2D	2.0	1.61	6.59	1.5
Conventional	24	18	0.38	0.63	4.75	3D	2.5	2.41	9.88	1.5
Expy/Fwy	30	24	0.5	0.75	6.0	4D	4.0	3.21	12.84	1.88

R8-3D

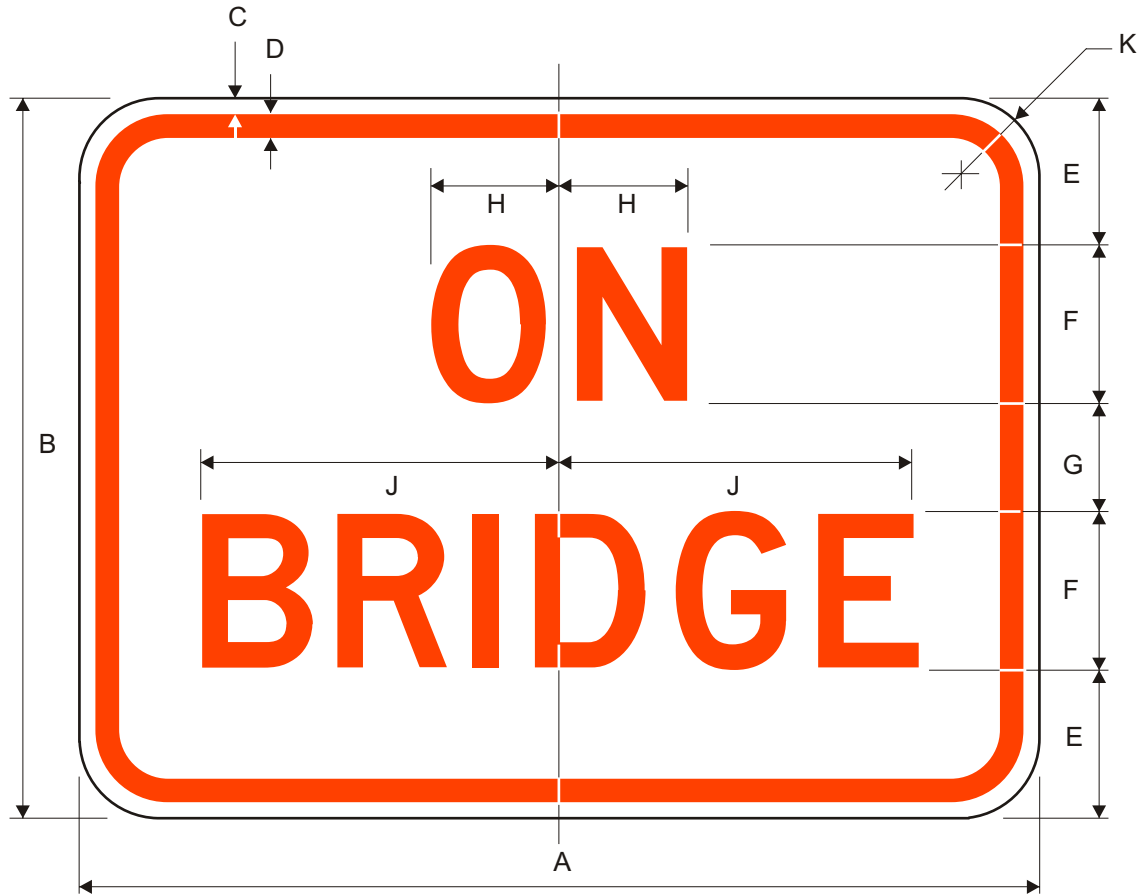

Border and Legend: Red
Background: White

Road Class	Dimensions (inches)									
	A	B	C	D	E	F	G	H	J	K
Minimum	18	12	0.38	0.63	2.0	3D	2.0	2.41	6.72	1.5
Conventional	24	18	0.38	0.63	3.75	4D	2.5	3.21	8.96	1.5
Expy/Fwy	30	24	0.50	0.75	5.0	5D	4.0	4.02	11.21	1.88



Border and Legend: Black
 Background: White

Road Class	Dimensions (inches)								
	A	B	C	D	E	F	G	H	J
Expressway	30	24	0.38	0.63	3.50	4C	2.50	4D	1.50
Freeway	48	36	0.63	0.88	5.00	6C	4.00	6D	2.25

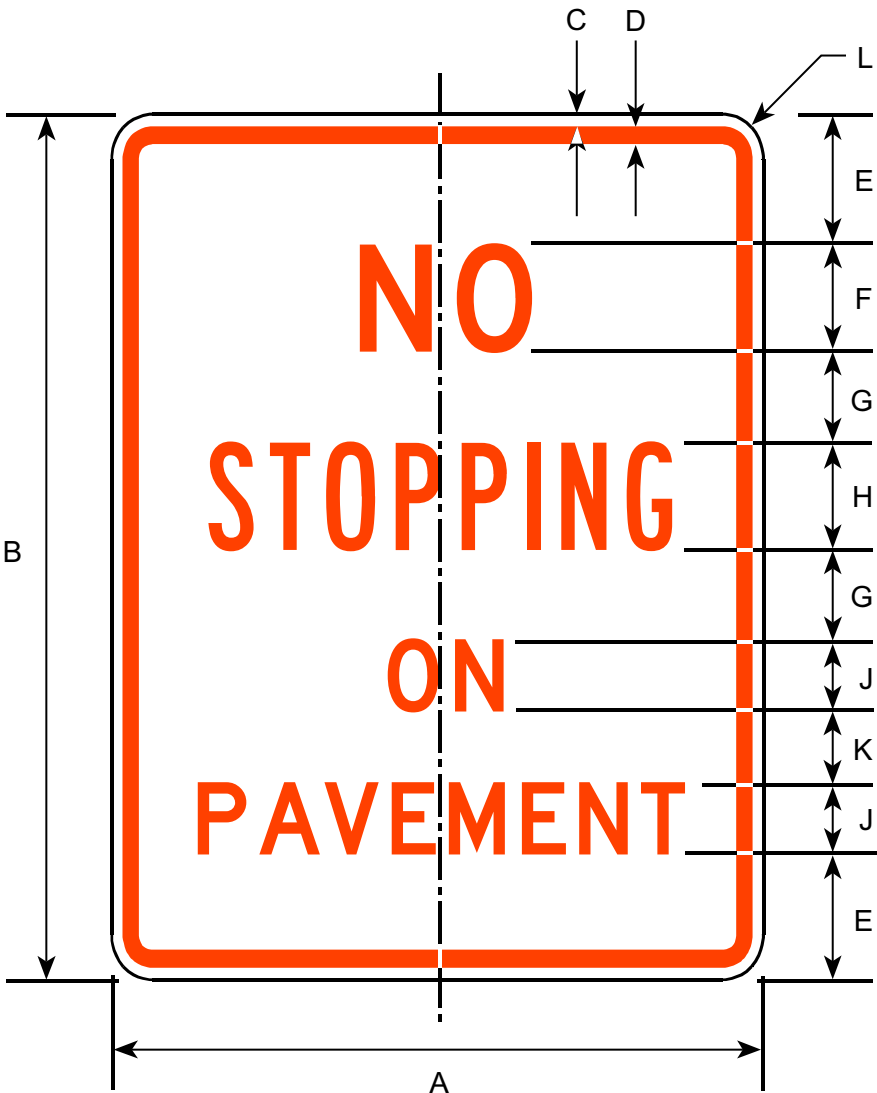

Border and Legend: Red
Background: White

Road Class	Dimensions (inches)										
	A	B	C	D	E	F	G	H	J	K	L
Minimum	18	24	0.38	0.63	3.50	3D	2.50	3B	2D	2.00	1.50
Conventional	24	30	0.38	0.63	3.63	5D	2.25	5B	3D	2.25	1.50
Expressway	36	48	0.63	0.88	6.00	7D	5.00	7B	4D	4.00	2.25
Freeway	48	60	0.75	1.25	7.50	9D	6.00	9B	5D	5.00	3.00

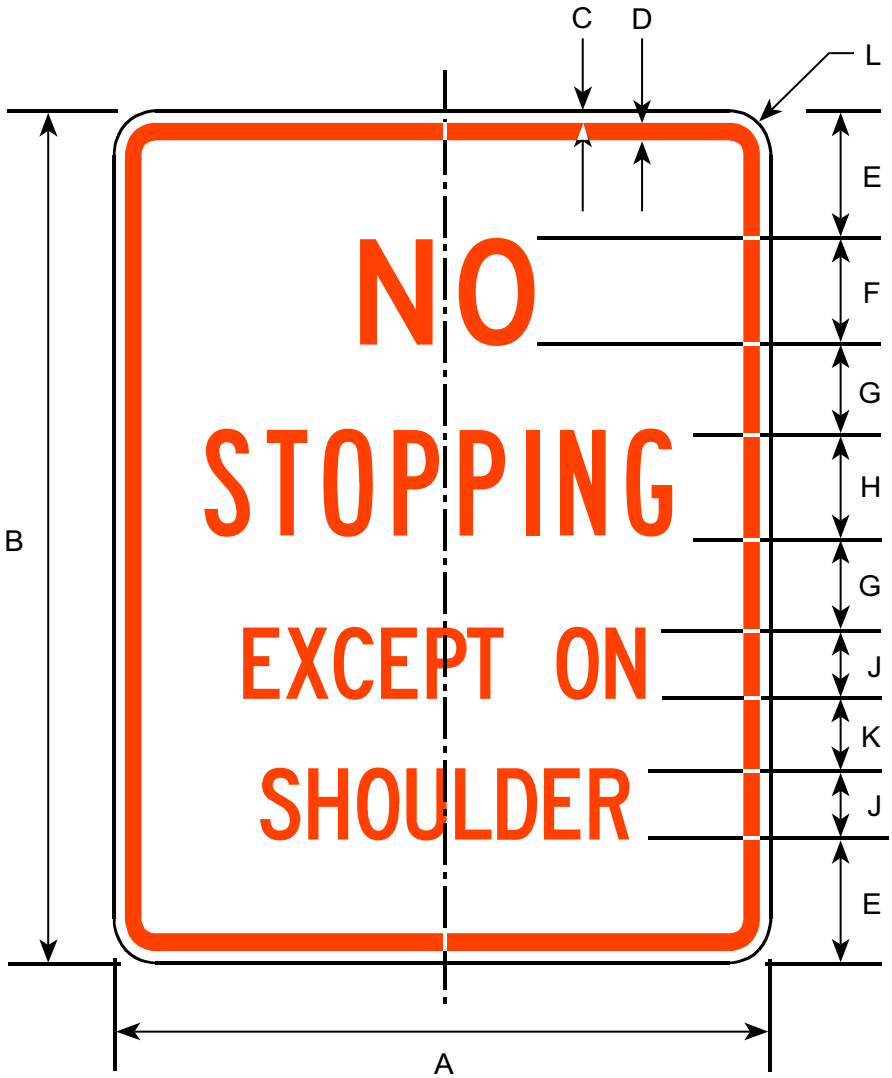

Border and Legend: Red
 Background: White

Road Class	Dimensions (inches)										
	A	B	C	D	E	F	G	H	J	K	L
Minimum	18	24	0.38	0.63	3.50	3D	2.50	3B	2C	2.00	1.50
Conventional	24	30	0.38	0.63	3.63	5D	2.25	5B	3C	2.25	1.50
Expressway	36	48	0.63	0.88	6.00	7D	5.00	7B	4C	4.00	2.25
Freeway	48	60	0.75	1.25	7.50	9D	6.00	9B	5C	5.00	3.00



Border and Legend: Black
 Background: White

Road Class	Dimensions (inches)									
	A	B	C	D	E	F	G	H	J	
Expressway	30	24	0.38	0.63	3.50	4C	2.50	4D	1.50	
Freeway	48	36	0.63	0.88	5.00	6C	4.00	6D	2.25	

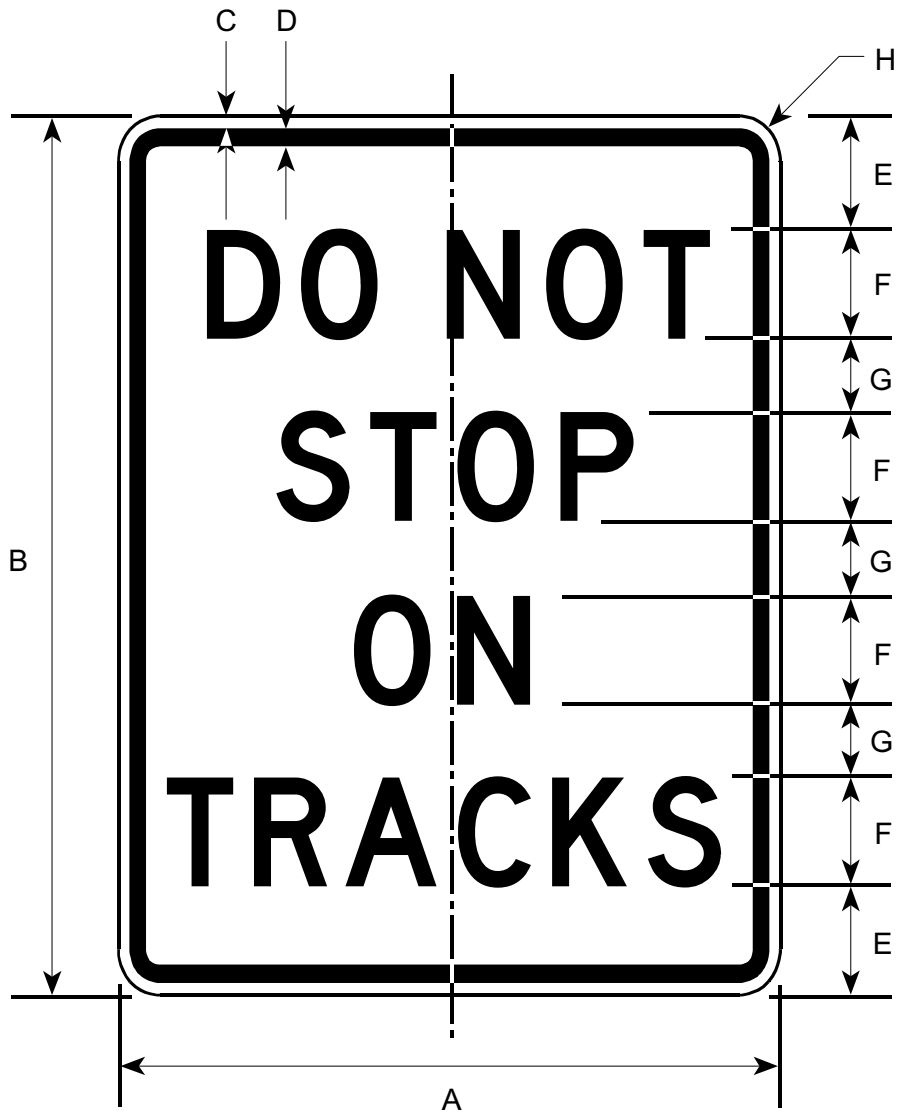

Border and Legend: Black
 Background: White

Road Class	Dimensions (inches)							
	A	B	C	D	E	F	G	H
Minimum	24	30	0.38	0.63	3.63	4D	2.25	1.50
Conventional	36	48	0.63	0.88	6.00	6D	4.00	2.25
Expwy/Frwy	48	60	0.75	1.25	7.25	8D	4.50	3.00

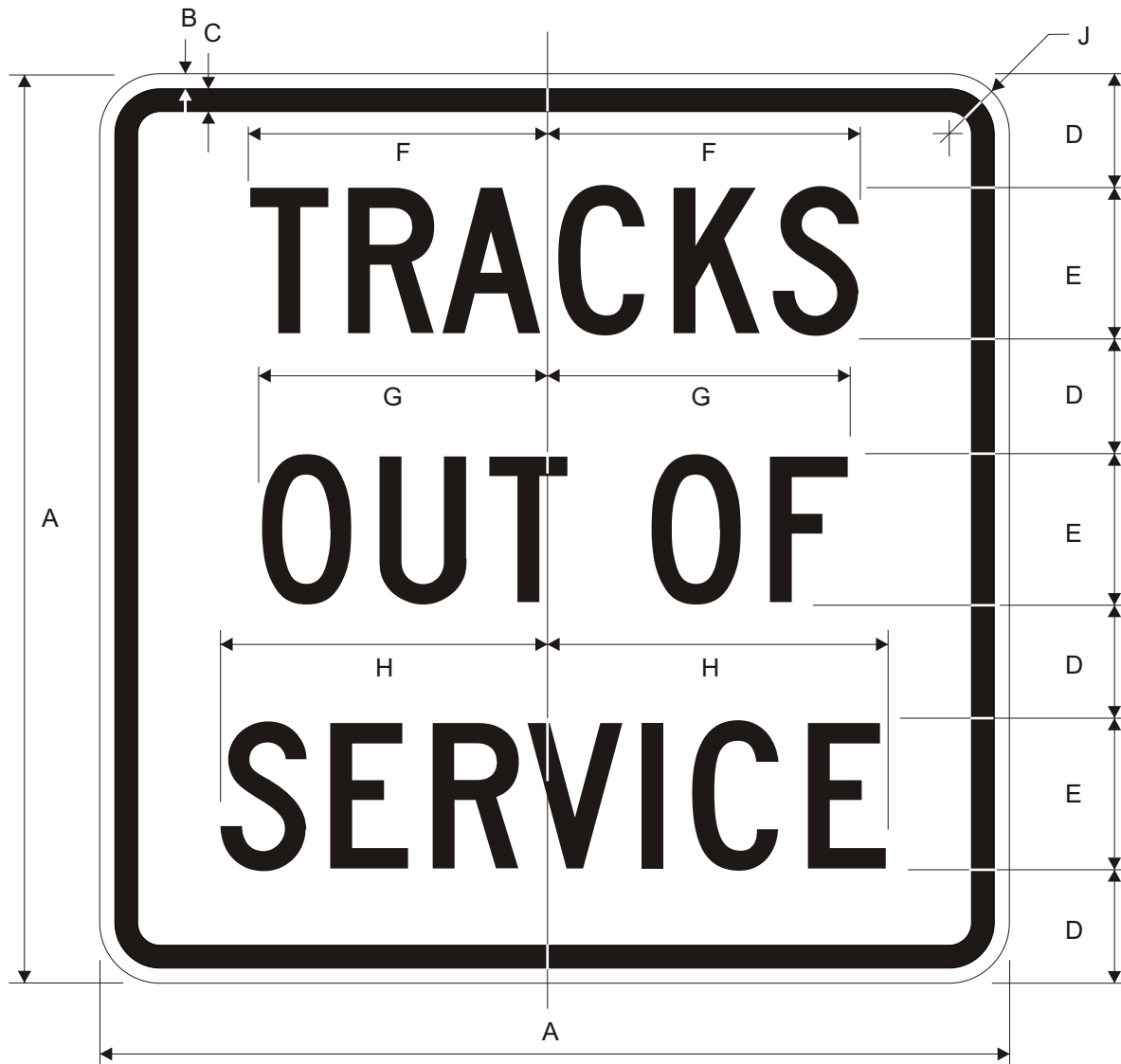

Border and Legend: Black
 Background: White

Road Class	Dimensions (inches)								
	A	B	C	D	E	F	G	H	J
Bike	18	0.38	0.63	2.25	3C	6.06	5.86	6.61	1.5
Expy.	36	0.63	0.88	4.5	6C	12.13	11.71	13.23	2.25
Oversized	48	0.75	1.25	6.0	8C	16.17	15.63	17.65	3.0

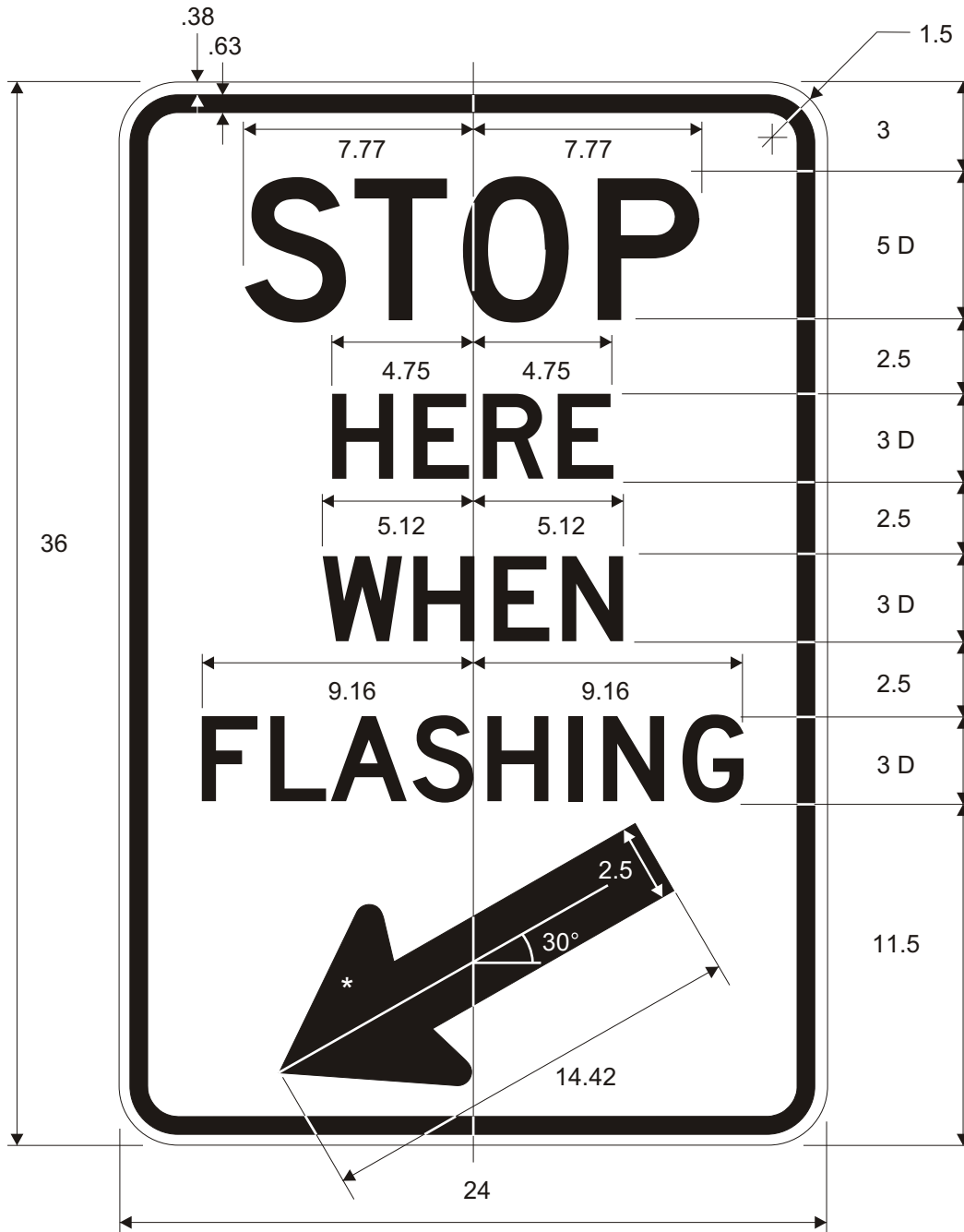

Border, Symbol and Legend: Red
 Background: White

*See Appendix B-1 for Standard Arrow Details.

R8-100



Border and Legend: Red
Background: White

Road Class	Dimensions (inches)											
	A	B	C	D	E	F	G	H	J	K	L	M
Conv & Min	30	36	0.38	0.63	4.6	7D	2.75	6D	4C	2.25	2.65	1.5



Border and Legend: Green
 Background: White

Road Class	Dimensions (inches)							
	A	B	C	D	E	F	G	H
Conv & Min	18	24	0.38	0.63	4C	4B	3	1.5

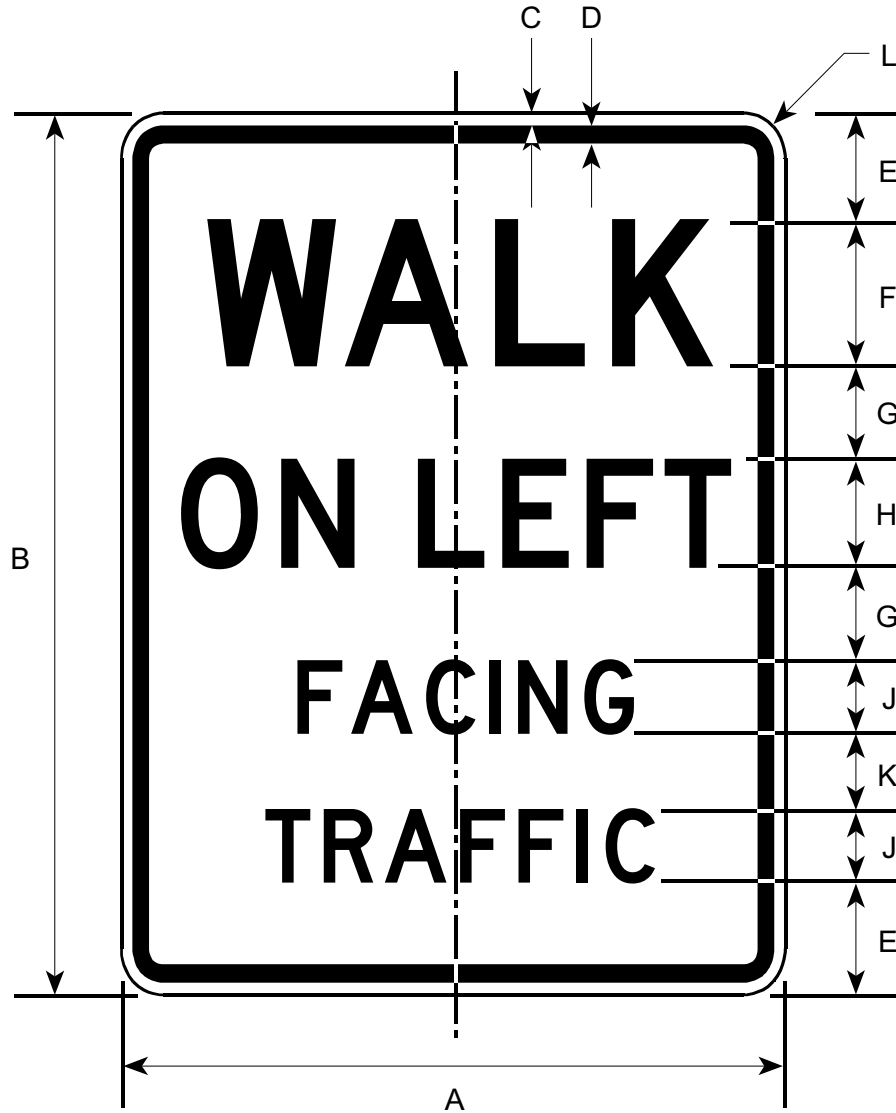

Border and Legend: Black
Background: White

Road Class	Dimensions (inches)										
	A	B	C	D	E	F	G	H	J	K	L
Conv & Min	18	24	0.38	0.63	3	4D	2.50	3D	2D	2	1.50

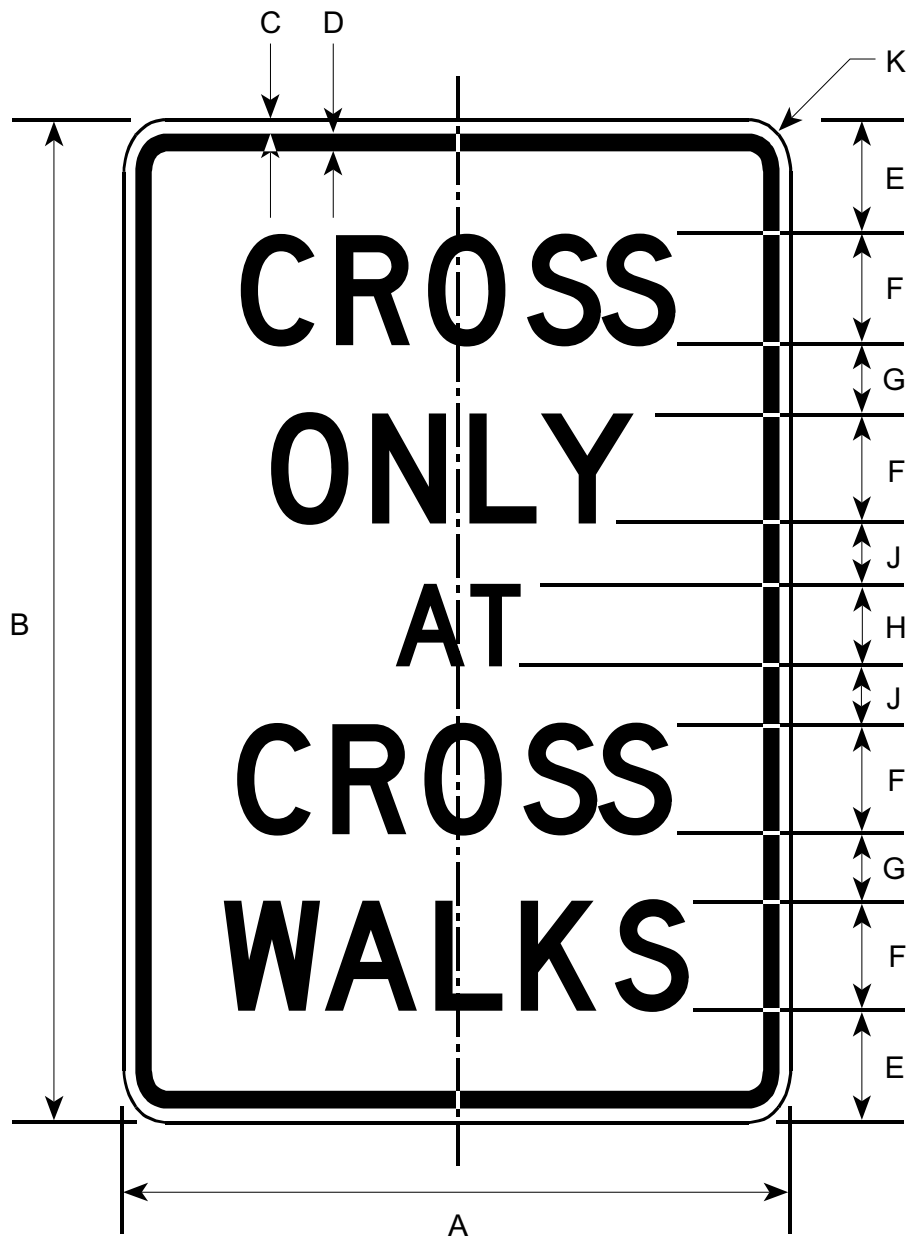

Border and Legend: Black
Background: White

Road Class	Dimensions (inches)									
	A	B	C	D	E	F	G	H	J	K
Conv & Min	12	18	0.38	0.38	2	2D	1.25	1.5D	1	1.5

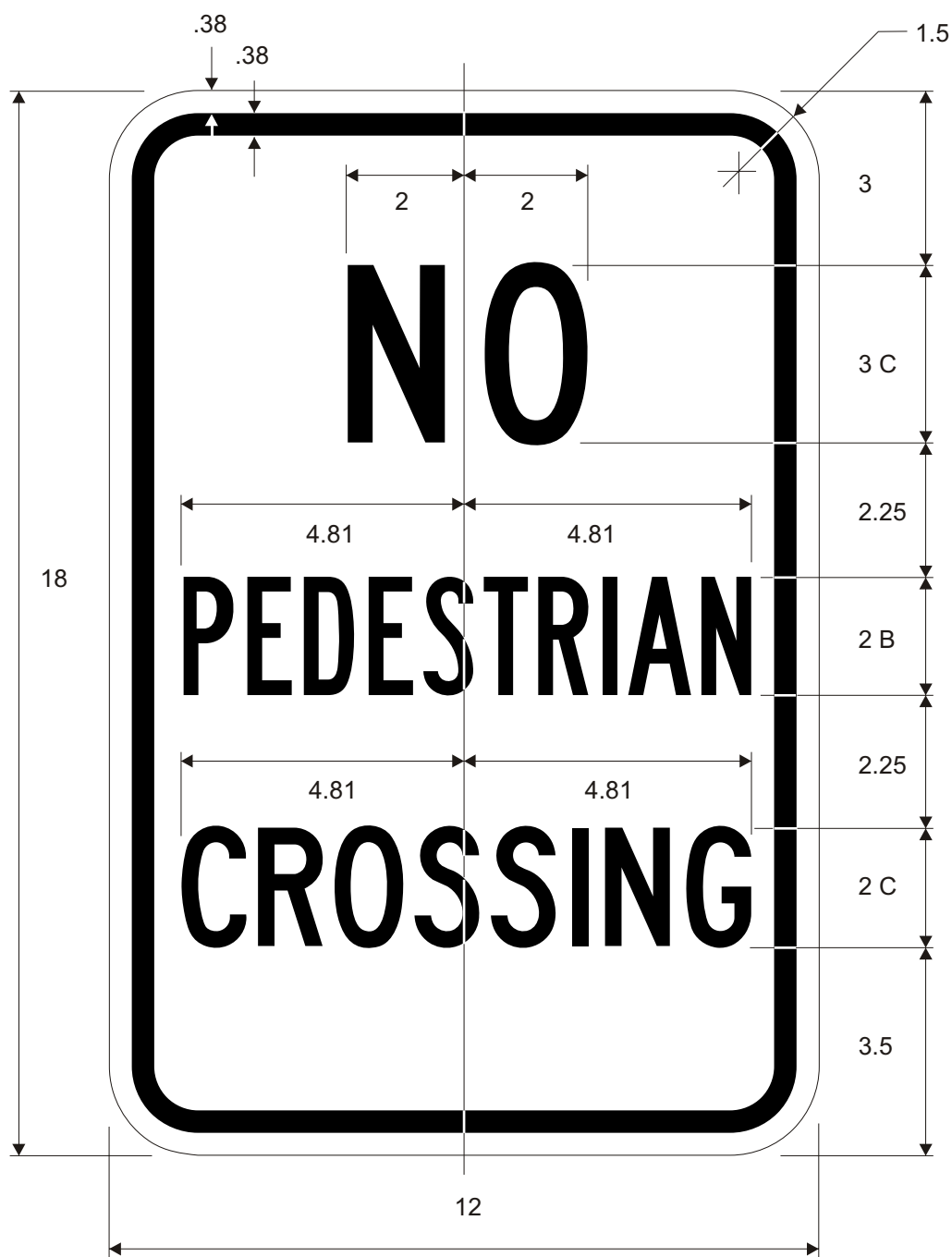

Border and Legend: Black
 Background: White

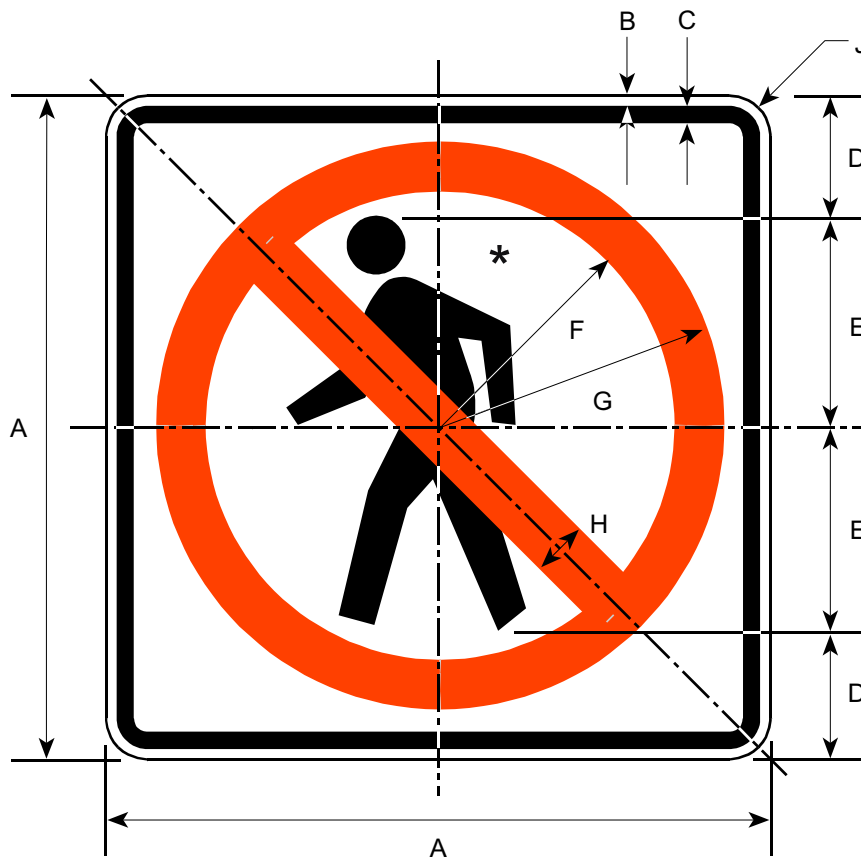

Border and Man: Black
 Circle and Diagonal: Red
 Background: White

* Make symbol proportional to the one shown.

Road Class	Dimensions (inches)								
	A	B	C	D	E	F	G	H	J
Conv & Min	18	0.38	0.63	3.50	5.50	6.38	7.63	1.5	1.5
Expressway	24	0.38	0.63	4.50	7.50	8.50	10.50	2.0	2.0
Freeway	30	0.50	0.75	5.75	9.25	10.63	13.13	2.5	2.5

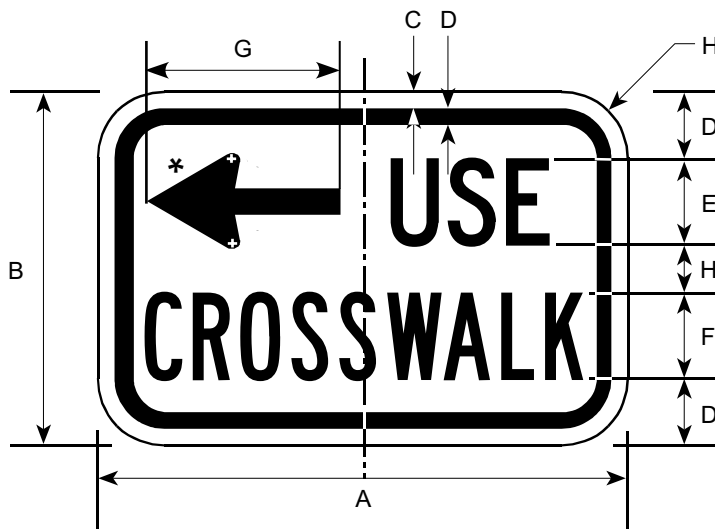

R9-3BL

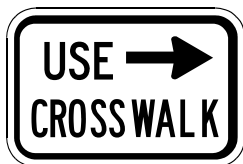

R9-3BR

Border and Legend: Black
Background: White

*See Appendix B-1 for Standard Arrow Details.

Road Class	Dimensions (inches)							
	A	B	C	D	E	F	G	H
Conv & Min	18	12	0.38	2.25	3C	3B	6.0	1.5

R9-3C

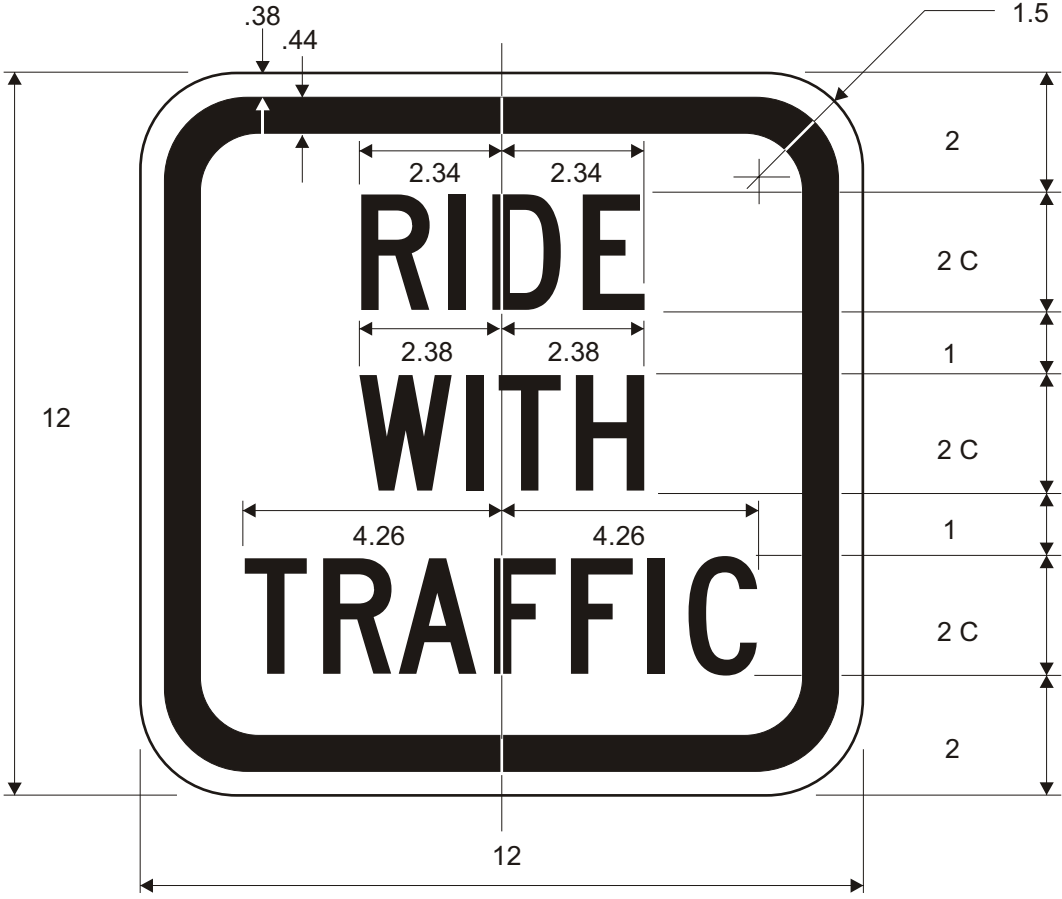

Border and Legend: Black
Background: White



Border and Legend: Black
Background: White

Road Class	Dimensions (inches)									
	A	B	C	D	E	F	G	H	J	
Conv & Min	18	24	0.38	0.63	3	6C	2	4C	1.5	

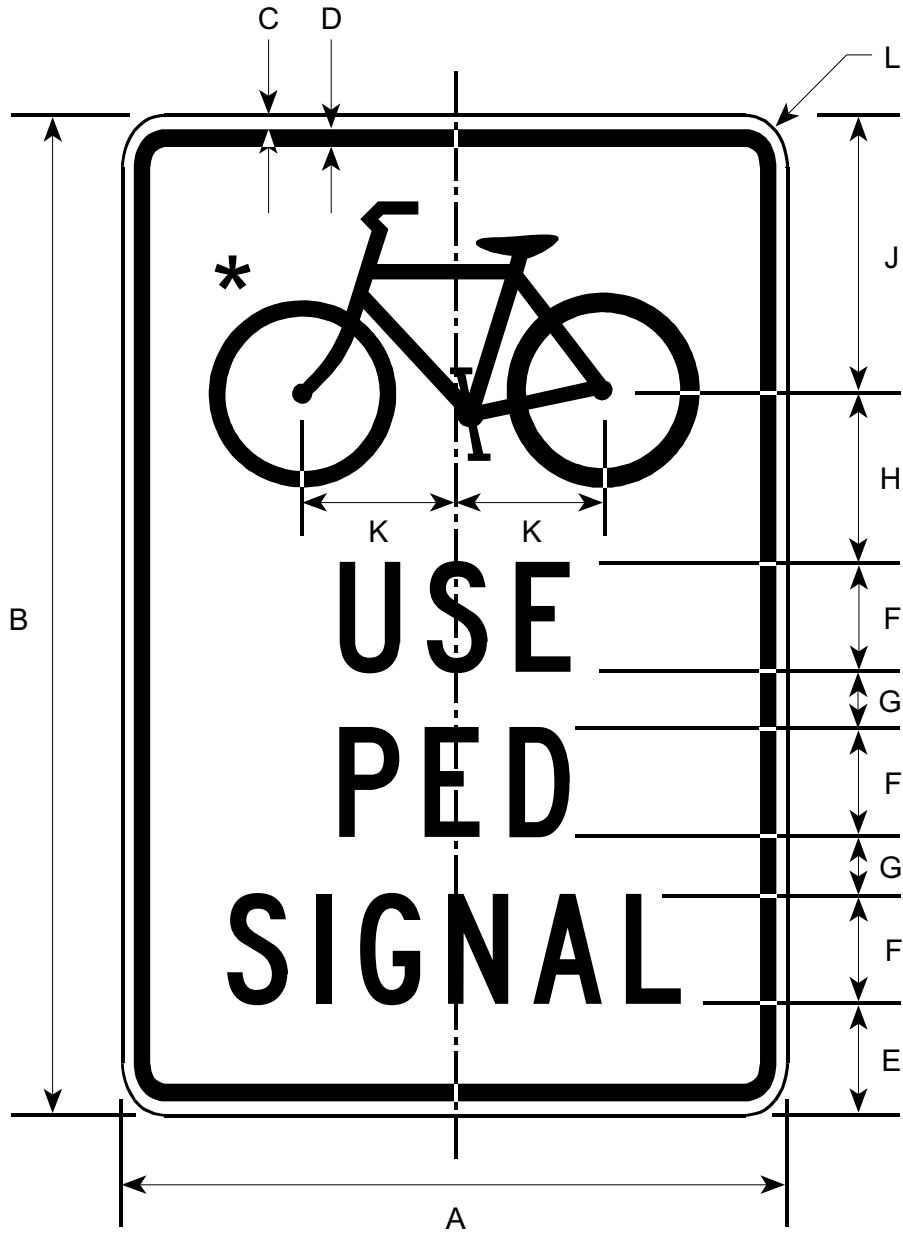

Border and Legend: Black
Background: White

* Make symbol proportional
to the one shown.

Road Class	Dimensions (inches)										
	A	B	C	D	E	F	G	H	J	K	L
Conv & Min	12	18	0.38	0.38	2	2C	1	3	5	2.75	1.5

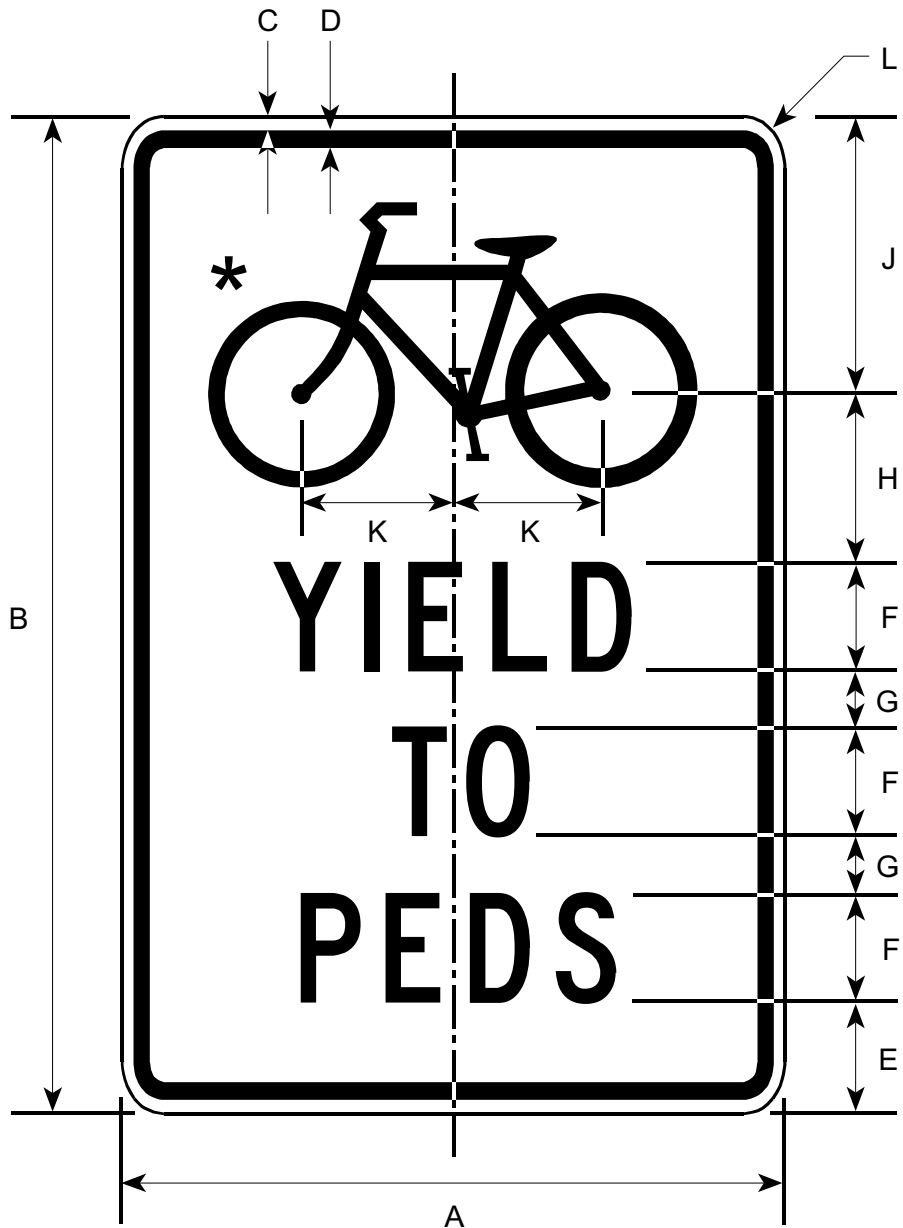

Border and Legend: Black
Background: White

* Make symbol proportional
to the one shown.

Road Class	Dimensions (inches)										
	A	B	C	D	E	F	G	H	J	K	L
Conv & Min	12	18	0.38	0.38	2	2C	1	3	5	2.75	1.5

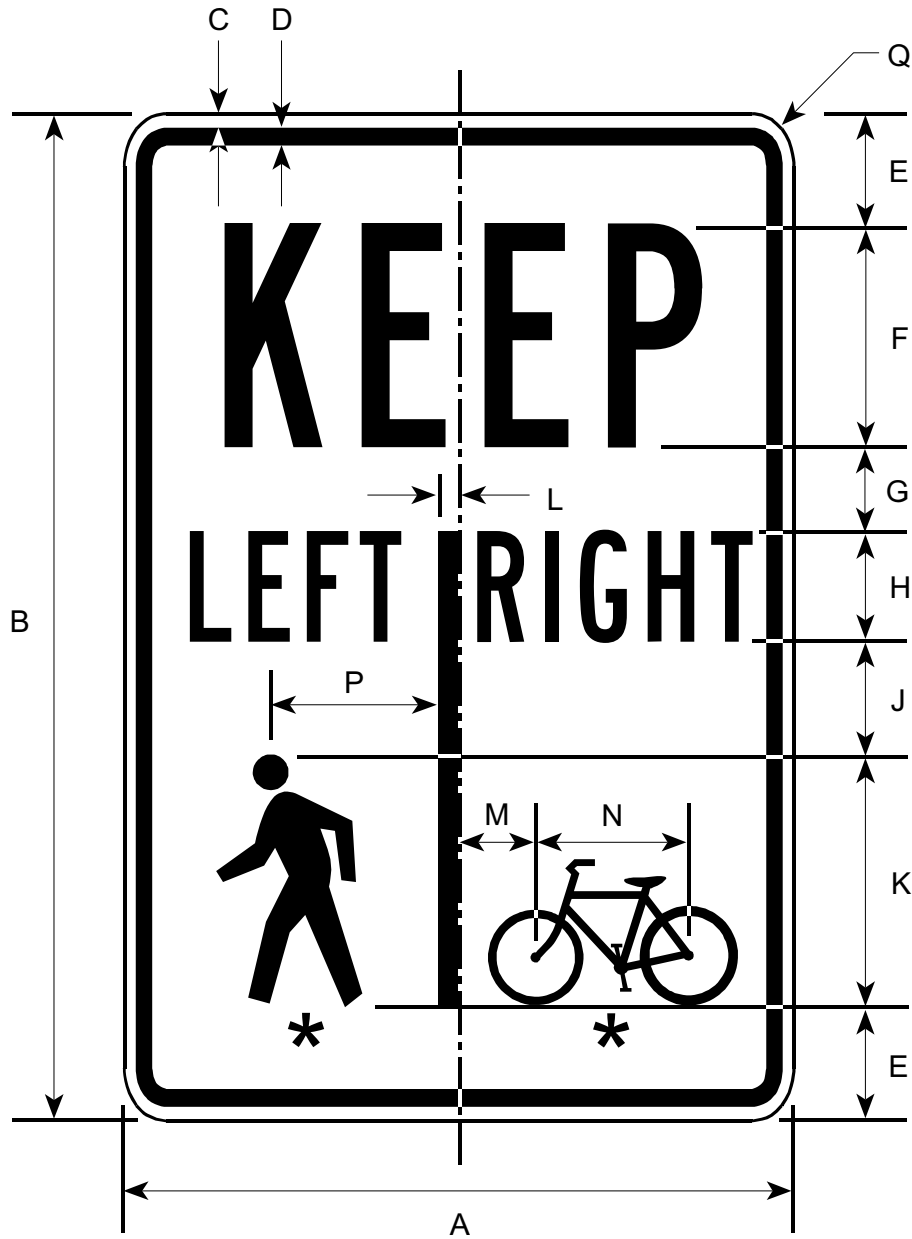

Border and Legend: Black
Background: White

* Make symbol proportional
to the one shown.

Road Class	Dimensions (inches)															
	A	B	C	D	E	F	G	H	J	K	L	M	N	P	Q	
Conv & Min	12	18	0.38	0.38	2	4B	1.5	2B	2	4.5	0.38	1.25	2.75	3.25	1.5	

R9-8

R9-9

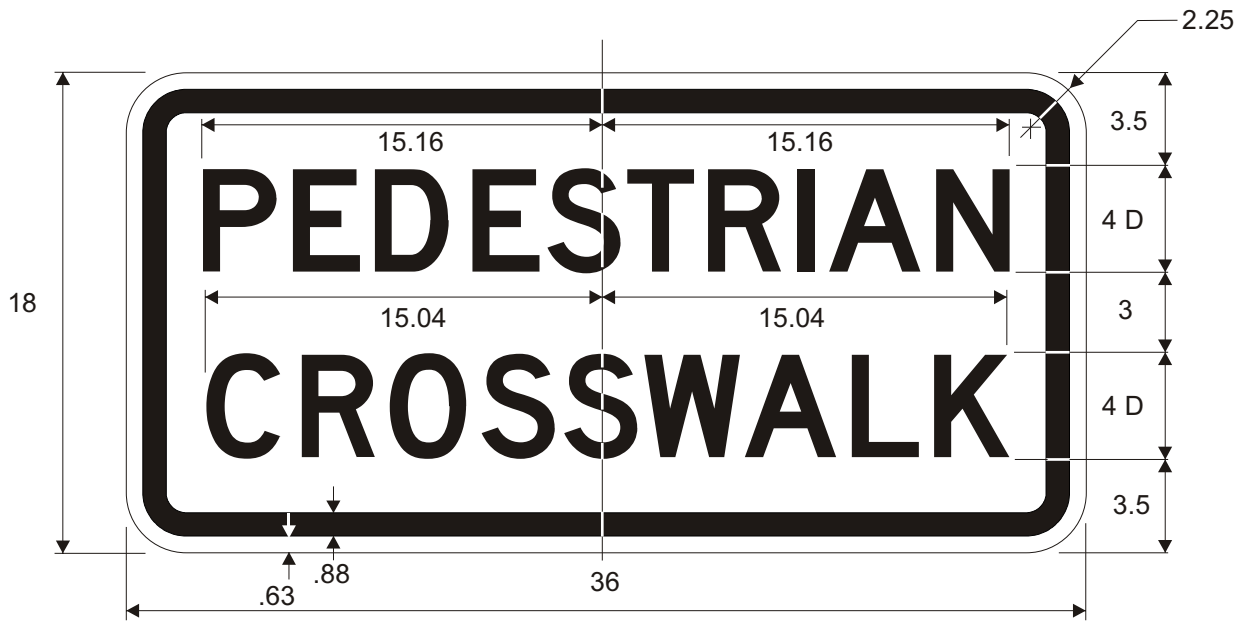

R9-8

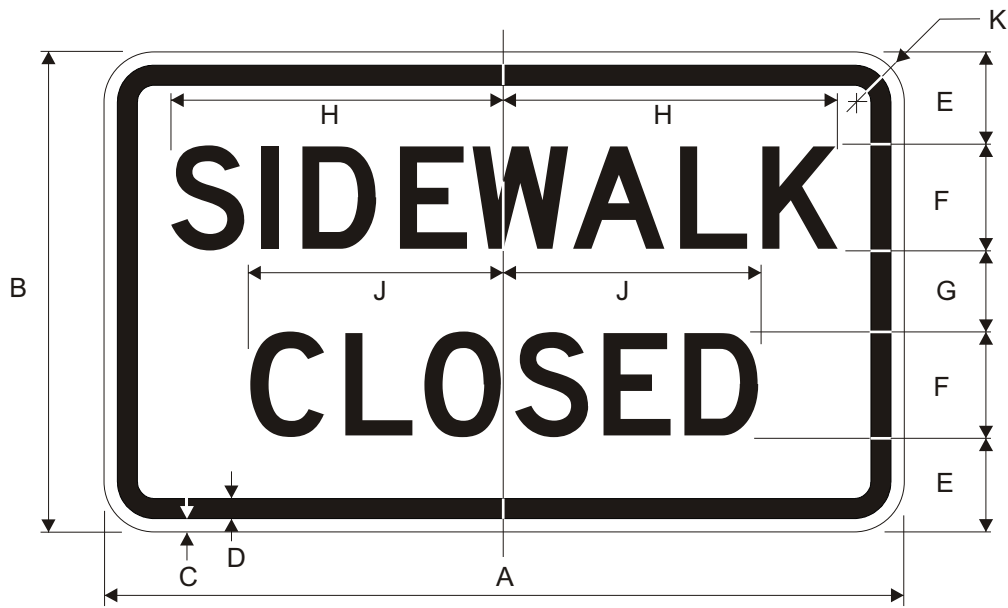

R9-9

Border and Legend: Black
Background: White

Road Class	Dimensions (inches)									
	A	B	C	D	E	F	G	H	J	K
Min.	24	12	0.38	0.63	2.13	3D*	1.75	9.37	7.23	1.5
Conv.	30	18	0.63	0.88	3.5	4D*	3.0	12.49	9.62	2.25

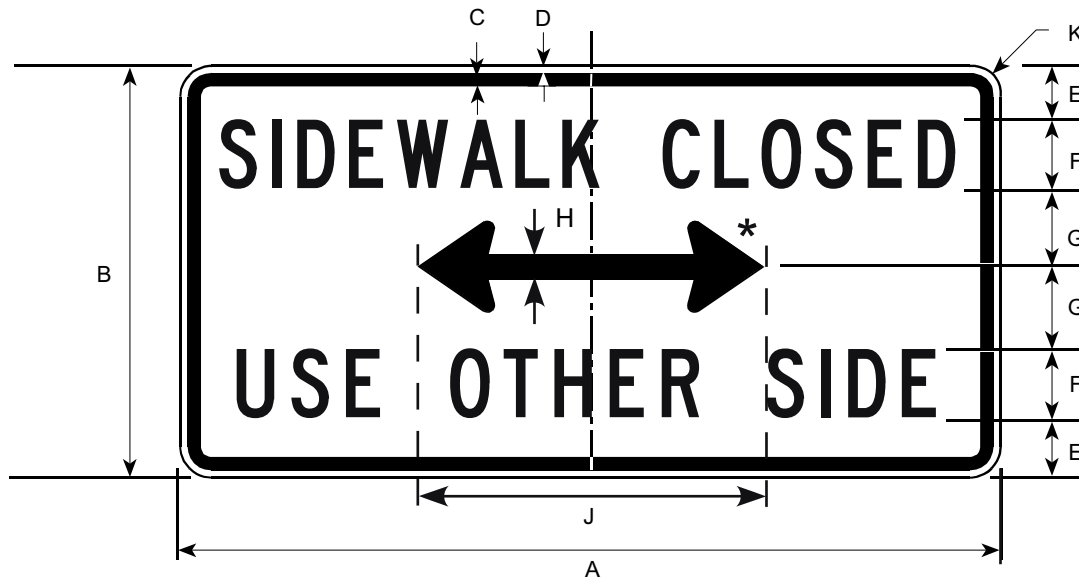

Border and Legend: Black
Background: White

*See Appendix B-1 for Standard Arrow Details.

Road Class	Dimensions (inches)									
	A	B	C	D	E	F	G	H	J	K
Conv & Min	24	12	0.63	0.38	1.5	2C	2.5	1.3	12	1.5

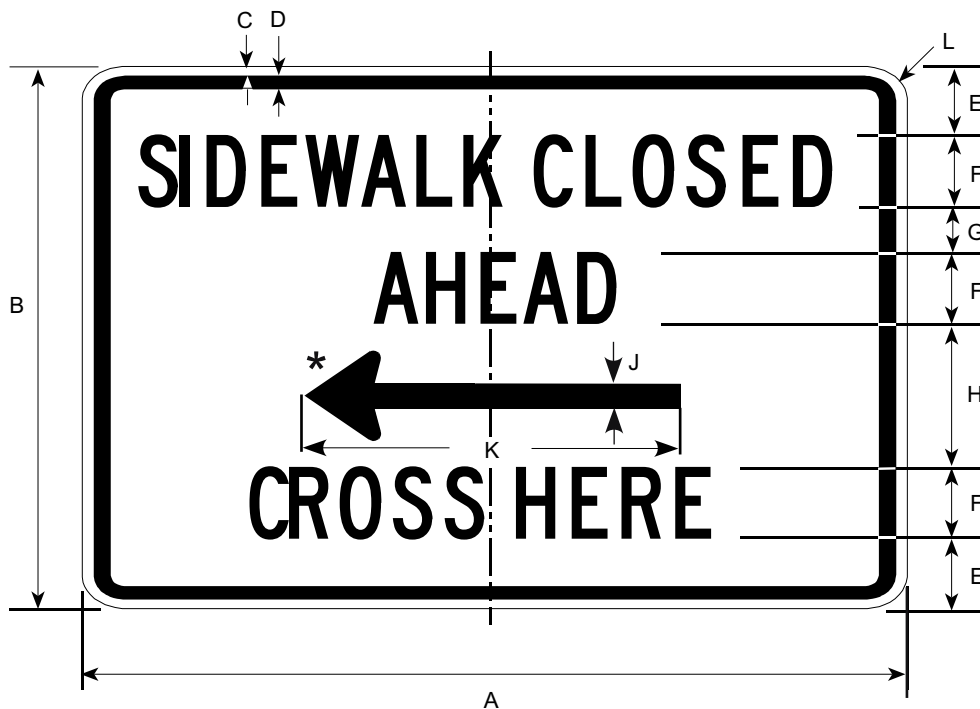

Border and Legend: Black
 Background: White

*See Appendix B-1 for Standard Arrow Details.

Road Class	Dimensions (inches)										
	A	B	C	D	E	F	G	H	J	K	L
Conv & Min	36	24	0.38	0.63	3.0	3C	2.0	7.0	1.3	12	1.5

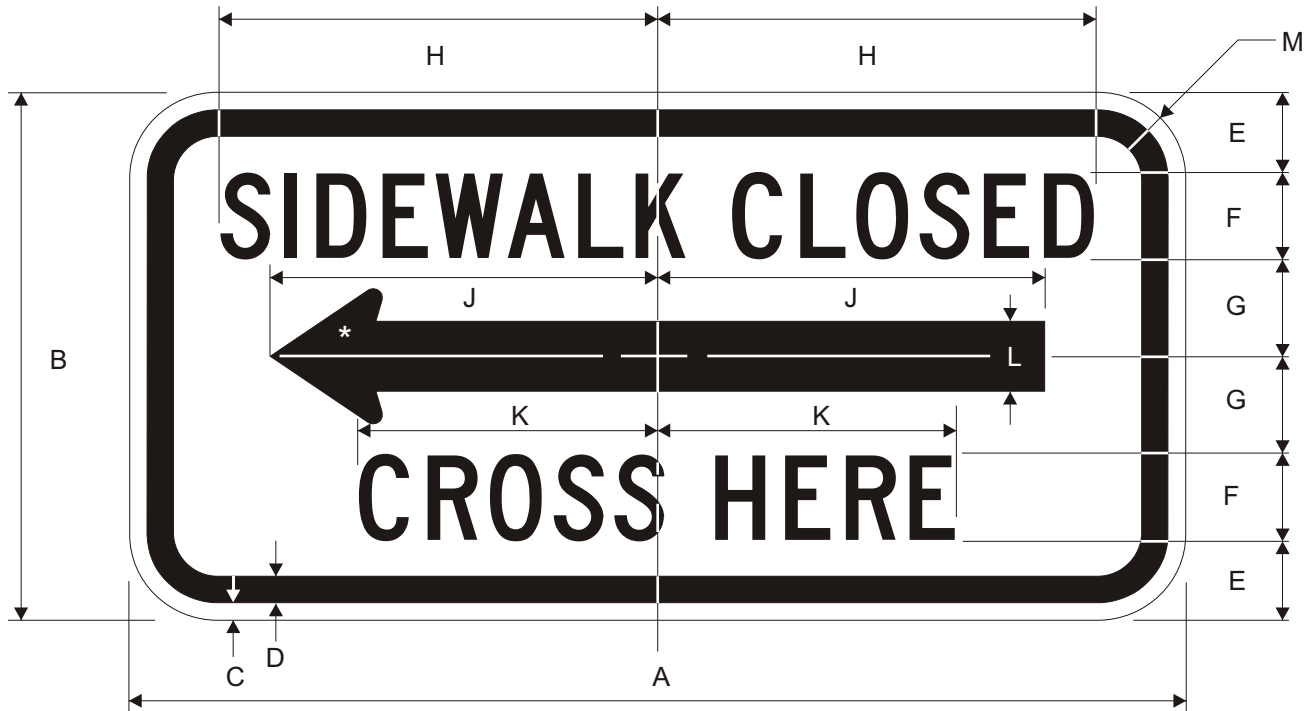

Border and Legend: Black
Background: White

*See Appendix B-1 for Standard Arrow Details.

Road Class	Dimensions (inches)											
	A	B	C	D	E	F	G	H	J	K	L	M
Conv/Min	24	12	0.38	0.63	1.75	2C	2.25	9.97	8.75	7.79	1.6	1.5

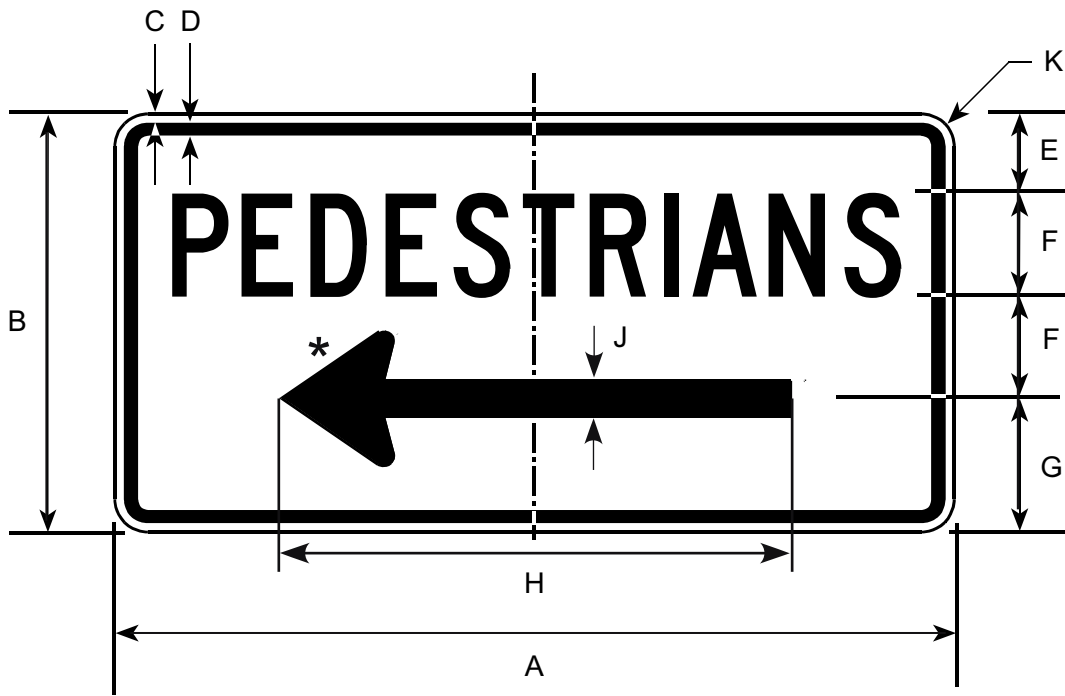

Border and Legend: Black
Background: White

*See Appendix B-1 for Standard Arrow Details.

Road Class	Dimensions (inches)									
	A	B	C	D	E	F	G	H	J	K
Conv & Min	24	12	0.38	0.63	3	3C	3	13.5	1.3	1.5



Border and Legend: Black
 Background: White

* Make Symbols proportional to sign drawing.

Road Class	Dimensions (inches)									
	A	B	C	D	E	F	G	H	J	
Conv & Min	24	24	0.38	0.63	4	3D	8	5	1.5	

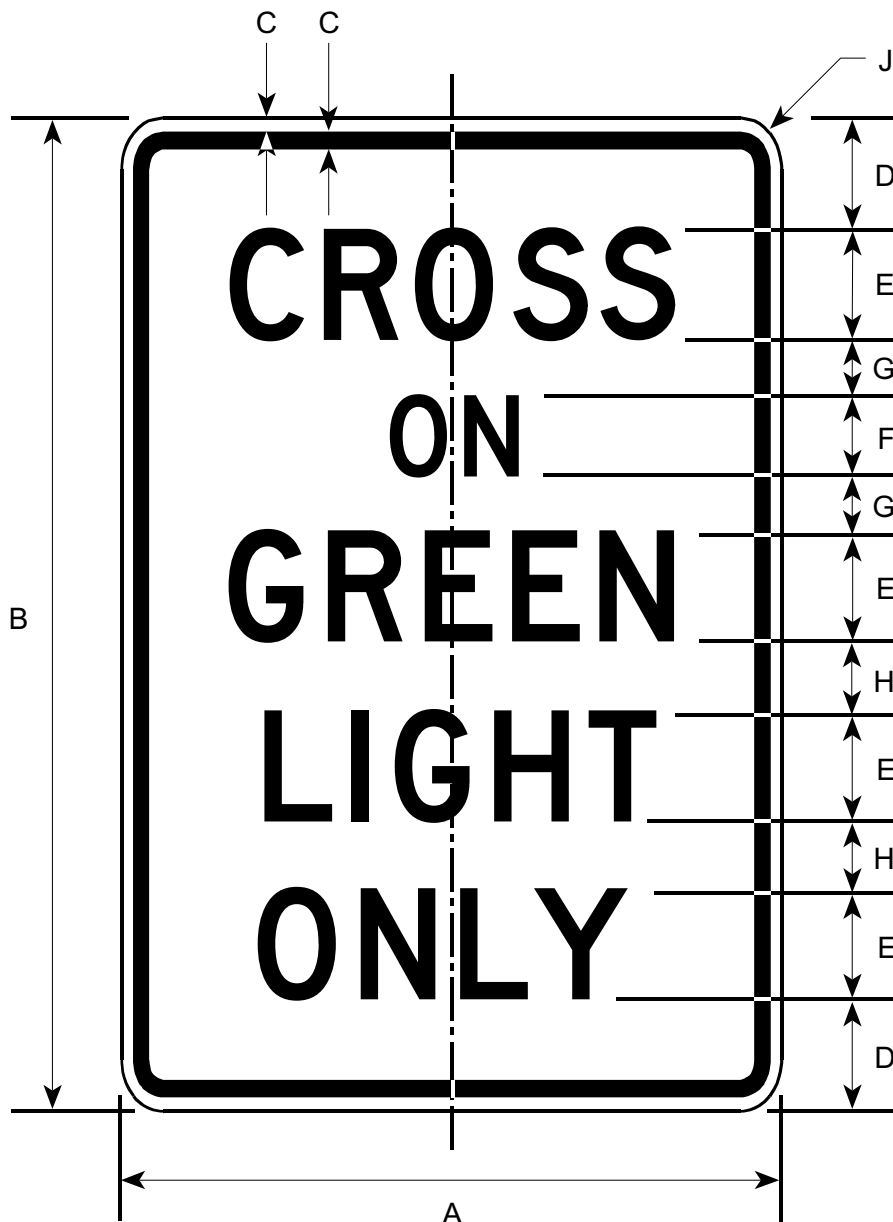

Border and Legend: Black
 Background: White

Road Class	Dimensions (inches)								
	A	B	C	D	E	F	G	H	J
Conv & Min	12	18	0.38	2	2D	1.5D	1	1.25	1.5

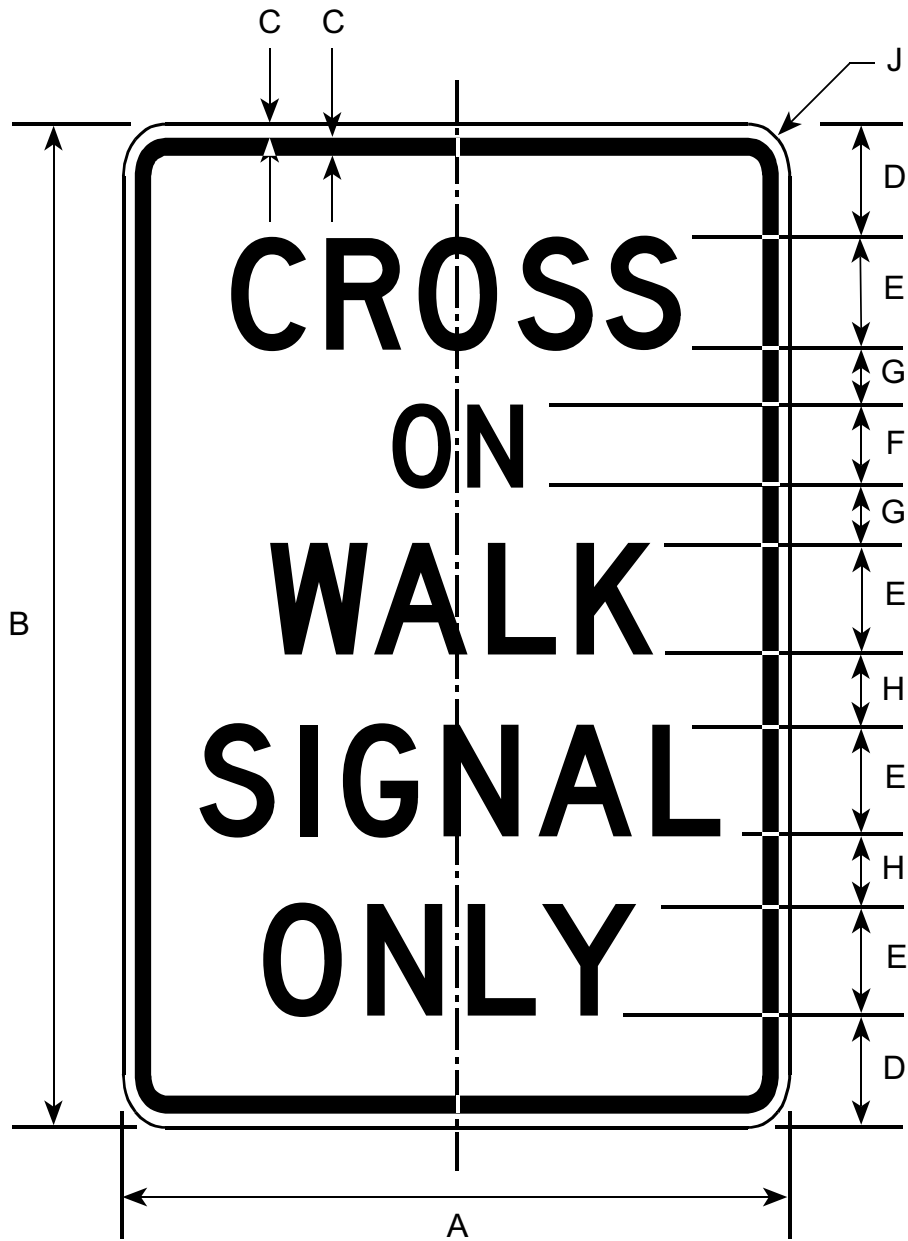

Border and Legend: Black
Background: White

Road Class	Dimensions (inches)								
	A	B	C	D	E	F	G	H	J
Conv & Min	12	18	0.38	2	2D	1.5D	1	1.25	1.5

R10-2A

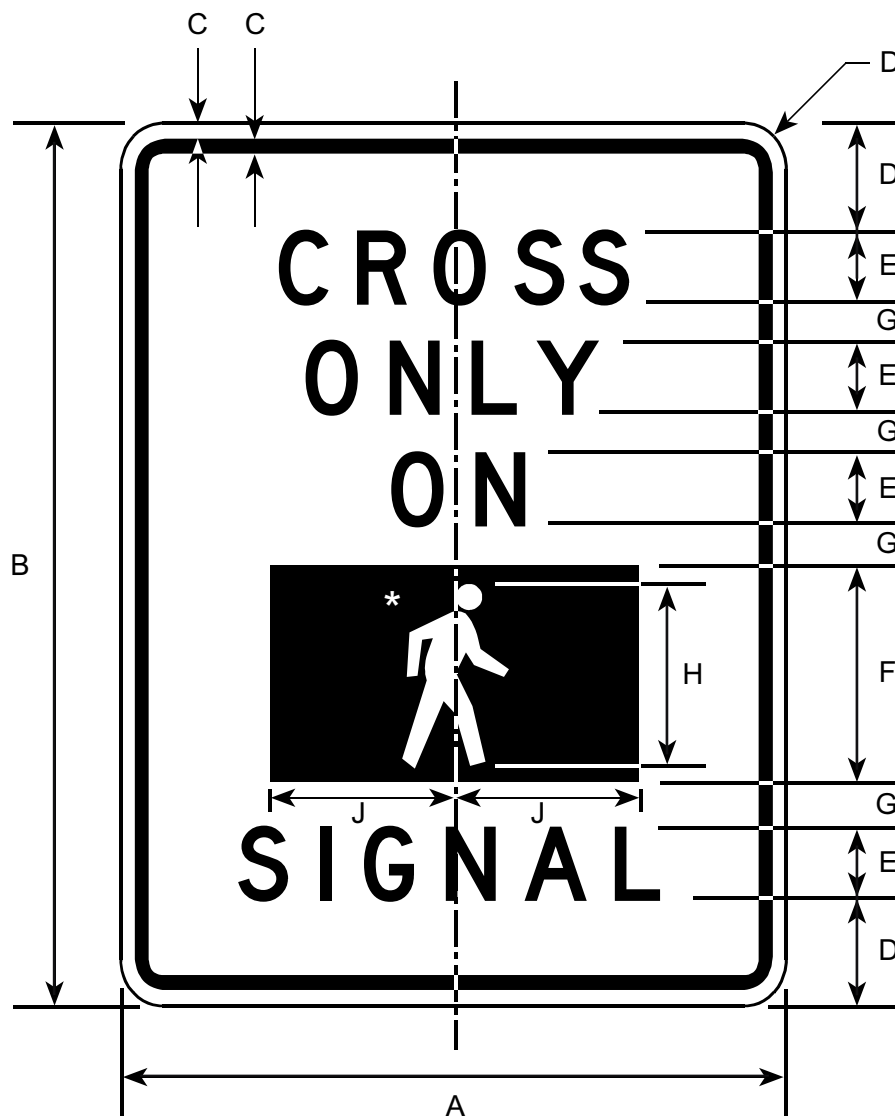

Border and Legend: Black
Background: White

* Make symbol proportional
to the one shown.

Road Class	Dimensions (inches)								
	A	B	C	D	E	F	G	H	J
Conv & Min	9	12	0.38	1.5	1D	3	0.5	2.5	2

R10-3A

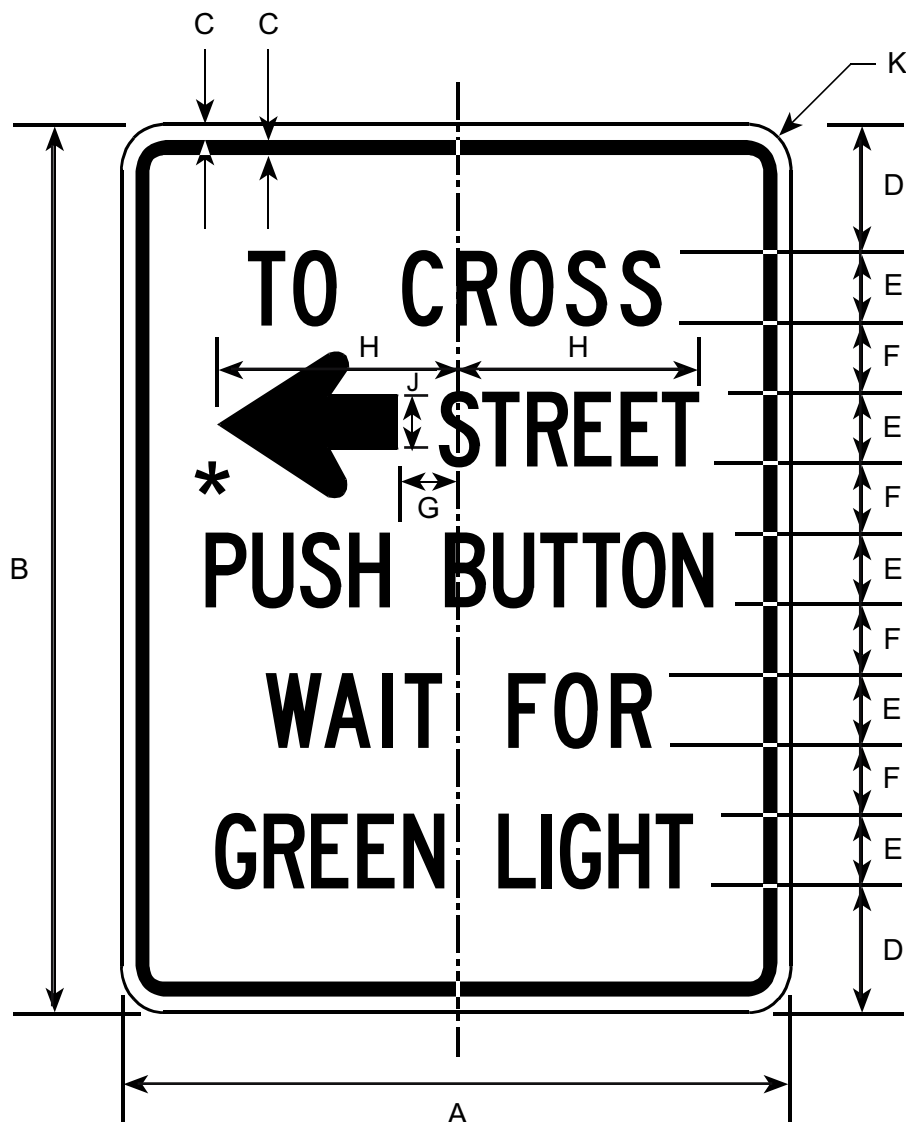

Border and Legend: Black
Background: White

*See Appendix B-1 for Standard Arrow Details.

Road Class	Dimensions (inches)									
	A	B	C	D	E	F	G	H	J	K
Conv & Min	9	12	0.38	1.5	1C	1.0	0.5	3.25	0.75	1.5

R10-3B

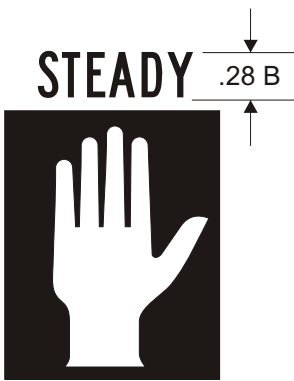
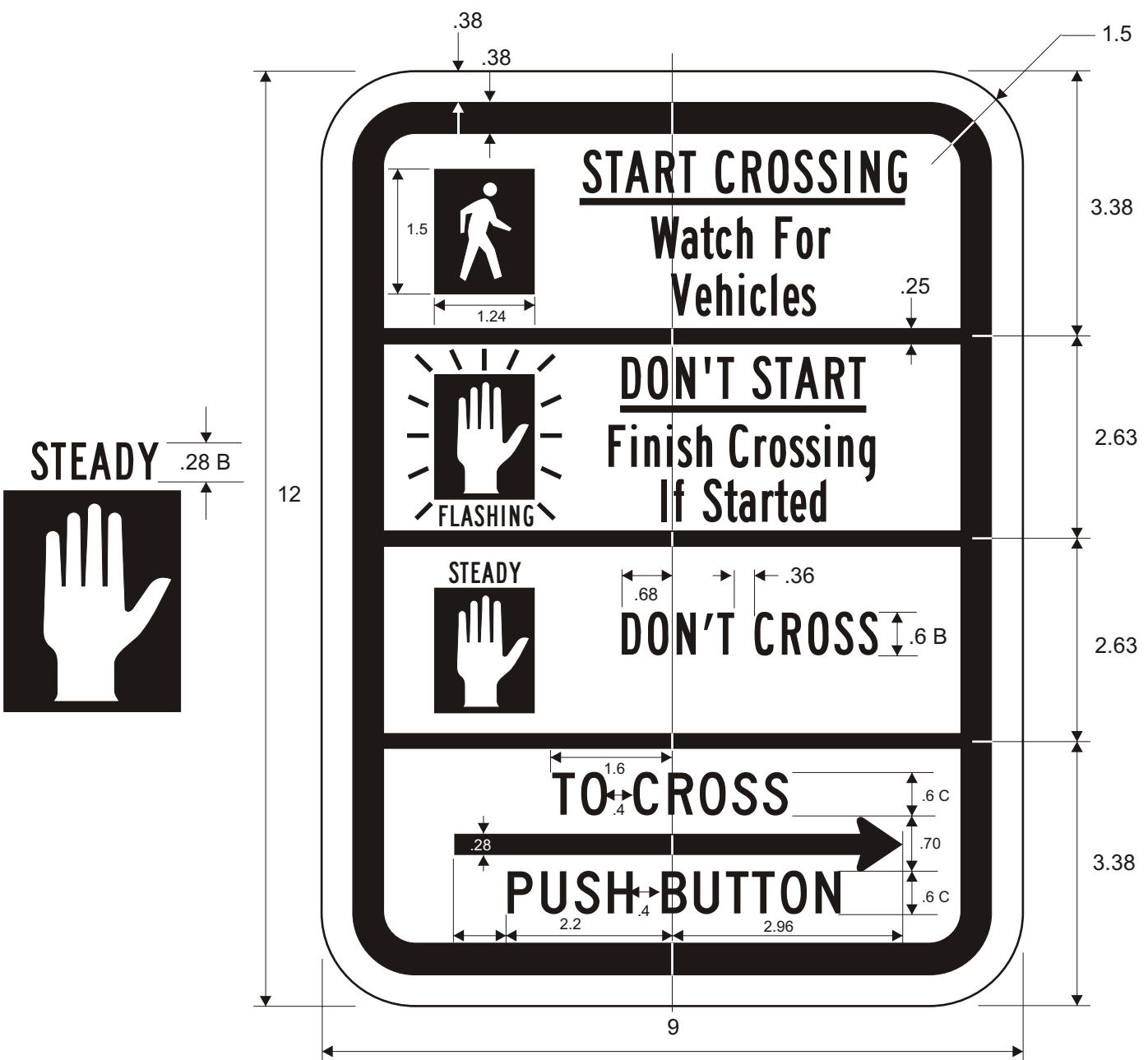

Legend and Border: Black
 Background: White
 Hand Symbol: Orange

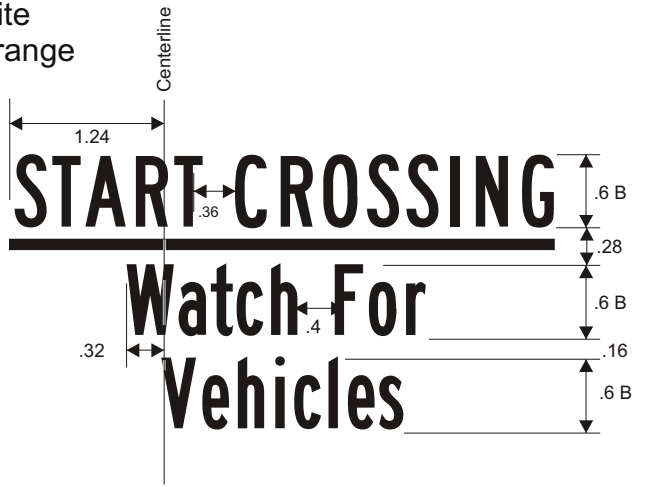

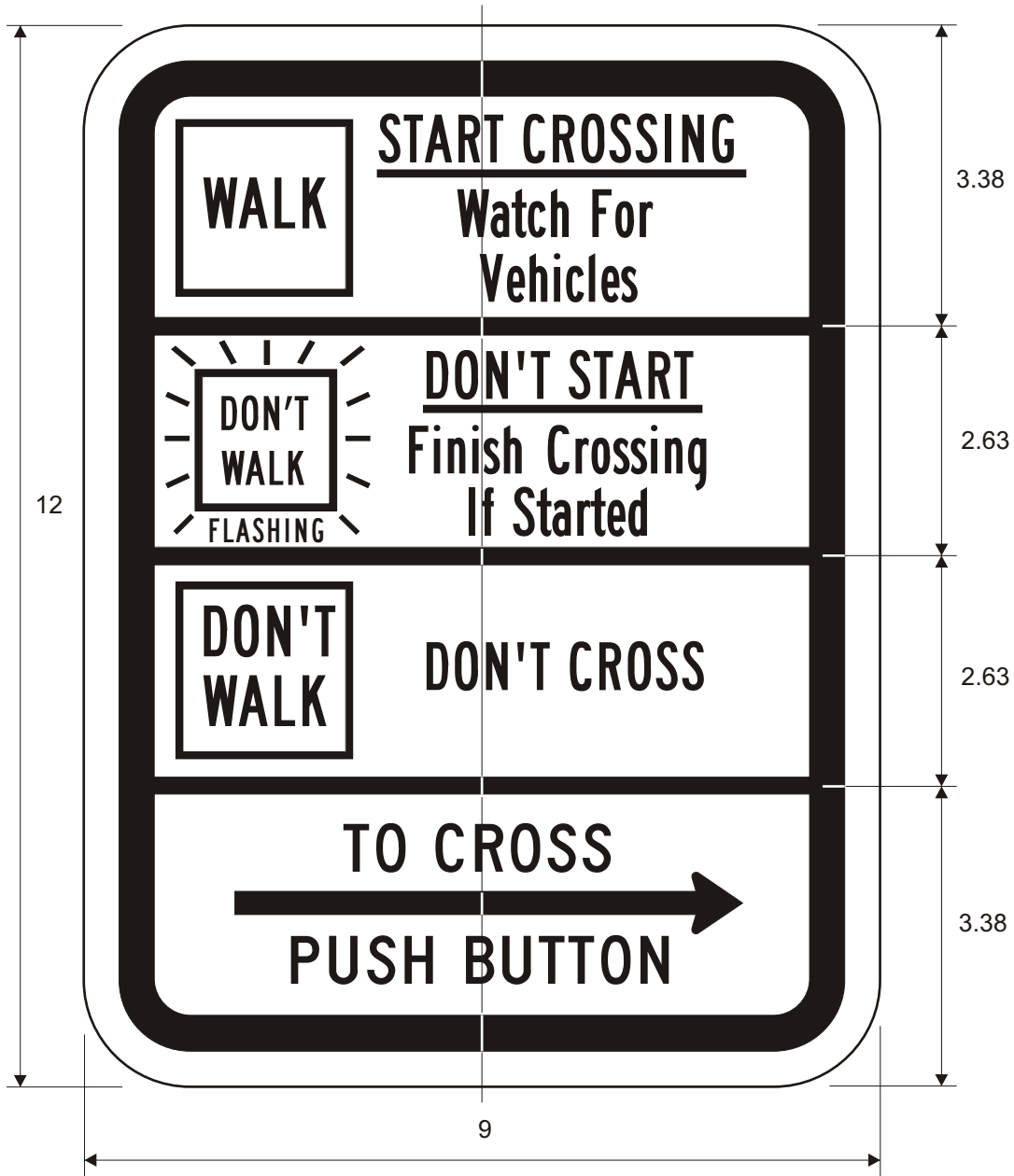

Border and Legend: Black
Background: White
Don't Walk: Orange

R10-3D

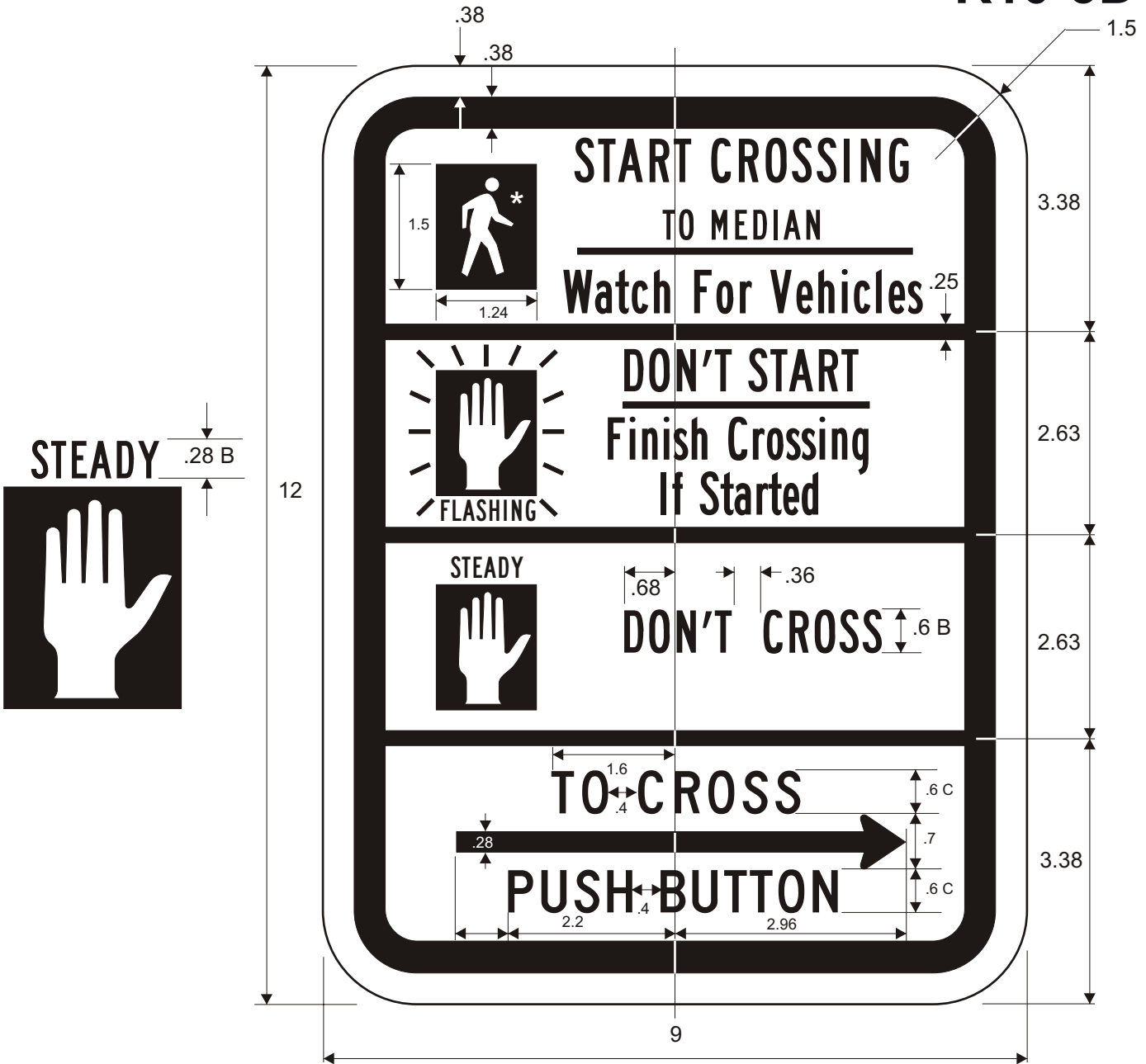

Legend and Border: Black
 Background: White
 Hand Symbol: Orange

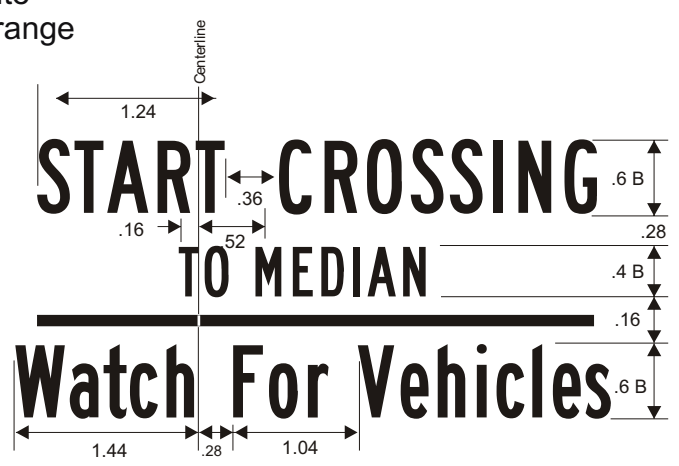
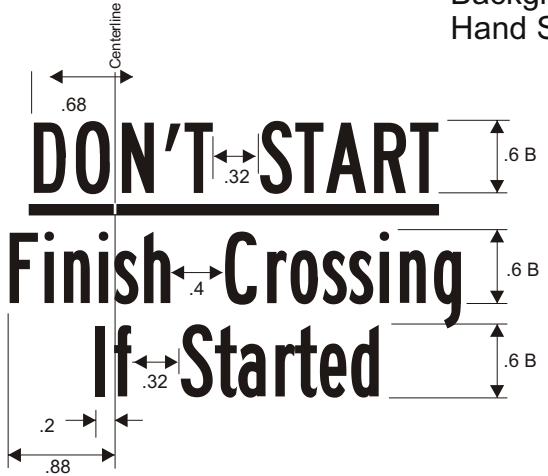

R10-3E

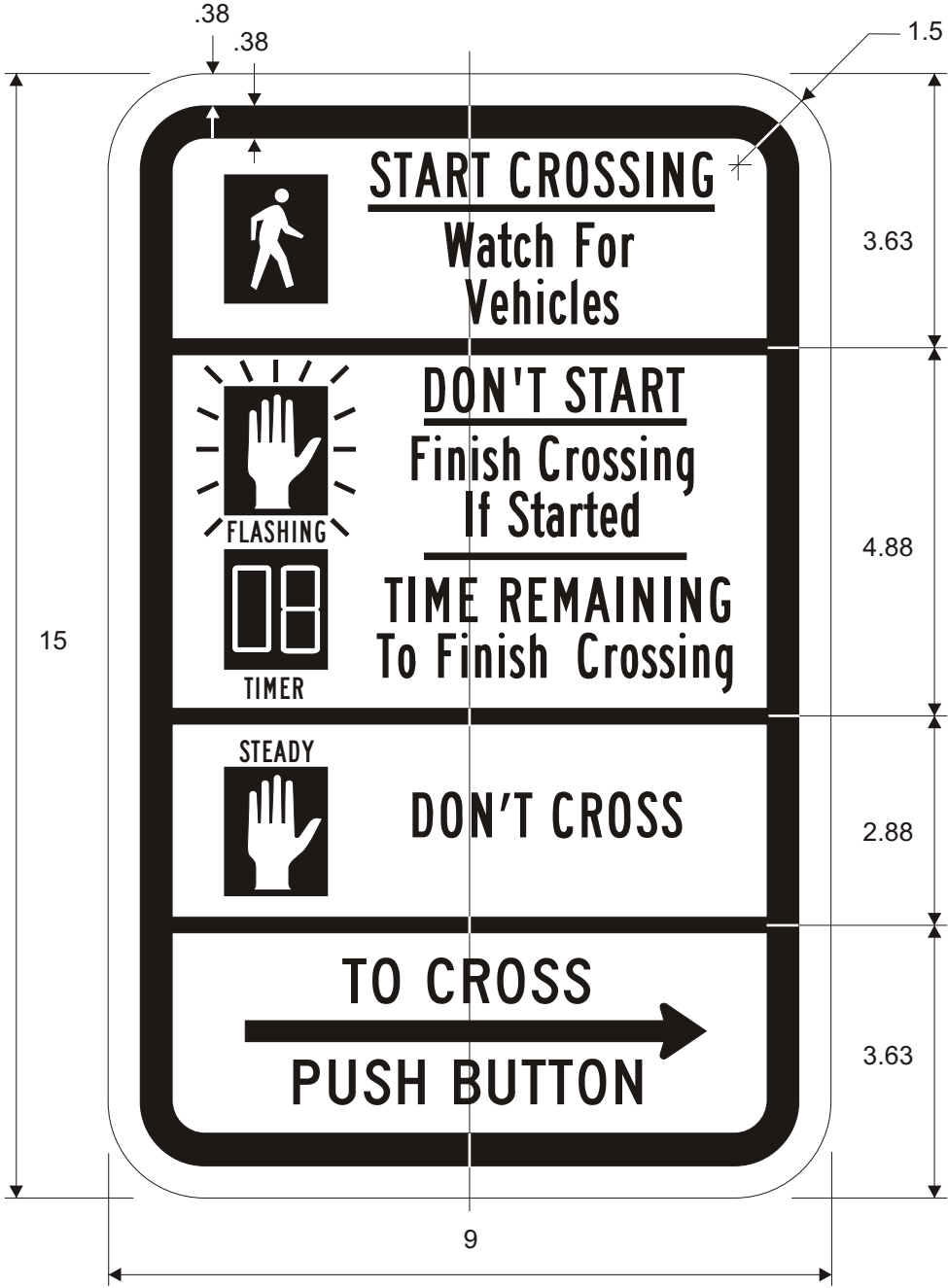

Legend and Border: Black
 Background: White
 08 and Hand Symbol: Orange

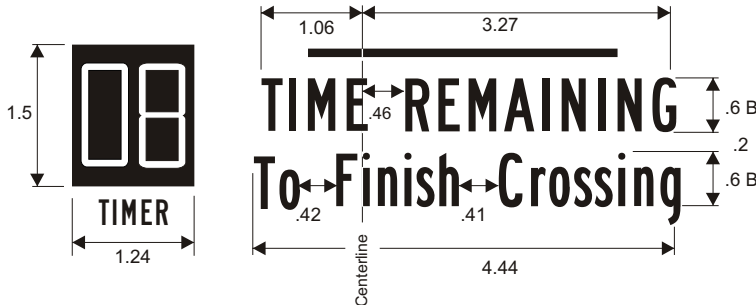

R10-4A

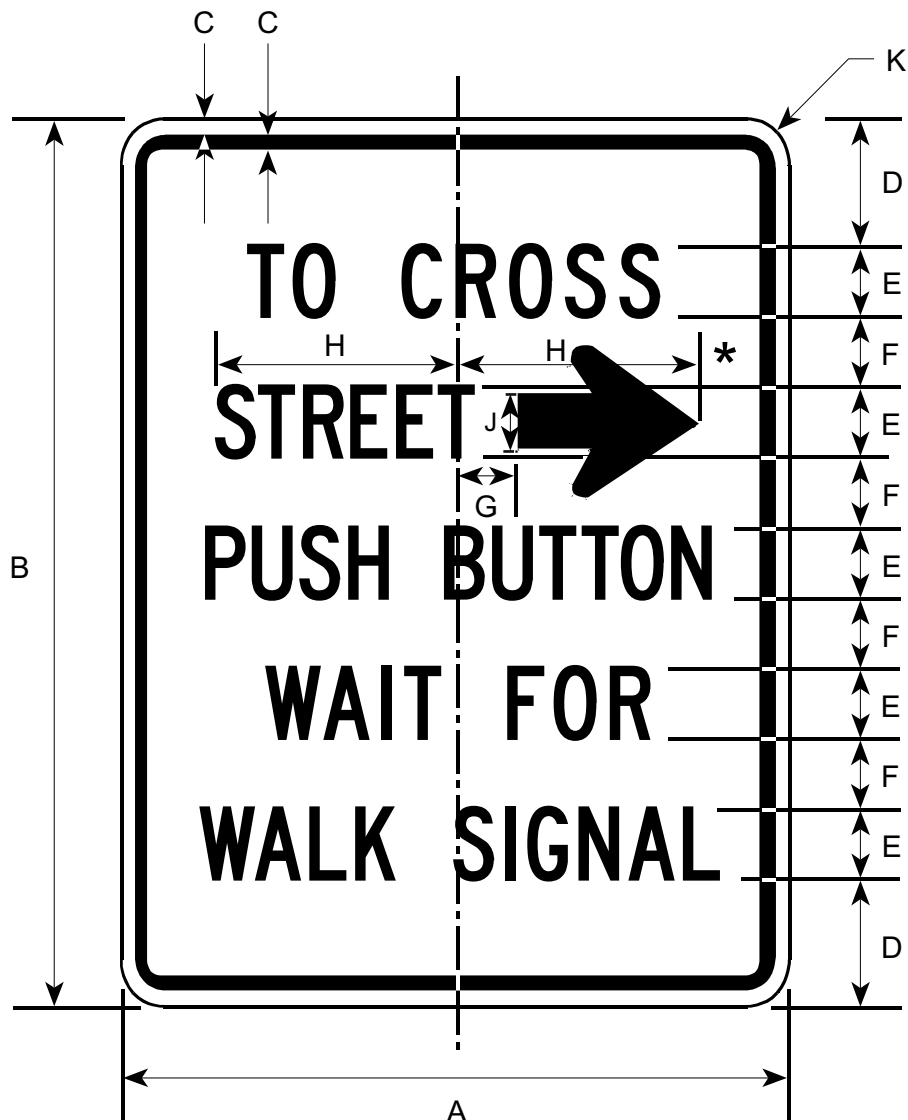

Border and Legend: Black
Background: White

*See Appendix B-1 for Standard Arrow Details.

Road Class	Dimensions (inches)									
	A	B	C	D	E	F	G	H	J	K
Conv & Min	9	12	0.38	1.5	1C	1.0	0.5	3.25	0.75	1.5

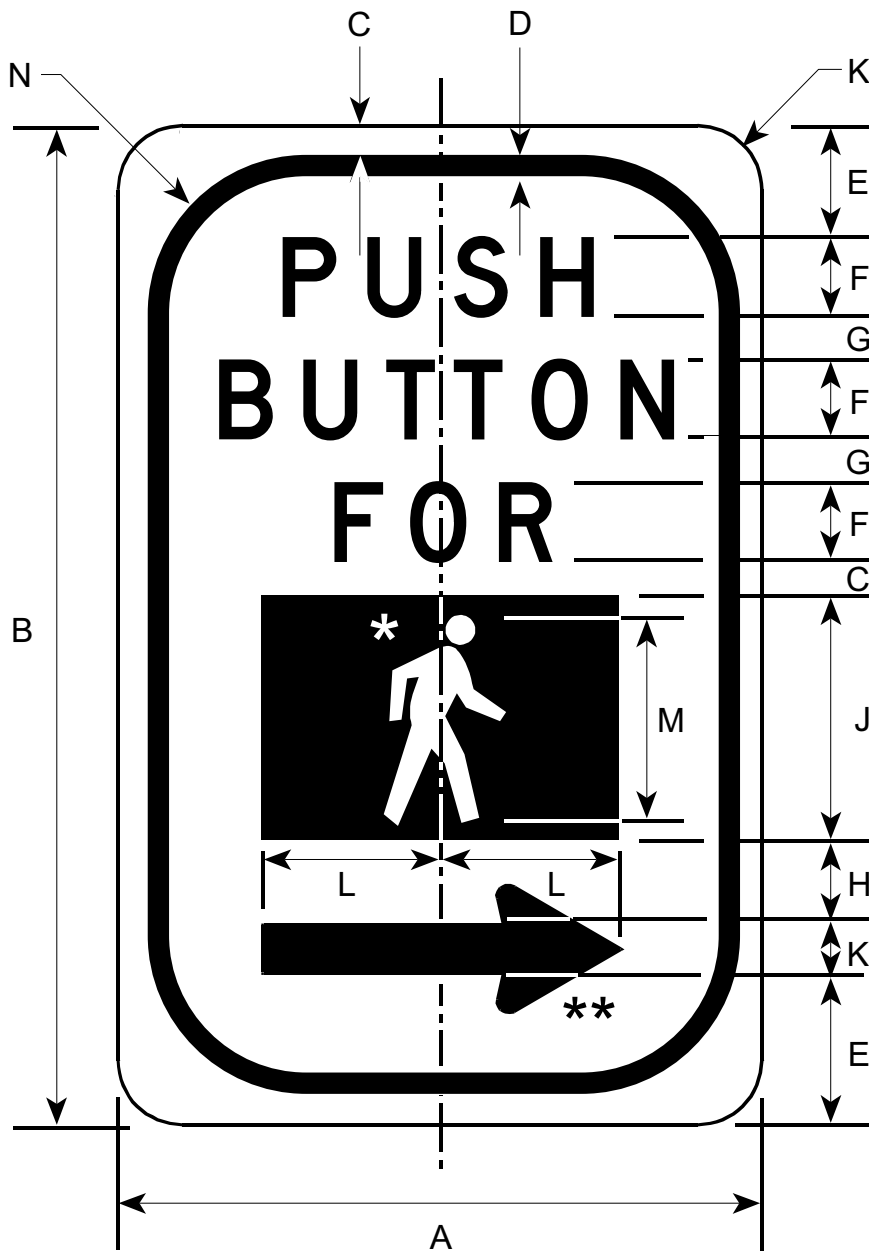

Border and Legend: Black
Background: White

Right side version shown. Reverse the arrow when the street is to the left.

* Make symbol proportional to the one shown.

** See Appendix B-1 for Standard Arrow Details.

Road Class	Dimensions (inches)												
	A	B	C	D	E	F	G	H	J	K	L	M	N
Conv & Min	5	8	0.25	0.88	1.13	0.63D	0.31	0.63	1.88	0.5	1.25	1.5	1



Border and Legend: Black
Background: White

Prior to the 2002 publication of this manual, this sign was numbered R10-5A.

Road Class	Dimensions (inches)								
	A	B	C	D	E	F	G	H	I
Minimum	18	24	0.38	0.63	3.00	3C	2.00	3D	1.50
Conventional	24	30	0.38	0.63	3.25	4C	2.50	4D	1.50
Expressway	30	36	0.50	0.75	4.25	5C	2.50	5D	1.88

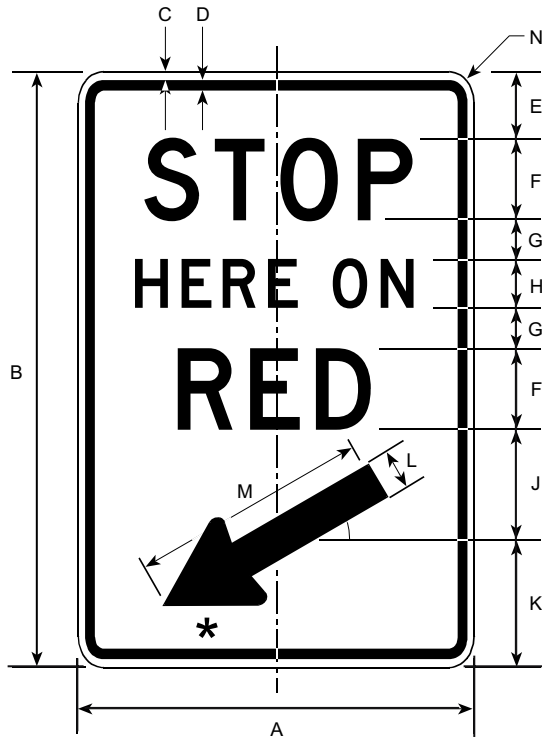

R10-6L



R10-6R

Border and Legend: Black
Background: White

*See Appendix B-1 for Standard Arrow Details.

Road Class	Dimensions (inches)												
	A	B	C	D	E	F	G	H	J	K	L	M	N
Conv & Min	24	36	0.38	0.63	4	5D	2.5	3D	6.5	7.5	2.63	14.63	1.5

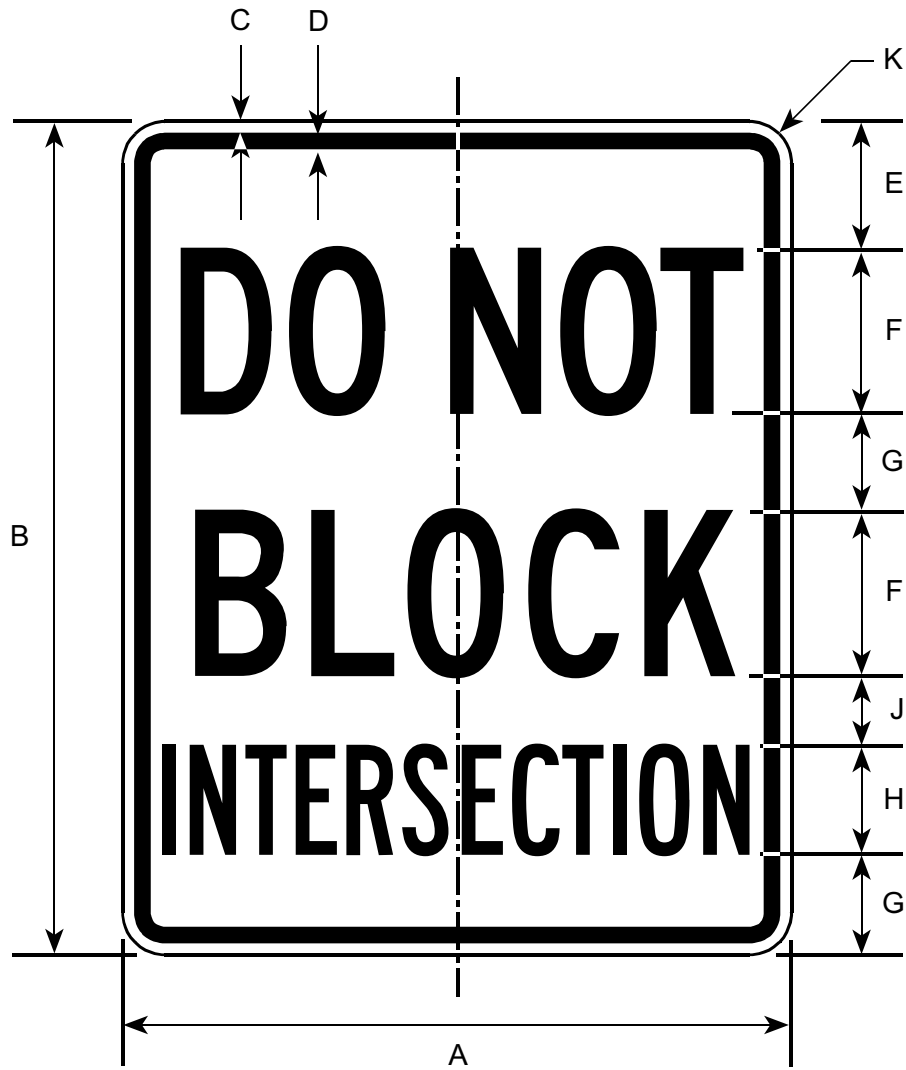

Border and Legend: Black
Background: White

Road Class	Dimensions (inches)									
	A	B	C	D	E	F	G	H	J	K
Conv & Min	24	30	0.38	0.63	4.5	6C	3.5	4B	2.5	1.5

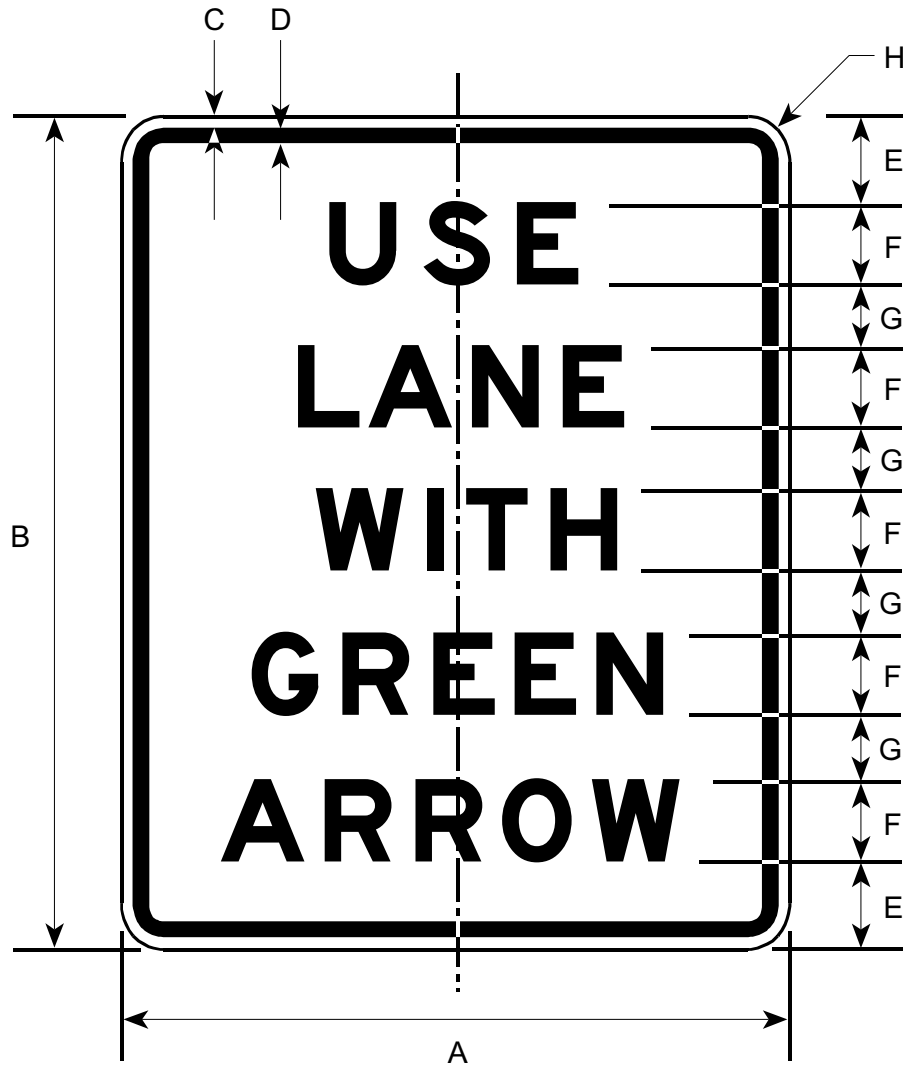

Border and Legend: Black
Background: White

Road Class	Dimensions (inches)							
	A	B	C	D	E	F	G	H
Minimum	18	24	0.38	0.63	3	2E	2.00	1.50
Conventional	24	30	0.38	0.63	3	3E	2.25	1.50
Expressway	30	36	0.50	0.75	3	4E	2.50	1.88

R10-10

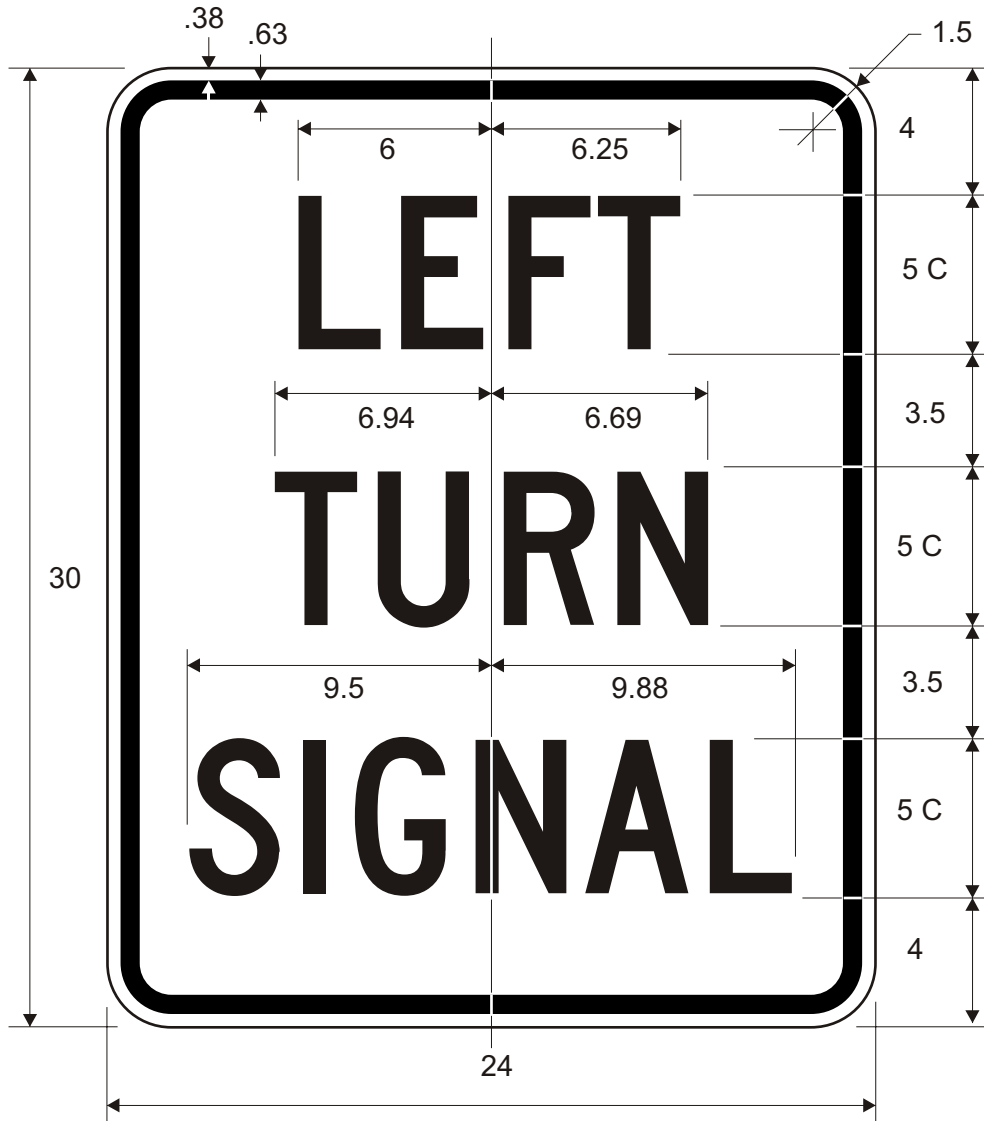

R10-10L



R10-10R



Legend and Border: Black
Background: White

R10-11A

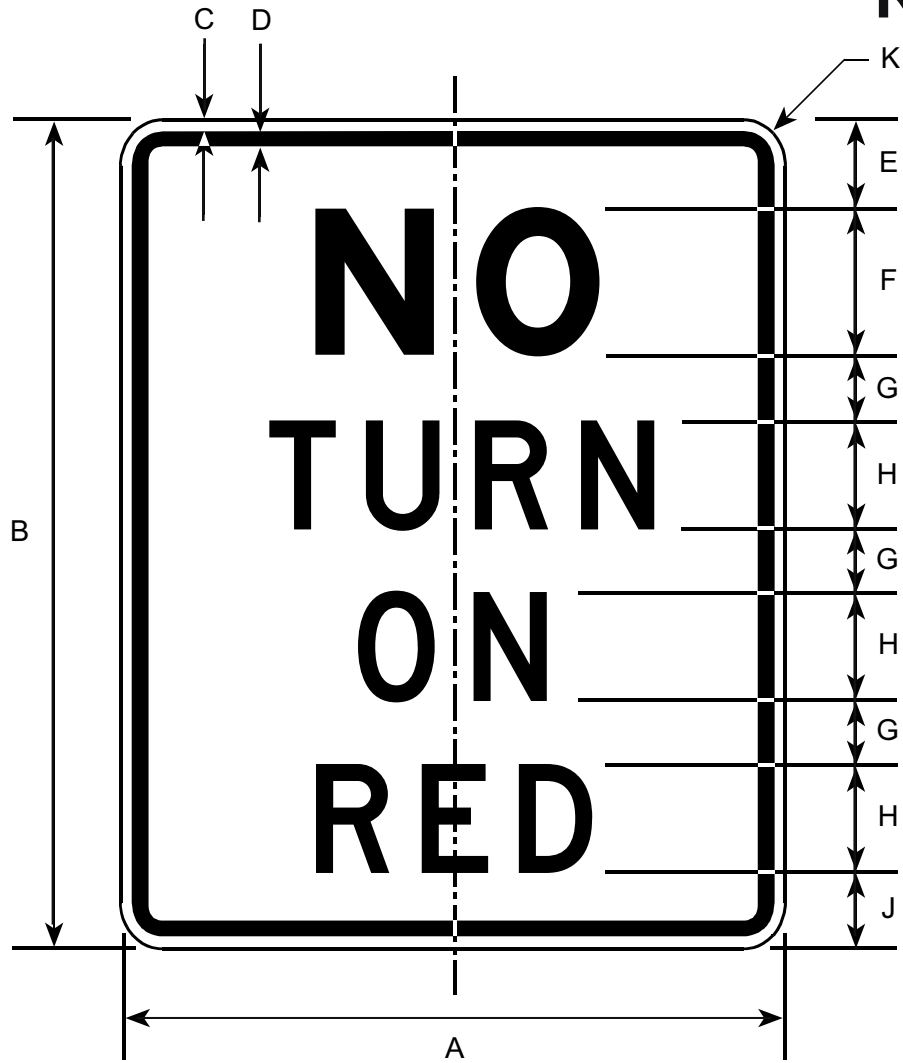

Border and Legend: Black
Background: White

Road Class	Dimensions (inches)									
	A	B	C	D	E	F	G	H	J	K
Minimum	18	24	0.38	0.63	3	4E	1.75	3D	2.75	1.50
Conventional	24	30	0.38	0.63	3	5E	2.25	4D	3.00	1.50
Oversized	36	48	0.63	0.88	6	8E	3.50	6D	5.50	2.25

R10-11B

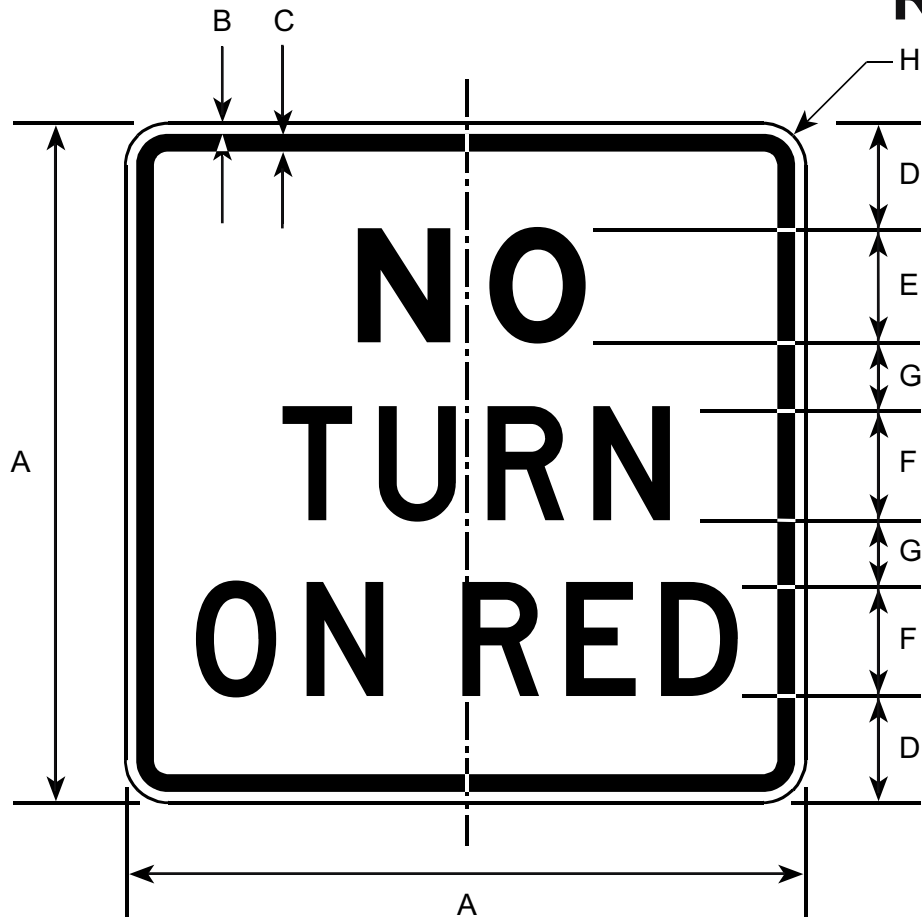

Border and Legend: Black
Background: White

Road Class	Dimensions (inches)							
	A	B	C	D	E	F	G	H
Minimum	18	0.38	0.63	2.75	3E	3D	1.75	1.50
Conventional	24	0.38	0.63	3.50	4E	4D	2.50	1.50
Oversized	30	0.50	0.75	4.50	5E	5D	3.00	1.88

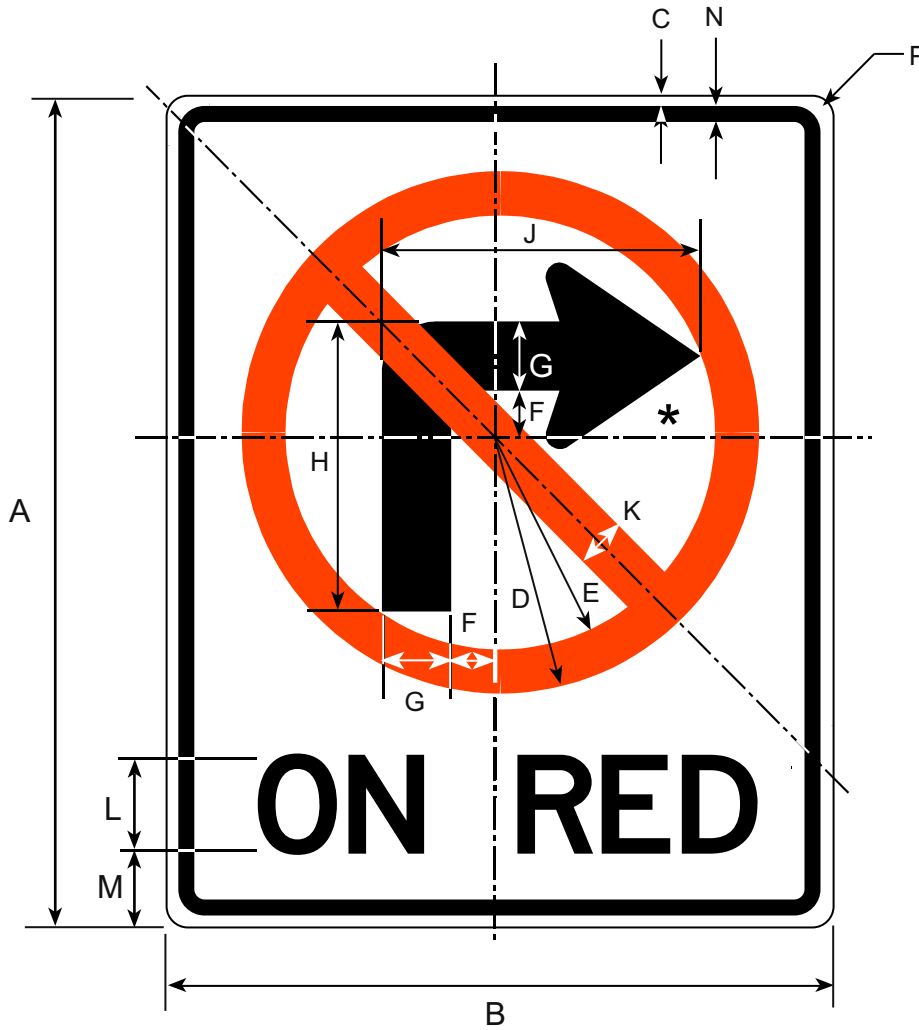

Circle, Diagonal: Red
 Arrow, Border, Legend: Black
 Background: White

*See Appendix B-1 for Standard Arrow Details.

Road Class	Dimensions (inches)														
	A	B	C	D	E	F	G	H	J	K	L	M	N	P	
Conv & Min	24	30	0.38	10.5	8.5	1.5	2.5	10.5	11.5	2.0	4D	3.5	0.63	1.5	
Expressway	30	36	0.50	13.13	10.63	1.88	3.13	13.13	14.5	2.5	5D	4.0	0.75	1.88	

R10-11D

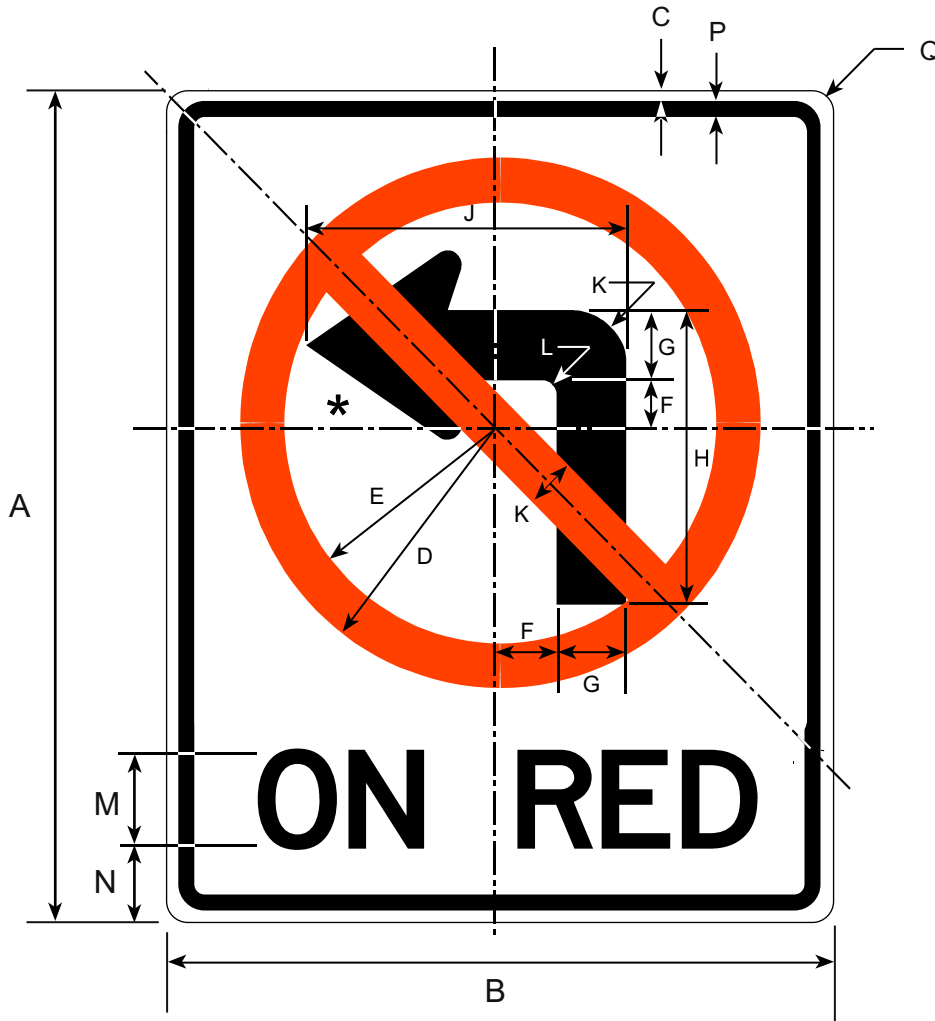

Circle, Diagonal: Red
 Arrow, Border, Legend: Black
 Background: White

*See Appendix B-1 for Standard Arrow Details.

Road Class	Dimensions (inches)															
	A	B	C	D	E	F	G	H	J	K	L	M	N	P	Q	
Conv & Min	24	30	0.38	10.5	8.5	1.5	2.5	10.5	11.5	2.0	0.50	4D	3.5	0.63	1.5	
Expressway	30	36	0.50	13.13	10.63	1.88	3.13	13.13	14.5	2.5	0.63	5D	4.0	0.75	1.88	

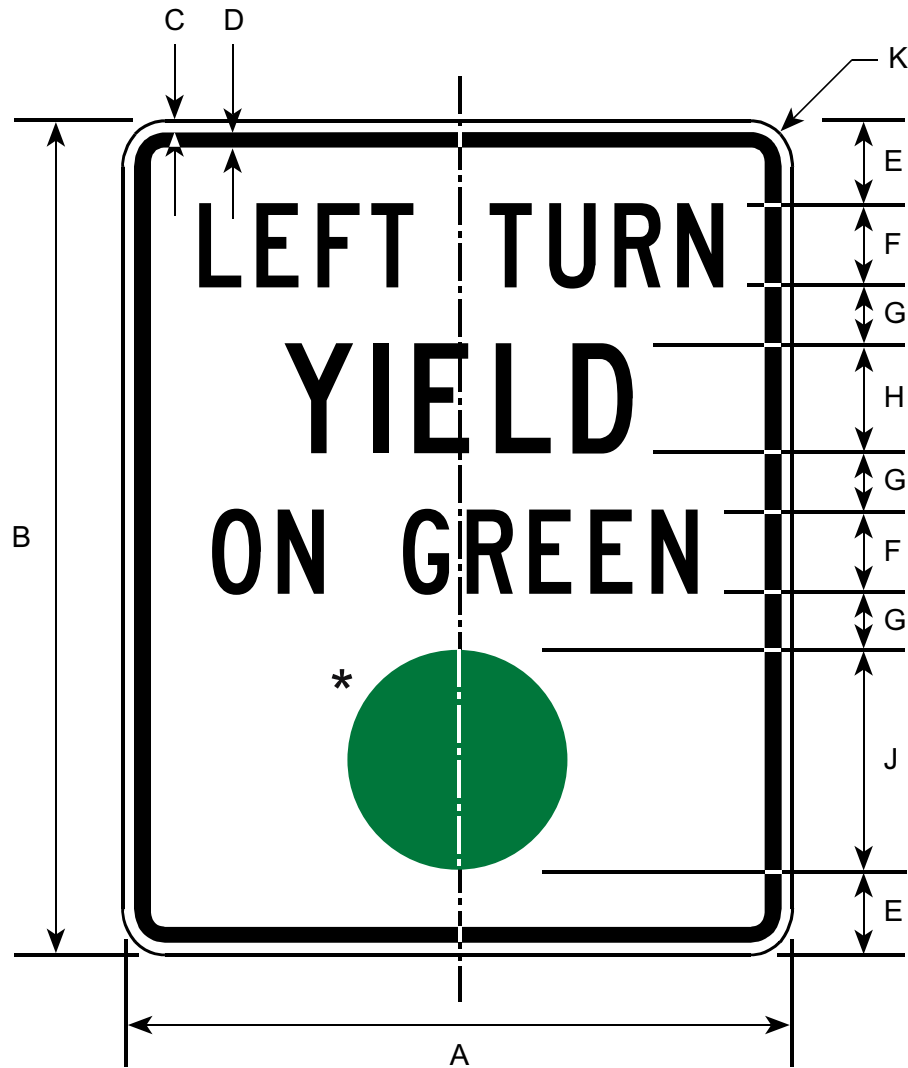

Border and Legend: Black
 Background: White
 Ball: Green

* Make symbol proportional to the one shown.

Road Class	Dimensions (inches)									
	A	B	C	D	E	F	G	H	J	K
Minimum	24	30	0.38	0.63	3	3C	2.0	4C	8	1.5
Conventional	30	36	0.50	0.75	3	4C	2.5	5C	9	2.0

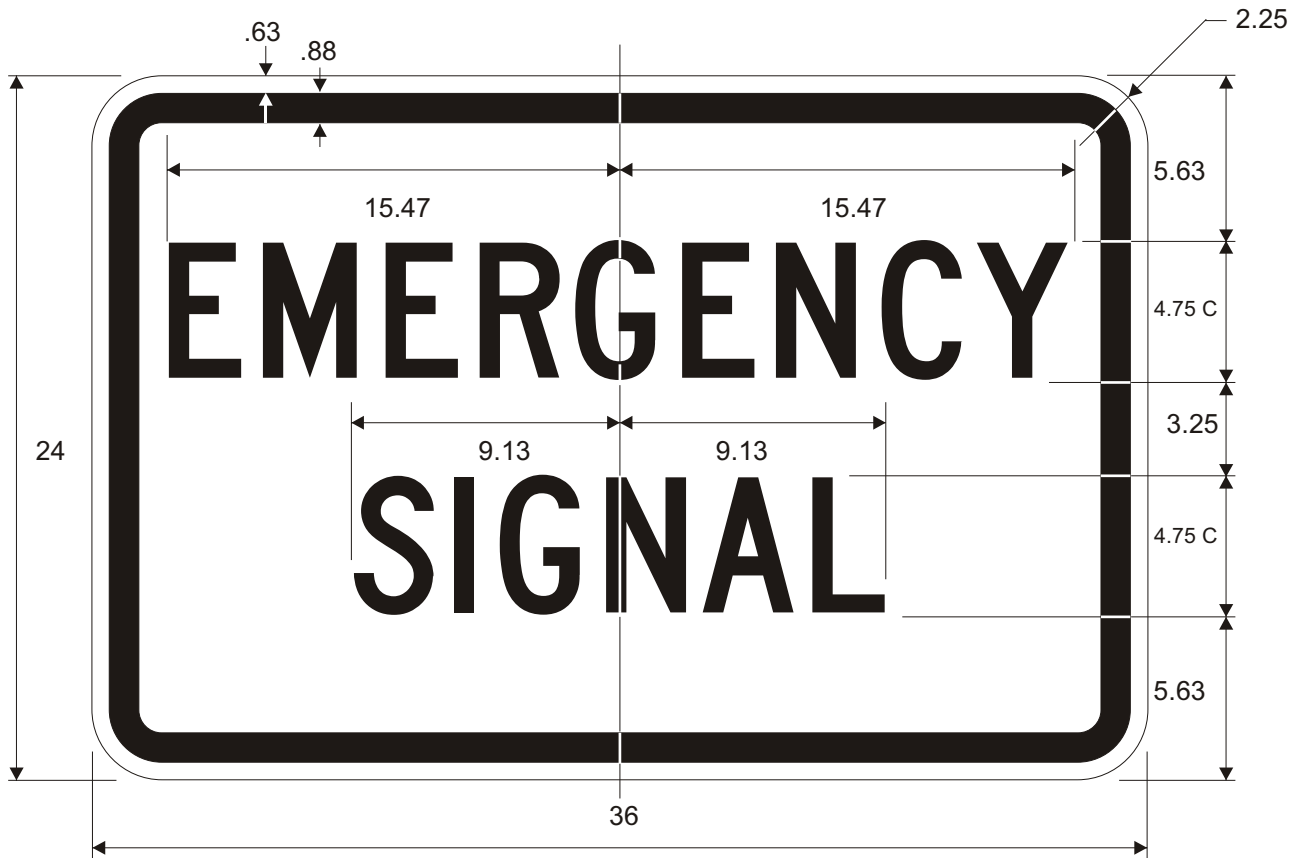

Legend and Border: Black
Background: White



Legend and Border: Black
Background: White

Road Class	Dimensions (inches)													
	A	B	C	D	E	F	G	H	J	K	L	M	N	P
Min.	24	30	0.38	0.63	4.25	2.5D	2.0	3.5D	6.76	6.39	5.67	7.17	10.53	1.5
Conv.	30	36	0.50	0.50	4.5	3D	2.75	4D	8.12	7.67	6.48	8.60	12.64	1.88
Oversized	36	42	0.63	0.88	5.75	3.5D	3.0	4.5D	9.47	8.943	7.29	10.04	14.74	2.25

R10-16

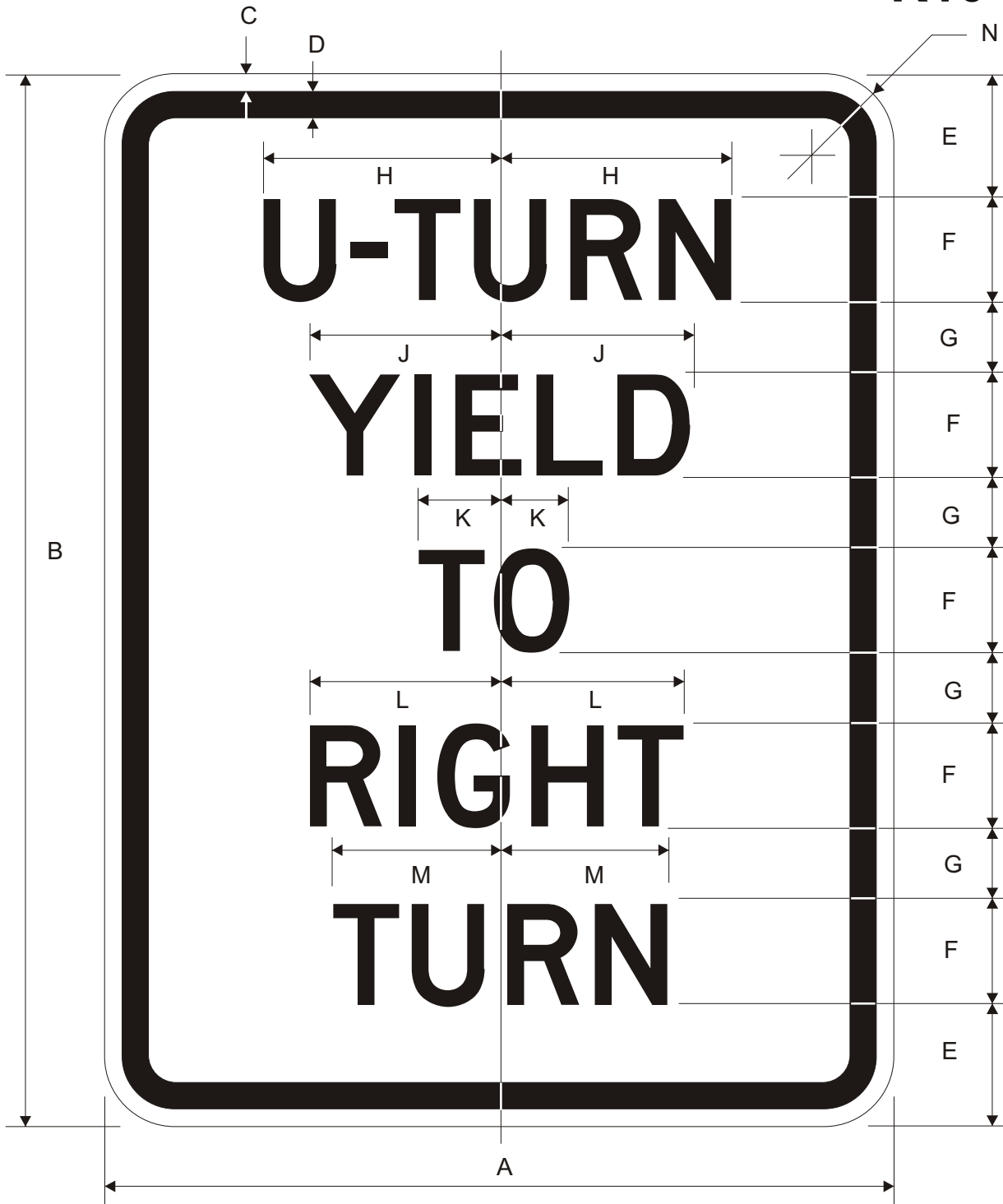

Legend and Border: Black
Background: White

Road Class	Dimensions (inches)												
	A	B	C	D	E	F	G	H	J	K	L	M	N
Conv.	30	36	0.5	0.75	3	4D	2.5	8.89	7.31	2.90	7.13	6.41	1.88

R10-20A

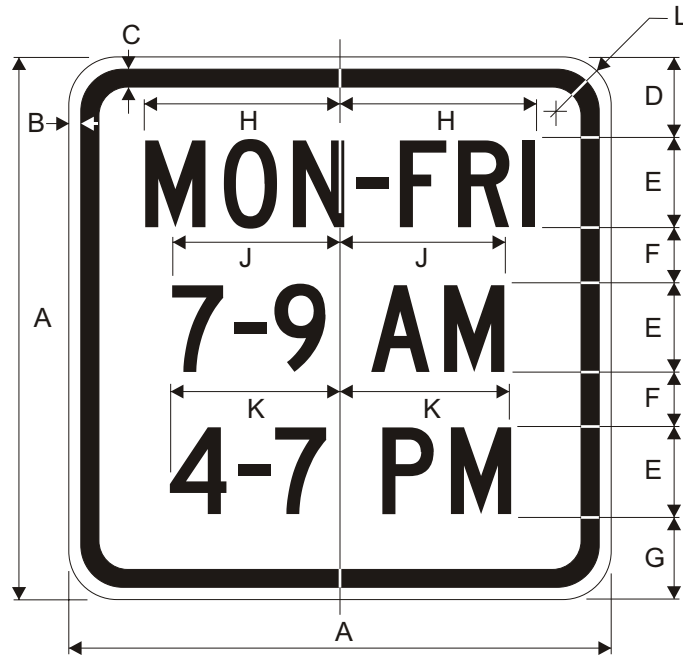

R10-20a

Road Class	Dimensions (inches)										
	A	B	C	D	E	F	G	H	J	K	L
Conv.	24	0.38	0.63	3.5	4C	2.5	3.5	8.69	7.41	7.53	1.5
Expy.	30	0.5	0.75	4.5	5C	3.0	4.5	10.85	9.24	9.39	1.88
Oversized	48	0.75	1.25	7.0	8C	5.0	7.0	17.37	14.79	15.03	3.0

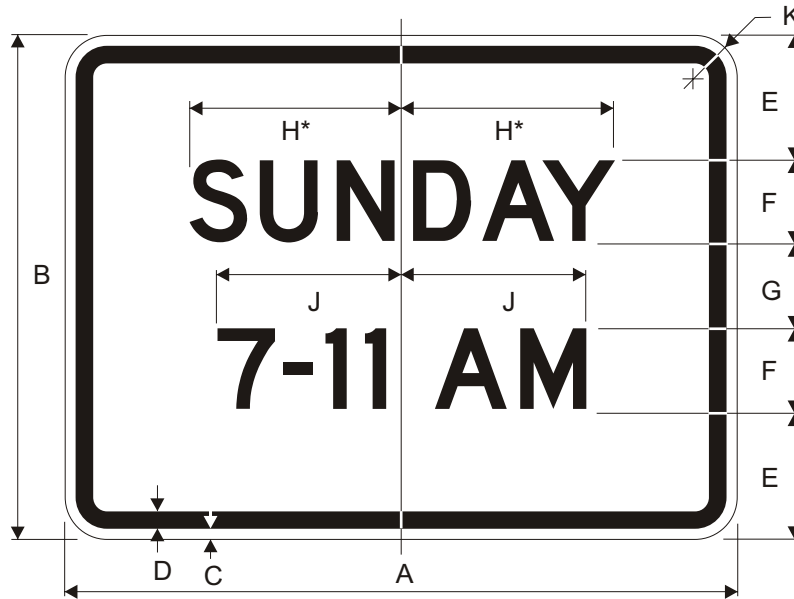

R10-20a

Legend and Border: Black
Background: White

*Reduce spacing to fit.

Road Class	Dimensions (inches)										
	A	B	C	D	E	F	G	H	J	K	
Conv.	24	18	0.38	0.63	4.5	3D	3.0	7.59	6.59	1.5	
Expy.	30	24	0.50	0.75	6.0	4D	4.0	10.11	8.79	1.88	
Oversized	48	36	0.75	1.25	9.0	6D	6.0	15.8	13.18	3.0	

R10-22

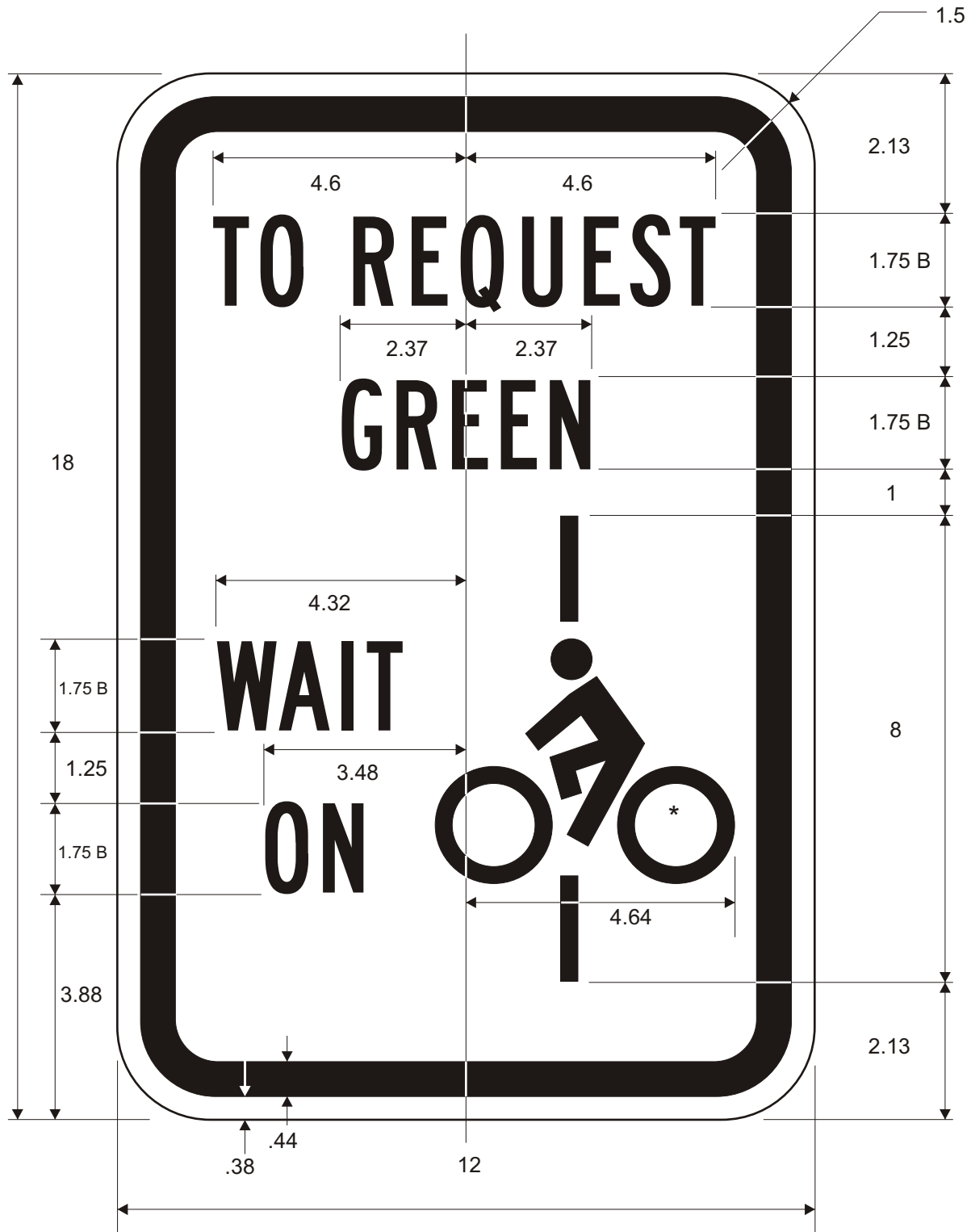

*Make symbol proportional to sign drawing.

Legend and Border: Black
Background: White

R10-100

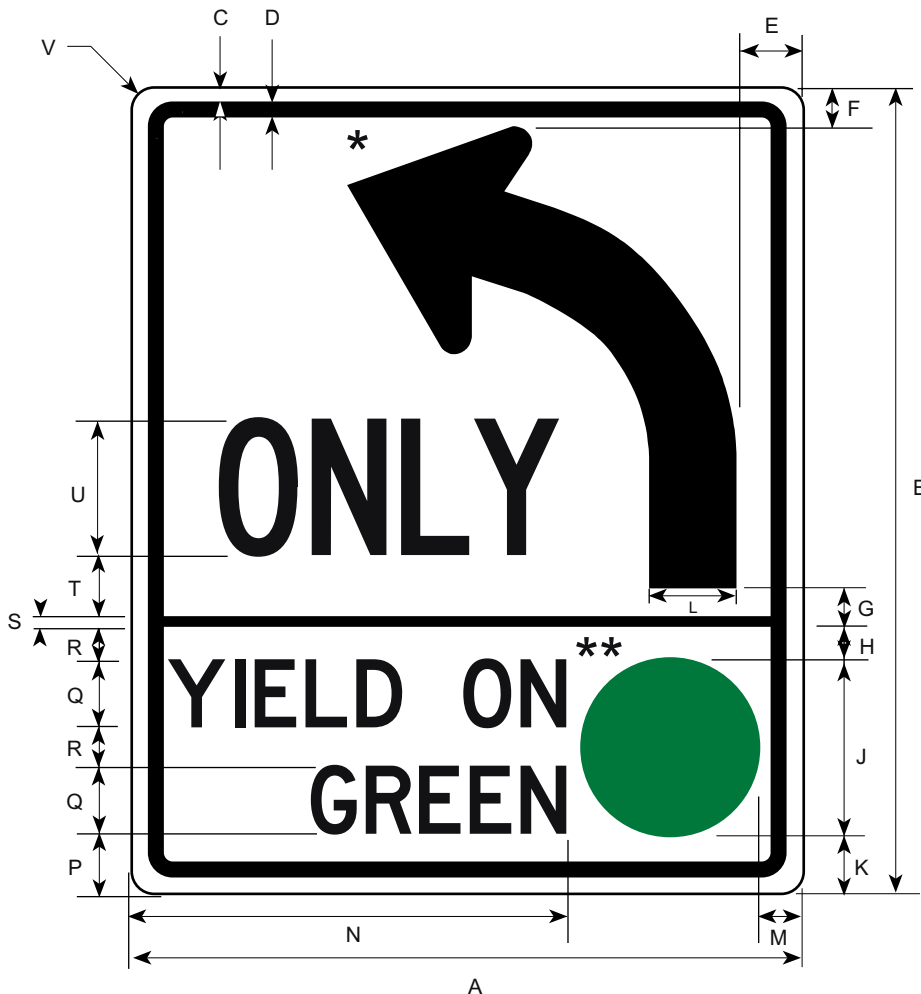

Border and Legend: Black
 Ball: Green
 Background: White

* See R3-5L for arrow details

** Make symbol proportional to the one shown.

Prior to the 2002 publication of this manual this sign was numbered R10-13, however that sign did not include the word "GREEN".

Road Class	Dimensions (inches)																			
	A	B	C	D	E	F	G	H	J	K	L	M	N	P	Q	R	S	T	U	V
Conv & Mir	30	36	0.5	0.75	3	1.75	3.25	1.5	8	2.25	3.75	2	19	2.75	3D	1.5	0.5	2.75	6C	1.88

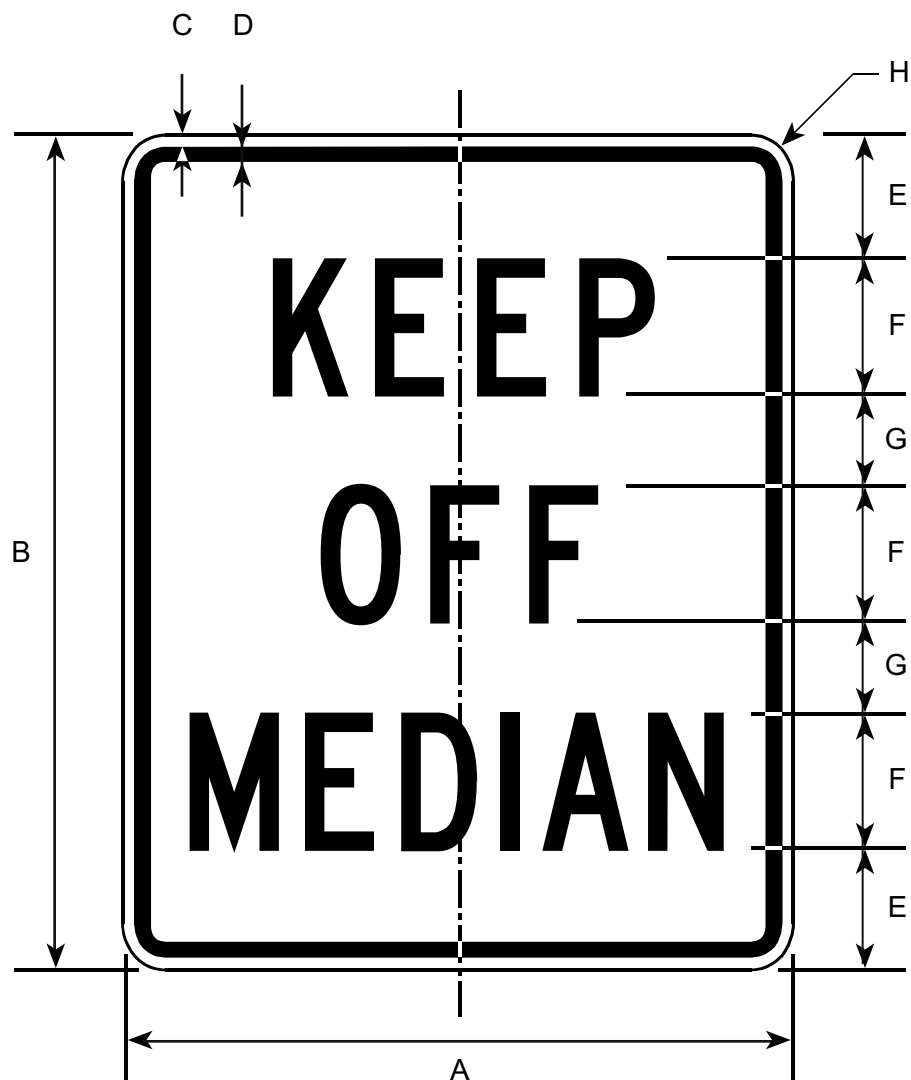

Border and Legend: Black
Background: White

Road Class	Dimensions (inches)							
	A	B	C	D	E	F	G	H
Conv & Min	24	30	0.38	0.63	4.25	5C	3.25	1.50
Expressway	36	48	0.63	0.88	6.75	8C	5.25	2.25
Freeway	48	60	0.75	1.25	8.50	10C	6.50	3.00

R11-2



Border and Legend: Black
Background: White

Road Class	Dimensions (inches)							
	A	B	C	D	E	F	G	H
Conv & Min	48	30	0.50	0.75	5	8D	4	1.88

R11-3

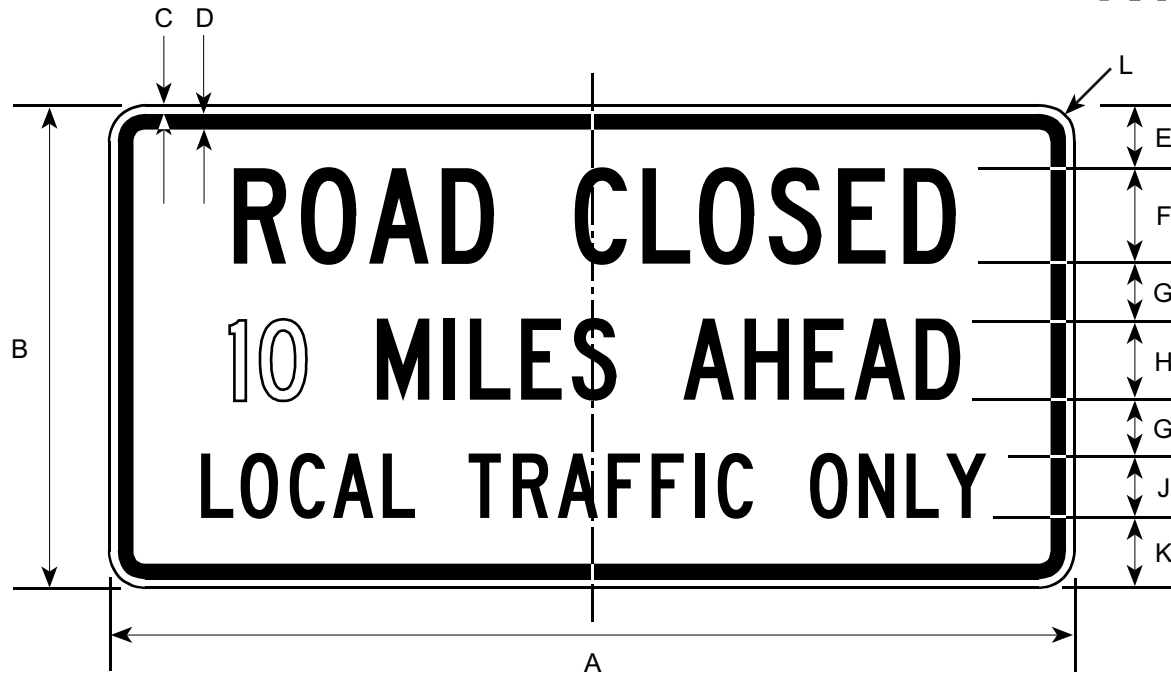

Border and Legend: Black
Background: White

Prior to the 2002 publication of this manual,
this sign was numbered R11-3A.

Road Class	Dimensions (inches)										
	A	B	C	D	E	F	G	H	J	K	L
Conv & Min	60	30	0.5	0.75	4	6C	3.38	5C	4C	4.25	1.88

R11-3A

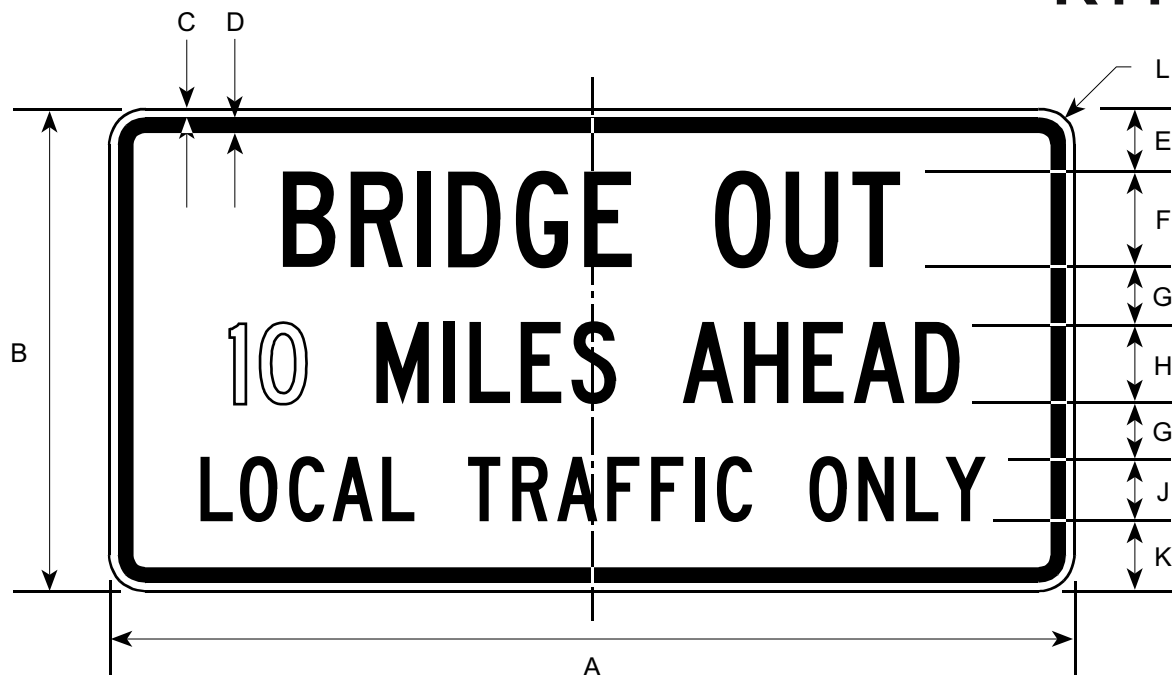

Border and Legend: Black
Background: White

Prior to the 2002 publication of this manual,
this sign was numbered R11-3B.

Road Class	Dimensions (inches)										
	A	B	C	D	E	F	G	H	J	K	L
Conv & Min	60	30	0.50	0.75	4	6C	3.38	5C	4C	4.25	1.88

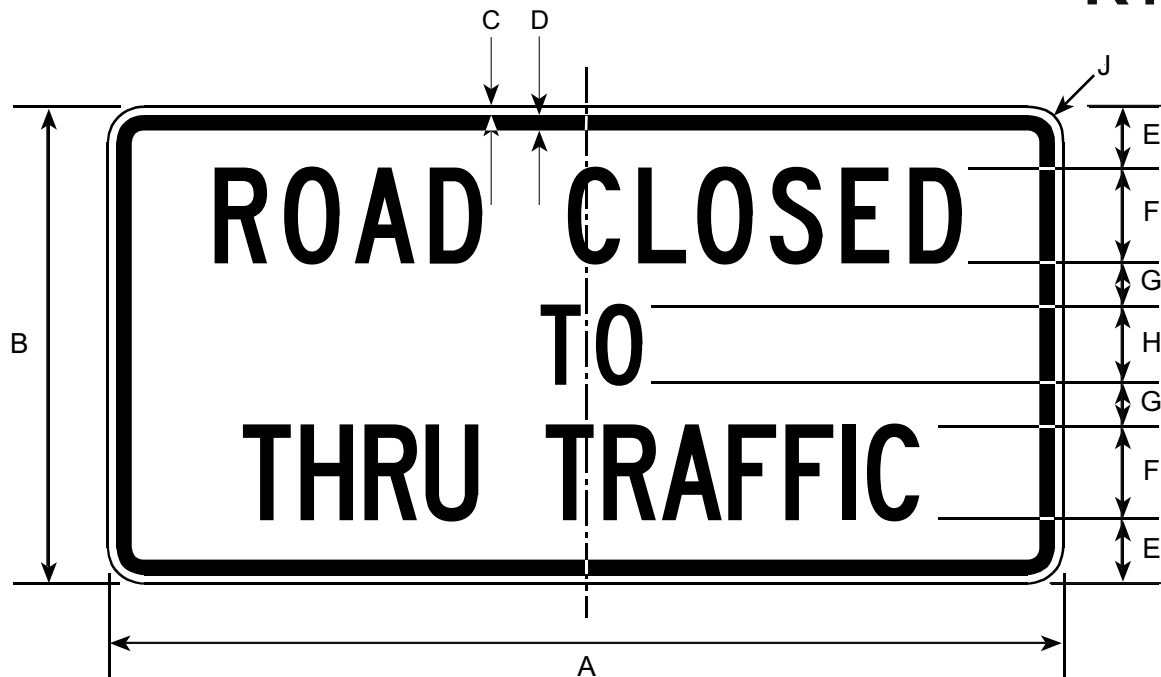

Border and Legend: Black
 Background: White

Road Class	Dimensions (inches)								
	A	B	C	D	E	F	G	H	J
Conv & Min	60	30	0.5	0.75	4	6C	2.5	5C	1.88



Border and Legend: Black
Background: White

Prior to the 2002 publication of this manual,
this sign was numbered R11-5.

Road Class	Dimensions (inches)									
	A	B	C	D	E	G	H	J	K	L
Minimum	36	18	3D	2D	3.0	2.0	0.63	1.0	4.75	4.13
Conventional	48	24	4D	2D	4.0	3.0	0.88	1.5	6.19	5.50

M	N	P	Q	S	T	U	V
13.63	13.81	6.25	5.81	0.75	0.94	9.13	1.5
18.38	18.38	8.38	7.75	1.0	1.25	10.25	1.5



Border and Legend: Black
 Background: White

Prior to the 2002 publication of this manual,
 this sign was numbered R11-6.

Road Class	Dimensions (inches)								
	A	B	C	D	E	F	G	H	J
Conv & Min	60	24	0.5	0.75	5	6C	3	5C	1.88

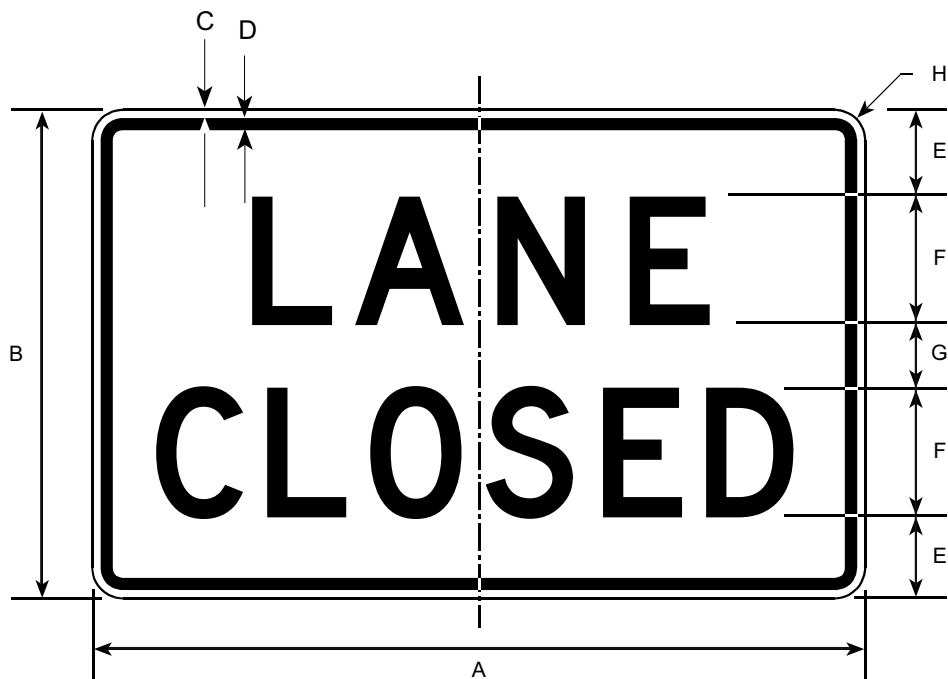

Border and Legend: Black
Background: White

Road Class	Dimensions (inches)							
	A	B	C	D	E	F	G	H
Conv & Min	48	30	0.50	0.75	5	8D	4	1.88

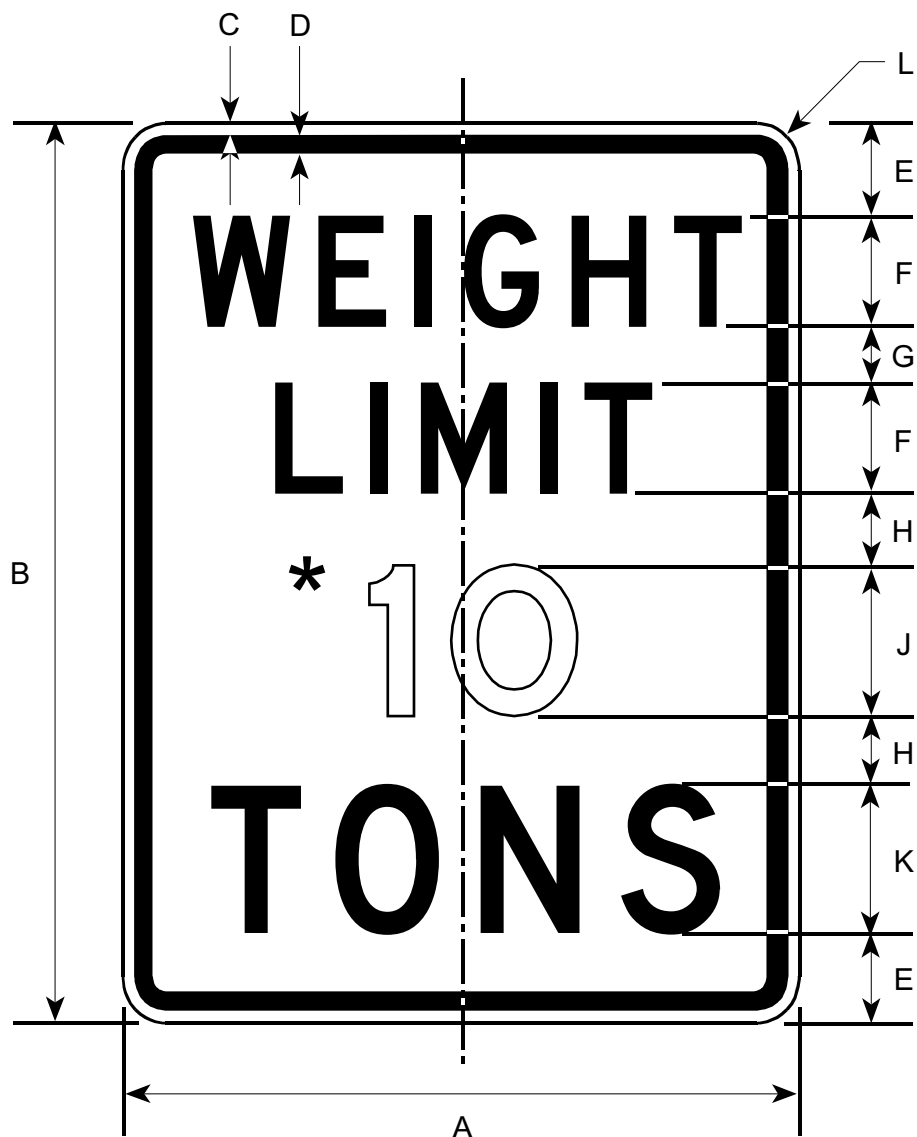

Border and Legend: Black
Background: White

* Optically space numerals
about vertical centerline

Road Class	Dimensions (inches)										
	A	B	C	D	E	F	G	H	J	K	L
Conv & Min	24	30	0.38	0.63	3.00	4D	1.75	2.63	5E	5D	1.50
Expwy & Fwy	36	48	0.63	0.88	4.75	6D	3.00	3.75	8E	8D	2.25

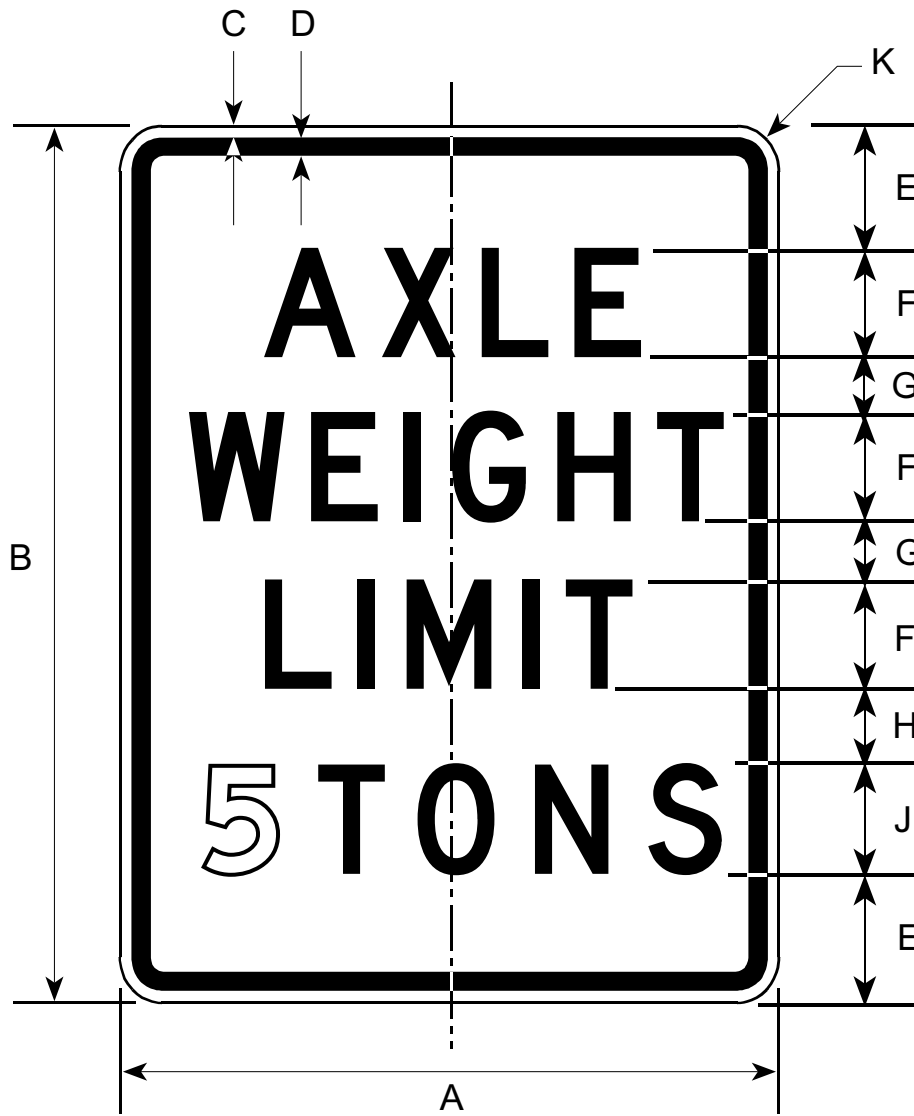

Border and Legend: Black
Background: White

Road Class	Dimensions (inches)									
	A	B	C	D	E	F	G	H	J	K
Conv & Min	24	30	0.38	0.63	3.25	4D	2.00	2.50	5D	1.50
Expwy & Fwy	36	48	0.63	0.88	5.25	6D	3.50	4.50	8D	2.25

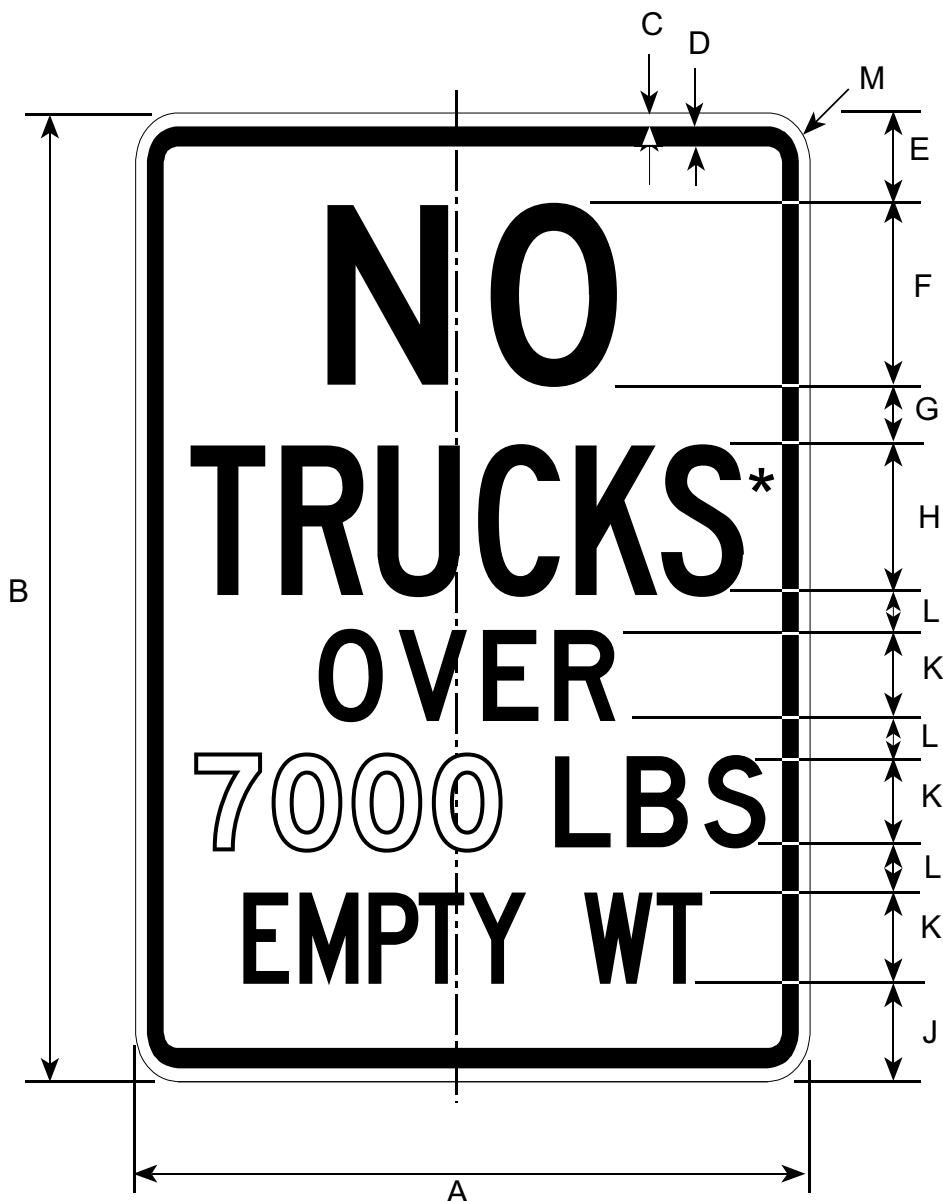

Border and Legend: Black
Background: White

* Reduce spacing 20%

Road Class	Dimensions (inches)											
	A	B	C	D	E	F	G	H	J	K	L	M
Conv & Min	24	36	0.38	0.63	3.50	6D	2.5	5C	4	3D	2	1.5

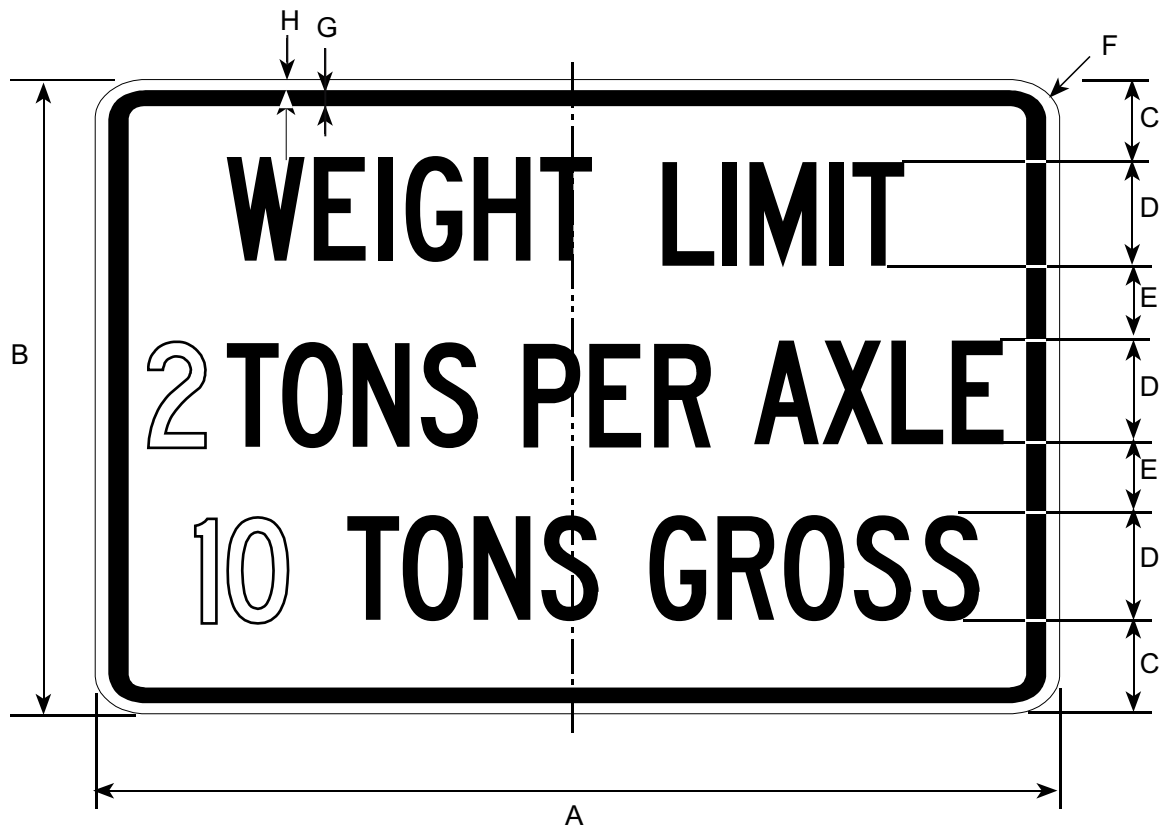

Border and Legend: Black
Background: White

Road Class	Dimensions (inches)							
	A	B	C	D	E	F	G	H
Conv & Min	36	24	3.5	4C	2.5	1.5	0.63	0.38

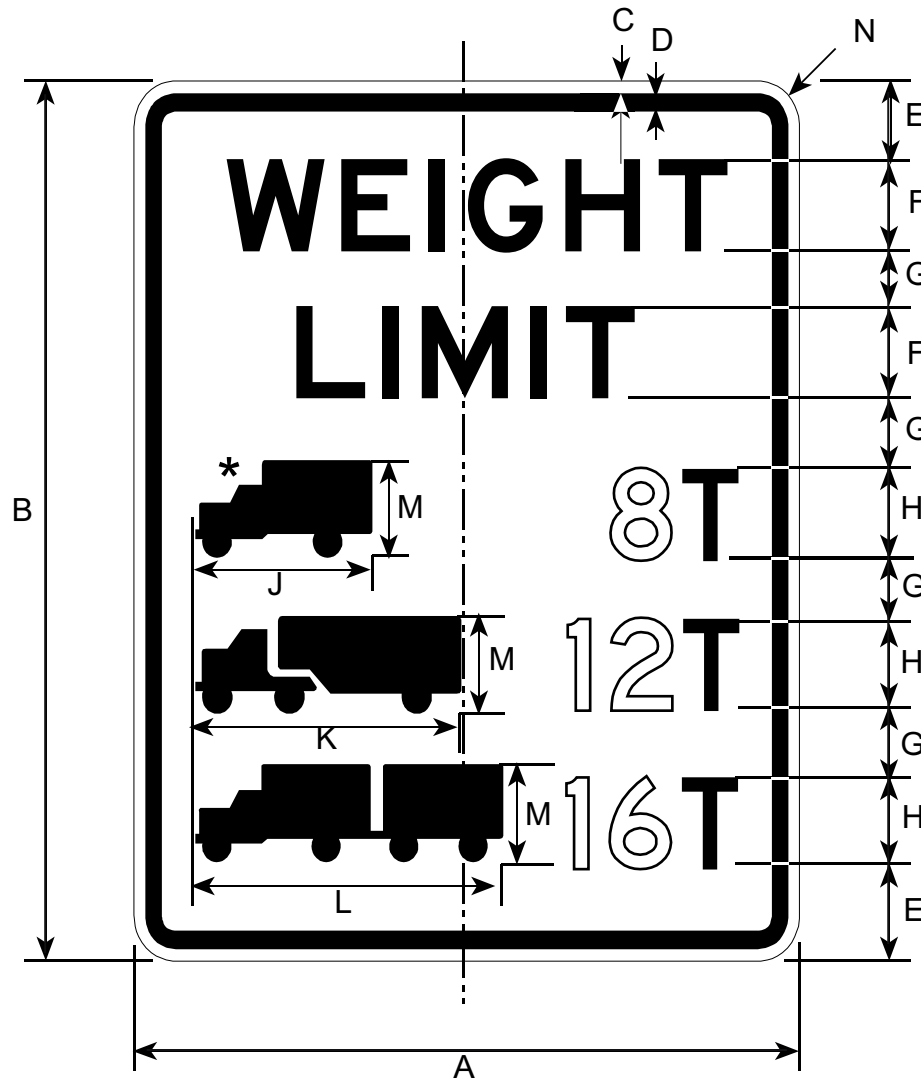

Border and Legend: Black
Background: White

* Make symbol proportional to the one shown.

Road Class	Dimensions (inches)												
	A	B	C	D	E	F	G	H	J	K	L	M	N
Minimum	24	30	0.38	0.63	3.0	3E	2.25	3D	6	9.5	11.00	3	1.50
Conventional	30	36	0.50	0.75	3.5	4E	2.25	4D	8	12.0	14.63	4	1.88
Expressway	36	48	0.63	0.88	5.0	5E	3.25	5D	10	15.0	18.38	5	2.25
Freeway	48	60	0.75	1.25	6.0	6E	4.50	6D	12	18.0	22.00	6	3.00

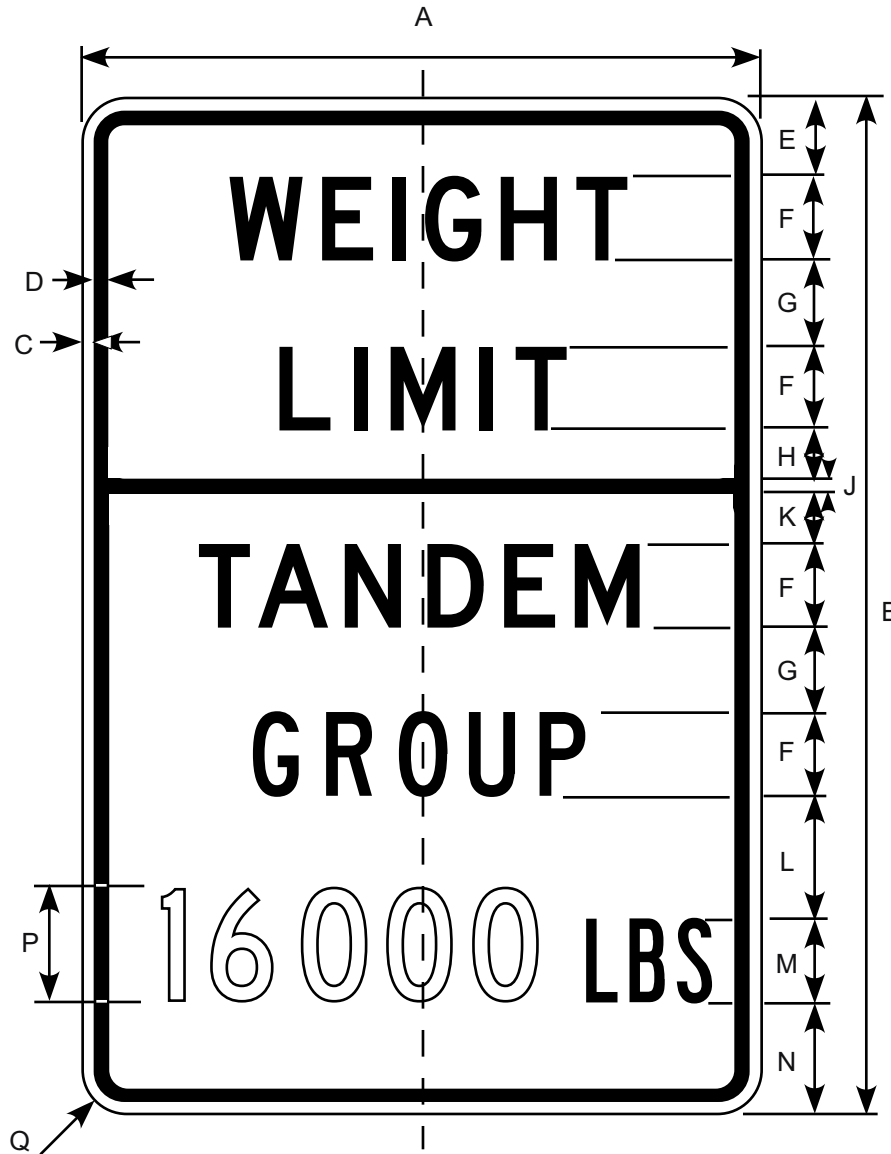

Border and Legend: Black
Background: White

Prior to the 2002 publication of this manual,
this sign was numbered R12-5A.

Road Class	Dimensions (inches)														
	A	B	C	D	E	F	G	H	J	K	L	M	N	P	Q
Conv & Min	24	36	0.38	0.63	2.75	3C	3	1.69	0.63	1.69	4.13	3B	4.13	4C	1.5

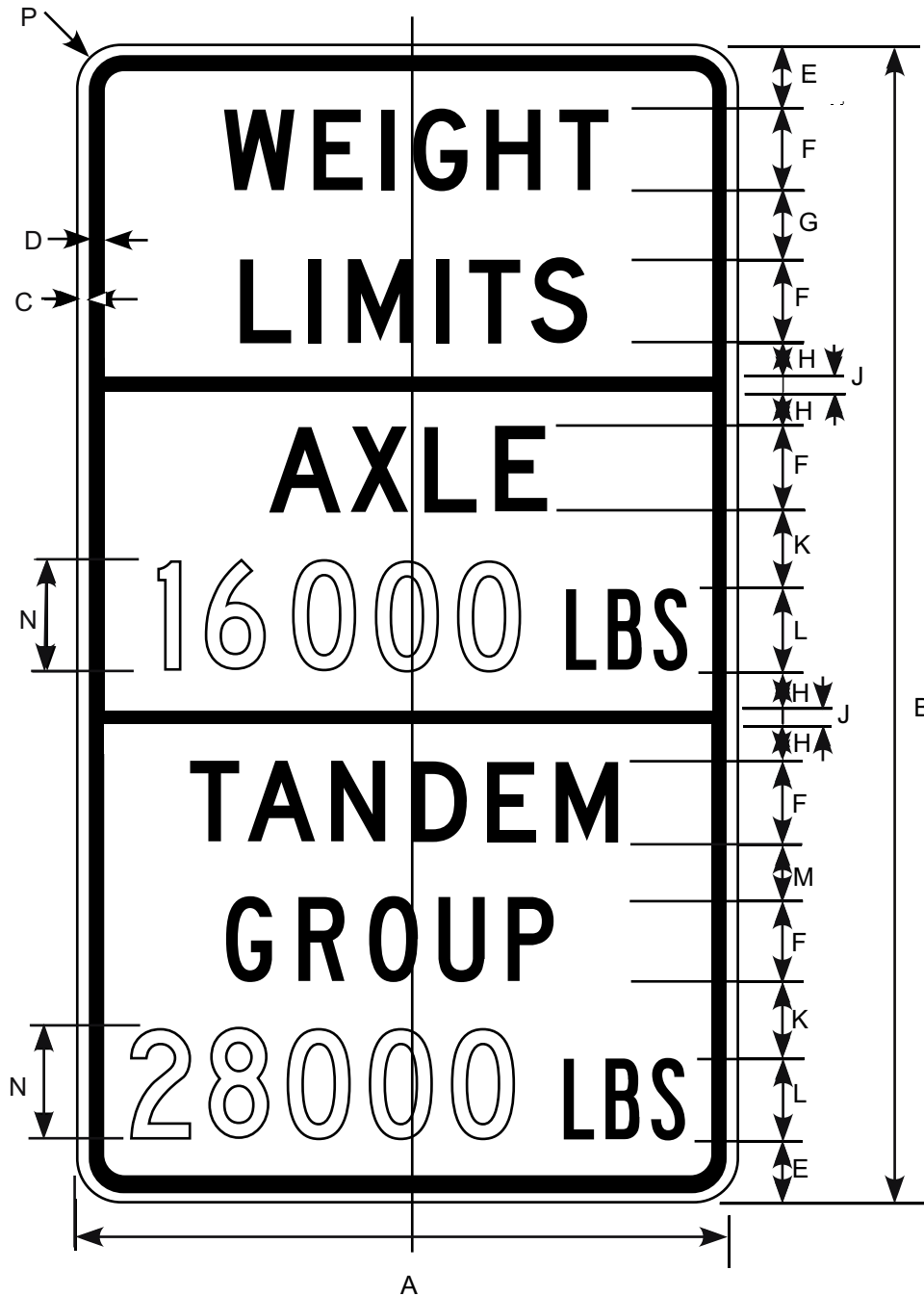

Border and Legend: Black
Background: White

Prior to the 2002 publication of this manual, this sign was numbered R12-5B.

Road Class	Dimensions (inches)													
	A	B	C	D	E	F	G	H	J	K	L	M	N	P
Conv & Min	24	42	0.38	0.63	2.25	3C	2.50	1.25	0.63	2.88	3B	2	4C	1.5

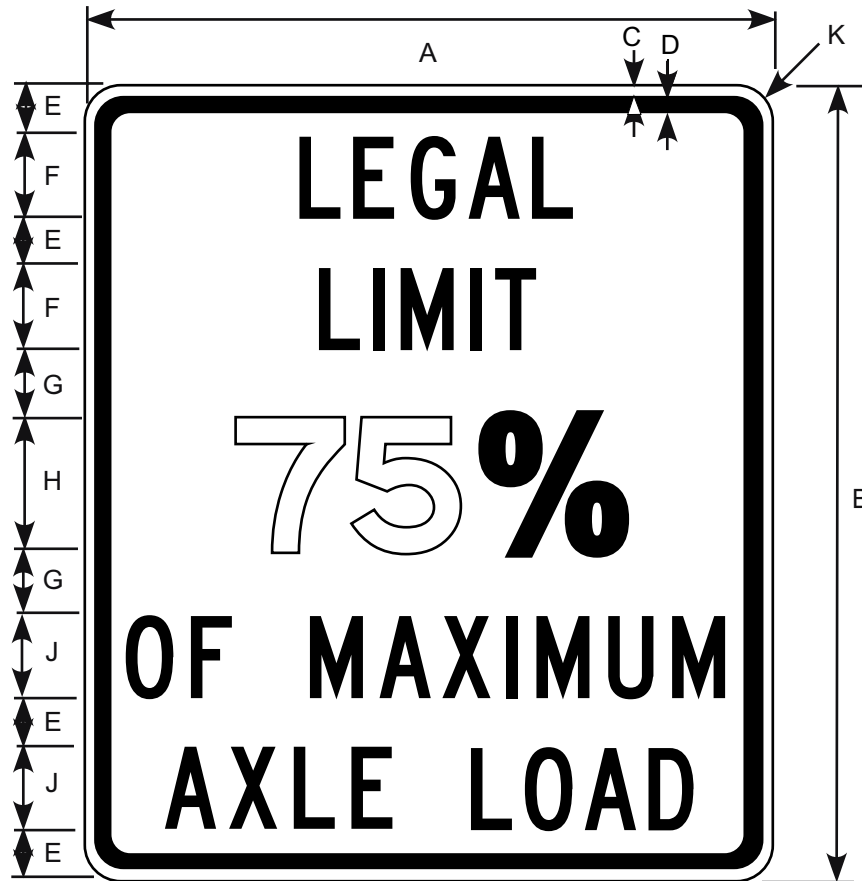

Border and Legend: Black
Background: White

Prior to the 2002 publication of this manual,
this sign was numbered R12-6.

Road Class	Dimensions (inches)									
	A	B	C	D	E	F	G	H	J	K
Conv & Min	42	48	0.63	0.88	3	5E	4	8E	5C	1.5

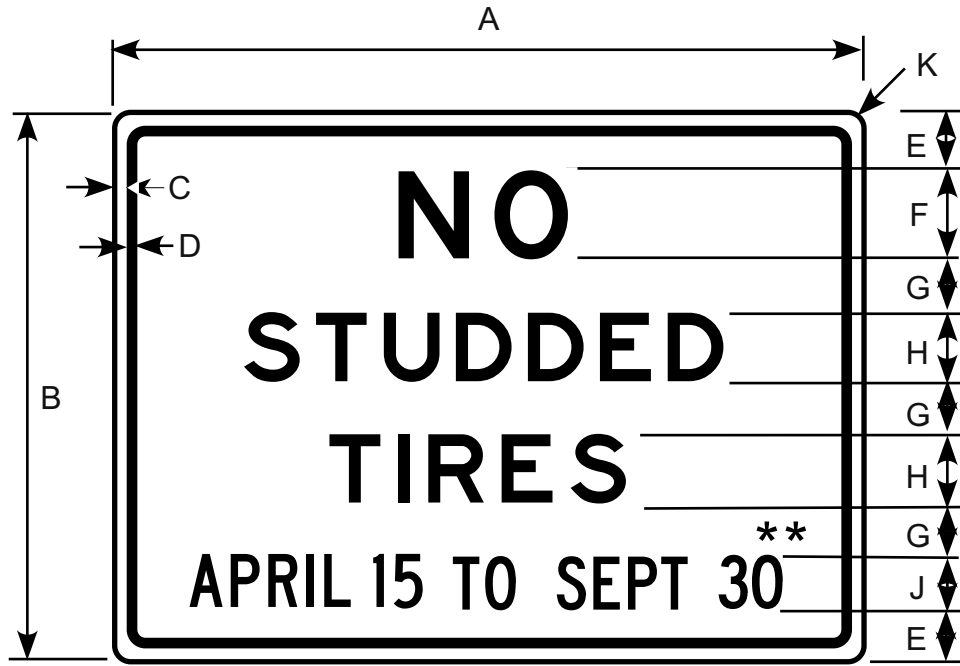

Border and Legend: Black
Background: White

- * North of 60 degrees North Latitude: May 1 to Sept. 15
- ** South of 60 degrees North Latitude: April 15 to Sept. 30

Prior to the 2002 publication of this manual,
this sign was numbered R12-7.

Road Class	Dimensions (inches)										
	A	B	C	D	E	F	G	H	J	K	
Conv & Min	84	66	1.0	1.5	8.0	10E	6.0	8E	6C	4.0	



Border and Legend: Black
Background: White

Prior to the 2002 publication of this manual,
this sign was numbered R12-8.

Road Class	Dimensions (inches)								
	A	B	C	D	E	F	G	H	J
Conv & Min	30	36	0.5	0.75	5D	4.0	5C	6.5	1.25



Border and Legend: Black
Background: White

Prior to the 2002 publication of this manual,
this sign was numbered R12-9.

Road Class	Dimensions (inches)								
	A	B	C	D	E	F	G	H	J
Conv & Min	30	36	0.5	0.75	5D	3	5C	3.5	1.25



Border and Legend: Black
Background: White

R12-10L Shown. Reverse
arrow for R12-10R.

Prior to the 2002 publication of this manual,
this sign was numbered R12-10.

*See Appendix B-1 for Standard Arrow Details.

Road Class	Dimensions (inches)									
	A	B	C	D	E	F	G	H	J	K
Conv & Min	30	36	0.50	0.75	5D	2.75	5.0	4.0	2.5	1.25

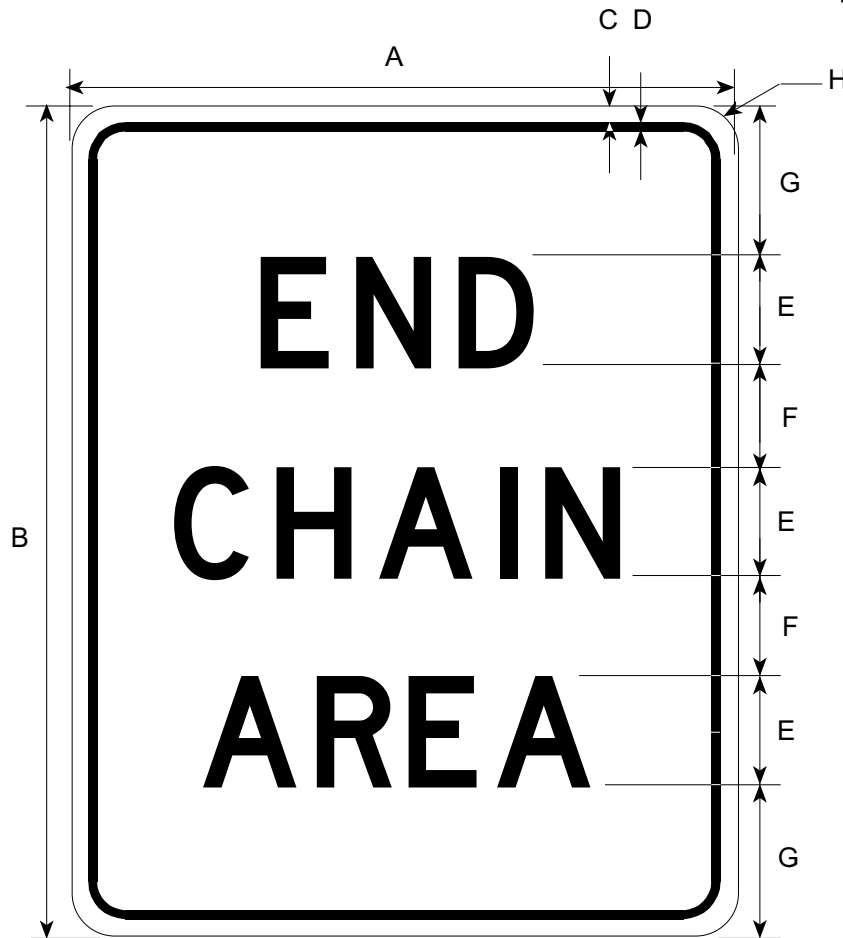

Border and Legend: Black
Background: White

Prior to the 2002 publication of this manual,
this sign was numbered R12-11.

Road Class	Dimensions (inches)							
	A	B	C	D	E	F	G	H
Conv & Min	30	36	0.5	0.75	5D	4.0	6.5	1.25

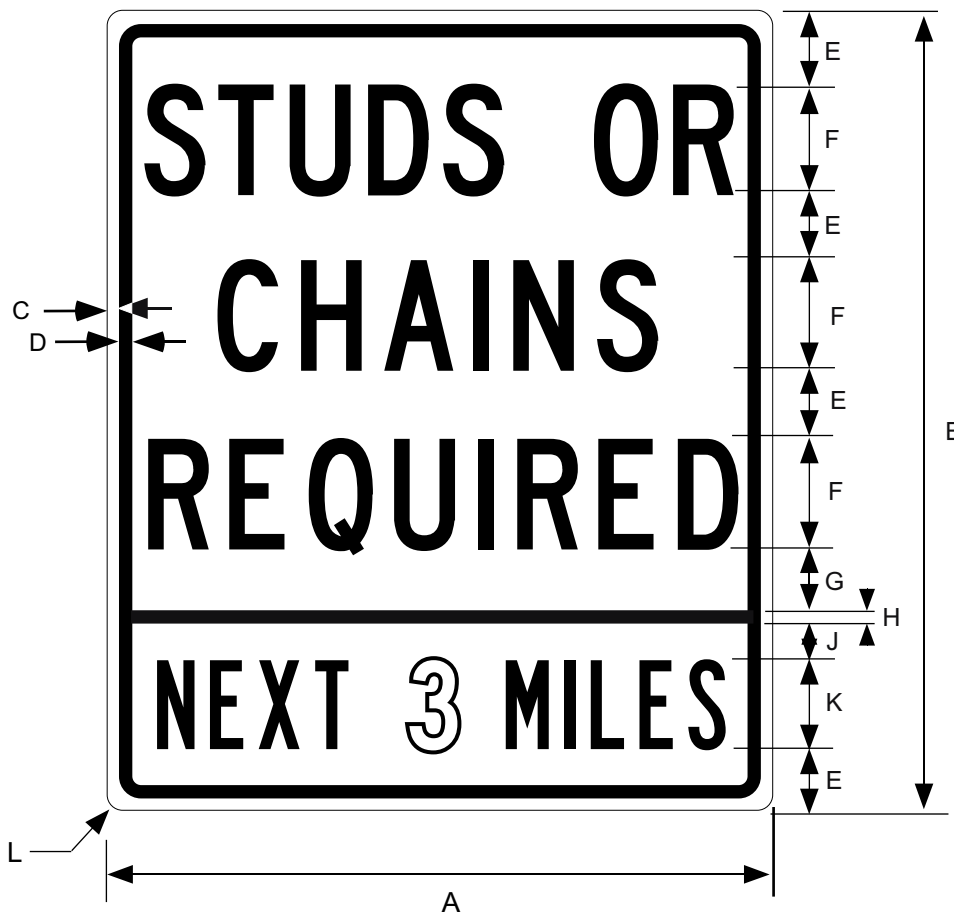

Border and Legend: Black
Background: White

Road Class	Dimensions (inches)										
	A	B	C	D	E	F	G	H	J	K	L
Min & Std	30	36	0.5	0.75	3	5C	2.63	0.75	1.63	4B	1.25

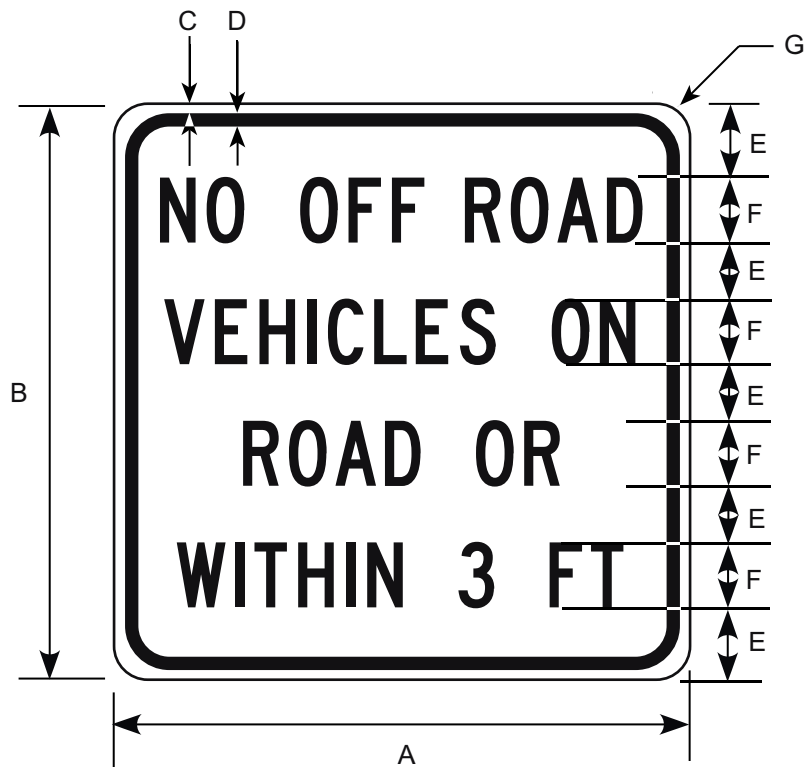

Border and Legend: Black
Background: White

Road Class	Dimensions (inches)						
	A	B	C	D	E	F	G
Conventional	36	36	0.63	0.88	4.0	4B	1.50



Border and Legend: White
Background: Black

Road Class	Dimensions (inches)						
	A	B	C	D	E	F	G
Conventional	72	48	0.75	6	6E	4	3
Expressway	96	66	0.75	8	8E	6	4
Freeway	120	84	0.75	10	10E	8	5

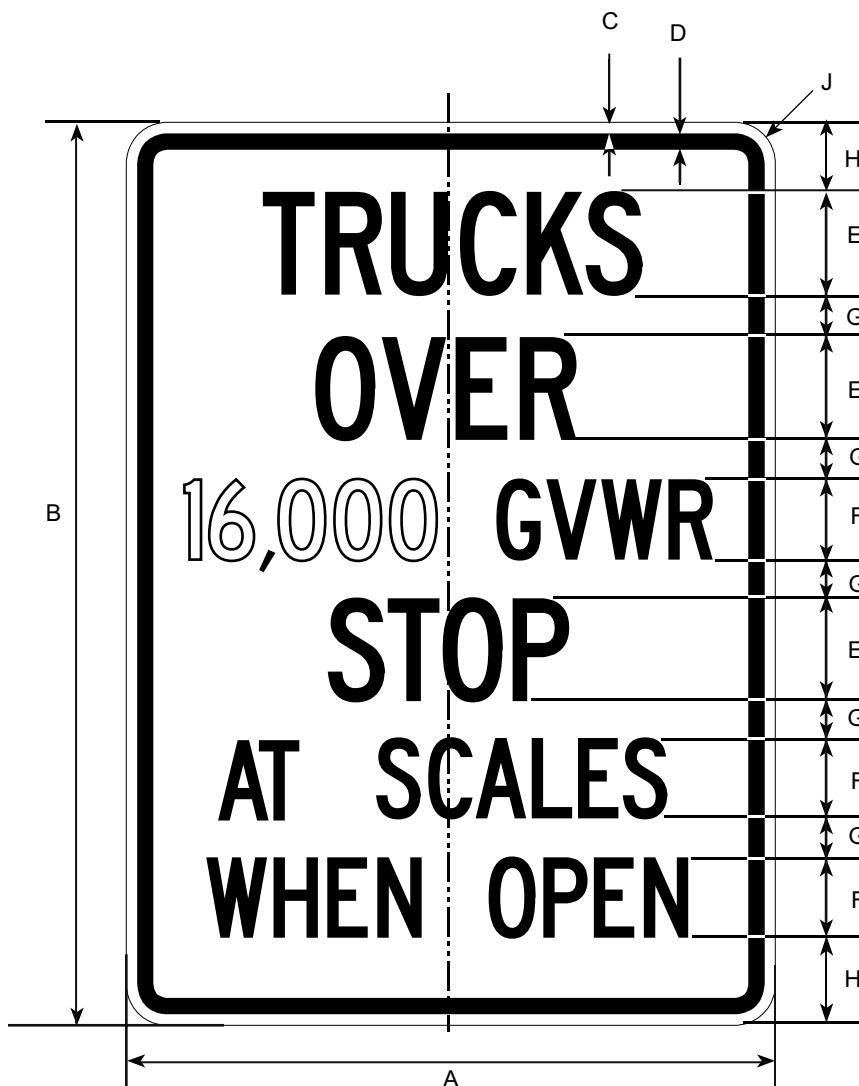

Border and Legend: Black
Background: White

Road Class	Dimensions (inches)								
	A	B	C	D	E	F	G	H	J
Conv & Min	48	72	0.8	1.25	8C	6C	4	5	3

1 1/16"x60"x0.45" SOLID BRASS PIANO HINGE COVERED TO MATCH SIGN.
STAINLESS STEEL BOLTS AND NUTS.

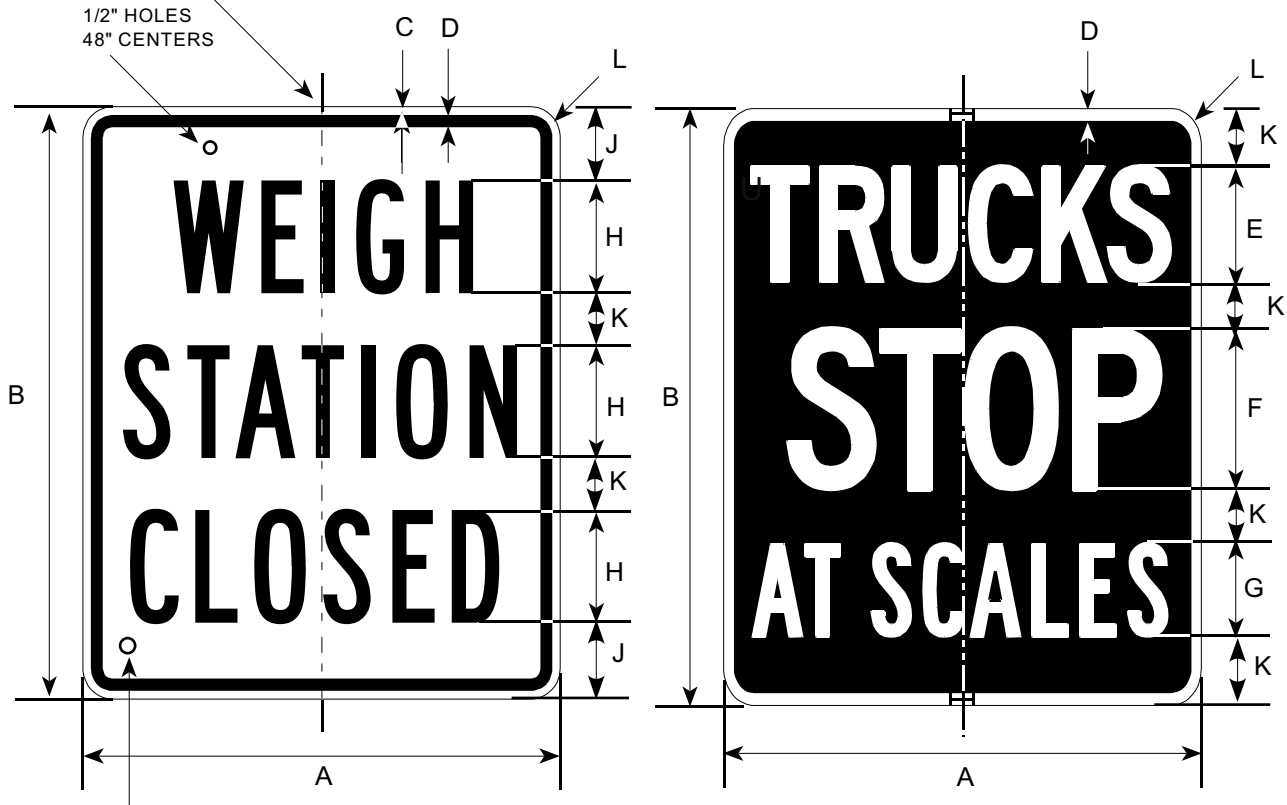

2 3/8" HOLES FOR WING-NUTS & BOLTS
1/4 " BOLT 1/2" LONG & WING NUT (STAINLESS STEEL)

REFLECTORIZED WHITE BACKGROUND WITH BLACK LETTERS AND BORDER

REFLECTORIZED LETTERS AND BORDER ON BLACK BACKGROUND

SIGN SIZE 48"x60". THIS SIGN IS COMPRISED OF ONE FULL SIZED PANEL AND ONE HALF-SIZED PANEL. HALF OF EACH MESSAGE IS ON THE FULL-SIZED PANEL. ALSO HALF OF EACH MESSAGE IS ON THE FRONT AND BACK OF THE HALF-SIZED PANEL. SIGN LOCATION IS BETWEEN THE "WEIGH STATION RIGHT LANE" AND "WEIGH STATION" GORE SIGN.

Road Class	Dimensions (inches)									
	A	B	C	D	E	F	G	H	J	K
Conv & Min	48	60	0.75	1.25	10C	14C	8B	10B	8	7

1 1/16"x72"x0.45" SOLID BRASS PIANO HINGE COVERED TO MATCH SIGN. STAINLESS STEEL BOLTS AND NUTS.

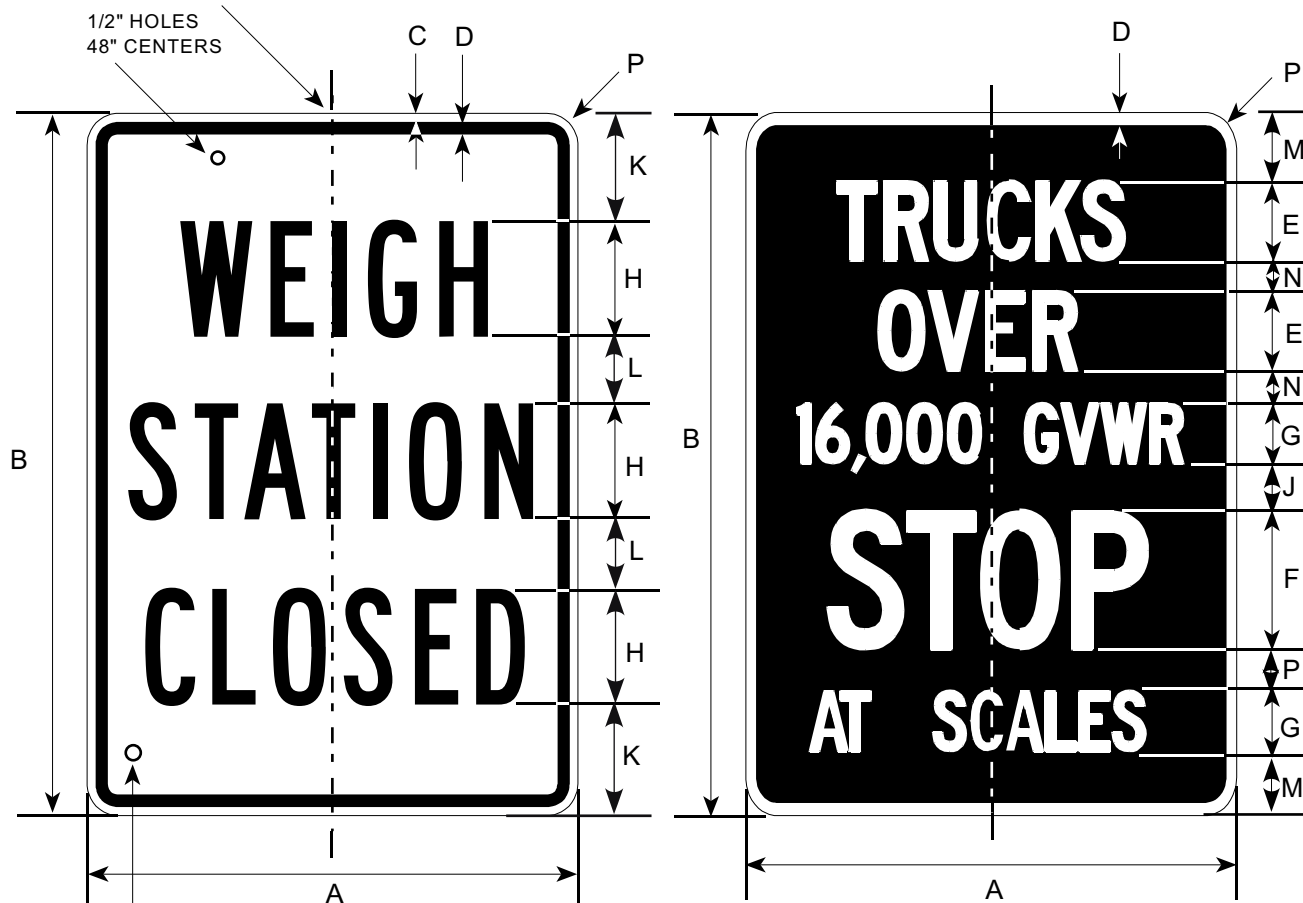

2 3/8" HOLES FOR WING-NUTS & BOLTS
1/4 " BOLT 1/2" LONG & WING NUT (STAINLESS STEEL)

REFLECTORIZED WHITE BACKGROUND WITH BLACK LETTERS AND BORDER

REFLECTORIZED LETTERS AND BORDER ON BLACK BACKGROUND

SIGN SIZE 48"x72". THIS SIGN IS COMPRISED OF ONE FULL SIZED PANEL AND ONE HALF-SIZED PANEL. HALF OF EACH MESSAGE IS ON THE FULL-SIZED PANEL. ALSO HALF OF EACH MESSAGE IS ON THE FRONT AND BACK OF THE HALF-SIZED PANEL. SIGN LOCATION IS BETWEEN THE "WEIGH STATION RIGHT LANE" AND "WEIGH STATION" GORE SIGN.

Road Class	Dimensions (inches)													
	A	B	C	D	E	F	G	H	J	K	L	M	N	P
Conv & Min	48	72	0.8	1.25	8C	14C	6C	10B	6	11	10	5	4	3

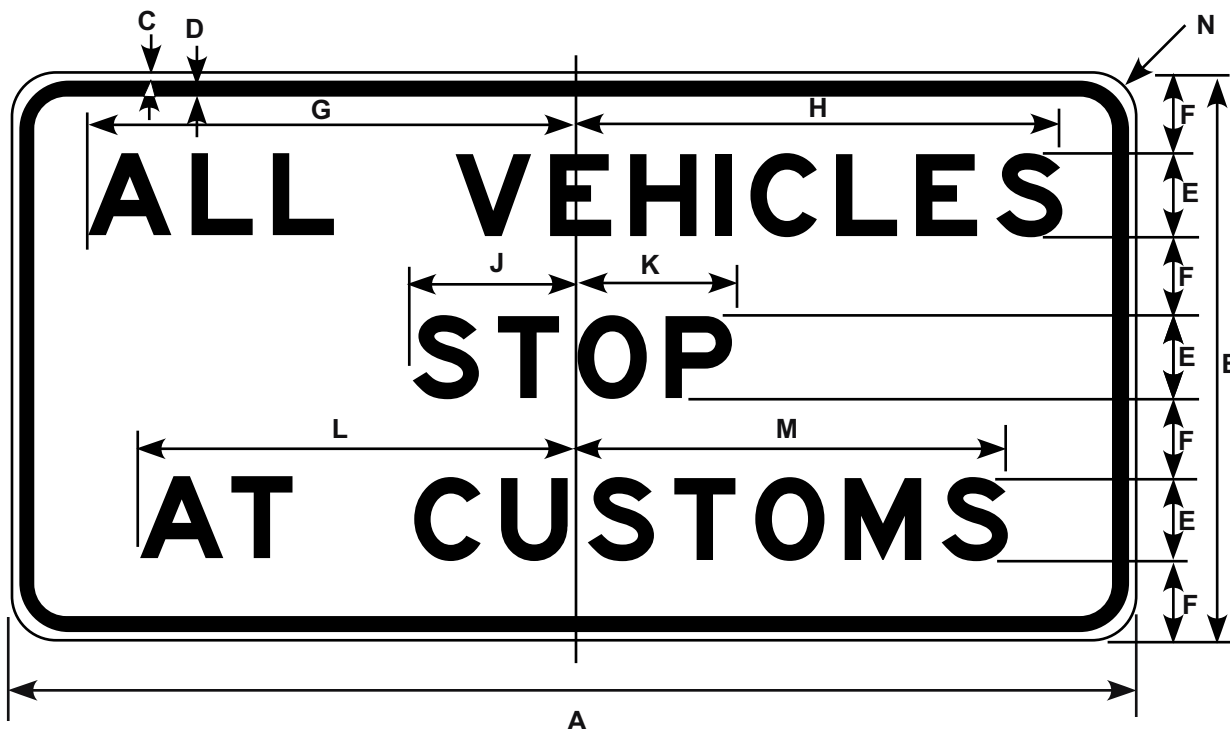

Border and Legend: Black
Background: White

Prior to the 2002 publication of this manual,
this sign was numbered R13-2.

Road Class	Dimensions (inches)													
	A	B	C	D	E	F	G	H	J	K	L	M	N	
Conv & Min	84	42	1.25	0.75	6E	6.0	35	34.75	11.5	11.5	31.13	31.13	6.0	
Expressway	108	54	1.25	0.75	8E	7.5	46.38	46.38	15.63	15.0	41.5	41	7.0	
Freeway	132	66	1.5	0.88	10E	9.0	58	58	19.25	19.0	52	51.63	8.0	

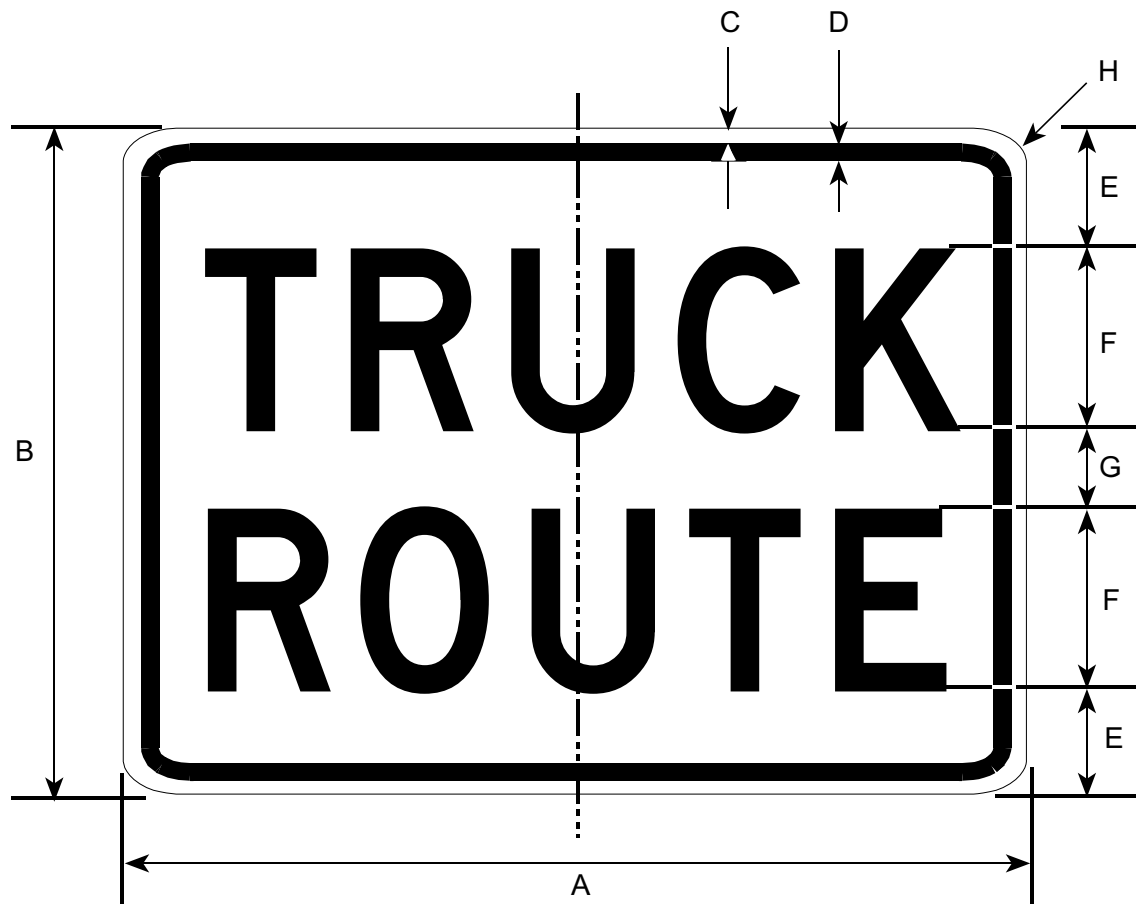

Border and Legend: Black
Background: White

Road Class	Dimensions (inches)							
	A	B	C	D	E	F	G	H
Conv & Min	24	18	0.38	0.63	3	5D	2	1.5

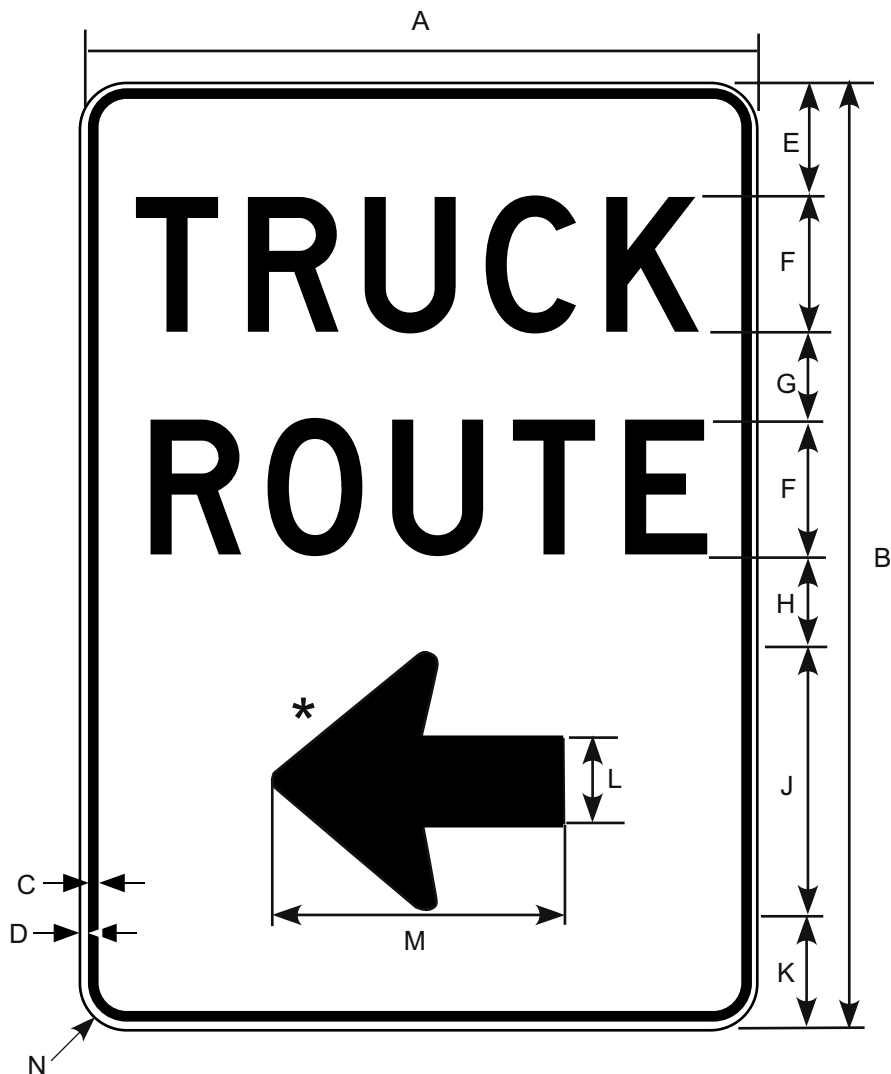

Border and Legend: Black
Background: White

*See Appendix B-1 for Standard Arrow Details.

Road Class	Dimensions (inches)												
	A	B	C	D	E	F	G	H	J	K	L	M	N
Conventional	30	42	0.75	0.50	5.0	6D	4.0	3.0	14.25	3.75	3.88	12.75	1.88

R14-2

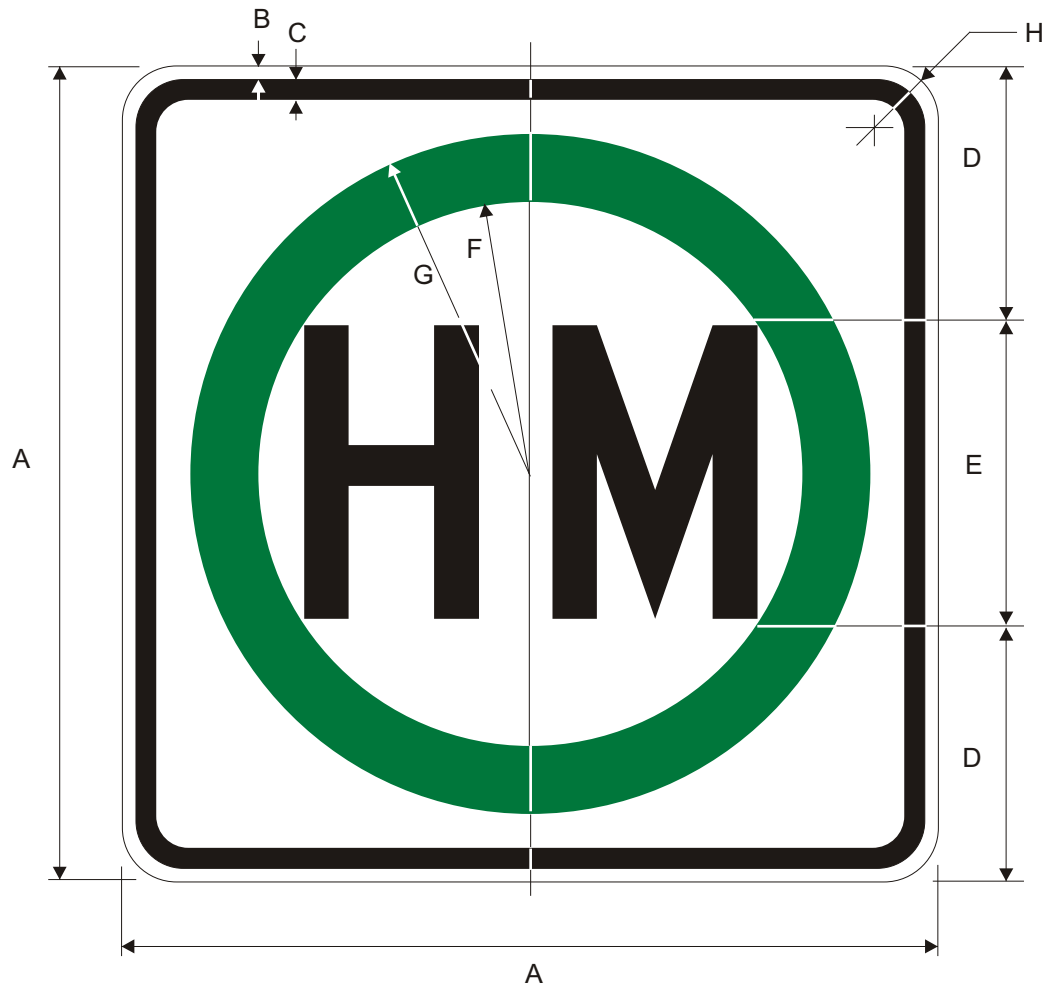

Circle: Green
 Border and Letter: Black
 Background: White

Road Class	Dimensions (inches)							
	A	B	C	D	E	F	G	H
Conv.	24	0.38	0.63	7.5	9C	8.0	10	1.5
Expy.	30	0.50	0.75	10	10C	10	12.5	1.88
Fwy.	36	0.63	0.88	12	12C	12	15	2.25
Oversized	42	0.63	0.88	14	14C	14	17.5	2.25



Circle and Diagonal: Red
 Border and Letter: Black
 Background: White

Road Class	Dimensions (inches)								
	A	B	C	D	E	F	G	H	J
Conv.	24	0.38	0.63	7.5	9C	8.0	10	2.0	1.5
Expy.	30	0.5	0.75	10	10C	10	12.5	2.5	1.88
Fwy.	36	0.63	0.88	12	12C	12	15	3.0	2.25
Oversized	42	0.63	0.88	14	14C	14	17.5	3.5	2.25

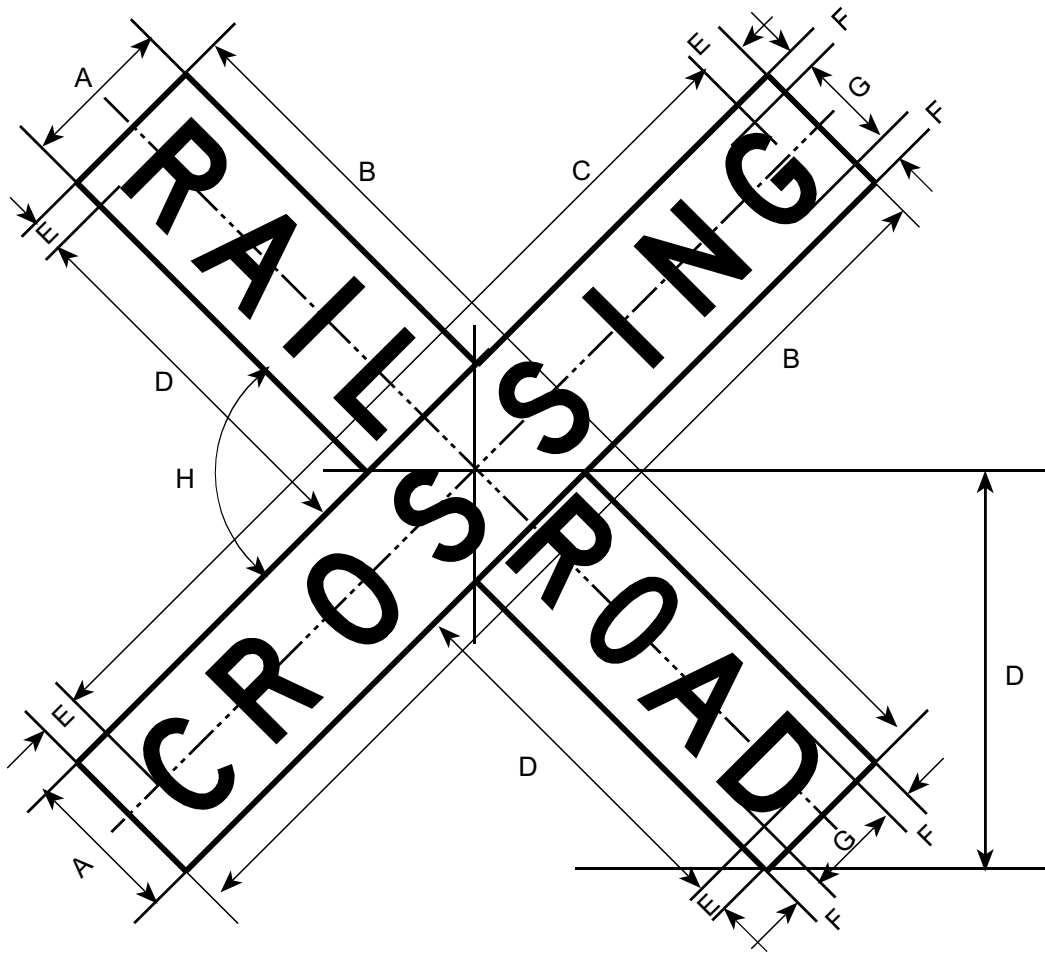

Border and Legend: Black
Background: White

NOTE: A strip of high intensity or brighter retroreflective white material not less than six inches in width shall be installed on the back of each blade of each crossbuck sign for the length of each blade. Also, a two inch strip of the same material shall be installed for the full length of the front and back of each support from the crossbuck sign or Number of Tracks (R15-2) sign to near ground level.

Road Class	Dimensions (inches)							
	A	B	C	D	E	F	G	H
Conv & Mi	9	48	45	18	1.5	1.75	5.5D	90°

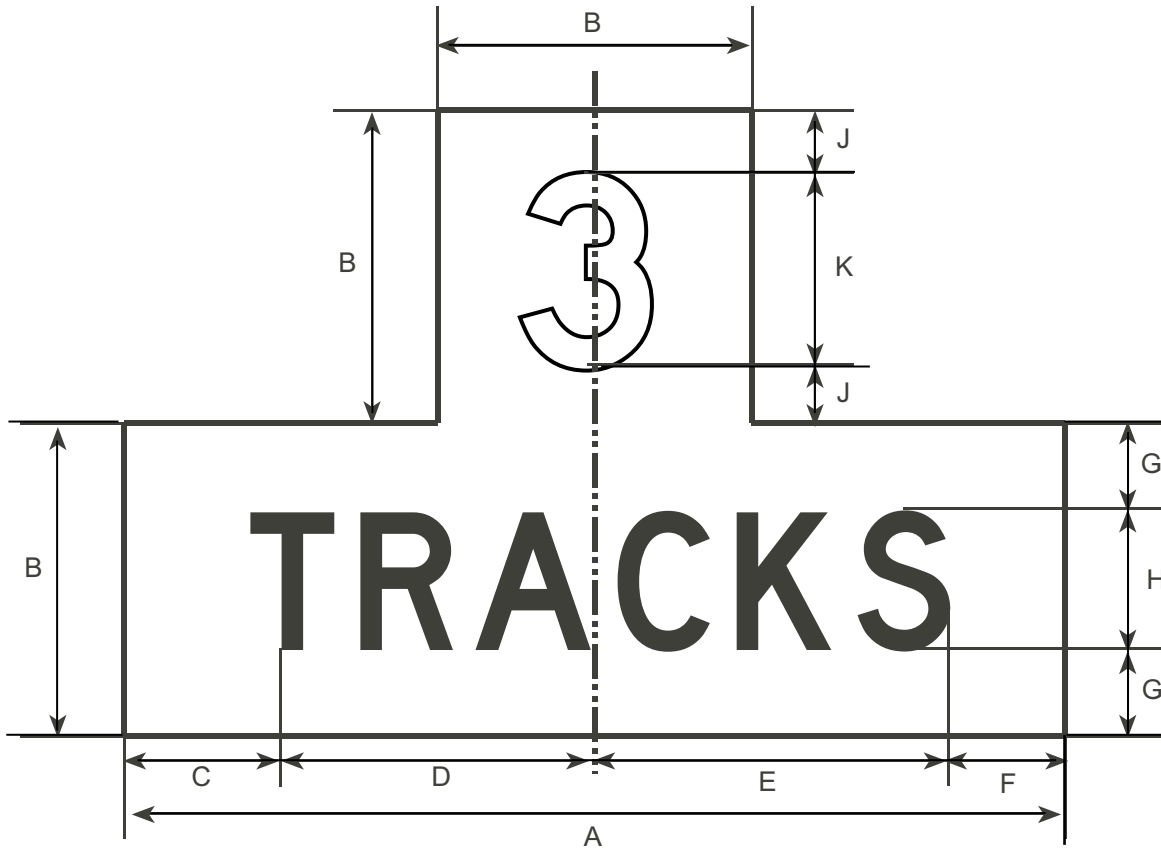

Border and Legend: Black
Background: White

NOTE: A strip of high intensity or brighter retroreflective white material not less than 2 inches in width shall be installed for the full length of the front and back of each support from the crossbuck sign or Number of Tracks (R15-2) to near ground level.

Road Class	Dimensions (inches)									
	A	B	C	D	E	F	G	H	J	K
Conv & Min	27	9	3.5	10	9.88	3.62	2.5	4D	1.75	5.5D

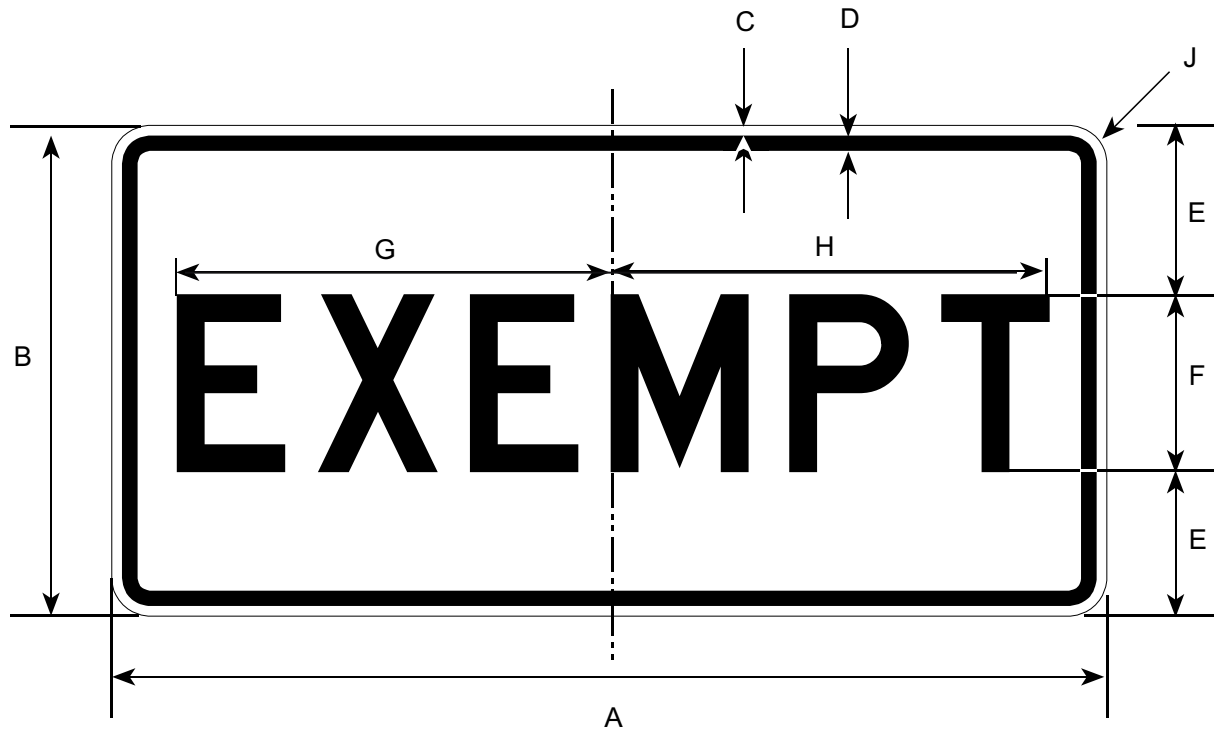

Border and Legend: Black
 Background: White

Road Class	Dimensions (inches)								
	A	B	C	D	E	F	G	H	J
Conv & Min	24	12	0.38	0.63	4	4D	9.75	10	1.5

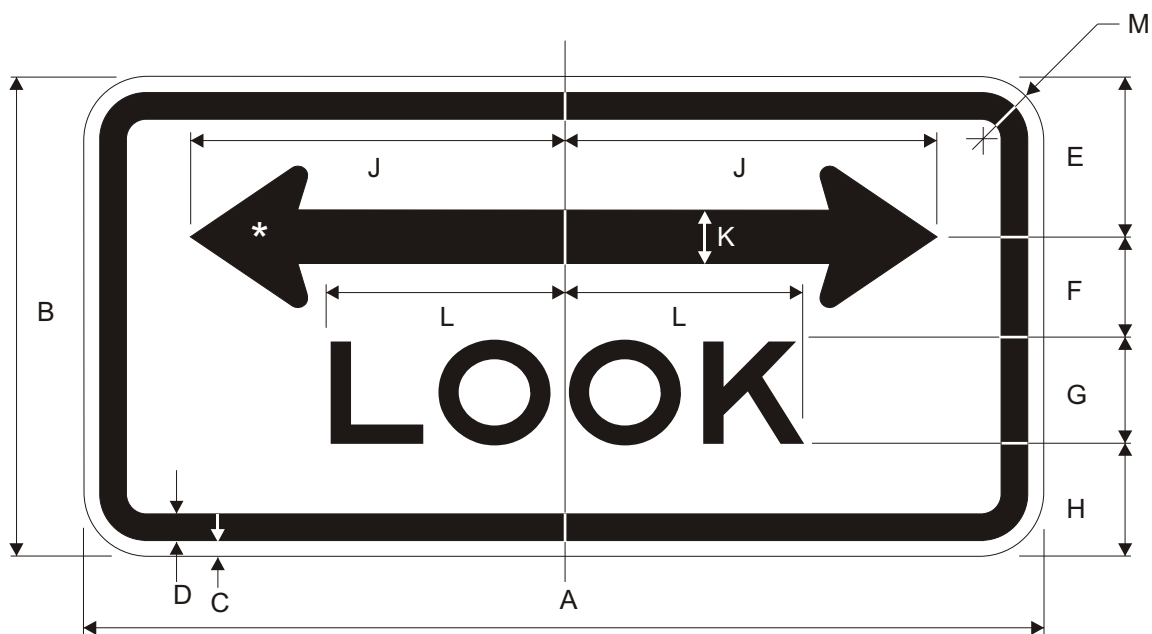

Border and Legend: Black
Background: White

*See Appendix B-1 for Standard Arrow Details.

Road Class	Dimensions (inches)											
	A	B	C	D	E	F	G	H	J	K	L	M
Conventional	36	18	0.63	0.88	6.0	4.0	4F	4.3	14	2.0	8.91	2.25
Expy/Frwy	48	24	0.8	1.25	8.0	5.0	5F	5.8	18	2.5	11.13	3.0

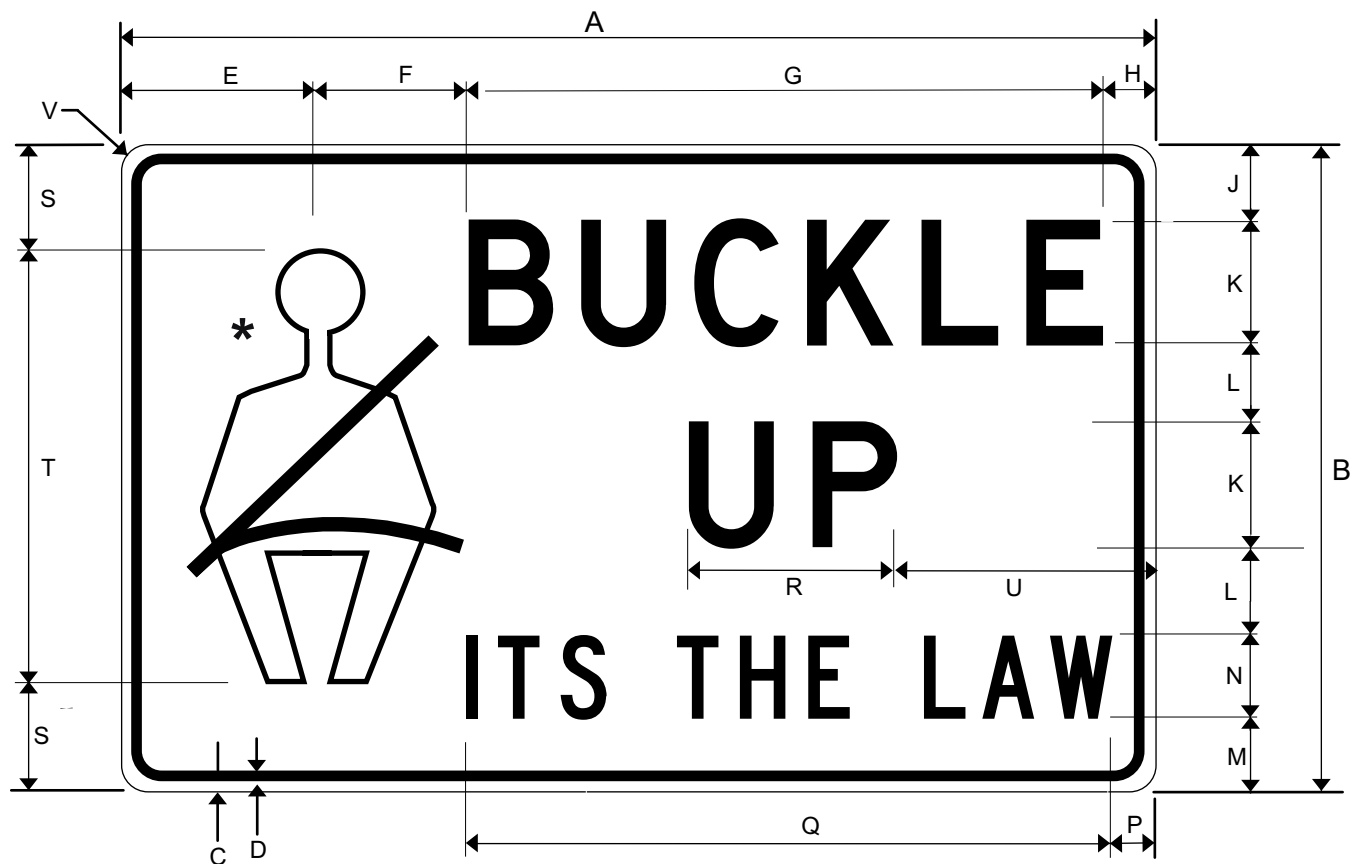

* Make seat belt symbol proportional to the graphic shown.

Border and Legend: Black
Background: White

Road Class	Dimensions (inches)																			
	A	B	C	D	E	F	G	H	J	K	L	M	N	P	Q	R	S	T	U	V
Conv & Mn	48	30	0.38	0.63	9.0	6.75	29.75	2.5	4.5	6D	3.5	2.5	4C	2.5	30.5	9.5	5.38	19.25	12.5	1.5



Border and Legend: Black
 Upper Background: Orange
 Lower Background: White

Prior to the 2002 publication of this manual,
 this sign was numbered AK-CR16-100.

Road Class	Dimensions (inches)											
	A	B	C	D	E	F	G	H	I	J	K	L
Conv & Min	36	48	0.88	0.63	3	4C	1.37	3.25	6E	5D	4.75	2.25



Border and Legend: Black
 Background: White

Prior to the 2002 publication of this manual,
 this sign was numbered AK-CR16-101.

Road Class	Dimensions (inches)								
	A	B	C	D	E	F	G	H	J
Conv & Min	36	42	0.88	0.63	5.25	5D	3.5	6E	2.25

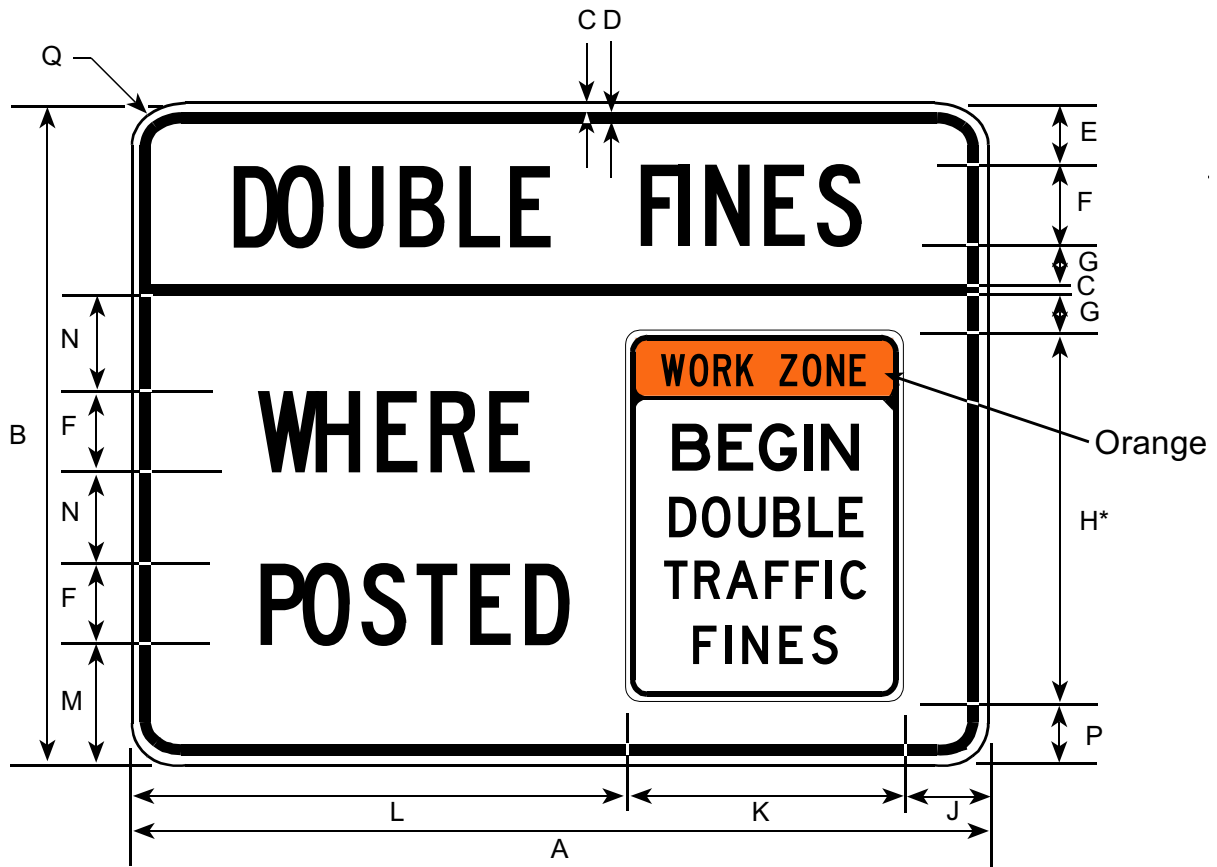

Border and Legend: Black
 Background: White
 "Work Zone" Background: Orange

* "WORK ZONE BEGIN DOUBLE TRAFFIC FINES" insert is 75% of R16-100 dimensions.

Prior to the 2002 publication of this manual, this sign was numbered AK-CR16-102.

Road Class	Dimensions (inches)														
	A	B	C	D	E	F	G	H	J	K	L	M	N	P	Q
Conv & Min	84	66	0.75	1.38	6.25	8C	4.0	36*	8.25	27	48.75	12.24	9.38	7.0	3.0

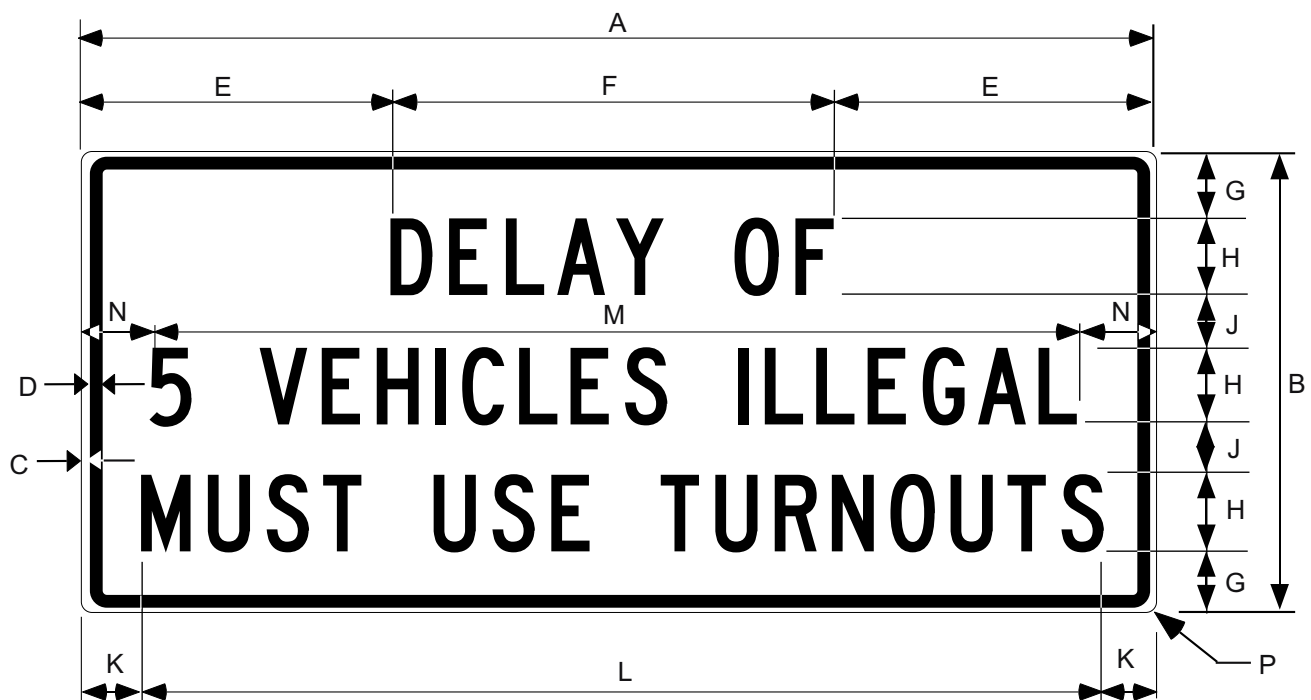

Border and Legend: Black
Background: White

Road Class	Dimensions (inches)													
	A	B	C	D	E	F	G	H	J	K	L	M	N	P
Conventional	84	36	0.75	1.25	24.7	34.6	5.0	6C	4.0	4.50	75	72.4	5.8	4.0

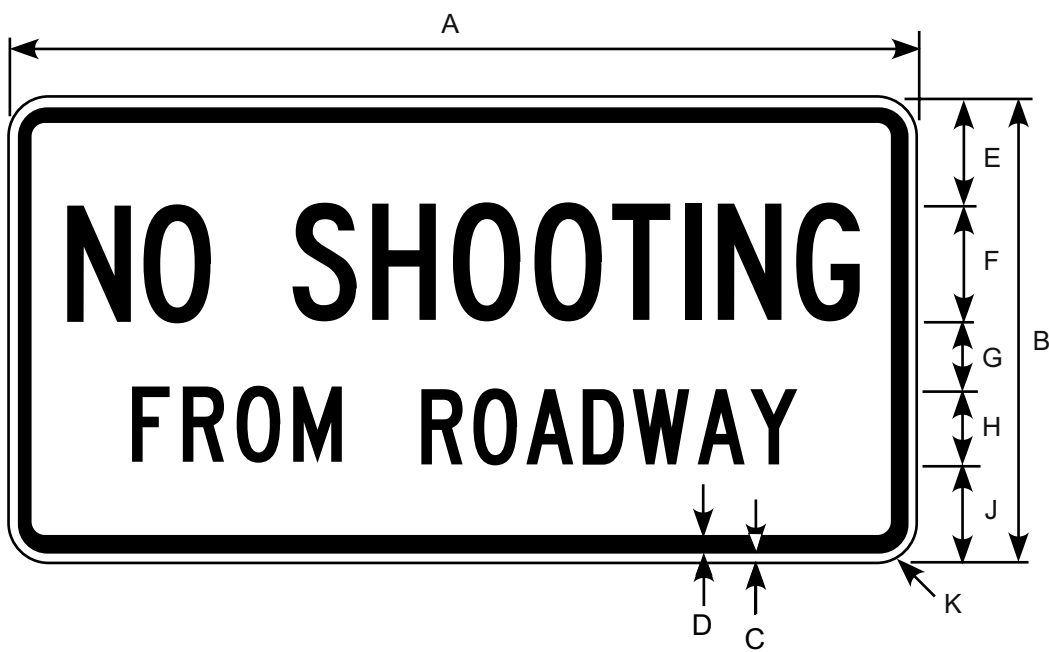

Border and Legend: Black
Background: White

Prior to the 2002 publication of this manual,
this sign was numbered R16-2.

Road Class	Dimensions (inches)									
	A	B	C	D	E	F	G	H	J	K
Conv & Min	48	24	0.63	0.88	5.5	6C	3.5	4C	5	2.25

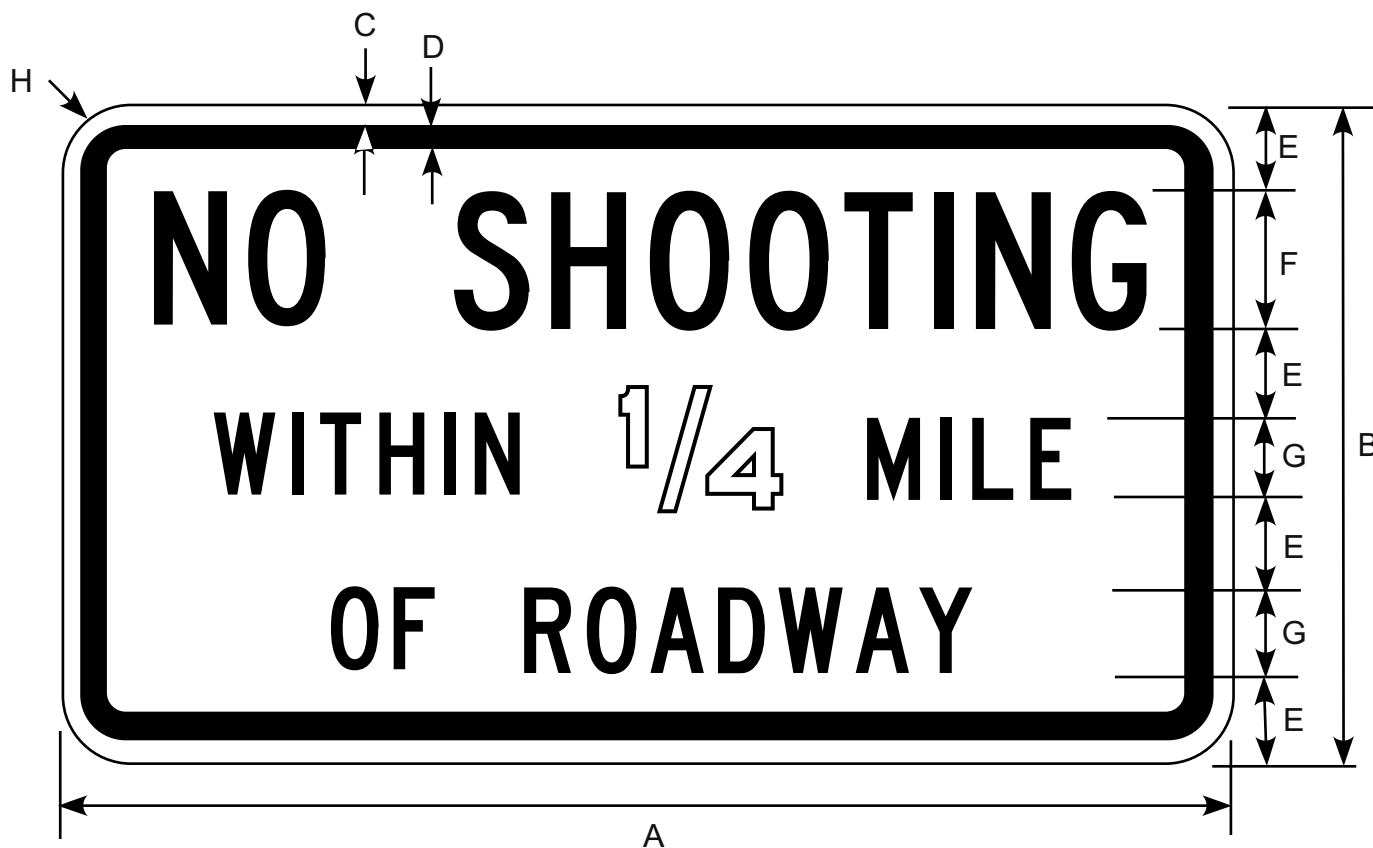

Border and Legend: Black
Background: White

Prior to the 2002 publication of this manual,
this sign was numbered R16-3.

Road Class	Dimensions (inches)							
	A	B	C	D	E	F	G	H
Conv & Min	54	30	0.75	1.25	4	6C	4C	3

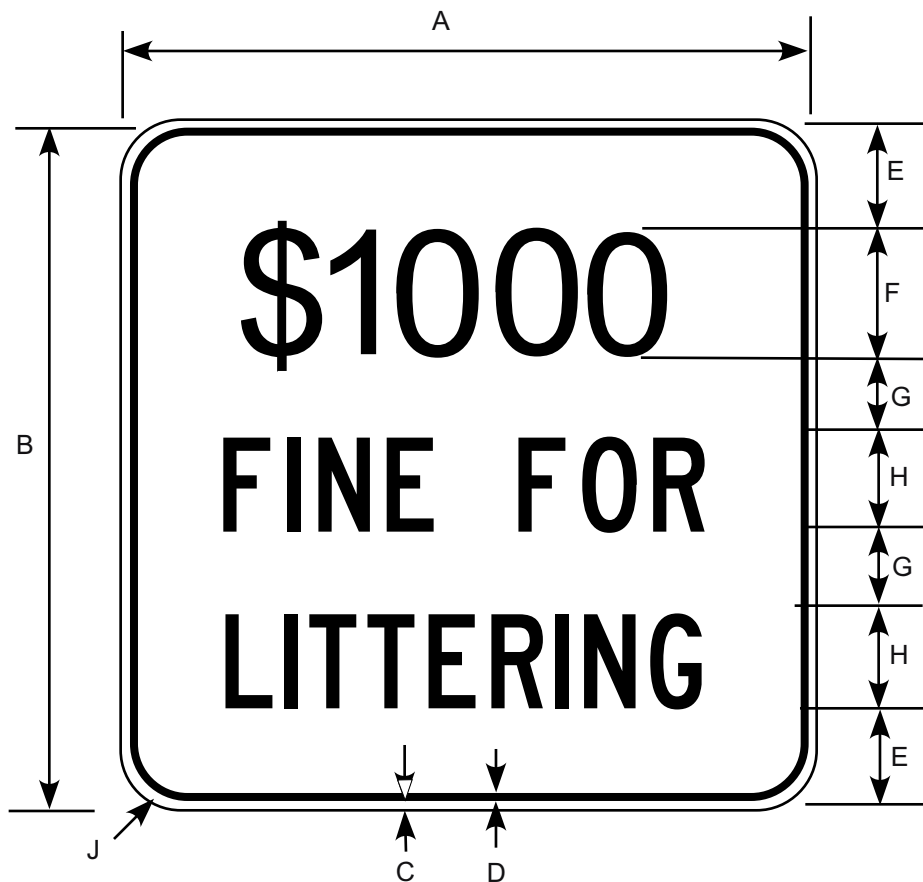

Border and Legend: Black
Background: White

Prior to the 2002 publication of this manual,
this sign was numbered R16-1.

Road Class	Dimensions (inches)								
	A	B	C	D	E	F	G	H	J
Conv & Min	42	42	0.75	1.25	6	8C	5	6C	2.25



Border and Legend: Black
Background: White

Road Class	Dimensions (inches)								
	A	B	C	D	E	F	G	H	J
Conv & Min	24	30	0.38	0.63	5D	4D	2	3	1.5

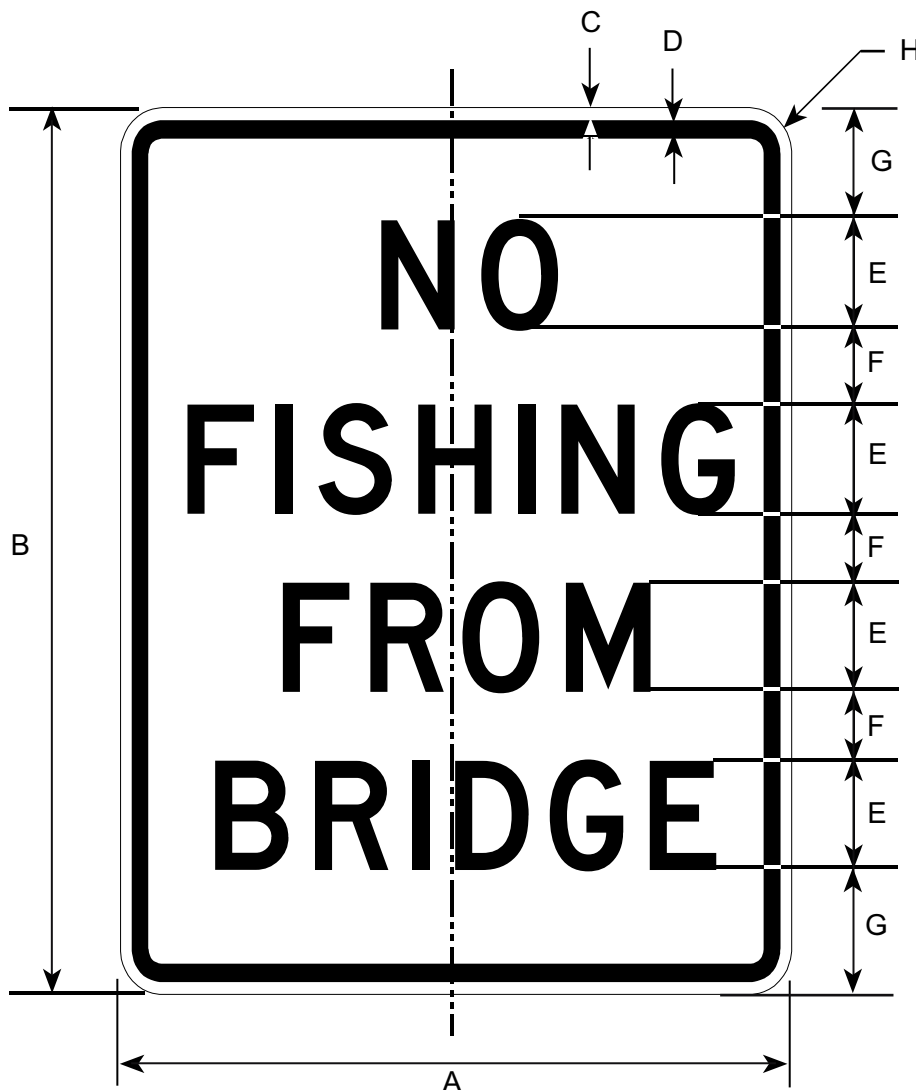

Border and Legend: Black
Background: White

Road Class	Dimensions (inches)							
	A	B	C	D	E	F	G	H
Conv & Min	18	24	0.38	0.63	3D	2	3	1.5

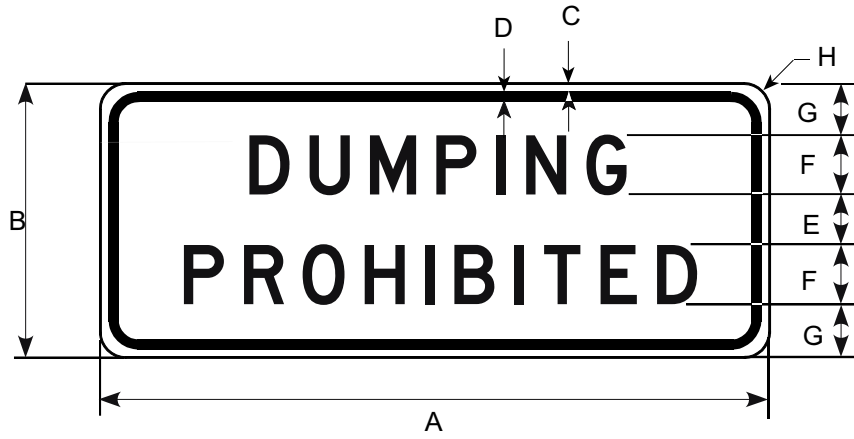

Border and Legend: Black
 Background: White

Road Class	Dimensions (inches)							
	A	B	C	D	E	F	G	H
Conv & Min	30	14	0.38	0.5	3	3D	2.5	1.5

R16-110

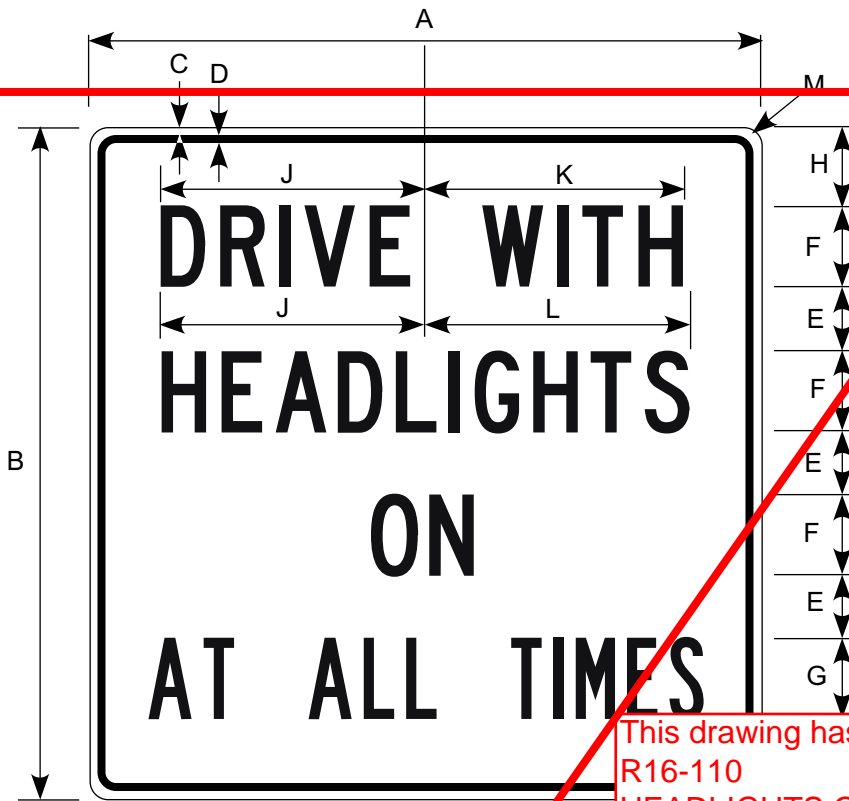

This drawing has been replaced with:
R16-110
HEADLIGHTS ON AT ALL TIMES
 (04/12/10).

Click on the drawing number in the upper right corner to go to the Interim Addenda web page.

Border and Legend: Black
 Background: White

Road Class	Dimensions (inches)											
	A	B	C	D	E	F	G	H	J	K	L	M
Conventional	42	42	0.63	0.88	4	5C	5B	5	16.50	16.25	16.63	2.25

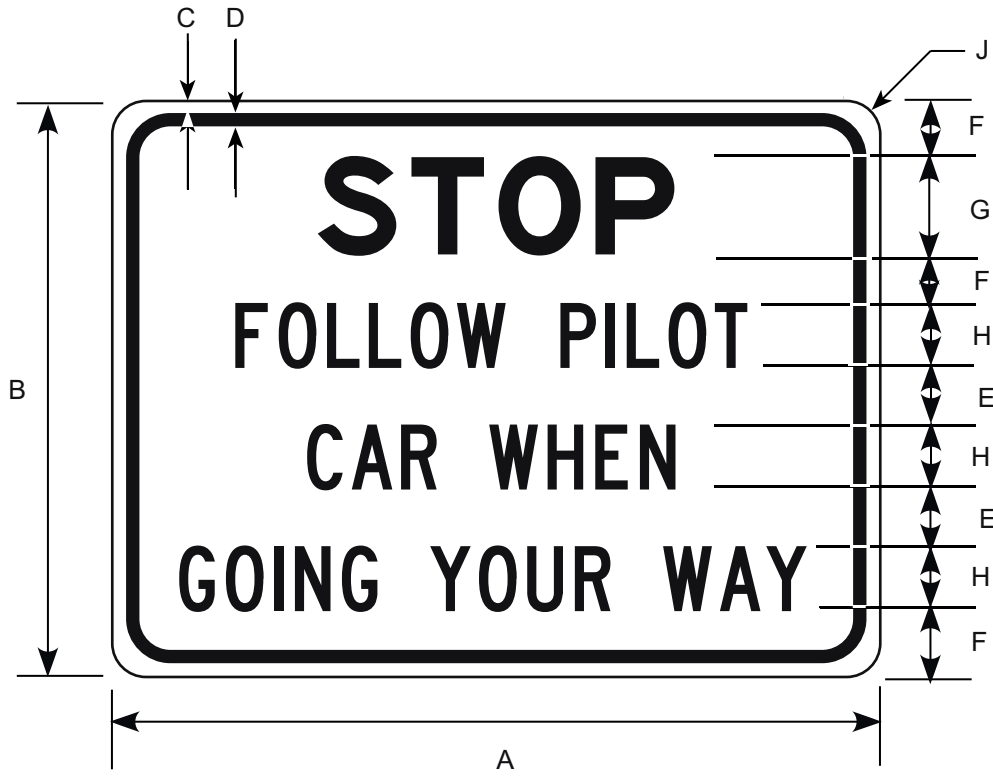

Border and Legend: Black
Background: White

Road Class	Dimensions (inches)								
	A	B	C	D	E	F	G	H	J
All	48	36	0.63	0.88	3	4	6E	4C	2.25



Border and Legend: Black
 Background: White / Fluorescent Yellow-Green

Road Class	Dimensions (inches)										
	A	B	C	D	E	F	G	H	J	K	L
Conventional	84	66	0.75	1.25	7.0	8D	6	8	8E	33	3



Border and Legend: Black
 Upper Background: Fluorescent Yellow-Green
 Lower Background: White

Road Class	Dimensions (inches)											
	A	B	C	D	E	F	G	H	J	K	L	M
Conv & Min	36	48	0.88	0.63	3	4C	1.38	3.25	5D	4.75	6E	2.25

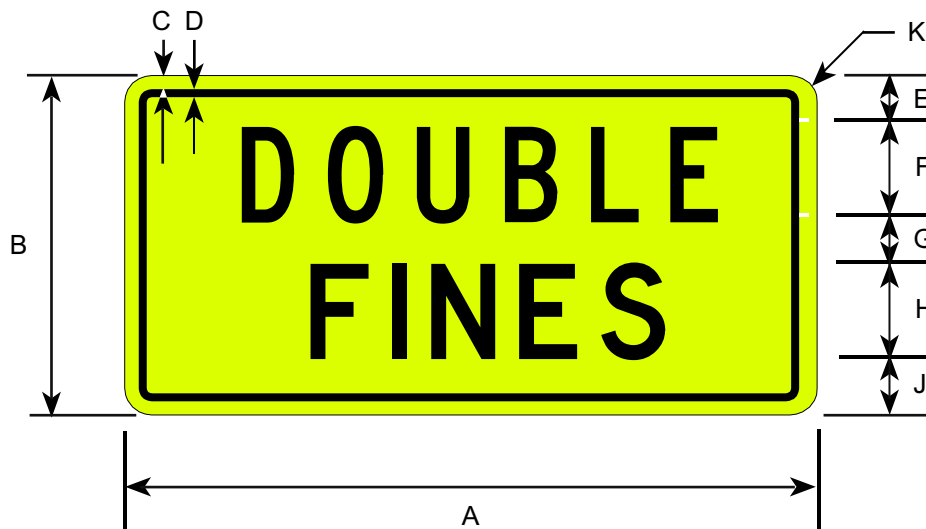

Border and Legend: Black
 Background: Fluorescent Yellow-Green

Road Class	Dimensions (inches)									
	A	B	C	D	E	F	G	H	J	K
Conventional	30	18	0.50	0.75	2.5	5C	2.5	5D	3	1.88



Border and Legend: Black
 Background: White

Road Class	Dimensions (inches)							
	A	B	C	D	E	F	G	H
Conv & Min	72	36	0.75	1.25	6C	5	4	2

SCHOOL SIGNS

S1-1 to S6-1

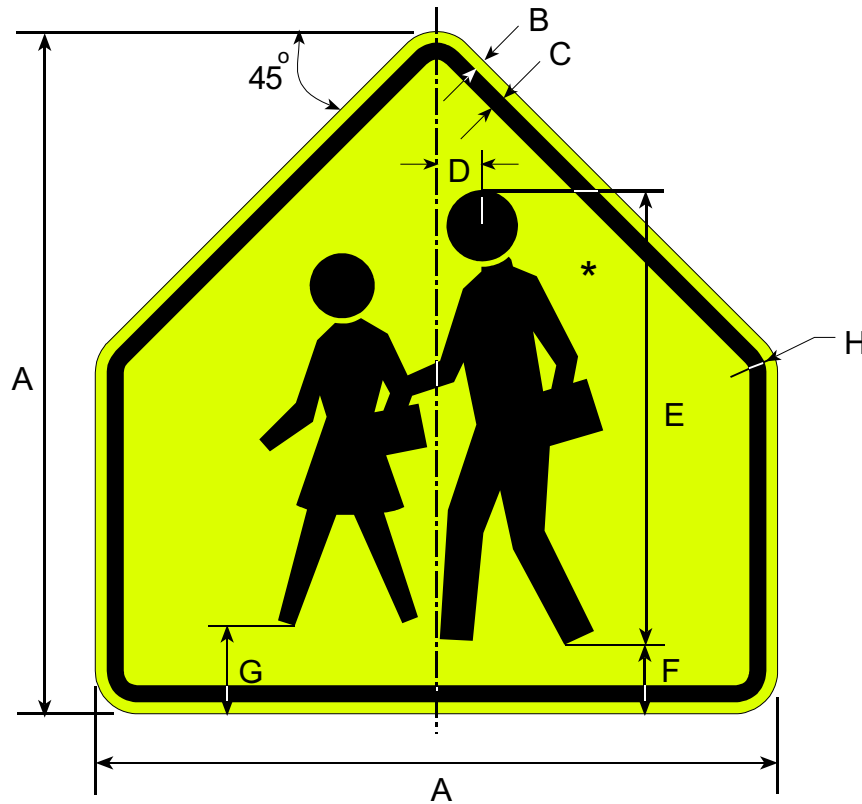

Border and Legend: Black
 Background: Fluorescent Yellow-Green

* Make symbol proportional to the one shown.

S1-1s used in advance of a crossing shall be supplemented with W16-9P "AHEAD" or W16-2, "XXX FEET" plates.

S1-1s used at a crossing shall be supplemented with a W16-7P diagonal down-arrow plate.

When a plate is used with S1-1, it shall be the same color as the S1-1.

Road Class	Dimensions (inches)							
	A	B	C	D	E	F	G	H
Minimum	30	0.50	0.75	2.00	20	3.0	3.75	1.88
Conventional	36	0.63	0.88	2.50	24	3.5	4.50	2.25
Expwy/Oversized	48	0.75	1.25	3.25	32	5.0	6.00	3.00

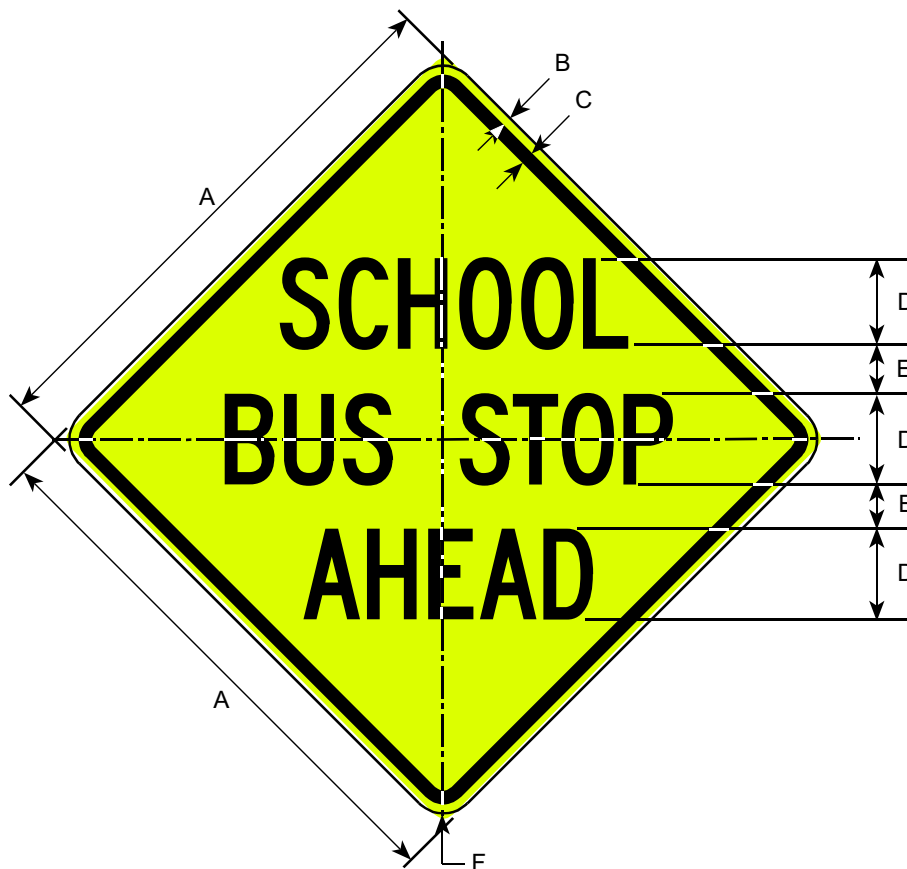

Border and Legend: Black
 Background: Fluorescent Yellow-Green

Road Class	Dimensions (inches)					
	A	B	C	D	E	F
Minimum	30	0.50	0.75	5C	2	1.88
Conventional	36	0.63	0.88	6C	3	2.25
Expw/Oversized	48	0.75	1.25	8C	5	3.00



Border and Legend: Black
Background: White

Time is variable.

Road Class	Dimensions (inches)							
	A	B	C	D	E	F	G	H
Minimum	30	12	0.38	0.63	2.00	3D	2.0	1.50
Conventional	36	18	0.63	0.88	3.25	5D	1.5	2.25
Epxwy/Oversized	48	24	0.75	1.25	4.75	6D	2.5	3.00

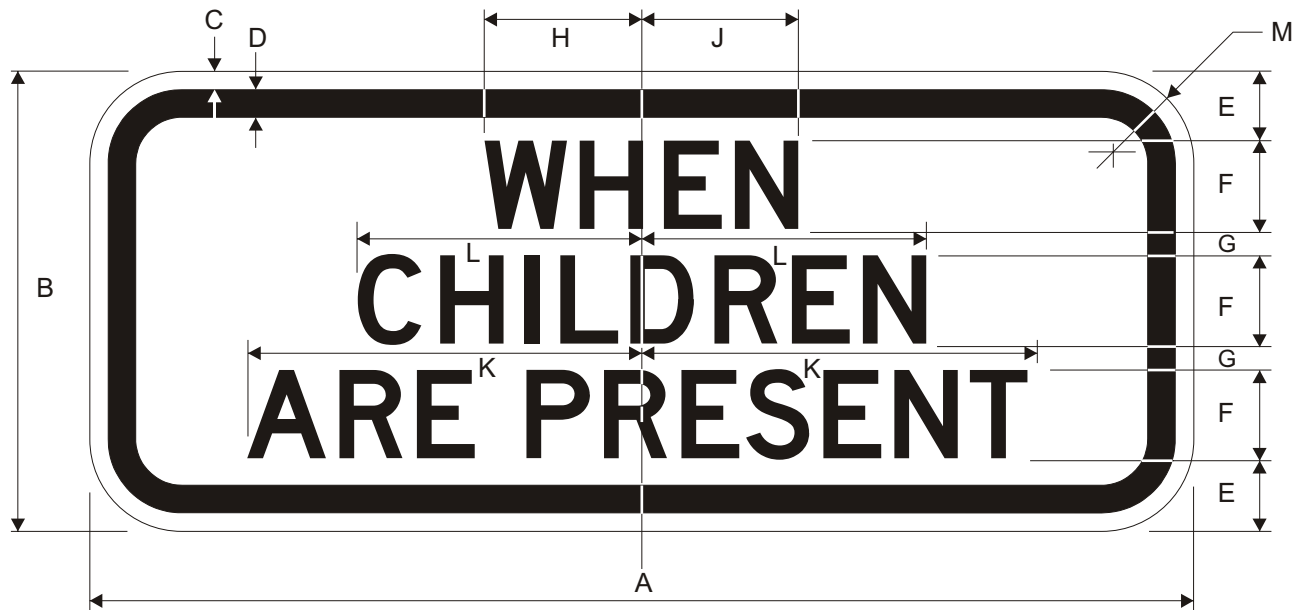

Border and Legend: Black
Background: White

Road Class	Dimensions (inches)											
	A	B	C	D	E	F	G	H	J	K	L	M
Min.	24	10	0.38	0.63	1.5	2D	0.50	3.5	3.31	9.31	6.25	1.5
Conv.	36	18	0.63	0.88	3.0	3D	1.5	5.19	5.13	14	9.38	2.25
Oversized	42	24	0.75	1.25	4.0	4D	2.0	7.0	6.63	18.63	12.5	3.0

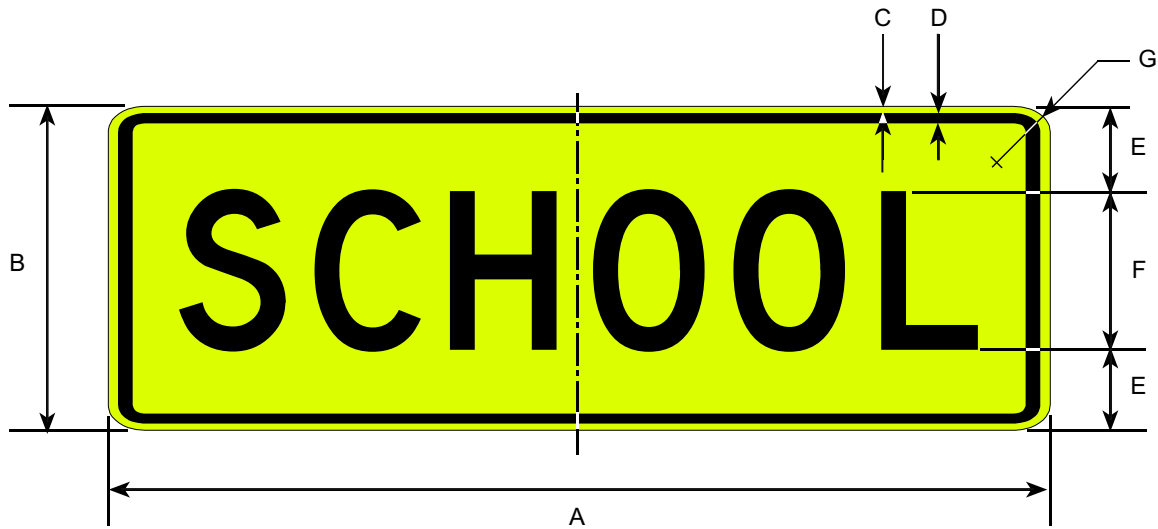

Border and Legend: Black
 Background: Fluorescent Yellow-Green

Road Class	Dimensions (inches)						
	A	B	C	D	E	F	G
Minimum	24	8.0	0.38	0.63	2.0	4D	1.5
Conventional	36	12	0.63	0.88	3.0	6D	2.25
Expwy/Oversized	48	16	0.75	1.25	4.0	8D	3.0

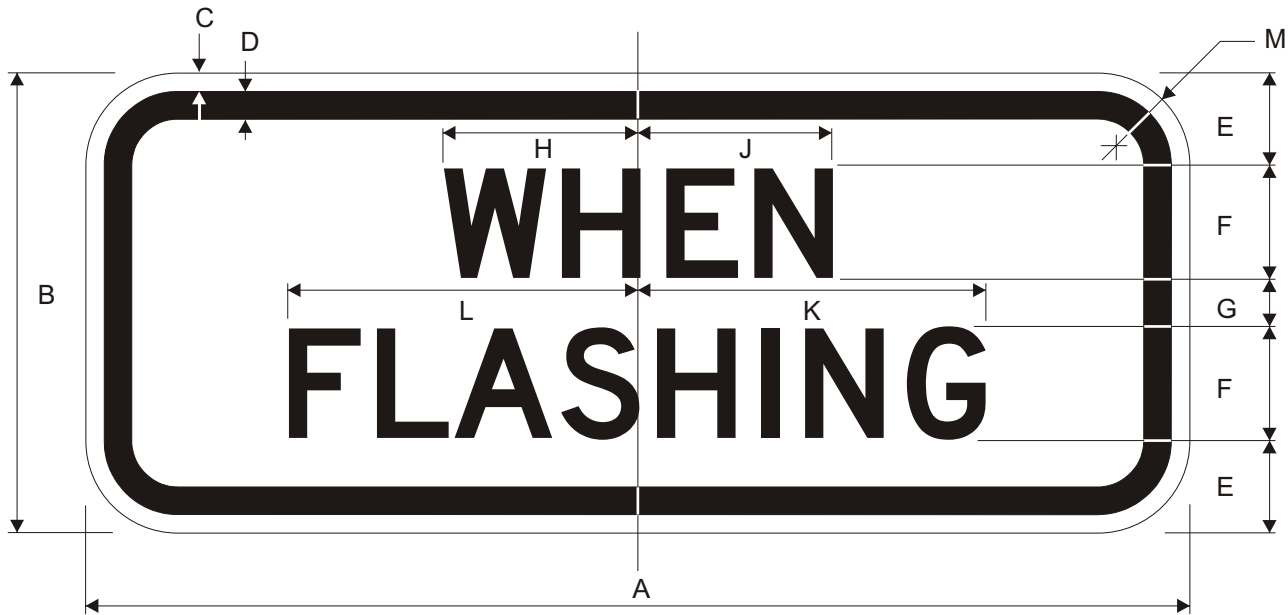

Border and Legend: Black
Background: White

Road Class	Dimensions (inches)											
	A	B	C	D	E	F	G	H	J	K	L	M
Min.	24	10	0.38	0.63	2.0	2.5D	1.0	4.38	4.25	8.06	7.63	1.5
Conv.	36	18	0.63	0.88	3.5	4D	3.0	6.94	6.81	12.94	12.19	2.25
Oversized	42	24	0.75	1.25	5.0	5D	4.0	8.75	8.5	16.13	15.25	3.0

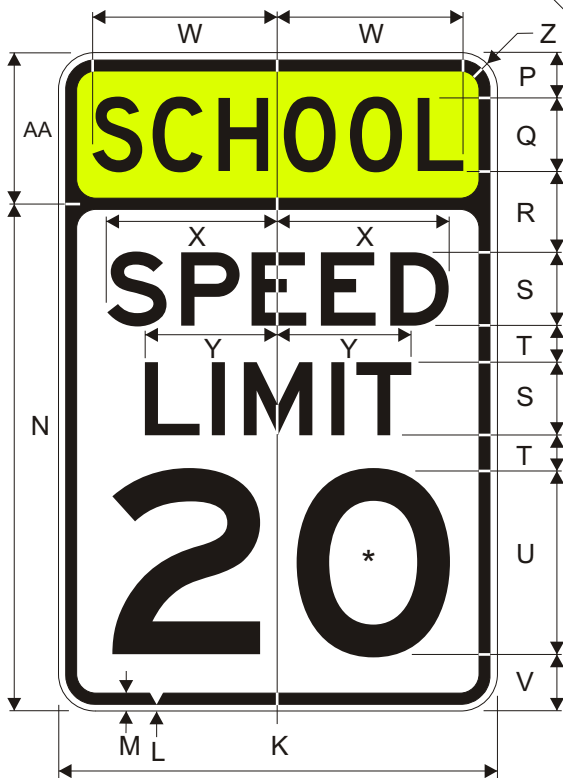
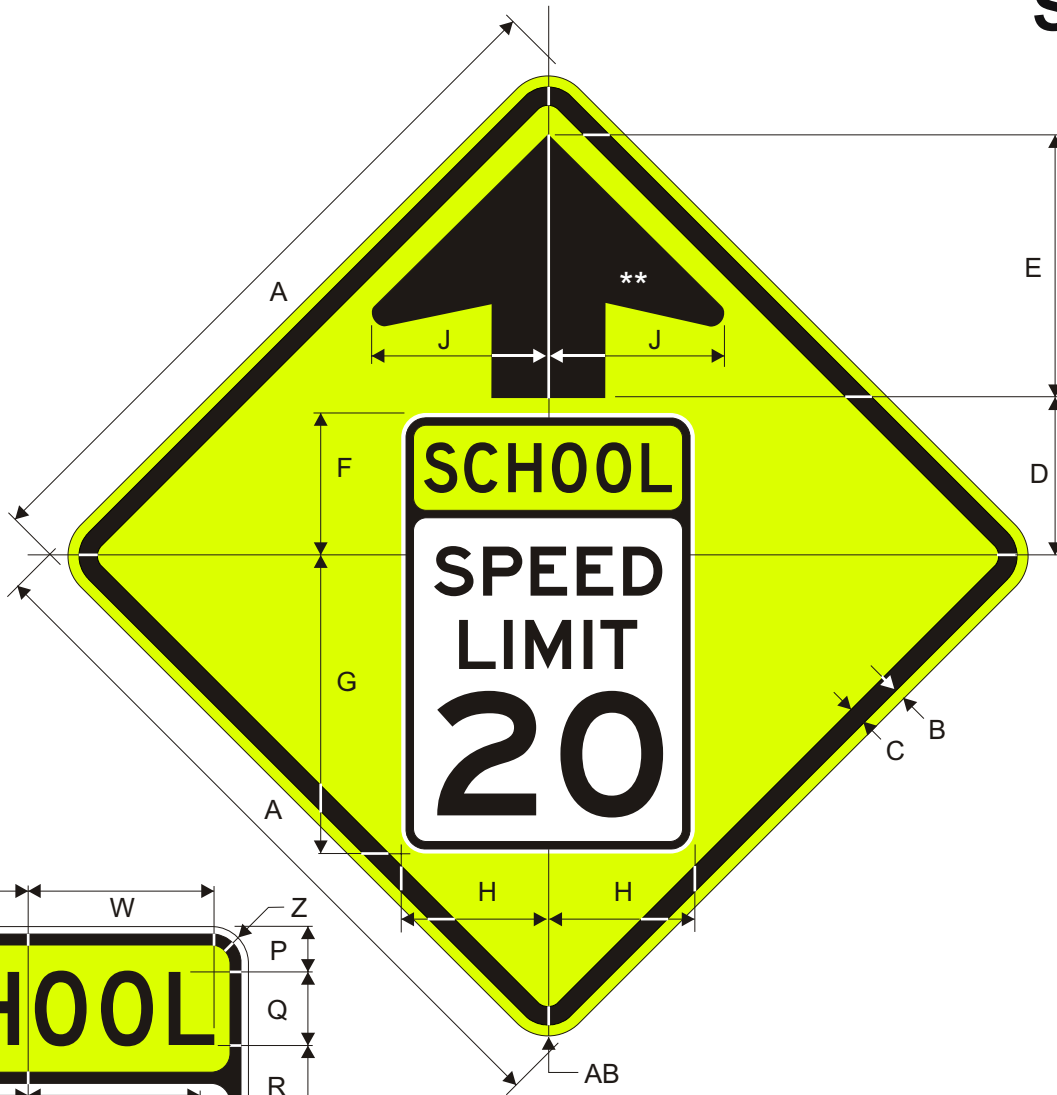

Border and Legend: Black
Background: Fluorescent Yellow-Green

*Optically center numerals about centerline.
**See Appendix B-3 for Standard Arrow Details.

Road Class	Dimensions (inches)							
	A	B	C	D	E	F	G	H
Conv.	36	0.63	0.88	8.25	13.5	7.5	15	7.5
Expy.	48	0.75	1.25	11	18	10	20	10

J	K	L	M	N	P	Q	R	S
9.0	15	0.25	0.38	17.33	1.5	2.5D	2.75	2.5E
12	20	0.30	0.50	23.1	2.0	3.3D	3.7	3.3E

T	U	V	W	X	Y	Z	AA	AB
1.25	6.25	2.0	6.34	5.83	4.55	1.25	5.18	2.25
1.63	8.3E	2.85	8.45	7.78	6.07	1.6	6.9	3.0

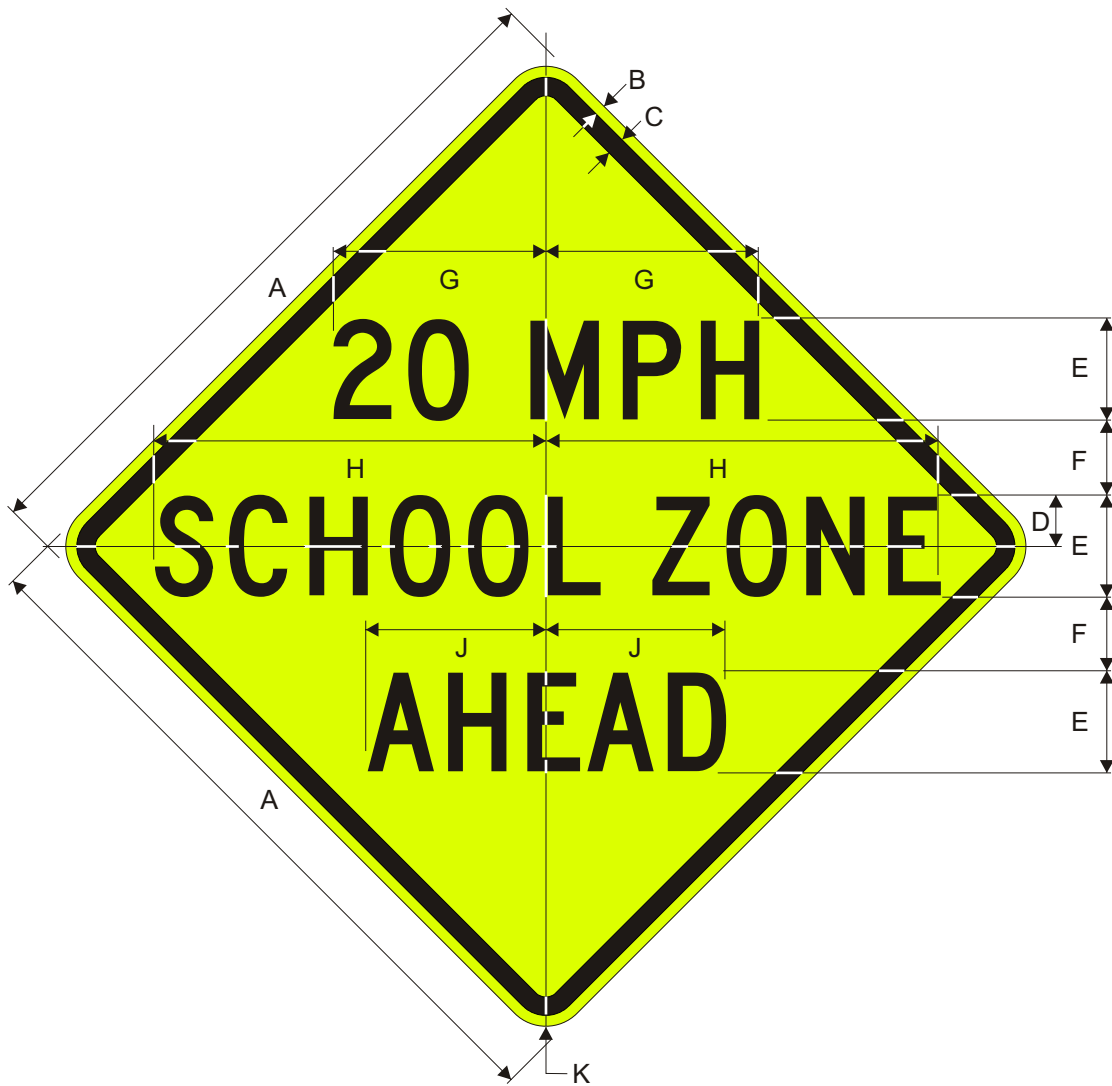

Border and Legend: Black
 Background: Fluorescent Yellow-Green

Road Class	Dimensions (inches)									
	A	B	C	D	E	F	G	H	J	K
Minimum	30	0.5	0.75	2.0	4C	3.5	8.25	15.27	6.97	1.88
Conv.	36	0.63	0.88	2.5	5C	3.5	10.32	19.09	8.71	2.3
Oversized	48	0.75	1.25	3.5	7C	5.0	14.44	26.73	12	3.0

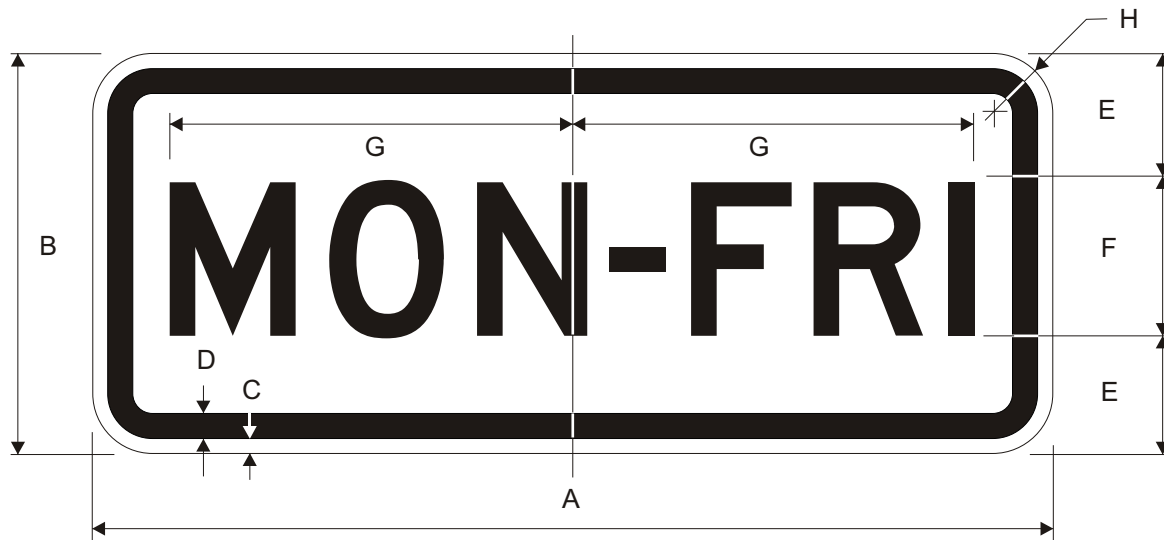

Border and Legend: Black
Background: White

Road Class	Dimensions (inches)							
	A	B	C	D	E	F	G	H
Min/Conv	24	10	0.38	0.63	3.0	4D	10	1.5
Oversized	36	18	0.63	0.88	6.0	6D	15	2.25

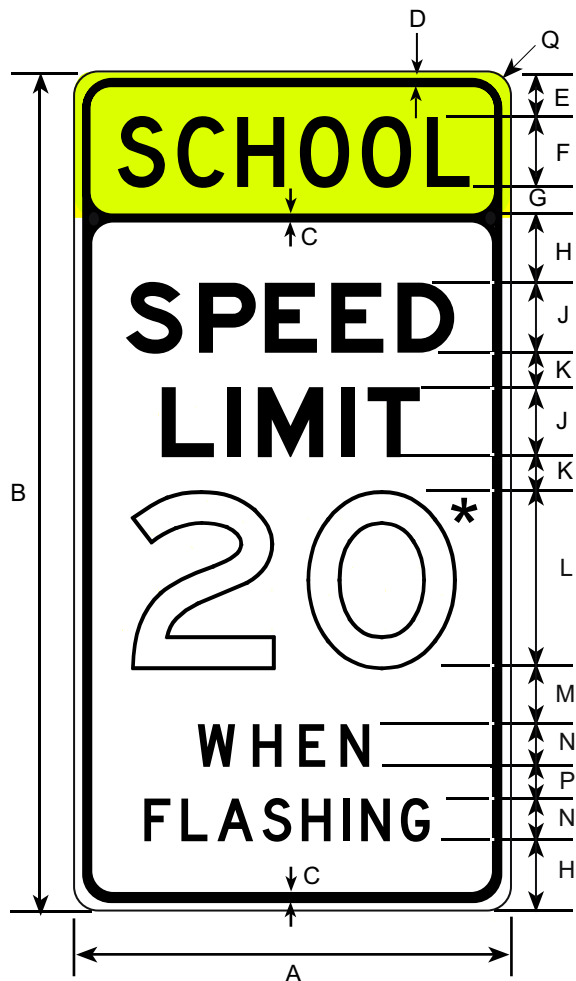

* Optically space numerals about vertical center line.

Border and Legend: Black
 Upper Background: Fluorescent Yellow-Green
 Lower Background: White

Speed limit is variable.

Road Class	Dimensions (inches)									
	A	B	C	D	E	F	G	H	J	K
Minimum	24	48	0.38	0.63	2.5	4D	1.5	4.0	4E	2.0
Conventional	36	72	0.63	0.88	3.75	6D	2.25	6.0	6E	4.0
Oversized	48	96	0.75	1.25	5.0	8D	3.0	8.0	8E	6.0
	L	M	N	P	Q					
	10E	3.0	2.5D	2.0	1.5					
	14E	4.0	4D	2.0	2.25					
	16E	6.0	5D	4.0	3.0					

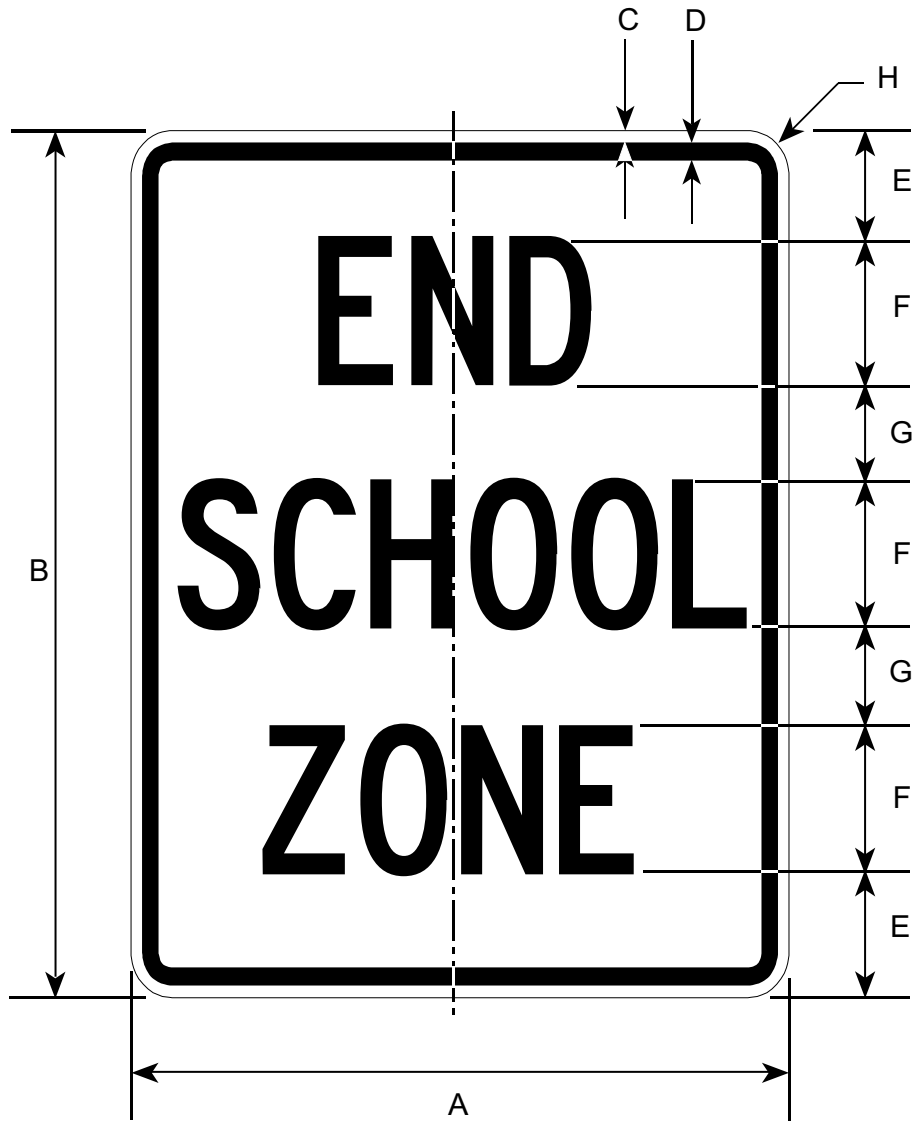

Border and Legend: Black
Background: White

Road Class	Dimensions (inches)							
	A	B	C	D	E	F	G	H
Minimum	18	24	0.38	0.63	3.5	4C	2.5	1.50
Conventional	24	30	0.38	0.63	4.0	5C	3.5	1.50
Oversized	36	48	0.63	0.88	6.5	8C	5.5	2.25

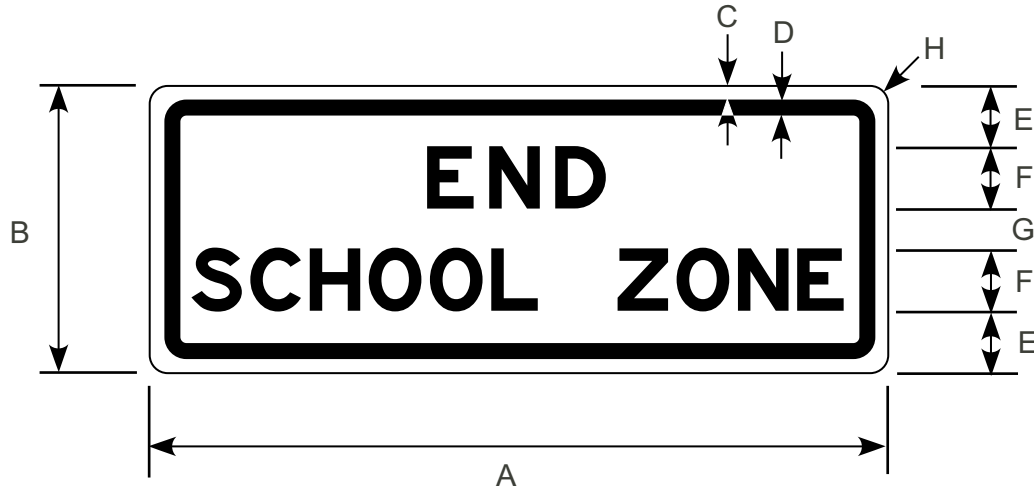

Prior to 2002 publication of this manual, this sign was numbered S6-1.

Border and Legend: Black
Background: White

Road Class	Dimensions (inches)							
	A	B	C	D	E	F	G	H
Minimum	24	10	0.38	0.63	2.25	2E	1.5	1.50
Conventional	30	12	0.50	0.75	2.75	2E	2.5	1.88
Expwy/Oversized	36	14	0.63	0.88	3.00	3E	2.0	2.25

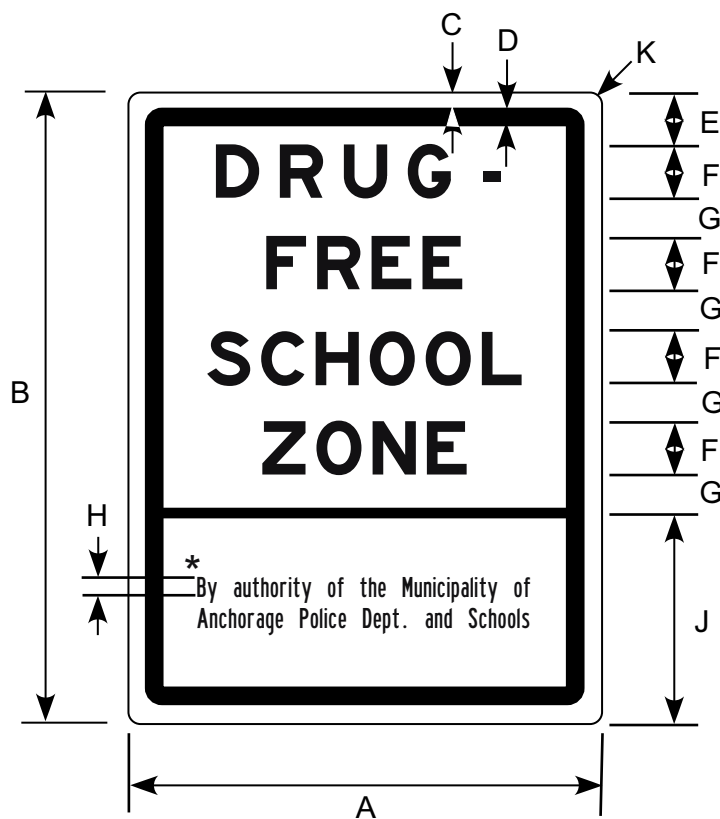

Border and Legend: Black
Background: White

* Legend is variable.

Road Class	Dimensions (inches)									
	A	B	C	D	E	F	G	H	J	K
Conventional	18	24	0.5	0.75	2	2E	1.5	.75B	8	1.5

WARNING SIGNS

W1-1 to W25-2

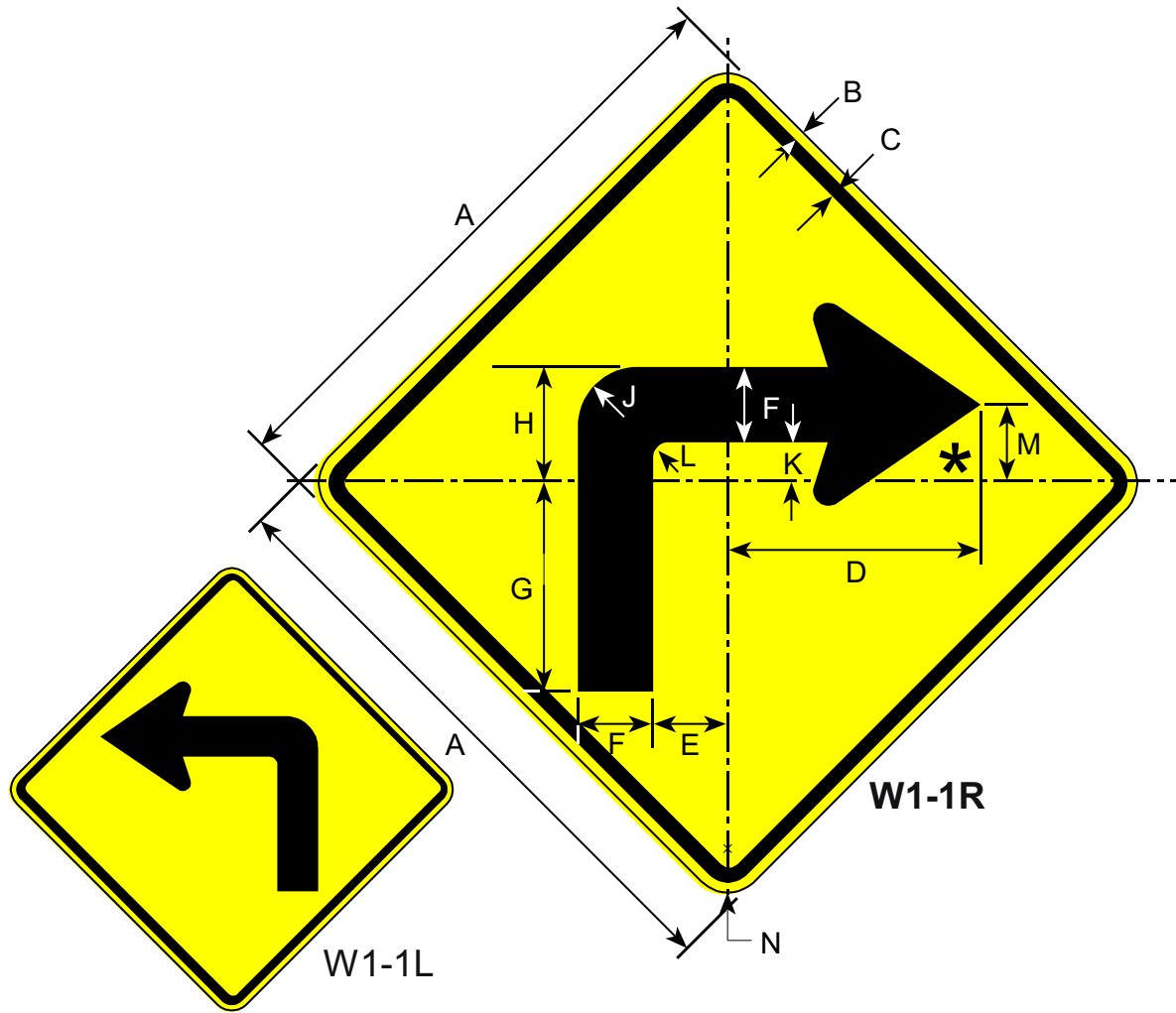

Border and Legend: Black
Background: Yellow

* See Appendix B-1 for Standard Arrow Details.

Road Class	Dimensions (inches)												
	A	B	C	D	E	F	G	H	J	K	L	M	N
Bike	18	0.38	0.63	7.25	2.25	2.63	5.88	3.75	1.88	1.0	0.63	2.5	1.5
Minimum	30	0.50	0.75	12	3.75	4.38	9.0	6.25	3.0	1.88	1.0	4.06	1.88
Conventional	36	0.63	0.88	14.38	4.5	5.25	11	7.5	3.63	2.25	1.25	4.88	2.25
Expwy/Fwy	48	0.75	1.25	19.19	6.0	7.0	15.5	10	4.88	3.0	1.63	6.5	3.0

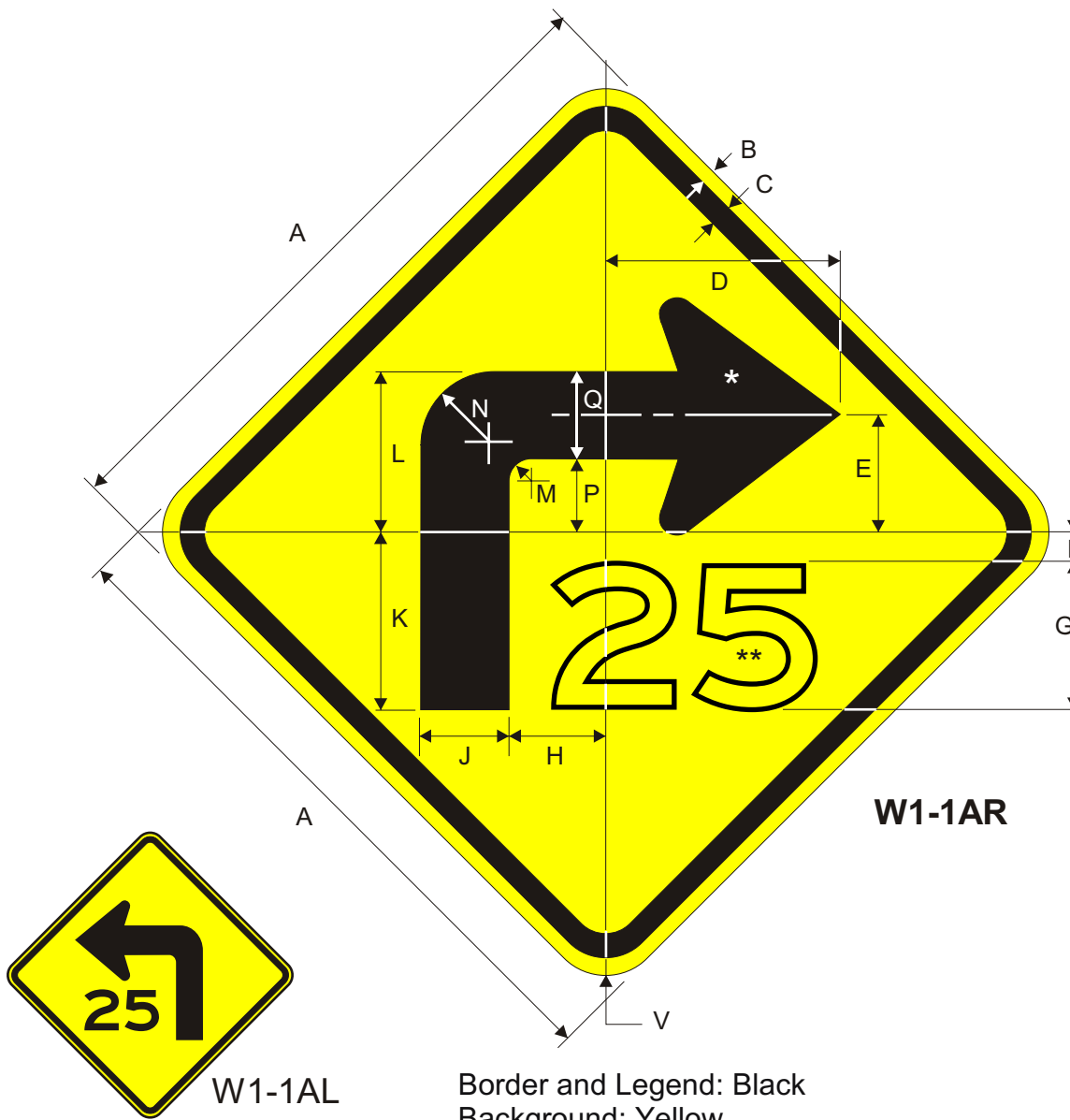

Border and Legend: Black
Background: Yellow

* See Appendix B-1 for Standard Arrow Details.

**Optically locate numerals.

Road Class	Dimensions (inches)										
	A	B	C	D	E	F	G	H	J	K	L
Minimum	30	0.50	0.75	10.65	5.25	2.0	6E	4.36	4.0	8.0	7.28
Conventional	36	0.63	0.88	13.33	6.65	2.92	7E	5.44	5.0	9.93	9.12
Expy/Fwy	48	0.75	1.25	18.65	9.33	5.04	9E	7.61	7.0	14.05	12.84

N	P	Q	R
3.2	3.28	4.0	1.88
4.0	4.12	5.0	2.25

W1-2 W1-2A

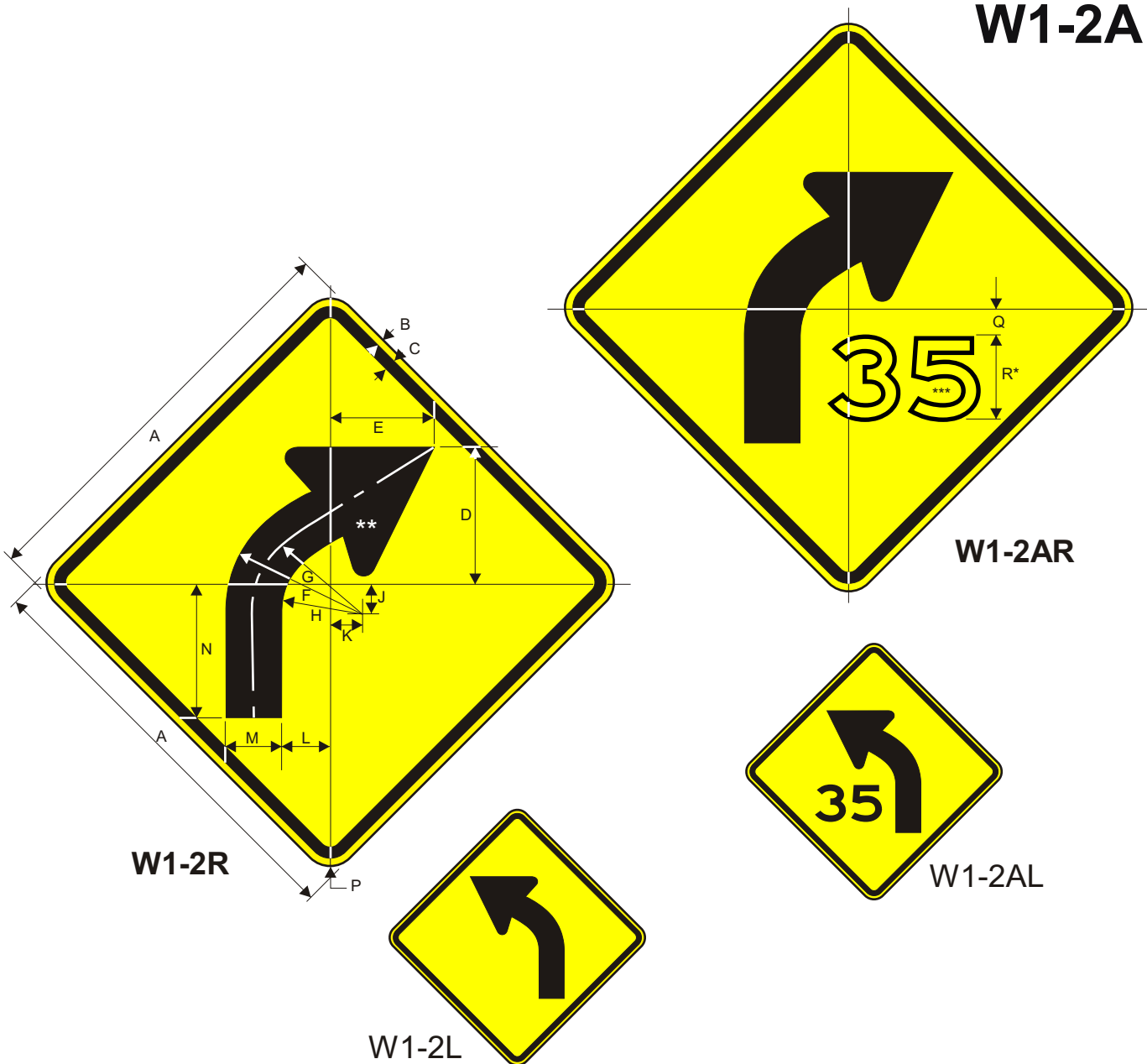

Border and Legend: Black
Background: Yellow

*See Appendix B-1 for Standard Arrow Details.
**Optically position numerals.

Road Class	Dimensions (inches)															
	A	B	C	D	E	F	G	H	J	K	L	M	N	P	Q	R
Bike	18	0.38	0.63	5.41	5.14	6.0	4.69	3.38	1.8	1.31	2.06	2.63	6.19	1.5	1.5	4E
Minimum	24	0.38	0.63	7.09	7.25	8.0	6.25	4.5	2.3	1.75	2.75	3.5	8.3	1.5	2.5	5E
Conventional	30	0.5	0.75	8.88	9.06	10	7.81	5.63	2.9	2.19	2.44	4.38	10.31	1.88	2.0	6E
Expy/Fwy	36	0.63	0.88	10.63	10.88	12	9.38	6.75	3.5	2.63	4.13	5.25	12.38	2.25	3.0	7E
Oversized	48	0.75	1.25	14.19	14.5	16	12.5	9.0	4.7	3.5	5.5	7.0	16.5	3.0	5.0	9E

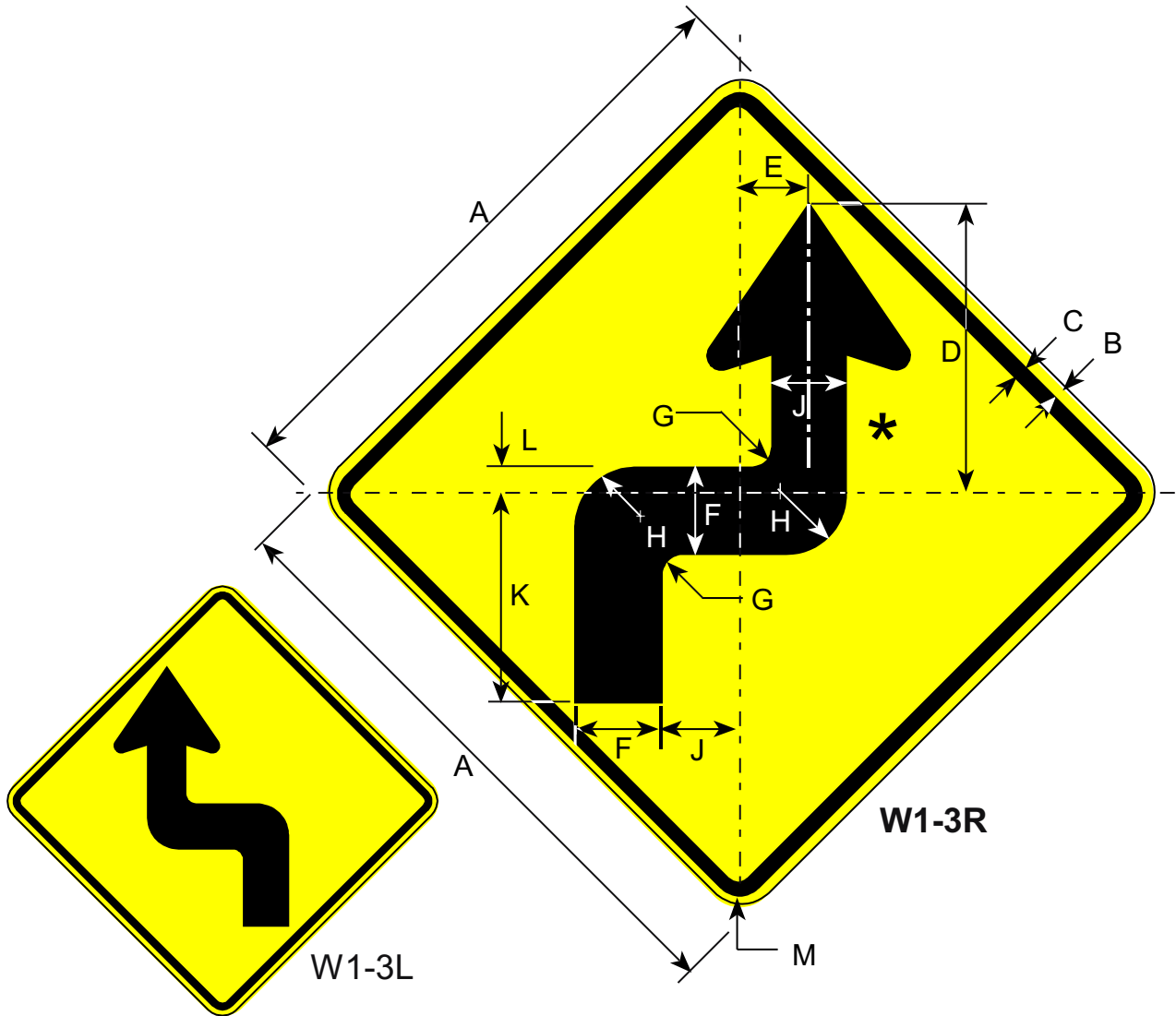

Border and Legend: Black
Background: Yellow

* See Appendix B-1 for Standard Arrow Details.

Road Class	Dimensions (inches)											
	A	B	C	D	E	F	G	H	J	K	L	M
Bike	24	0.38	0.63	11	2.81	3.5	0.81	2.5	3.0	8.31	1.09	1.5
Minimum	30	0.50	0.75	14.50	3.5	4.38	1.0	3.0	3.75	10.38	1.38	1.88
Conventional	36	0.63	0.88	17.44	4.22	5.25	1.25	3.63	4.5	12.47	1.66	2.25
Expwy/Fwy	48	0.75	1.25	23.19	5.63	7.0	1.63	4.88	6.0	16.63	2.19	3.0

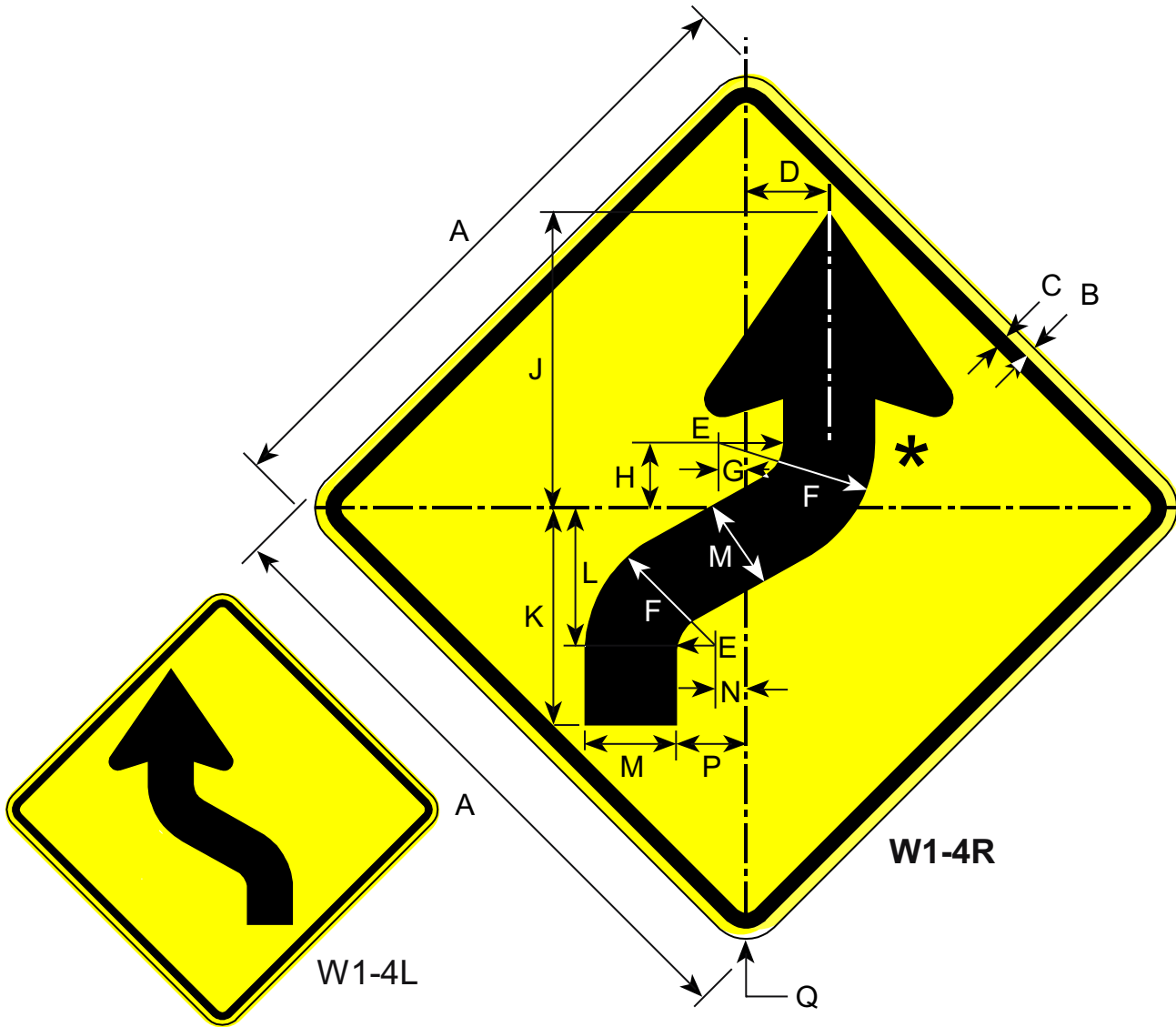

Border and Legend: Black
Background: Yellow

* See Appendix B-1 for Standard Arrow Details.

Road Class	Dimensions (inches)														
	A	B	C	D	E	F	G	H	J	K	L	M	N	P	Q
Bike	18	0.50	0.63	2.38	1.13	3.75	0.06	2.63	8.63	6.25	4.0	2.63	0.88	2.0	1.5
Minimum	30	0.50	0.75	3.94	1.88	6.25	0.13	4.38	14.06	10.94	6.56	4.38	1.81	3.28	1.88
Conventional	36	0.63	0.88	4.72	2.25	7.5	0.15	5.25	16.88	12.38	7.88	5.25	1.0	3.94	2.25
Expwy/Fwy	48	0.75	1.25	6.31	3.0	10	0.19	7.0	22.5	16.5	10.5	7.0	2.25	5.25	3.0

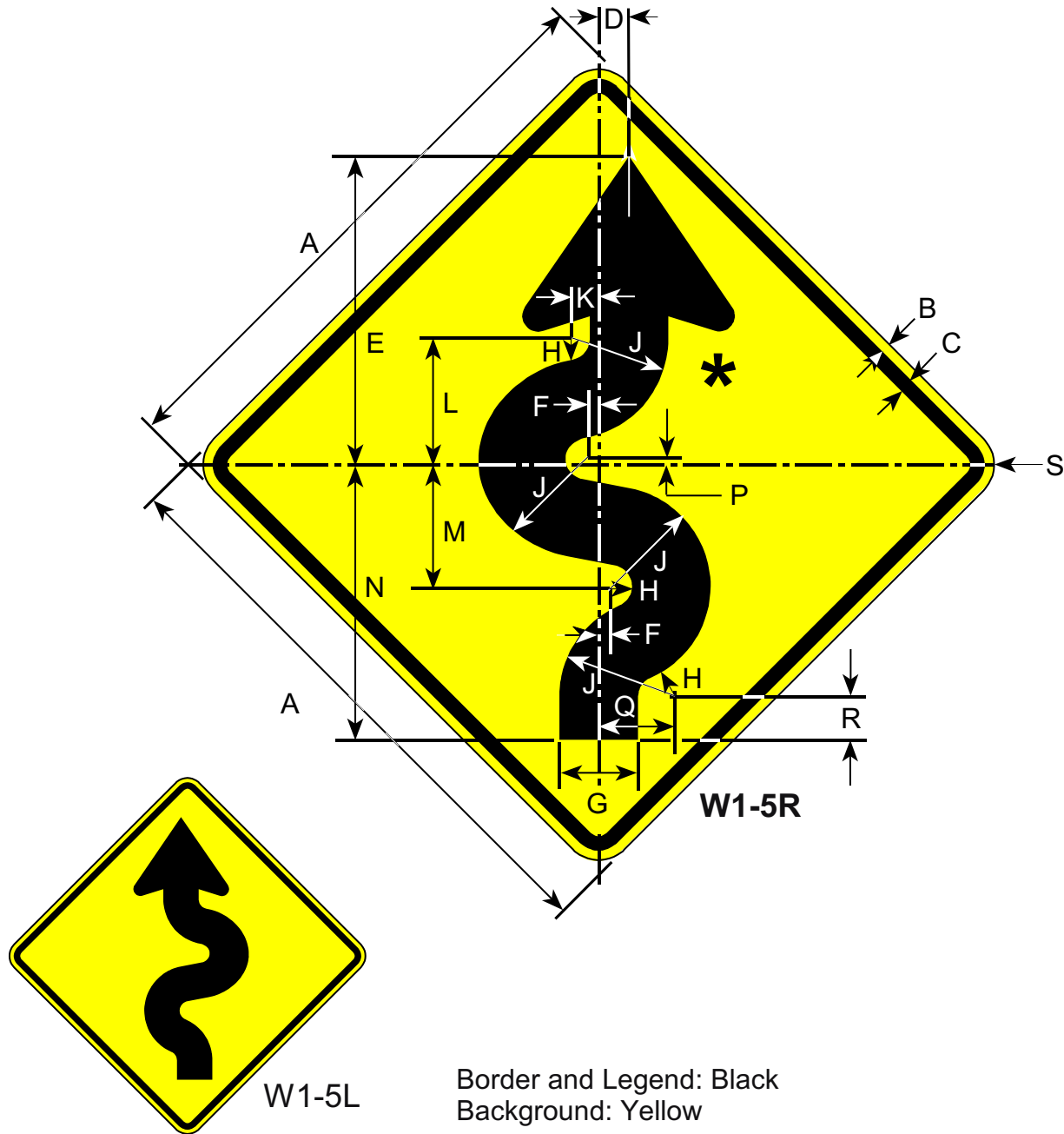

* See Appendix B-1 for Standard Arrow Details.

Road Class	Dimensions (inches)															
	A	B	C	D	E	F	G	H	J	K	L	M	N	P	Q	R
Bike	18	0.38	0.63	1.0	9.63	0.38	2.5	0.63	3.0	1.0	4.0	4.0	8.63	0.25	2.0	1.25
Minimum	30	0.50	0.75	1.56	15.06	0.63	4.06	1.09	5.16	1.56	6.56	6.56	14.22	0.31	3.13	2.0
Conventional	36	0.63	0.88	1.88	19.13	0.75	4.88	1.31	6.19	1.88	7.78	7.88	17.06	0.38	3.75	2.41
Expwy/Fwy	48	0.75	1.25	2.5	25.5	1.0	6.5	1.75	8.25	2.5	10.38	10.5	22.75	0.50	5.0	3.19

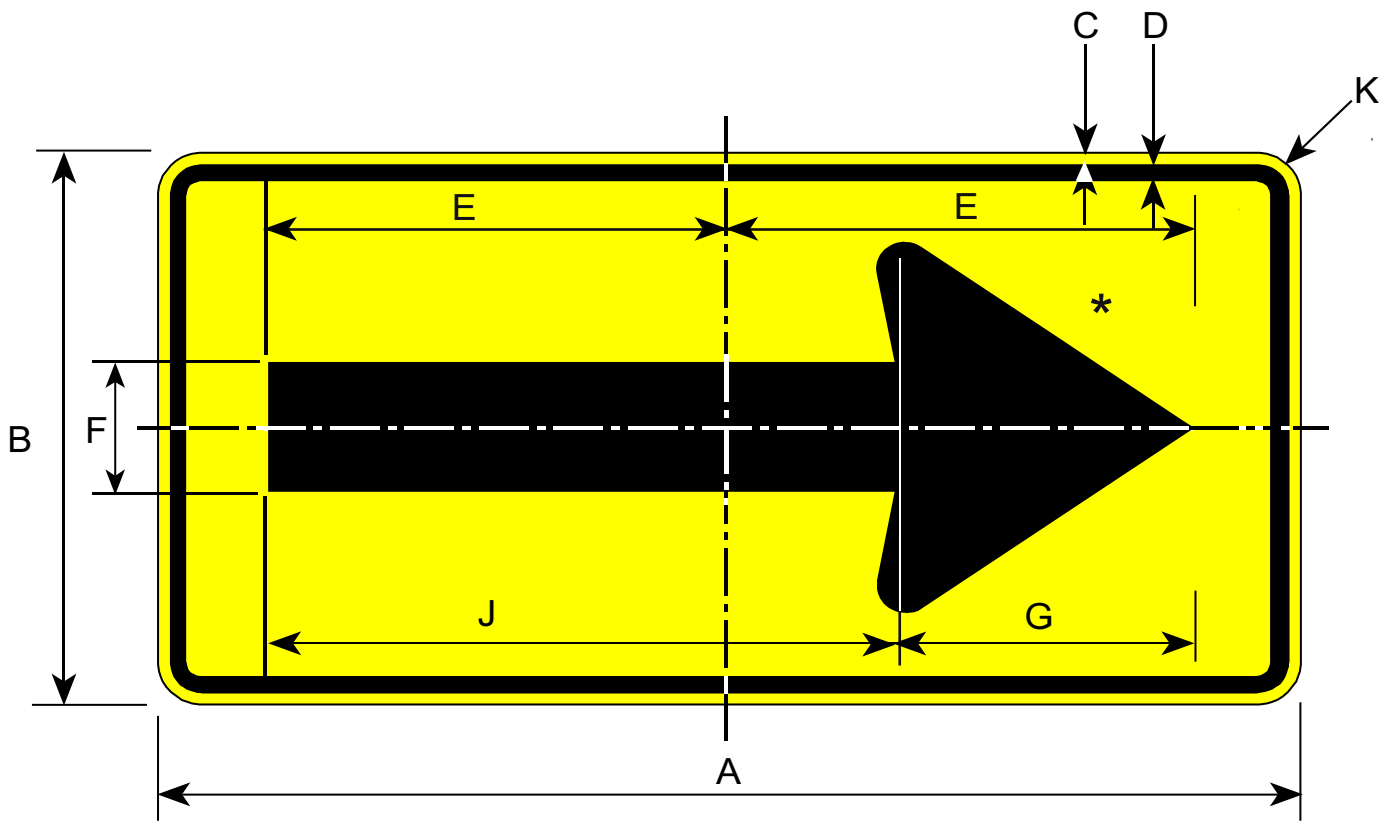

W1-6R

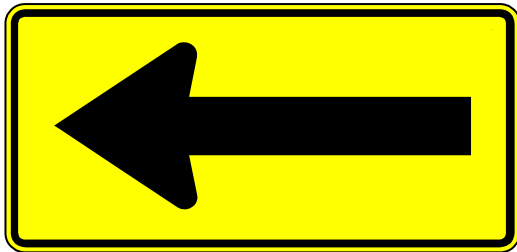

W1-6L

Border and Legend: Black
Background: Yellow

* See Appendix B-1 for Standard Arrow Details.

Road Class	Dimensions (inches)								
	A	B	C	D	E	F	G	J	K
Minimum	36	18	0.38	0.63	14.63	5.0	10.13	19.13	1.5
Conventional	48	24	0.50	0.75	19.5	6.5	13.19	25.81	1.88
Expwy/Fwy	60	30	0.63	0.88	24.38	8.0	16.25	32.5	2.25

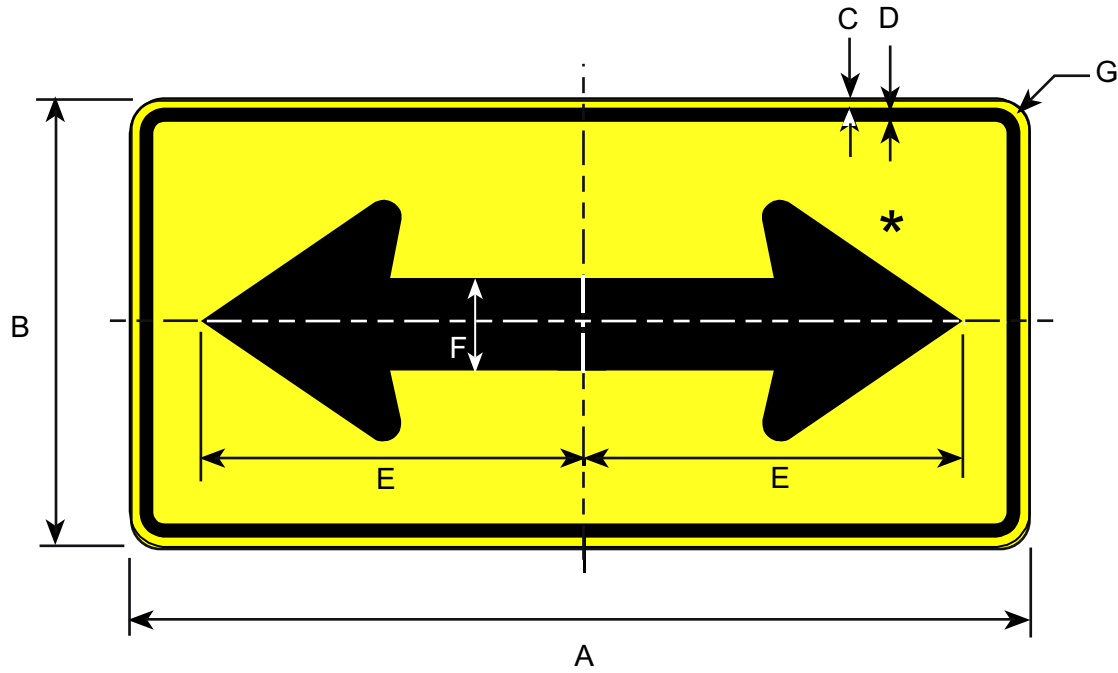

Border and Legend: Black
 Background: Yellow

* See Appendix B-1 for Standard Arrow Details.

Road Class	Dimensions (inches)						
	A	B	C	D	E	F	G
Bike	24	12	0.38	0.63	10.38	3.25	1.50
Minimum	36	18	0.38	0.63	15.63	5.00	1.50
Conventional	48	24	0.50	0.75	20.50	6.50	1.88
Expwy/Fwy	60	30	0.63	0.88	25.38	8.00	2.25
Oversized	96	48	0.75	1.25	41.00	12.50	3.00

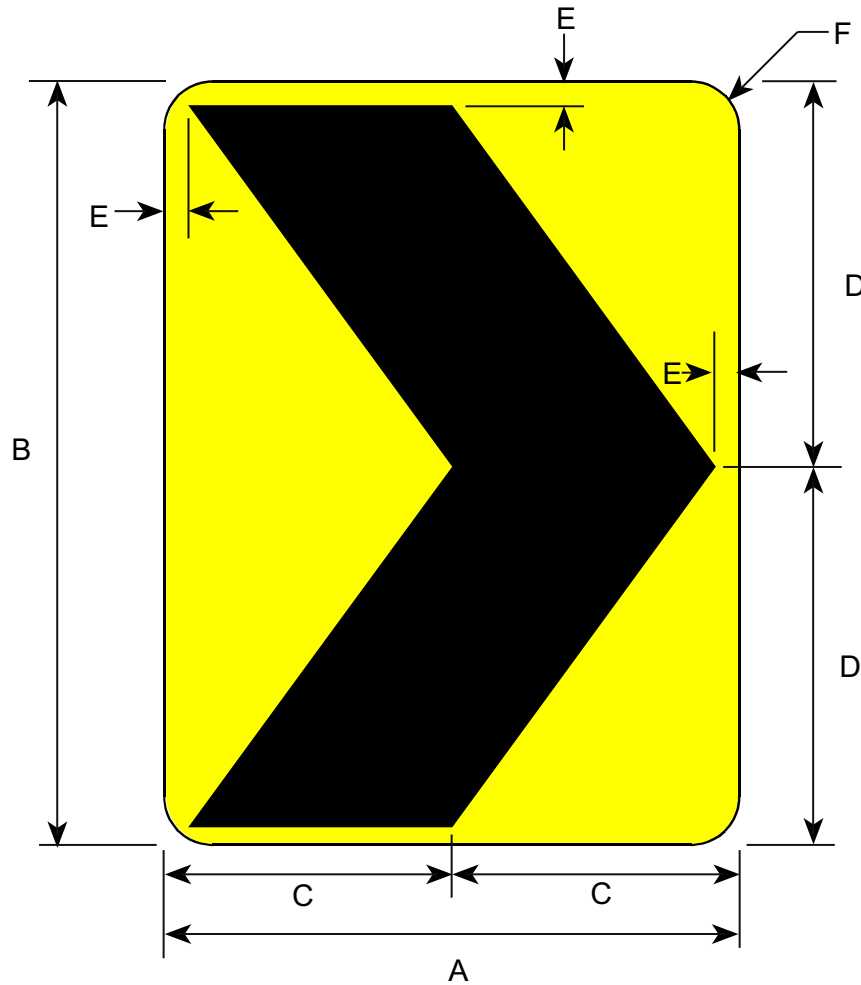

Border and Legend: Black
Background: Yellow

Make symbol proportional
to the one shown.

Road Class	Dimensions (inches)					
	A	B	C	D	E	F
Bike	12	18	6	9	0.50	1.50
Minimum	18	24	9	12	0.75	1.50
Conventional	24	30	12	15	0.88	1.50
Expwy	30	36	15	18	1.00	1.88
Freeway	36	48	18	24	1.13	2.25

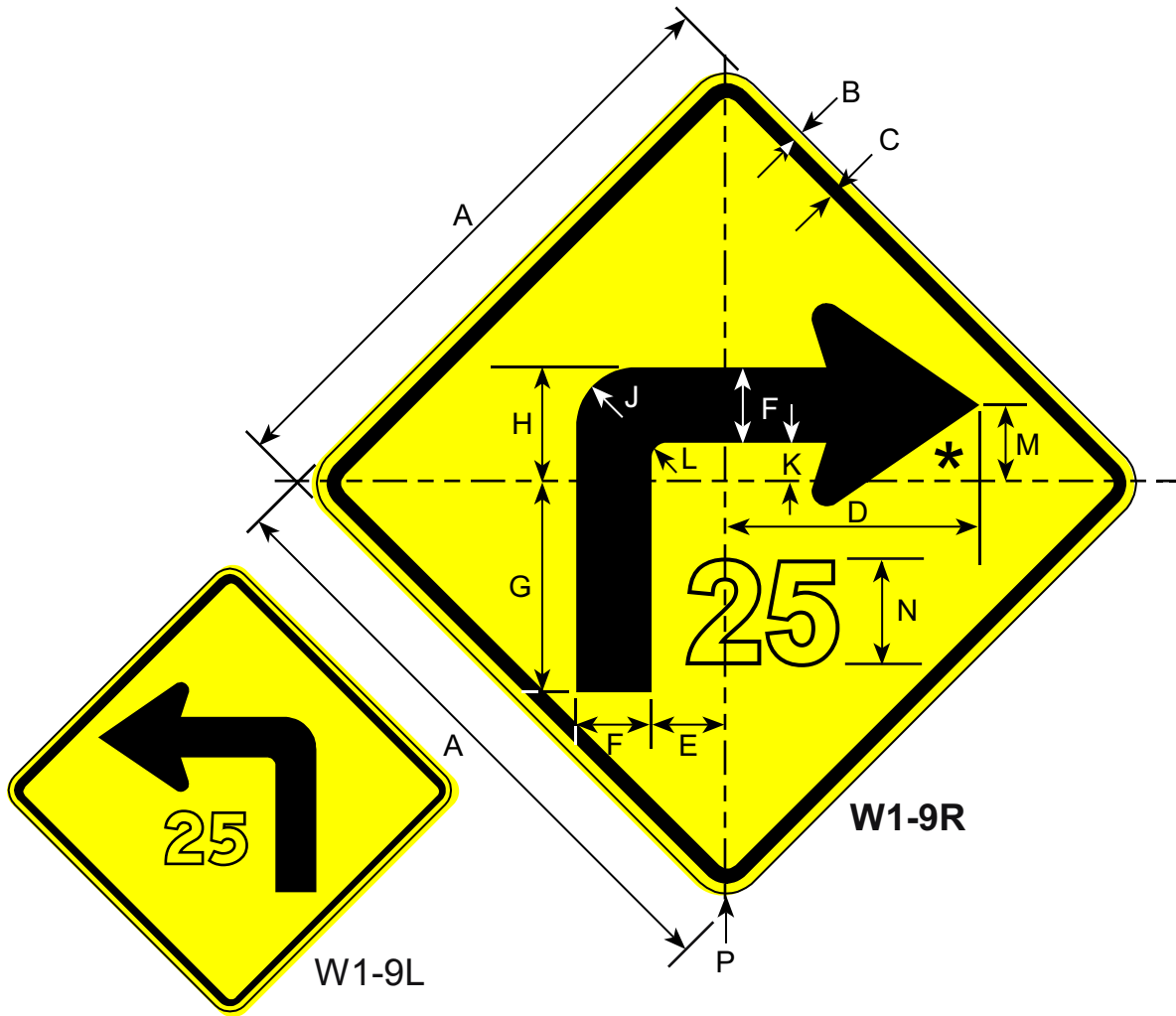

Border and Legend: Black
Background: Yellow

* See Appendix B-1 for Standard Arrow Details.

Road Class	Dimensions (inches)													
	A	B	C	D	E	F	G	H	J	K	L	M	N	P
Bike	18	0.38	0.63	7.25	2.25	2.63	5.88	3.75	1.88	1.0	0.63	2.5	4E	1.5
Conv & Min	36	0.63	0.88	14.38	4.5	5.25	11	7.5	3.63	2.25	1.25	4.88	7E	2.25
45 MPH, or Greater	48	0.75	1.25	19.19	6.0	7.0	15.5	10	4.88	3.0	1.63	6.5	9E	3.0

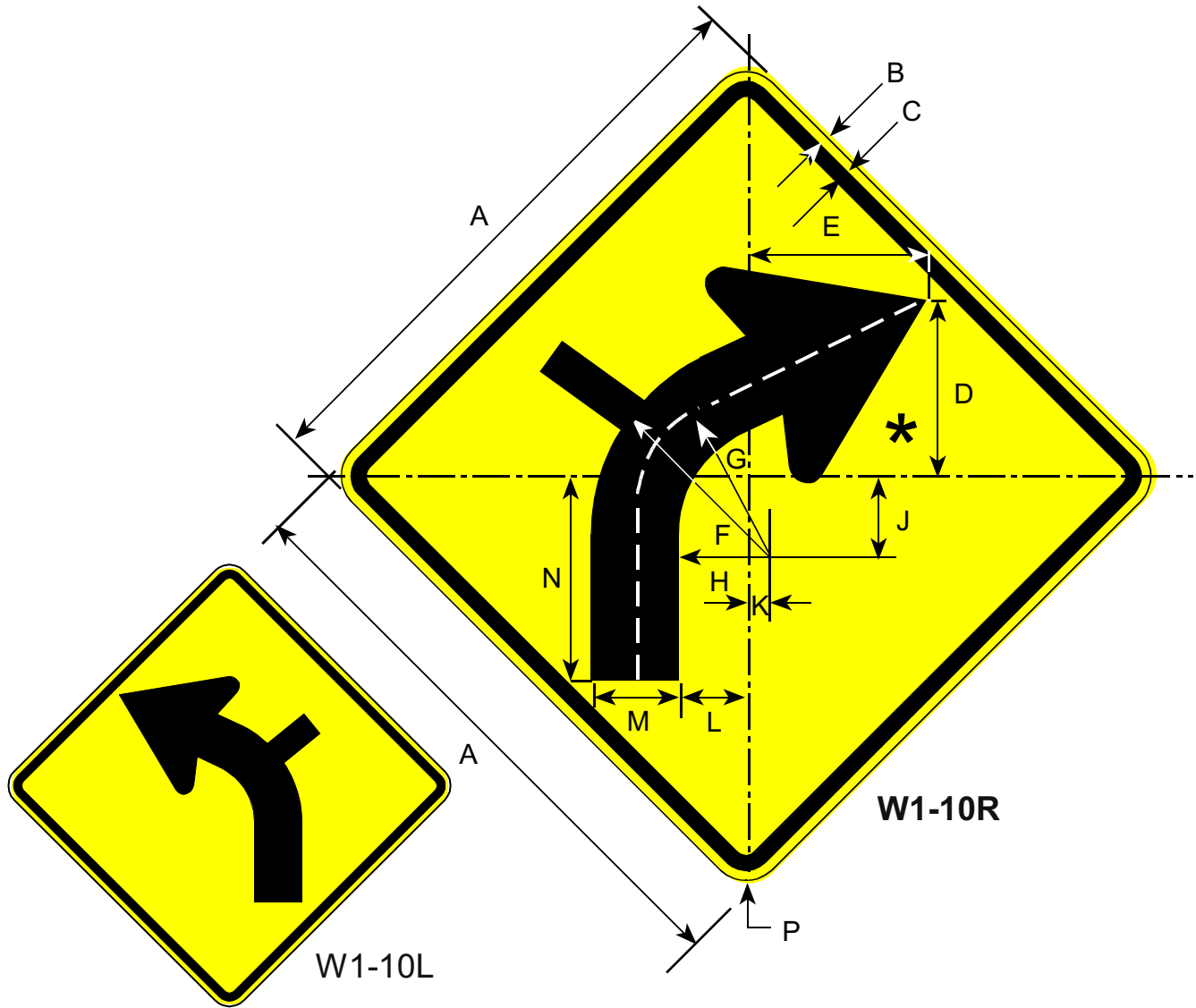

Border and Legend: Black
Background: Yellow

* See Appendix B-1 for Standard Arrow Details.

Road Class	Dimensions (inches)														
	A	B	C	D	E	F	G	H	J	K	L	M	N	P	
Bike	18	0.38	0.63	5.38	5.5	6.0	4.75	3.38	1.75	1.25	2.0	2.63	6.25	1.5	
Minimum	30	0.50	0.75	8.88	9.06	10	7.81	5.63	2.94	2.19	3.44	4.38	10.31	1.88	
Conventional	36	0.63	0.88	10.88	10.88	12	9.38	6.75	3.5	2.63	4.25	5.25	12.38	2.25	
Expwy/Fwy	48	0.75	1.25	14.81	14.25	16	12.5	9.0	4.0	3.5	5.5	7.0	16.5	3.0	

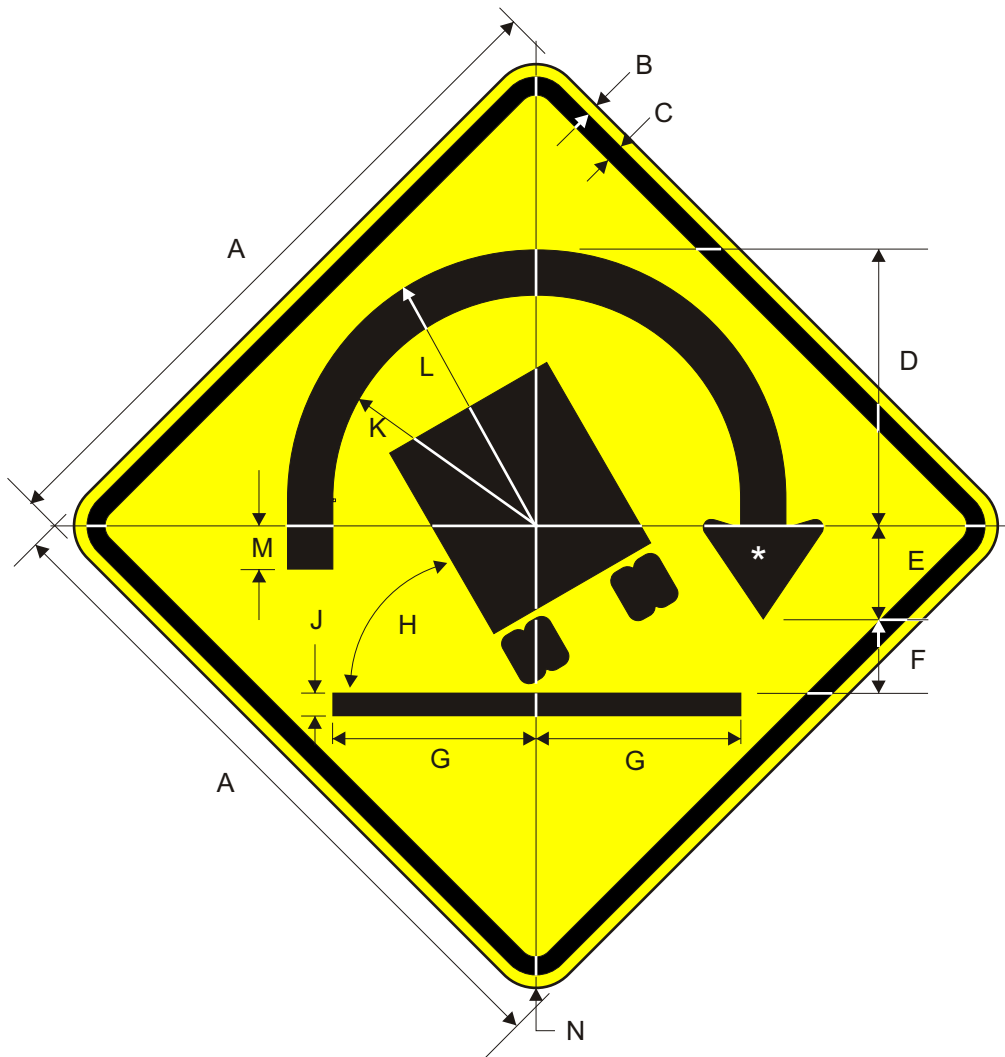

Border and Legend: Black
Background: Yellow

* See Appendix B-1 for Standard Arrow Details.

Road Class	Dimensions (inches)												
	A	B	C	D	E	F	G	H	J	K	L	M	N
Minimum	30	0.50	0.75	12.21	4.12	3.32	9.05	60°	0.96	10.21	12.21	1.92	1.88
Conventional	36	0.63	0.88	14.65	4.96	4.0	10.85	60°	1.16	12.25	14.65	2.32	2.25
Expy/Fwy	48	0.75	1.25	19.53	6.61	5.32	14.49	60°	1.52	16.33	19.53	3.08	3.0

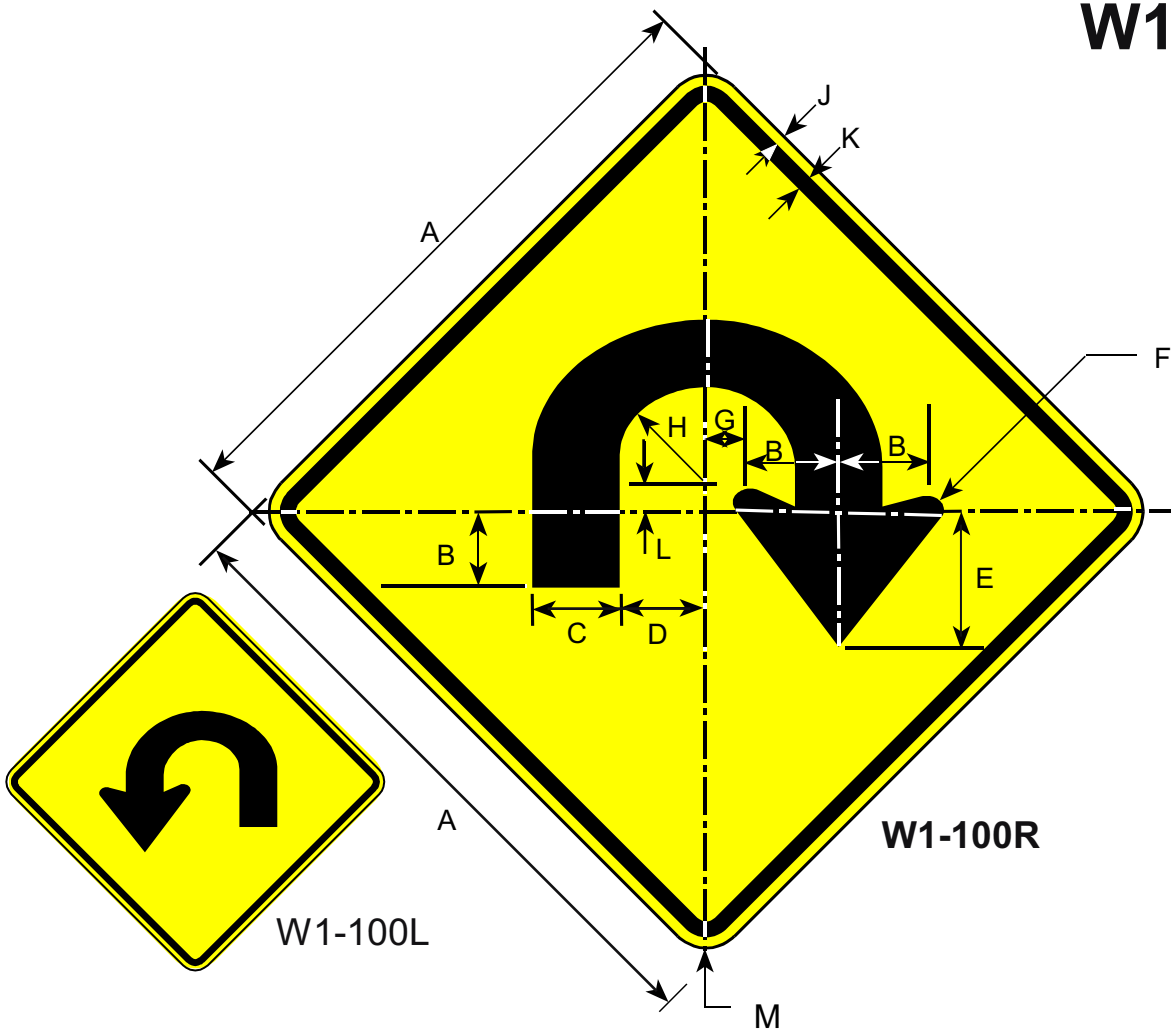

Border and Legend: Black
Background: Yellow

* See Appendix B-1 for Standard Arrow Details.

Prior to 2002 publication of this manual, this sign was numbered W1-9.

Road Class	Dimensions (inches)												
	A	B	C	D	E	F	G	H	J	K	L	M	
Minimum	30	5.0	4.38	5.75	8.75	0.75	0.25	7.0	0.88	0.50	0.75	1.88	
Conventional	36	6.0	5.25	6.88	10.5	0.94	0.30	7.5	1.13	0.63	0.88	2.25	
Expwy/Fwy	48	8.0	7.0	9.25	14	1.19	0.38	9.0	1.5	0.75	1.25	3.0	

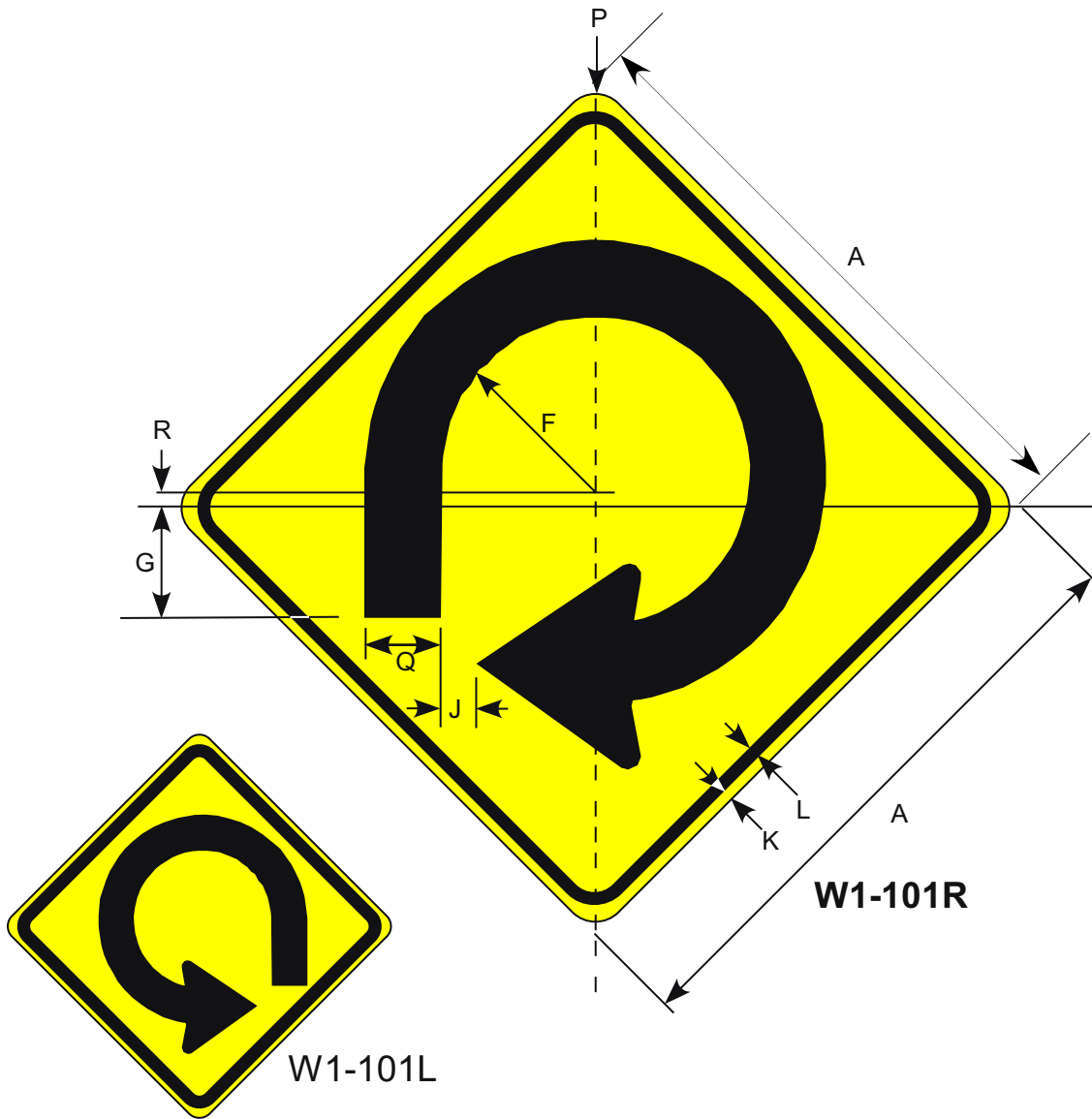

Border and Legend: Black
Background: Yellow

* See Appendix B-1 for Standard Arrow Details.

Prior to 2002 publication of this manual, this sign was numbered W1-10.

Road Class	Dimensions (inches)								
	A	F	G	J	K	L	P	Q	R
Minimum	30	8.13	6.56	2.0	0.75	0.50	1.88	3.75	0.94
Standard	36	9.75	0.88	2.38	0.88	0.63	2.25	4.5	1.13
Expwy/Fwy	48	13	10.5	3.13	1.25	0.75	3.0	6.0	1.5

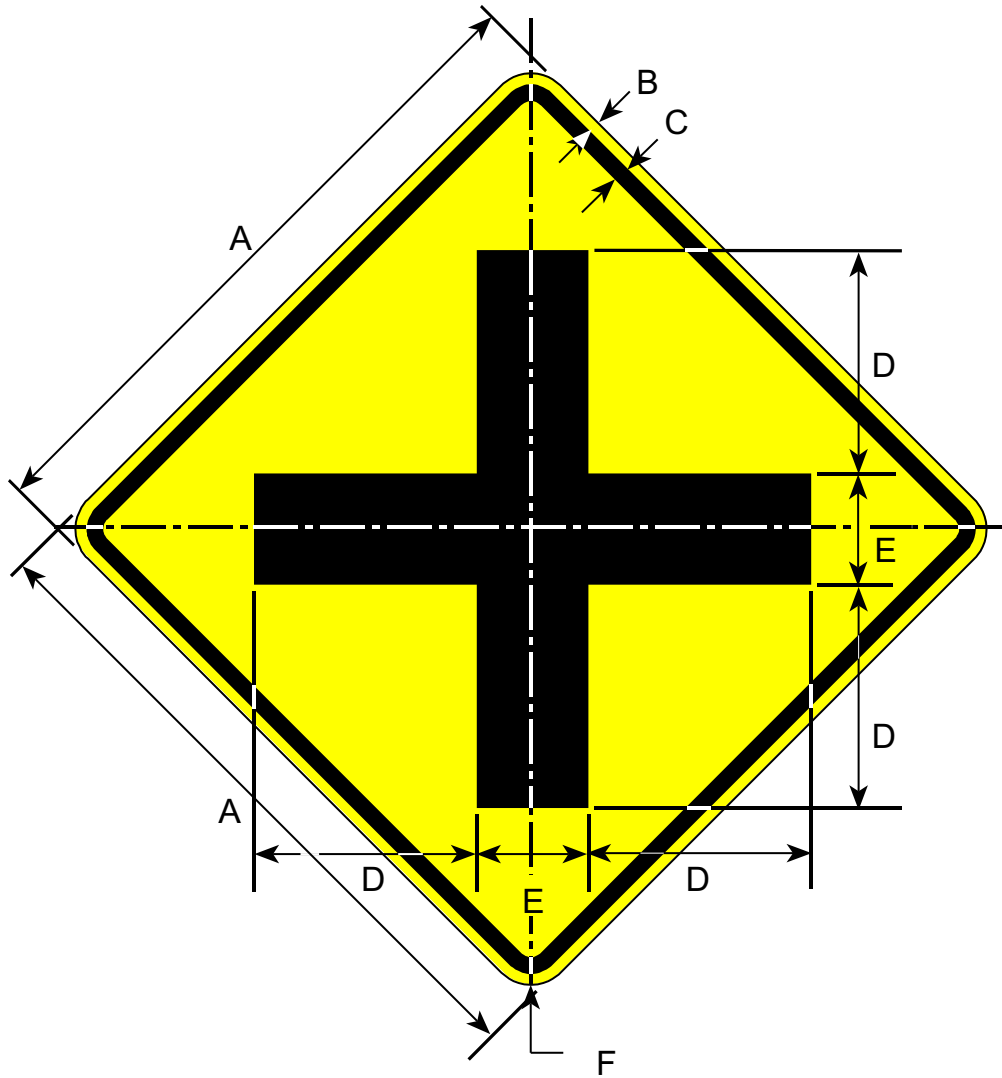

Border and Legend: Black
Background: Yellow

Road Class	Dimensions (inches)					
	A	B	C	D	E	F
Bike	18	0.38	0.63	6	3	1.50
Minimum	30	0.50	0.75	10	5	1.88
Conventional	36	0.63	0.88	12	6	2.25
Expwy/Fwy	48	0.75	1.25	16	8	3.00

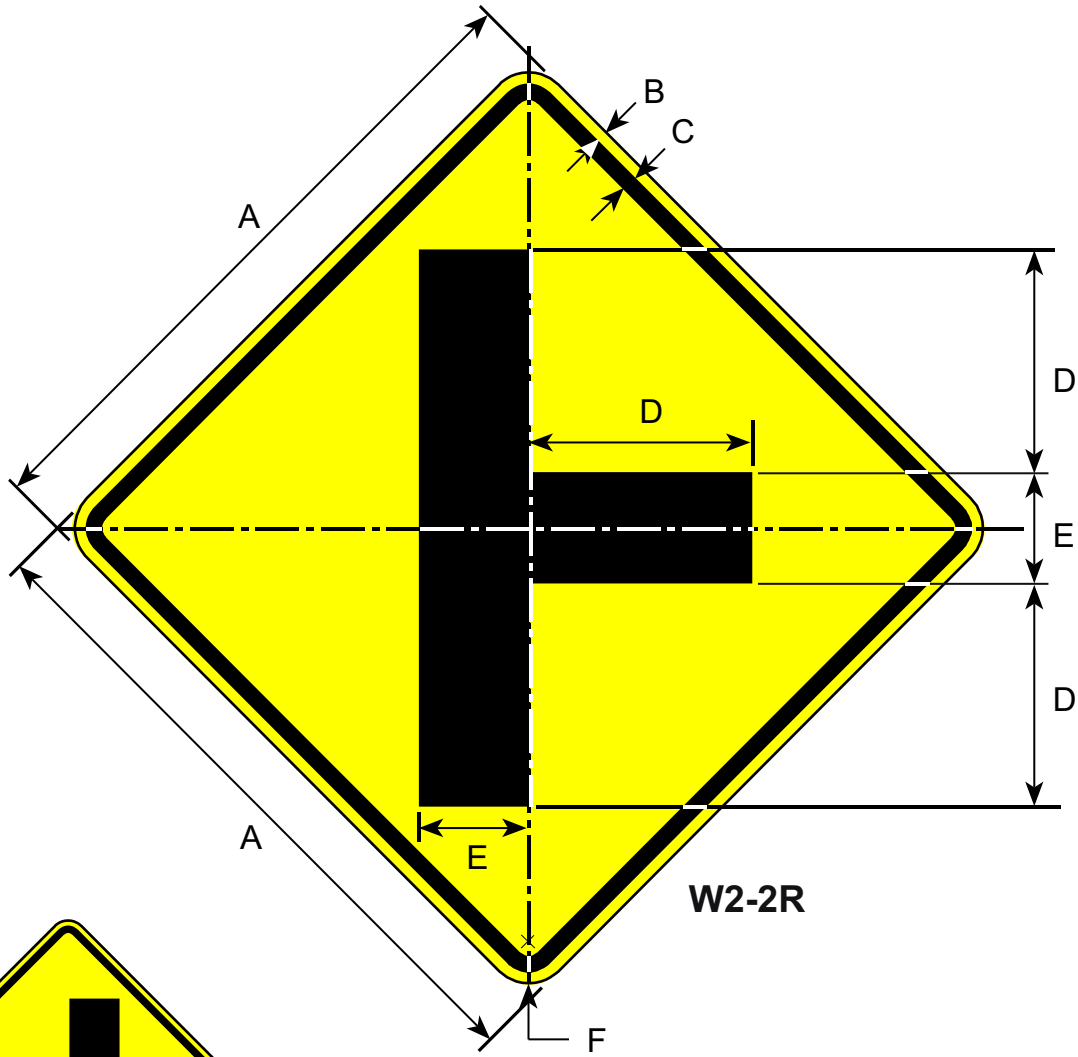

W2-2R



W2-2L

Border and Legend: Black
Background: Yellow

Road Class	Dimensions (inches)					
	A	B	C	D	E	F
Bike	18	0.38	0.63	6.0	3.0	1.5
Minimum	30	0.50	0.75	10	5.0	1.88
Conventional	36	0.63	0.88	12	6.0	2.25
Expwy/Fwy	48	0.75	1.25	16	8.0	3.0

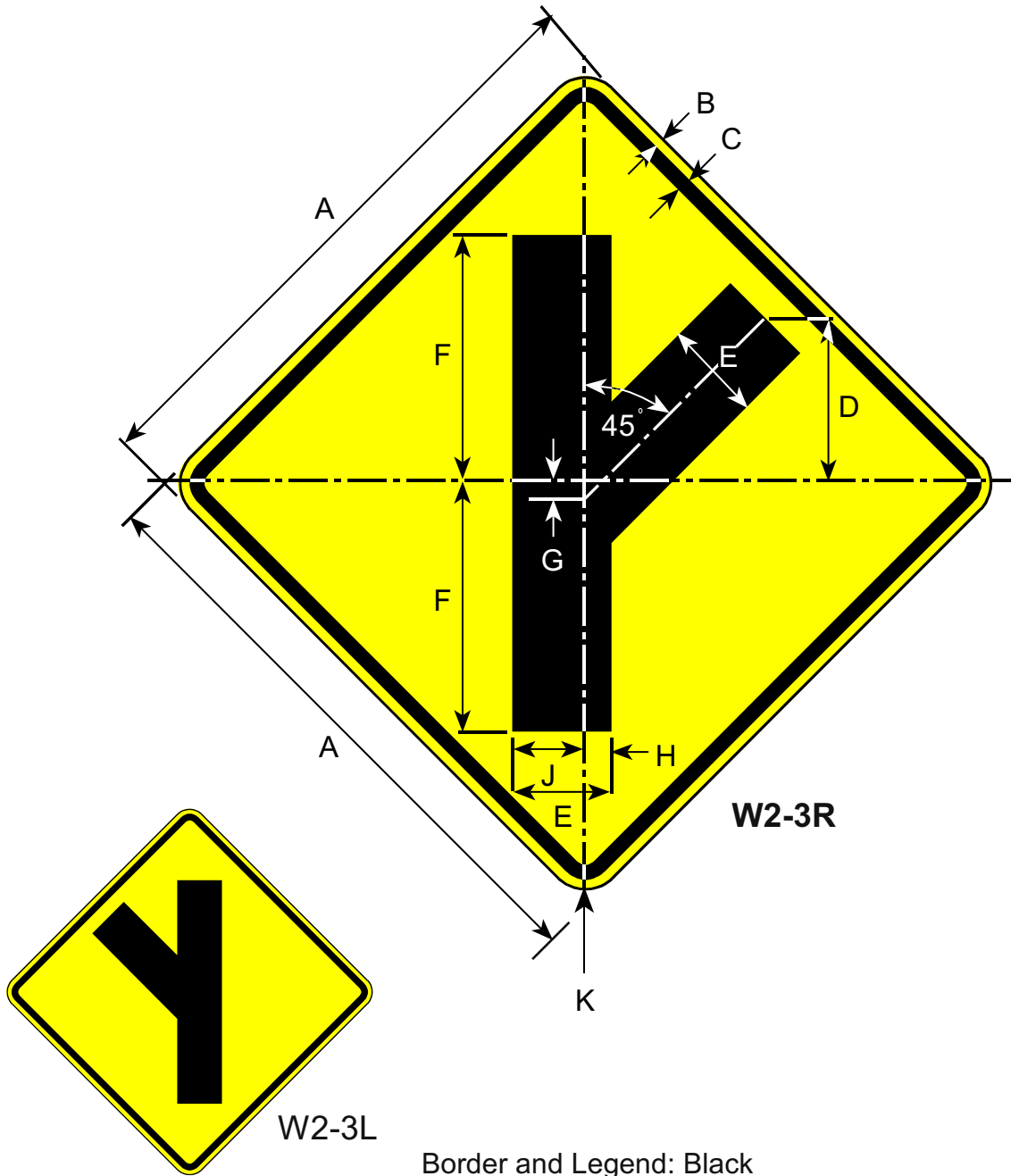

Border and Legend: Black
Background: Yellow

Road Class	Dimensions (inches)									
	A	B	C	D	E	F	G	H	J	K
Bike	18	0.38	0.63	5.0	3.0	7.75	0.38	0.75	2.25	1.5
Minimum	24	0.38	0.63	6.66	4.0	10	0.56	1.0	3.0	1.5
Conventional	30	0.50	0.75	8.31	5.0	12.5	0.66	1.25	3.75	1.88
Expwy	36	0.63	0.88	10	6.0	15	0.84	1.5	4.5	2.25
Freeway	48	0.75	1.25	13.31	7.0	20	1.13	2.0	6.0	3.0

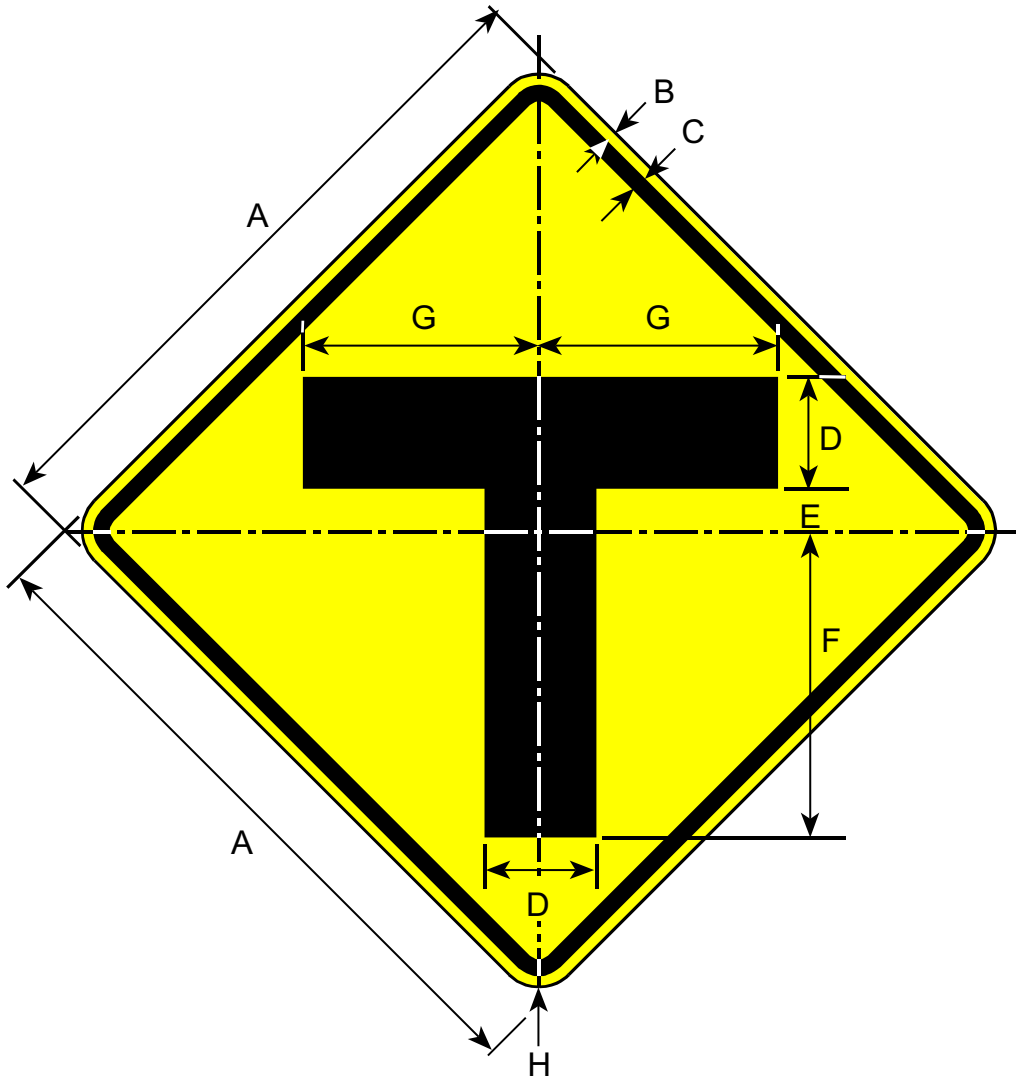

Border and Legend: Black
Background: Yellow

Road Class	Dimensions (inches)							
	A	B	C	D	E	F	G	H
Bike	18	0.38	0.63	3.0	1.25	8.38	6.38	1.5
Minimum	30	0.50	0.75	5.0	1.88	13.75	10.63	1.88
Conventional	36	0.63	0.88	6.0	2.25	16.5	12.75	2.25
Expwy/Fwy	48	0.75	1.25	8.0	3.0	22	17	3.0

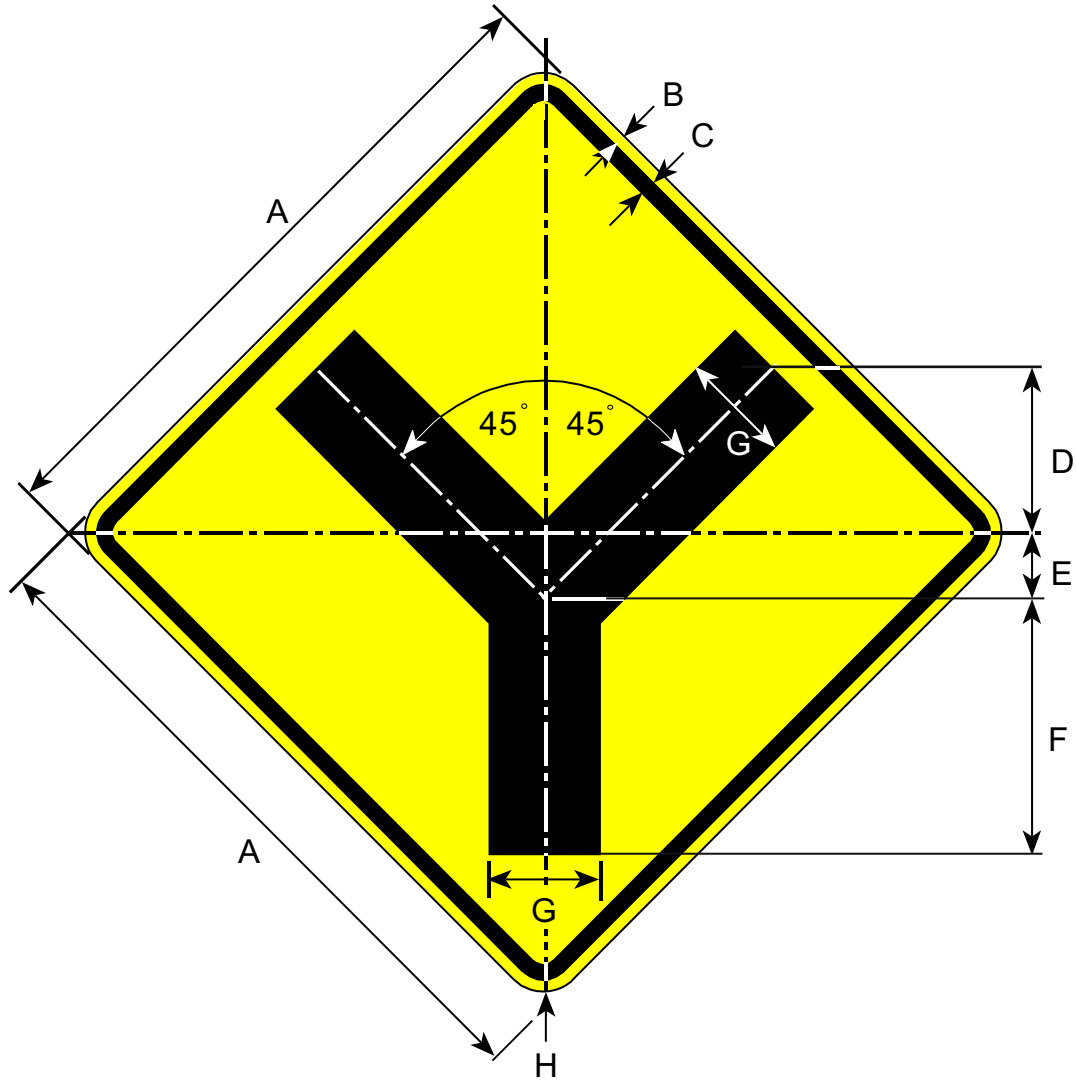

Border and Legend: Black
Background: Yellow

Road Class	Dimensions (inches)							
	A	B	C	D	E	F	G	H
Bike	18	0.38	0.63	4.50	1.75	6.66	3	1.50
Minimum	30	0.50	0.75	7.38	3.00	11.25	5	1.88
Conventional	36	0.63	0.88	8.84	3.59	13.50	6	2.25
Expwy/Fwy	48	0.75	1.25	11.66	4.75	18.00	8	3.00

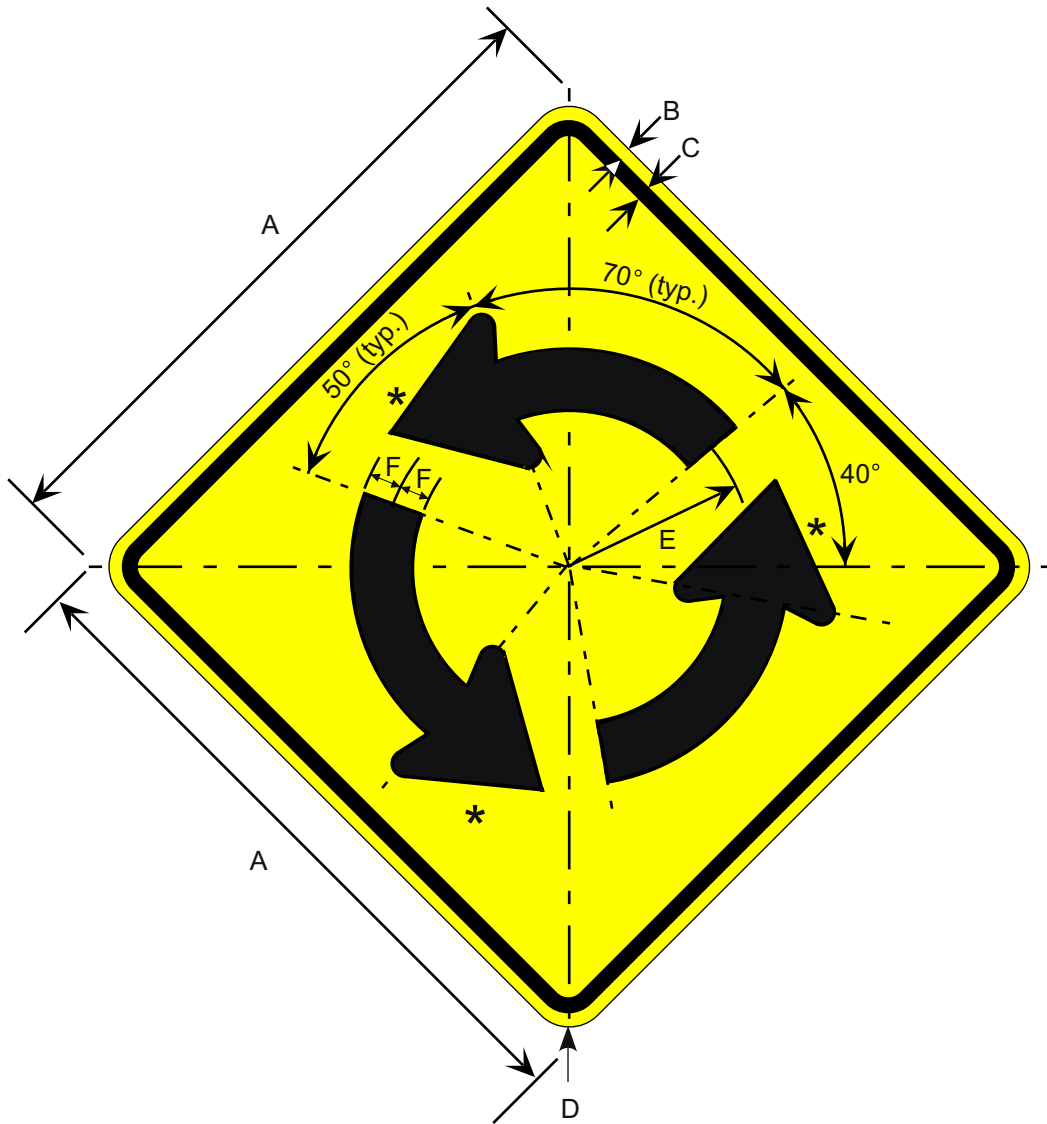

Border and Legend: Black
 Background: Yellow

Make symbol proportional
 to the one shown.

* See Appendix B-1 for Standard Arrow Details.

Road Class	Dimensions (inches)					
	A	B	C	D	E	F
Conventional	36	0.63	0.88	2.25	10	1.63
Expressway	48	0.75	1.25	3.0	13.25	2.13

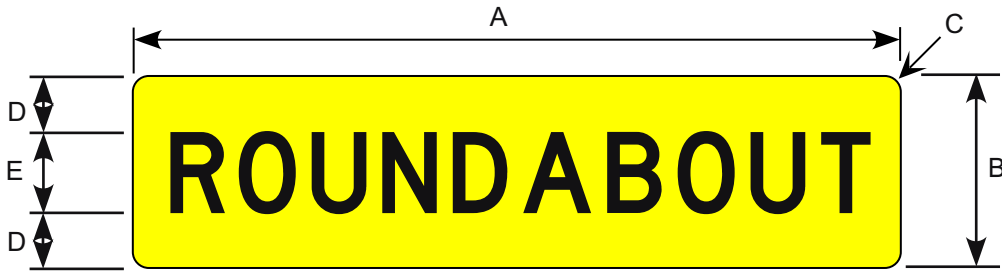

Border and Legend: Black
 Background: Yellow

Road Class	Dimensions (inches)				
	A	B	C	D	E
Conv & Min	36	12	1.5	3.5	5C
Expressway	48	12	2.0	3.0	6C

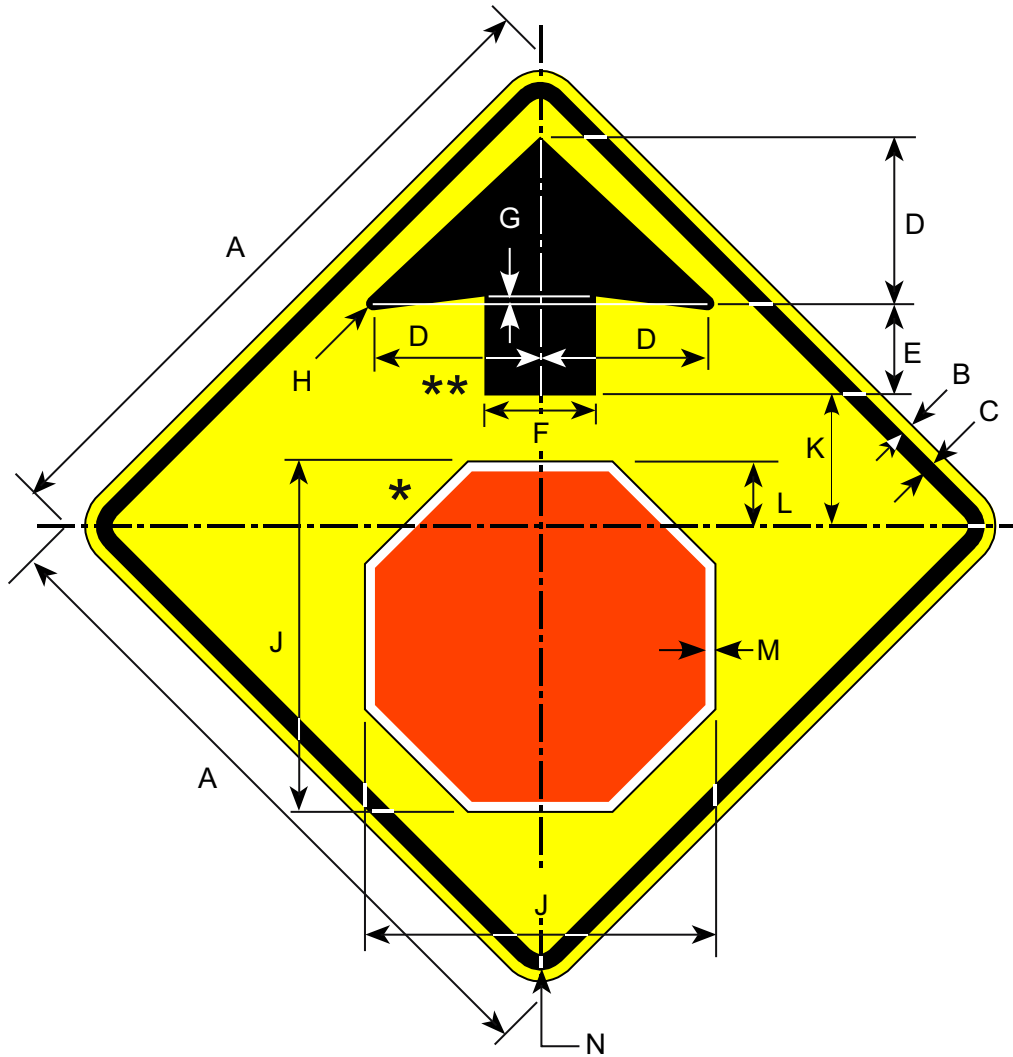

Border and Legend: Black
 Background: Yellow
 Symbol: White Border on Red Background

* Make symbol proportional to the one shown.
 ** See Appendix B-3 for Arrow Details.

Prior to the 2002 publication of this manual, this sign was numbered W3-1.

Road Class	Dimensions (inches)												
	A	B	C	D	E	F	G	H	J	K	L	M	N
Minimum	30	0.50	0.75	7.5	3.75	5.0	0.63	0.31	15.75	6.25	2.88	0.50	1.88
Conventional	36	0.63	0.88	9.0	4.5	6.0	0.75	0.38	19	7.5	3.5	0.63	2.25
Expwy/Fwy	48	0.75	1.25	12	6.0	8.0	1.0	0.50	25.13	10	4.5	0.75	3.0

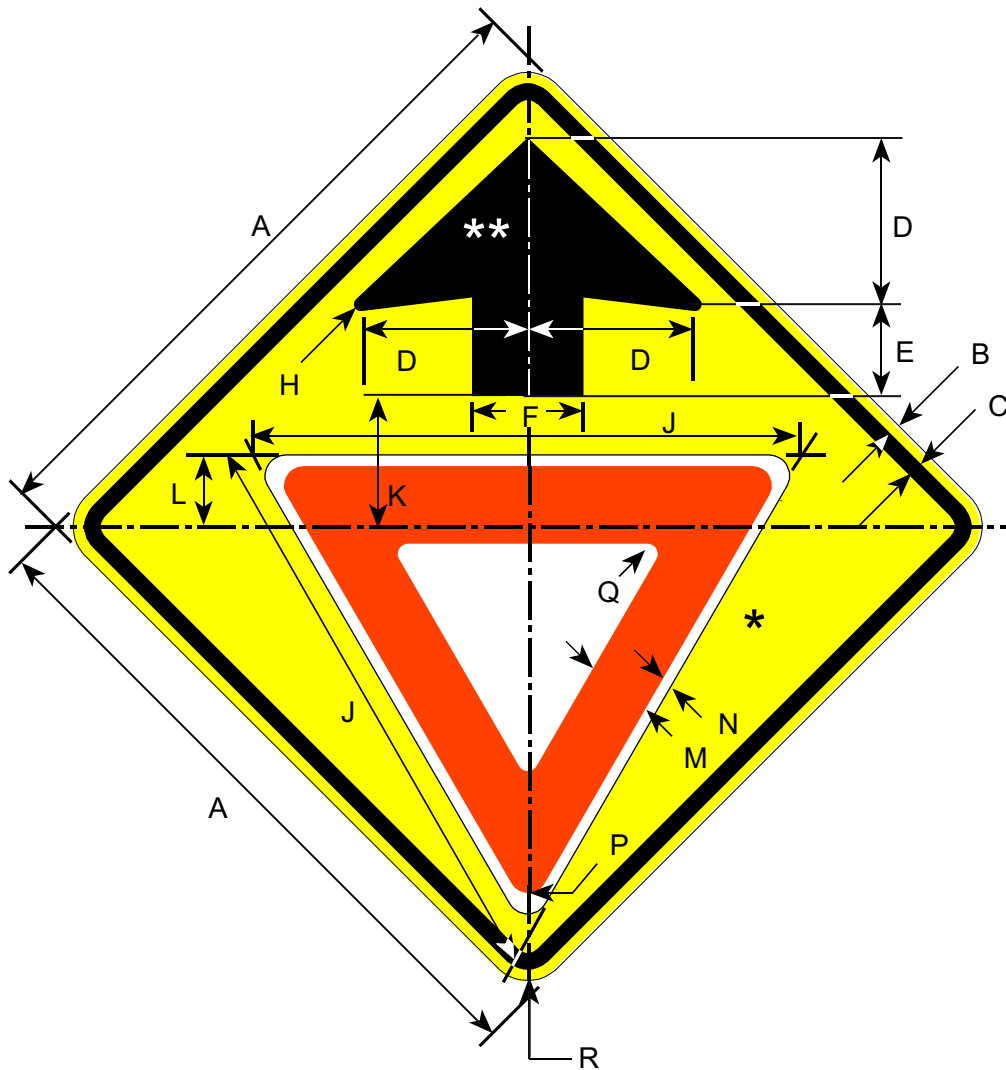

Border and Legend: Black
 Background: Yellow
 Symbol: Red Border on White Background

- * Make symbol proportional to the one shown.
- ** See Appendix B-3 for Arrow Details.

Prior to the 2002 publication of this manual, this sign was numbered W3-2.

Prior to the 2006 publication of this manual, this sign was numbered W3-2A.

Road Class	Dimensions (inches)														
	A	B	C	D	E	F	H	J	K	L	M	N	P	Q	R
Minimum	30	0.50	0.75	7.5	3.75	5.0	0.31	25	6.25	3.0	3.38	0.50	1.25	0.63	1.88
Conventional	36	0.63	0.88	9.0	4.5	6.0	0.38	28	7.5	3.38	3.75	0.63	1.38	0.75	2.25
Expwy/Fwy	48	0.75	1.25	12	6.0	8.0	0.50	38	10	4.5	5.0	0.75	1.88	1.0	3.0

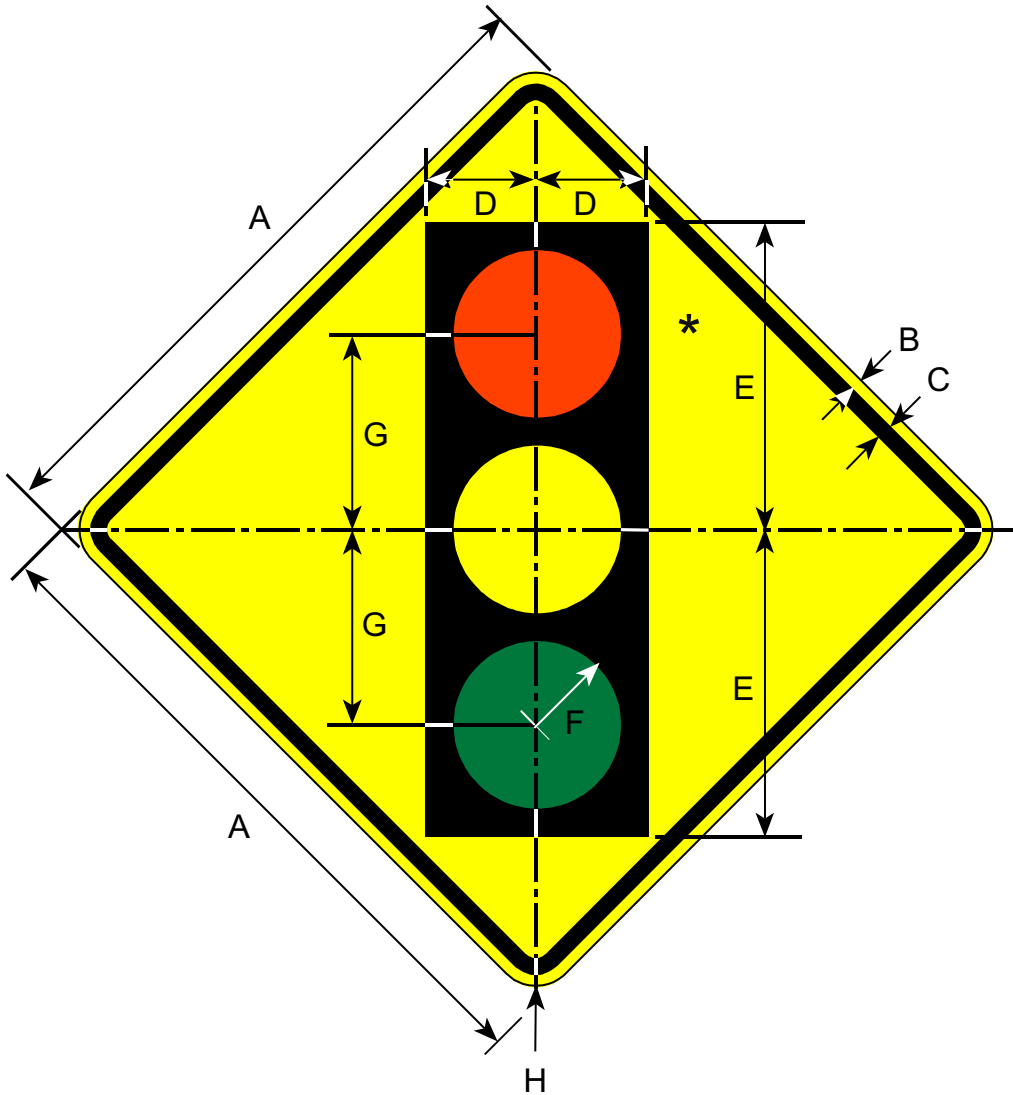

Border and Legend: Black
 Top Circle: Red
 Middle Circle: Yellow
 Bottom Circle: Green
 Background: Yellow

Road Class	Dimensions (inches)							
	A	B	C	D	E	F	G	H
Bike	18	0.38	0.63	3.00	8.00	2.25	5.00	1.50
Minimum	30	0.50	0.75	5.00	13.75	3.75	8.75	1.88
Conventiona	36	0.63	0.88	5.75	15.75	4.25	10.00	2.25
Expwy/Fwy	48	0.75	1.25	7.50	20.00	5.00	12.50	3.00

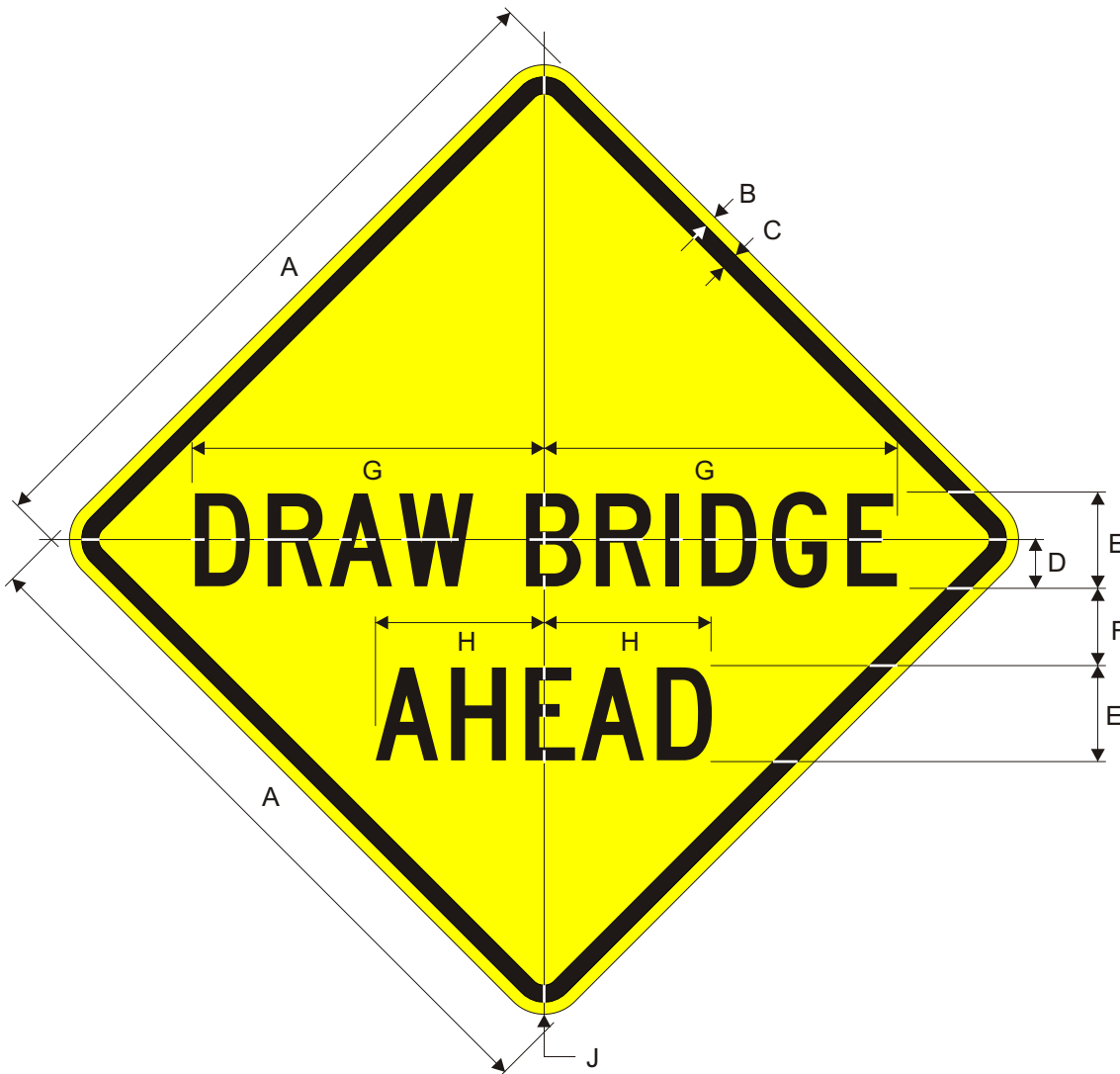

Border and Legend: Black
Background: Yellow

Road Class	Dimensions (inches)								
	A	B	C	D	E	F	G	H	J
Conventional	36	0.63	0.88	2.5	5C	4.0	18.27	8.71	2.25
Expy/Fwy	48	0.75	1.25	3.5	7C	6.0	25.58	12.20	3.0
Oversized	60	0.75	1.25	4.5	9C	8.0	32.89	15.69	3.0

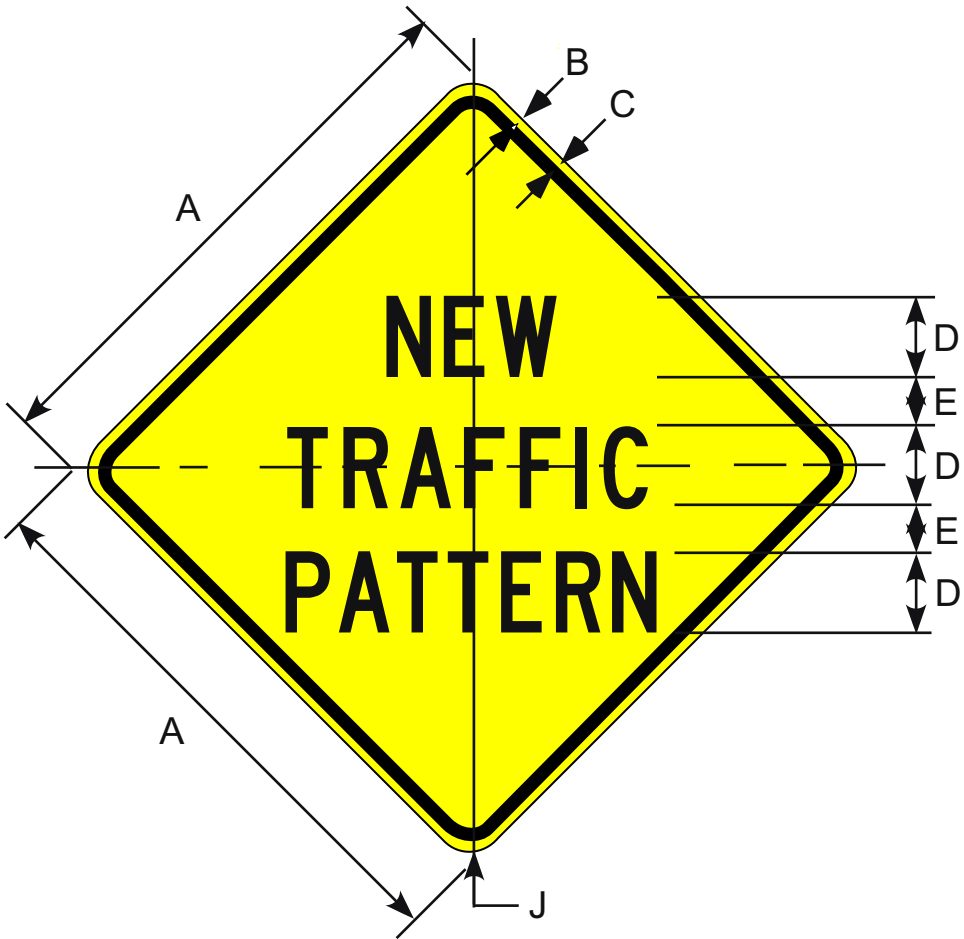

Border and Legend: Black
 Background: Yellow

Road Class	Dimensions (inches)					
	A	B	C	D	E	J
Minimum	30	0.50	0.75	4C	2.50	1.88
Conventional	36	0.63	0.88	5C	3.00	2.25
Expwy/Fwy	48	0.75	1.25	7C	4.00	3.00

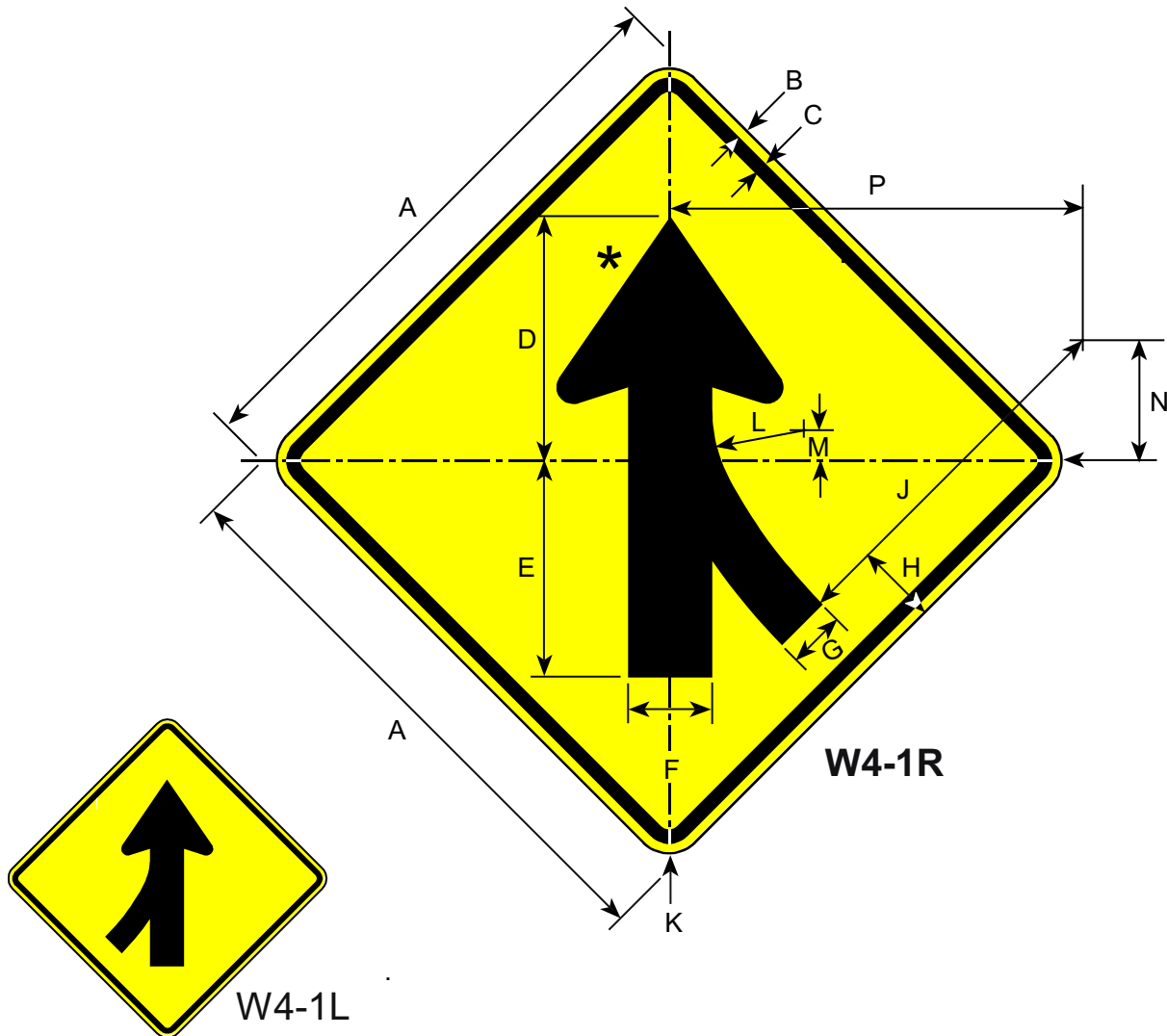

Border and Legend: Black
Background: Yellow

* See Appendix B-1 for Standard Arrow Details.

Road Class	Dimensions (inches)														
	A	B	C	D	E	F	G	H	J	K	L	M	N	P	
Bike	24	0.38	0.63	10.25	8.75	3.5	2.38	4.19	22.25	1.5	6.38	2.63	10.38	22.19	
Minimum	30	0.50	0.75	13	11	4.38	3.0	5.25	28	1.88	8.0	3.0	13	27.75	
Conventional	36	0.63	0.88	15.75	13.25	5.25	3.63	6.31	33.63	2.25	9.63	4.0	15.63	35.31	
Expwy/Fwy	48	0.75	1.25	20.5	17.5	7.0	4.75	8.38	45	3.0	12.81	5.25	20.75	44.38	

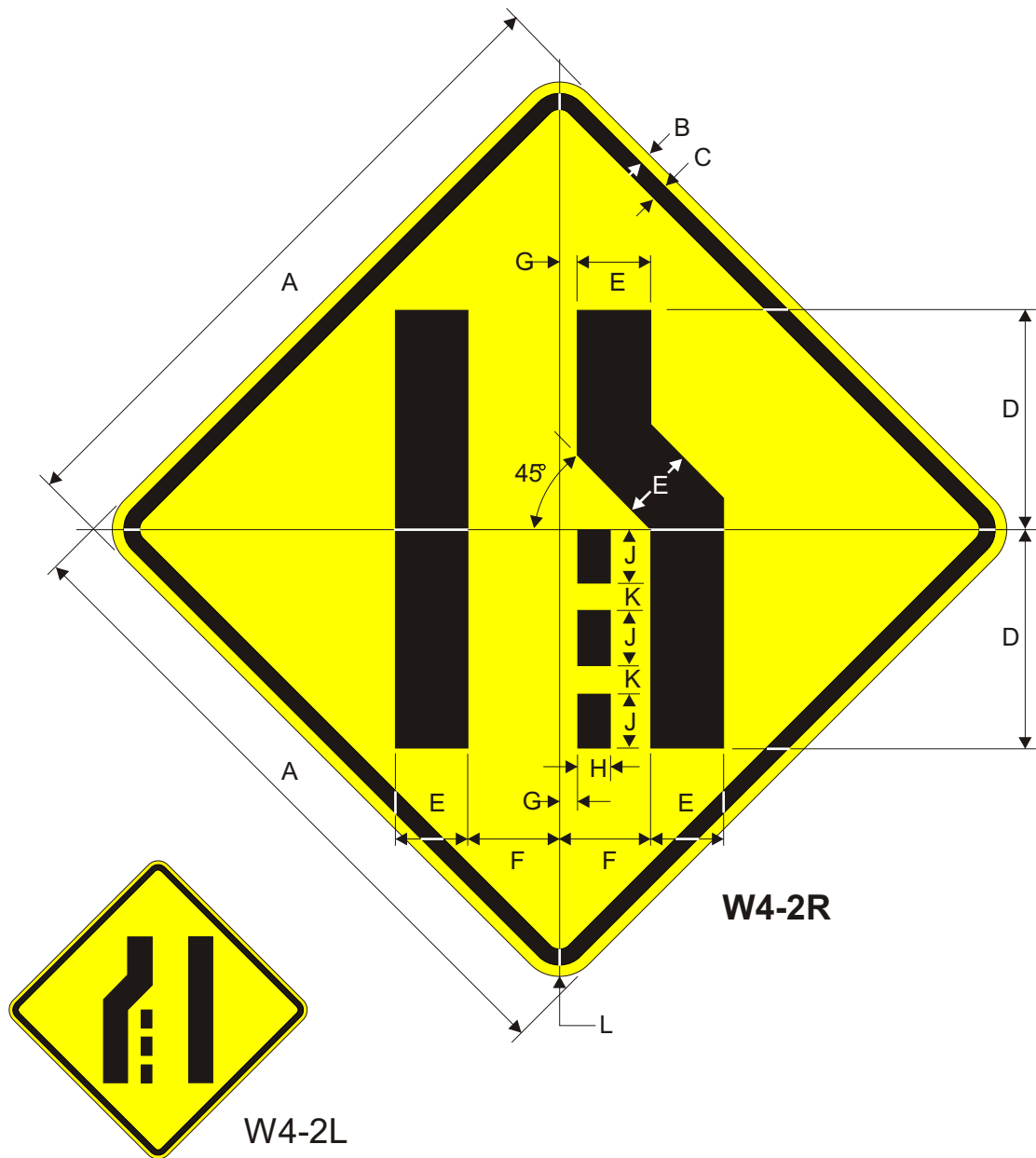

Border and Legend: Black
Background: Yellow

Road Class	Dimensions (inches)										
	A	B	C	D	E	F	G	H	J	K	L
Min.	30	0.50	0.75	10	3.38	4.19	0.88	1.5	2.5	1.25	1.88
Conv.	36	0.63	0.88	12	4.0	5.0	1.0	1.75	3.0	1.5	2.25
Expy/Fwy	48	0.75	1.25	16	5.38	6.69	1.25	2.38	4.0	2.0	3.0

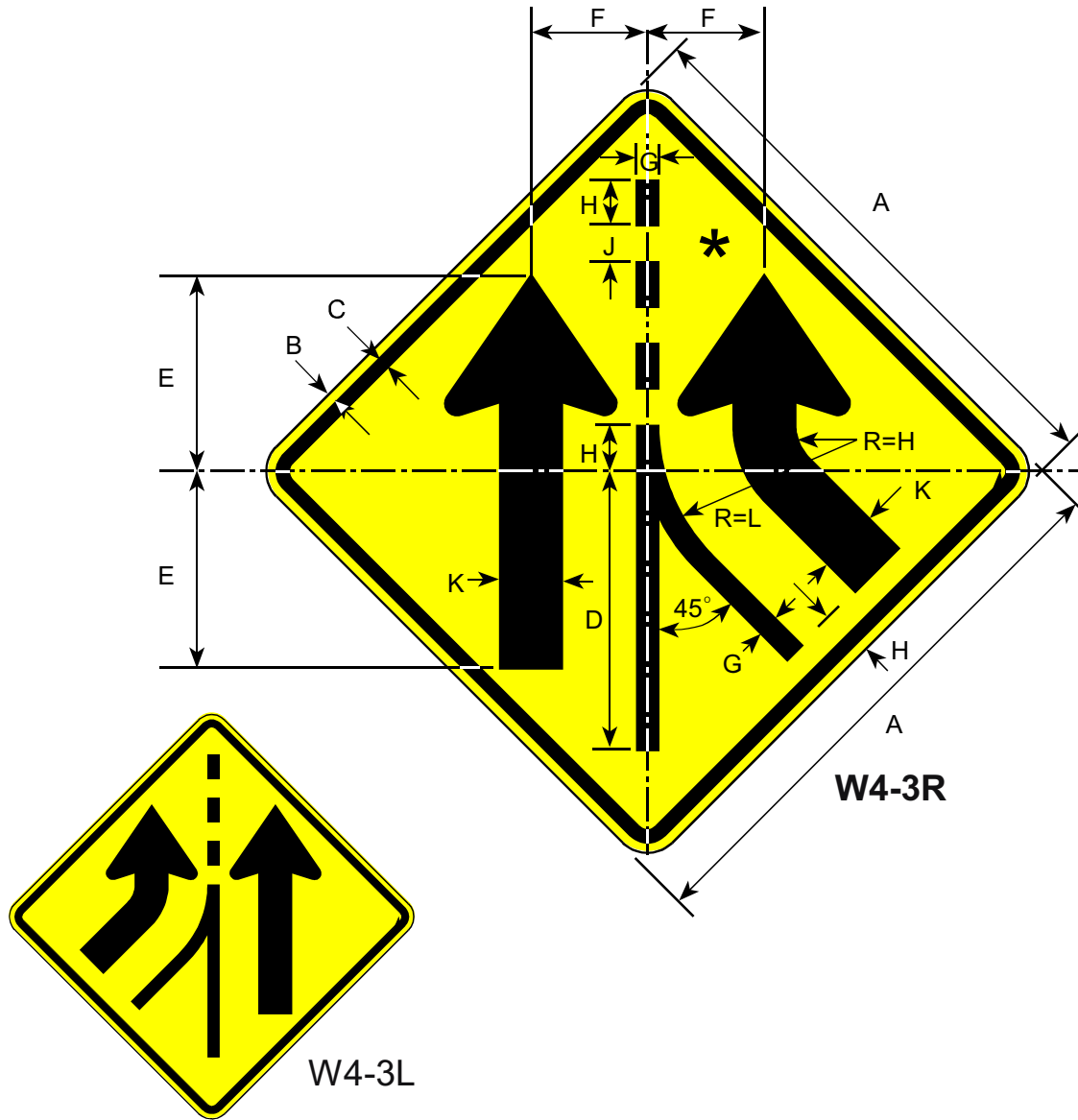

Border and Legend: Black
Background : Yellow

* See Appendix B-1 for Standard Arrow Details.

Road Class	Dimensions (inches)										
	A	B	C	D	E	F	G	H	J	K	L
Expwy/Fwy	48	0.75	1.25	24	17	10	2.0	4.0	3.0	5.5	15.75

W4-4P
W4-4A
W4-4B



W4-4P



W4-4A



W4-4B

Shall only be used with R1-1 "Stop Sign"

Border and Legend: Black
Background: Yellow

Road Class	Dimensions (inches)												
	A	B	C	D	E	F	G	H	J	K	L	M	N
Min.	24	12	0.38	0.63	3.0	2.25C	1.5	9.31	9.63	2.25B	10.11	9.78	1.5
Conv.	30	15	0.50	0.75	3.5	3C	2.0	12.42	12.42	3B	12.9	13.04	1.88
Expy.	36	18	0.63	0.88	4.0	3.5C	3.0	14.49	14.98	3.5B	15.72	15.21	2.25
Oversized	48	24	0.75	1.25	5.5	4.5C	4.0	18.63	19.26	4.5B	20.21	19.56	3.0

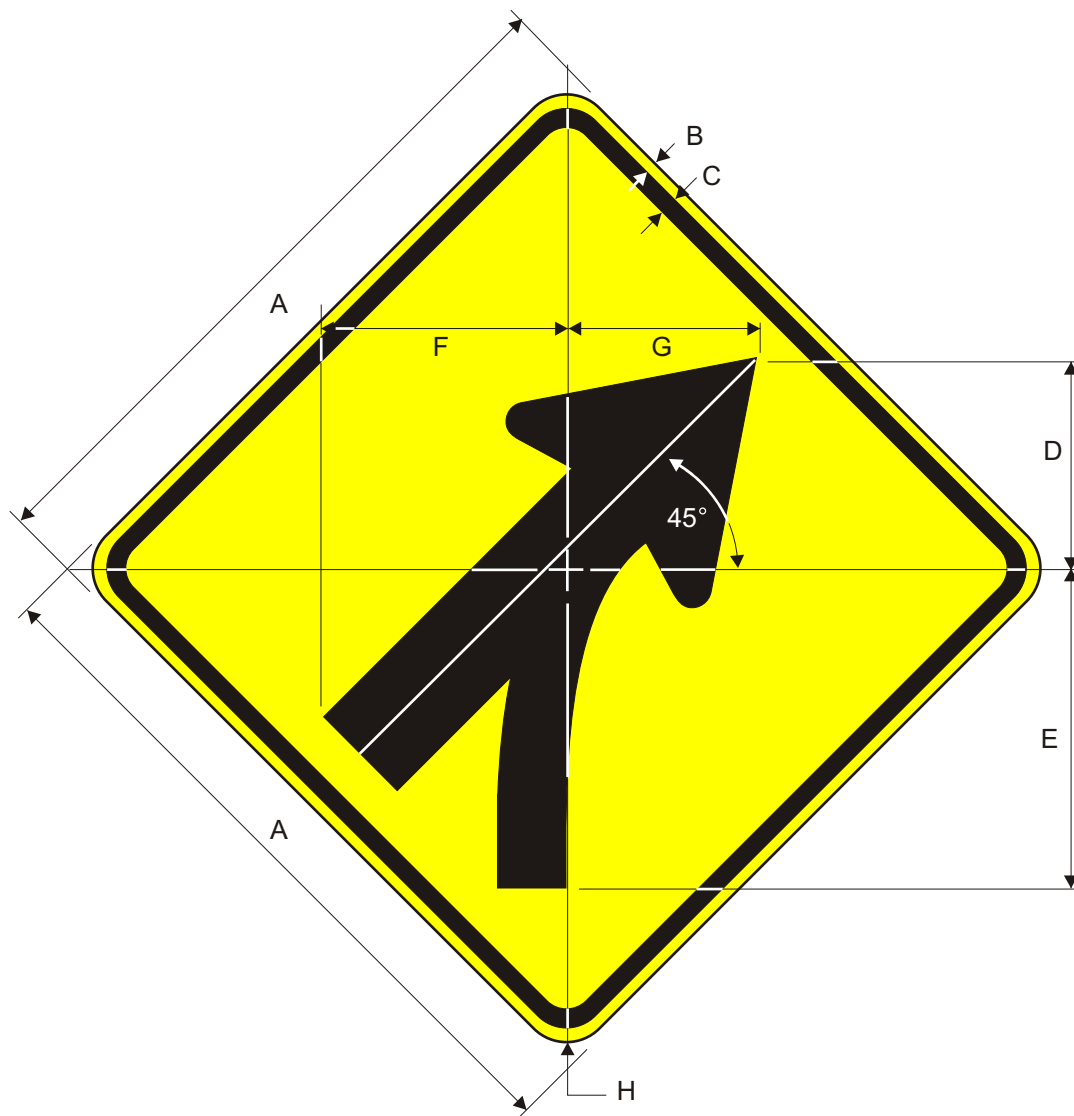

Scale and rotate W4-1 to fit dimensions.

Border and Legend: Black
Background: Yellow

Road Class	Dimensions (inches)							
	A	B	C	D	E	F	G	H
Min.	30	0.5	0.75	9.13	13.77	10.45	8.17	1.88
Conv.	36	0.63	0.88	10.93	16.53	12.57	9.81	2.25
Expy/Fwy	48	0.75	1.25	14.57	22	16.73	16.05	3.0

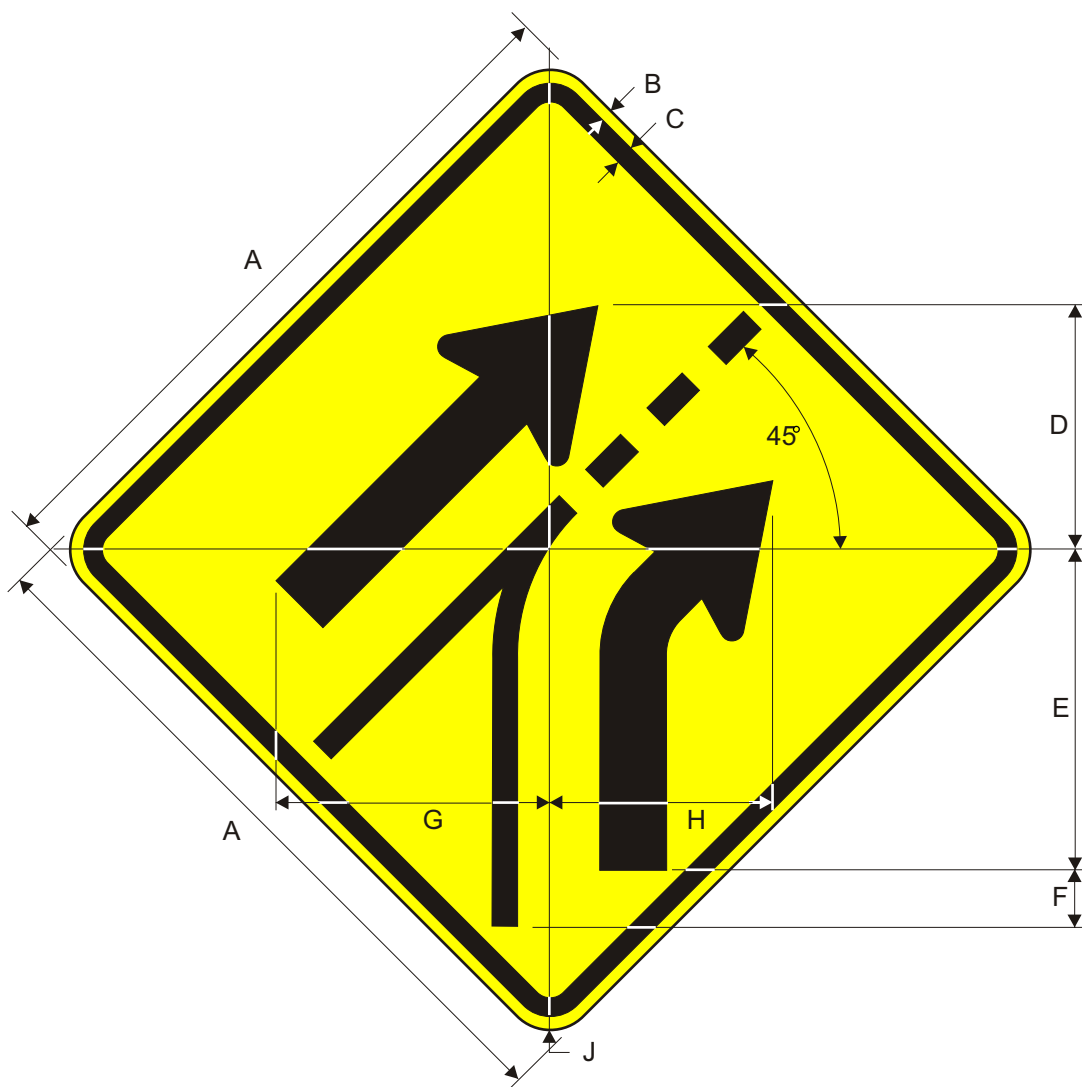

Scale and rotate W4-3 to fit dimensions.

Border and Legend: Black
Background: Yellow

Road Class	Dimensions (inches)								
	A	B	C	D	E	F	G	H	J
Min.	30	0.5	0.75	12.97	13.41	15.69	14.57	11.21	1.88
Conv.	36	0.63	0.88	15.57	16.09	18.81	17.49	13.45	2.25
Expy/Fwy	48	0.75	1.25	20.74	21.46	25.14	23.30	17.93	3.0

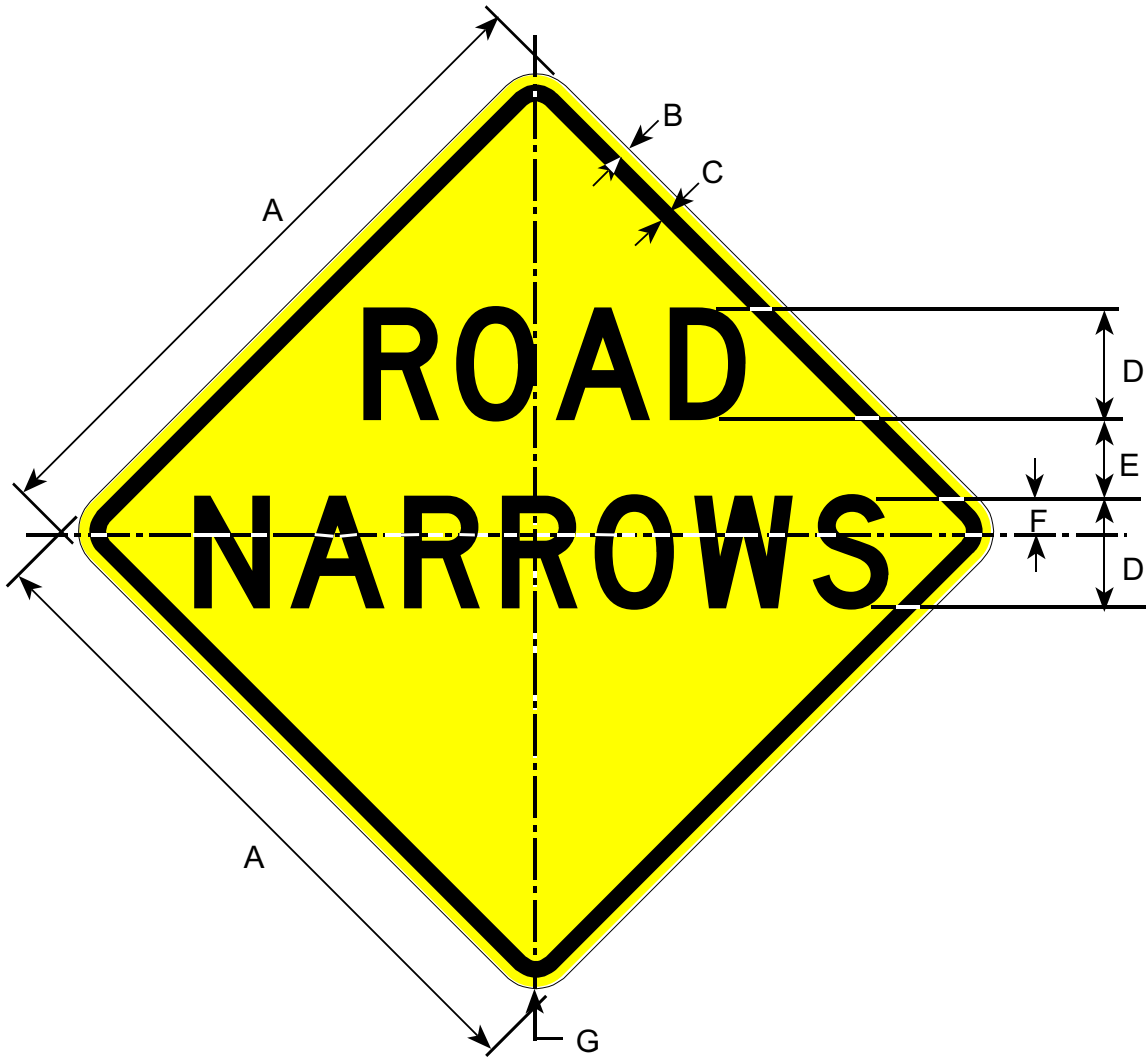

Border and Legend: Black
Background: Yellow

Road Class	Dimensions (inches)						
	A	B	C	D	E	F	G
Minimum	30	0.50	0.75	5D	3.0	1.75	1.88
Conventional	36	0.63	0.88	6D	3.5	2.00	2.25
Expwy/Fwy	48	0.75	1.25	8D	4.0	3.00	3.00

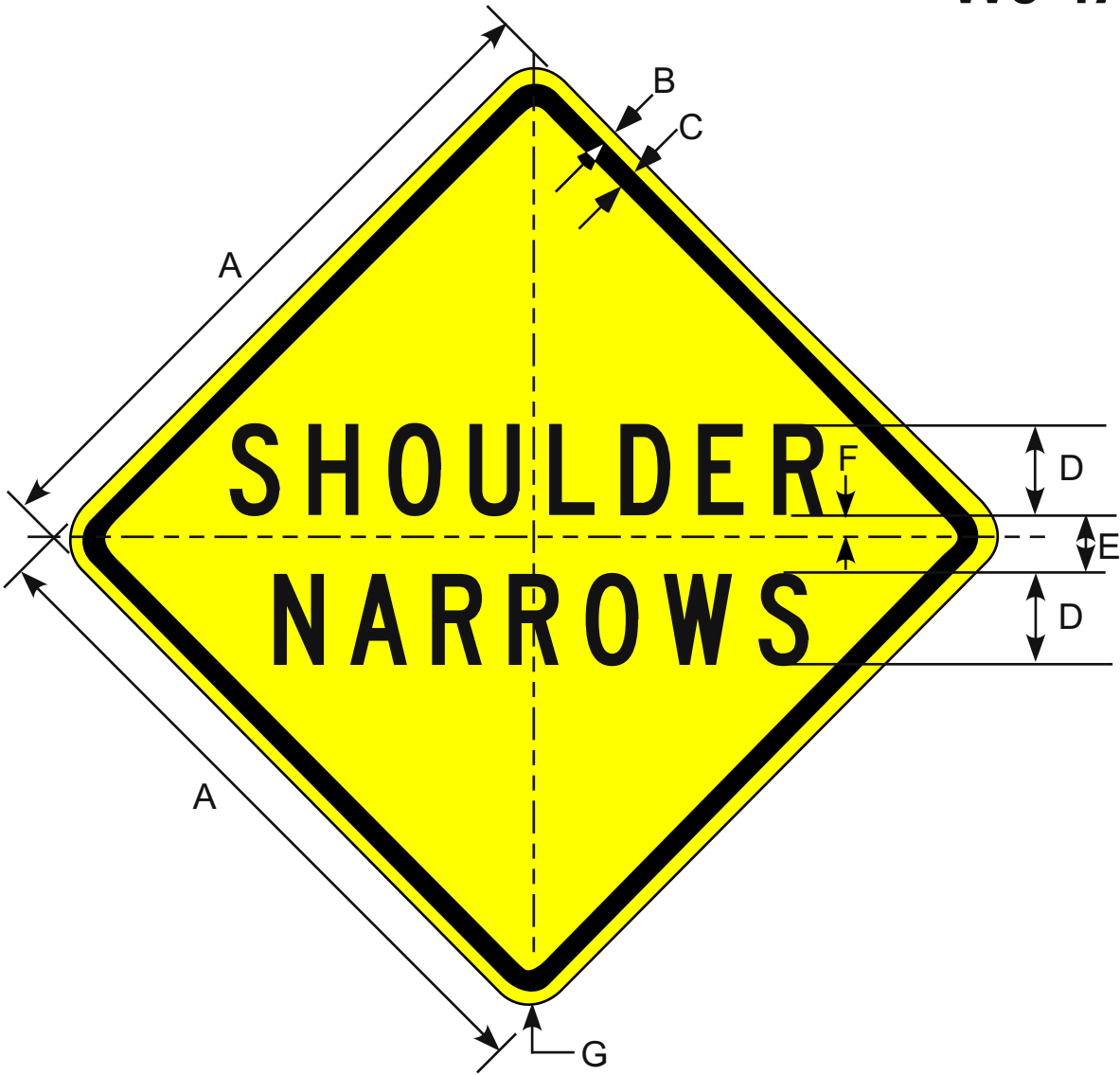

Border and Legend: Black
Background: Yellow

Road Class	Dimensions (inches)						
	A	B	C	D	E	F	G
Minimum	30	0.50	0.75	4C	3.0	1	1.88
Conventional	36	0.63	0.88	5C	3.5	1	2.25
Expwy/Fwy	48	0.75	1.25	7C	4.5	2	3.00

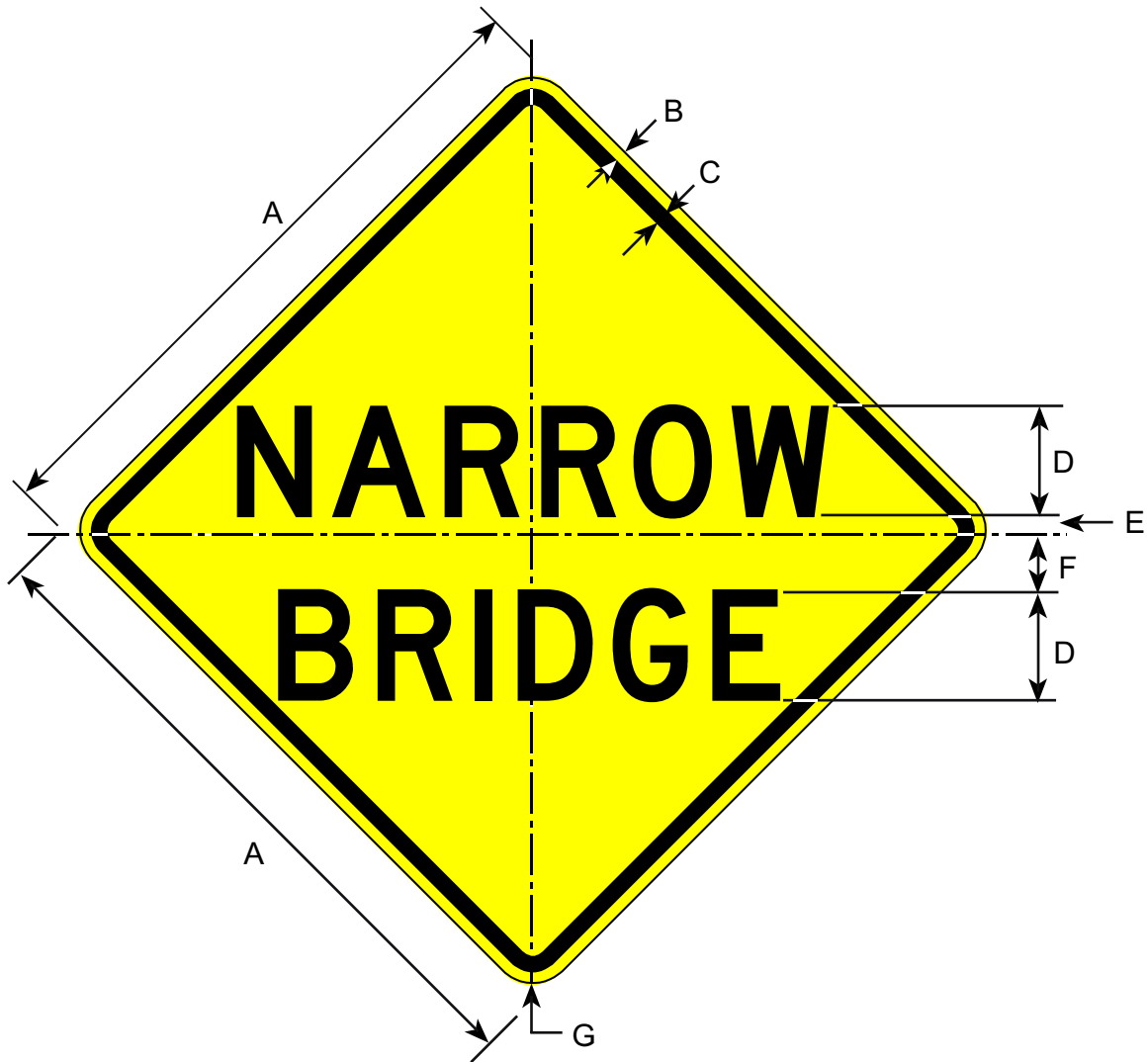

Border and Legend: Black
Background: Yellow

Road Class	Dimensions (inches)						
	A	B	C	D	E	F	G
Minimum	30	0.50	0.75	5D	0.50	2.5	1.88
Conventional	36	0.63	0.88	6D	0.75	3.0	2.25
Expwy/Fwy	48	0.75	1.25	8D	1.25	4.0	3.00

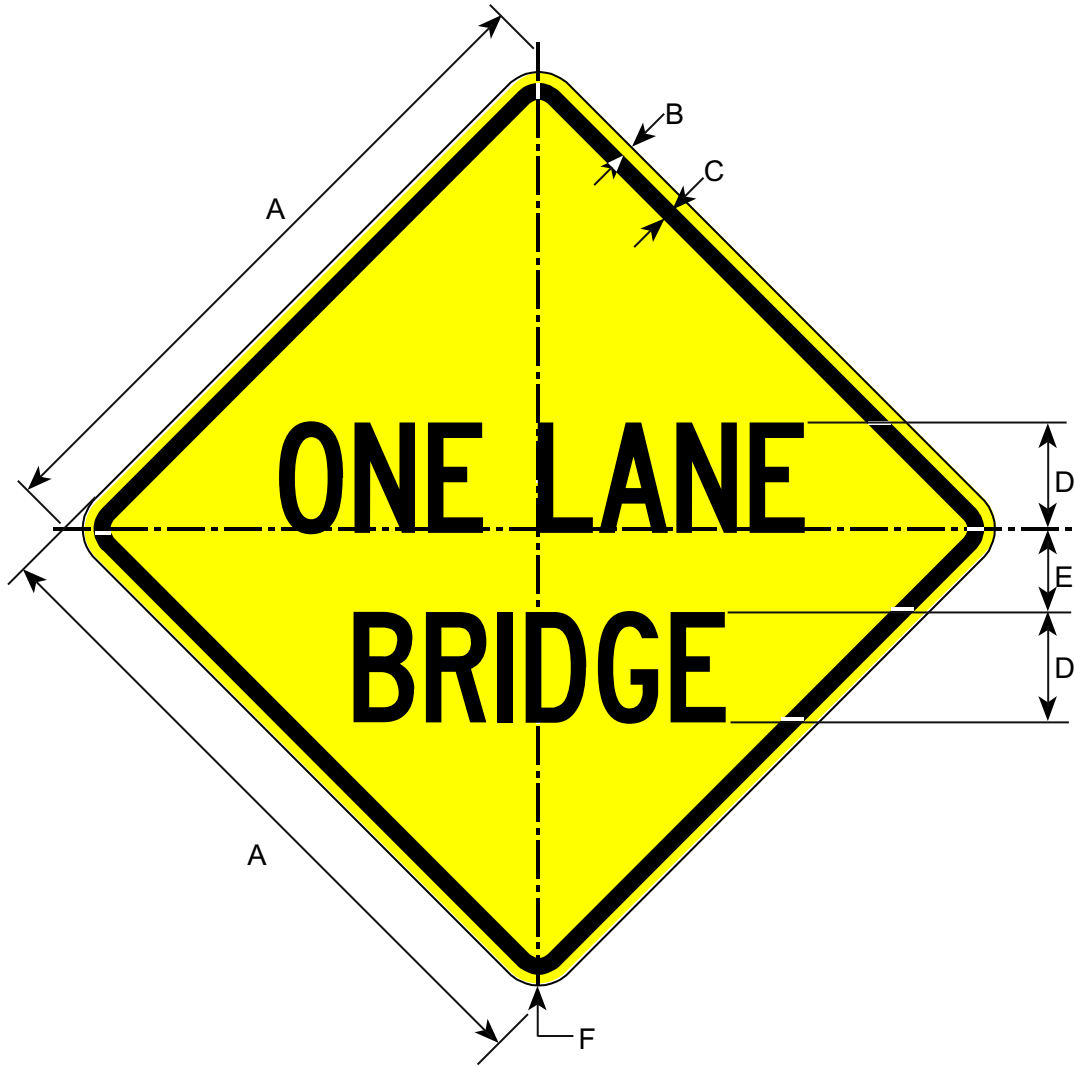

Border and Legend: Black
Background: Yellow

Road Class	Dimensions (inches)					
	A	B	C	D	E	F
Minimum	30	0.50	0.75	5C	3.25	1.88
Conventional	36	0.63	0.88	6C	4.00	2.25
Expwy/Fwy	48	0.75	1.25	8C	5.00	3.00

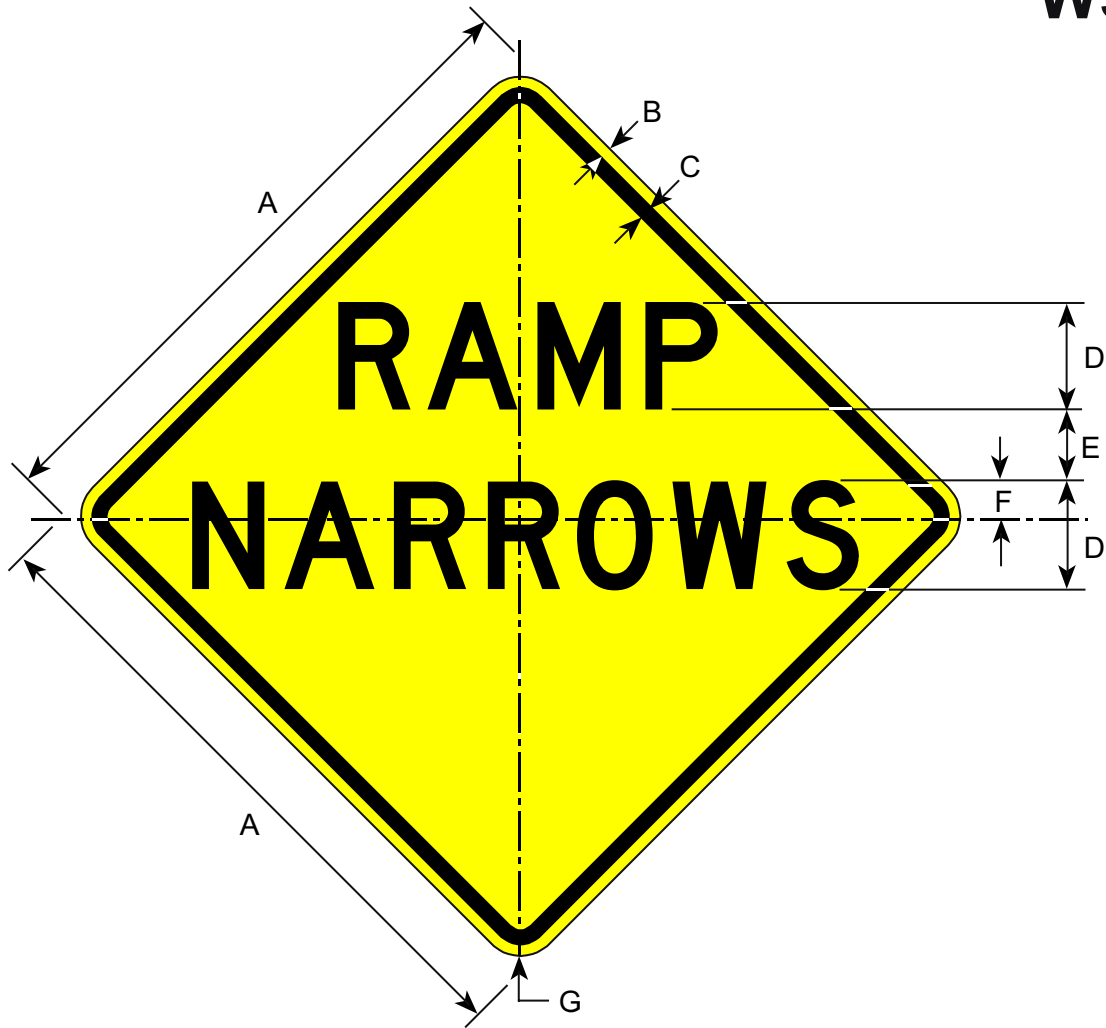

Border and Legend: Black
Background: Yellow

Road Class	Dimensions (inches)						
	A	B	C	D	E	F	G
Minimum	30	0.50	0.75	5D	3.0	1.75	1.88
Conventional	36	0.63	0.88	6D	3.5	2.00	2.50
Expwy/Fwy	48	0.75	1.50	8D	4.0	3.00	3.00



Border and Legend: Black
Background: Yellow

Road Class	Dimensions (inches)								
	A	B	C	D	E	F	G	H	J
Shared Use Path	18	0.38	0.63	0.63	3C	1.0	6.85	7.53	1.5
Roadway	30	0.5	0.75	1.0	5C	1.81	11.41	12.55	1.88

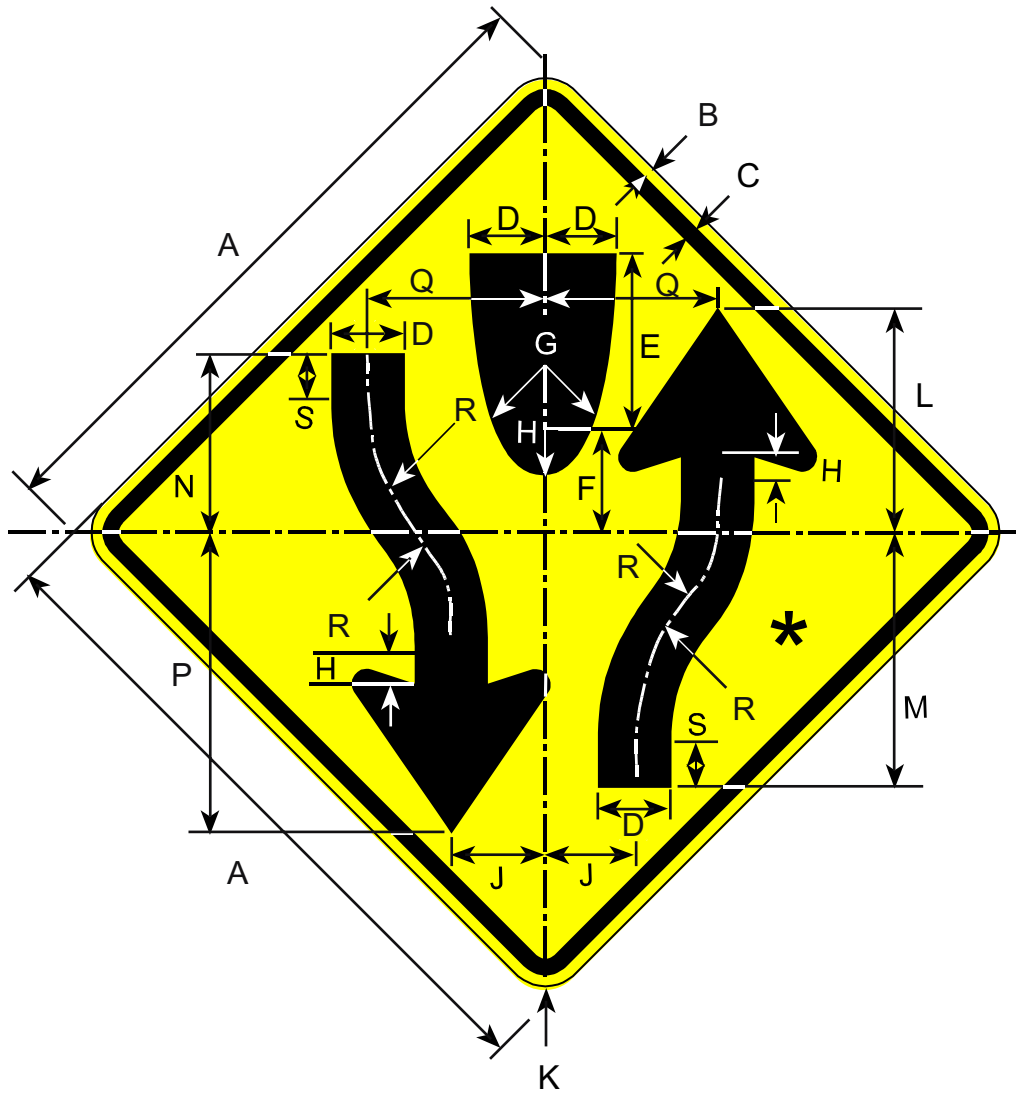

Border and Legend: Black
Background: Yellow

* See Appendix B-1 for Standard Arrow Details.

Road Class	Dimensions (inches)										
	A	B	C	D	E	F	G	H	J	K	L
Minimum	30	0.50	0.75	3.31	8.31	4.13	25	1.69	4.13	1.88	10
Conventional	36	0.63	0.88	4.0	10	5.0	30	2.0	5.0	2.25	12
Expwy/Fwy	48	0.75	1.25	5.25	13.13	6.56	39.31	2.63	6.56	3.0	16

M	N	P	Q	R	S
11.63	7.94	13.69	7.88	8.31	2.06
14	9.5	16.5	9.5	10	2.5
18.69	12.69	22	12.44	13.13	3.31

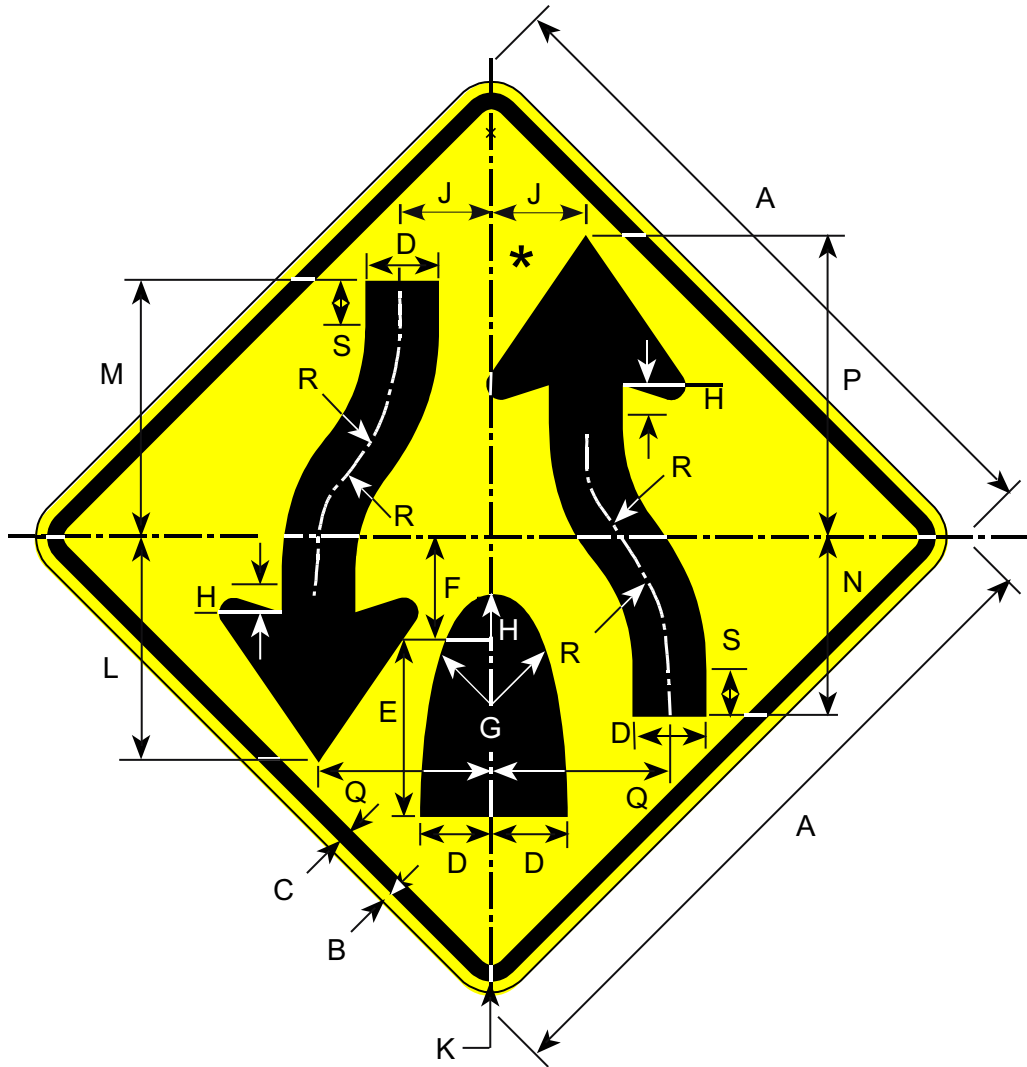

Border and Legend: Black
Background: Yellow

* See Appendix B-1 for Standard Arrow Details.

Road Class	Dimensions (inches)										
	A	B	C	D	E	F	G	H	J	K	L
Minimum	30	0.5	0.75	3.31	8.31	4.13	25	1.0	4.13	1.88	10
Conventional	36	0.63	0.88	4.0	10	5.0	30	2.0	5.0	2.25	12
Expwy/Fwy	48	0.75	1.25	5.25	13.13	6.56	39.31	2.63	6.56	3.0	16
	M	N	P	Q	R	S					
	11.63	7.94	13	7.88	8.31	2.06					
	14	9.5	16.5	9.5	10	2.5					
	18.69	12.69	22	12.44	13.13	3.31					

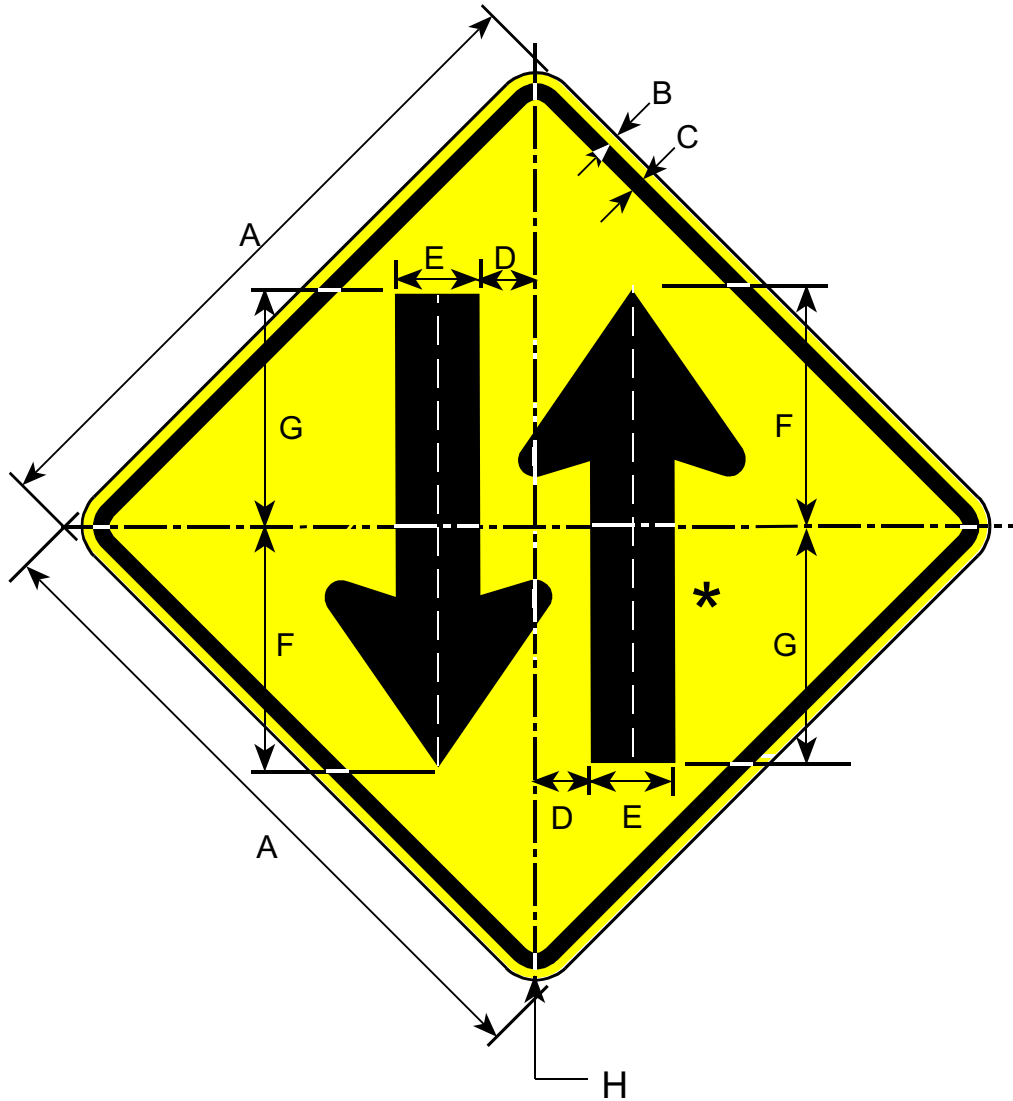

Border and Legend: Black
Background: Yellow

* See Appendix B-1 for Standard Arrow Details.

Road Class	Dimensions (inches)							
	A	B	C	D	E	F	G	H
Minimum	30	0.50	0.75	2.44	3.75	11	10.63	1.88
Conventional	36	0.63	0.88	2.94	4.5	13.5	12.75	2.25
Expwy/Fwy	48	0.75	1.5	3.88	6.0	18	17	3.0

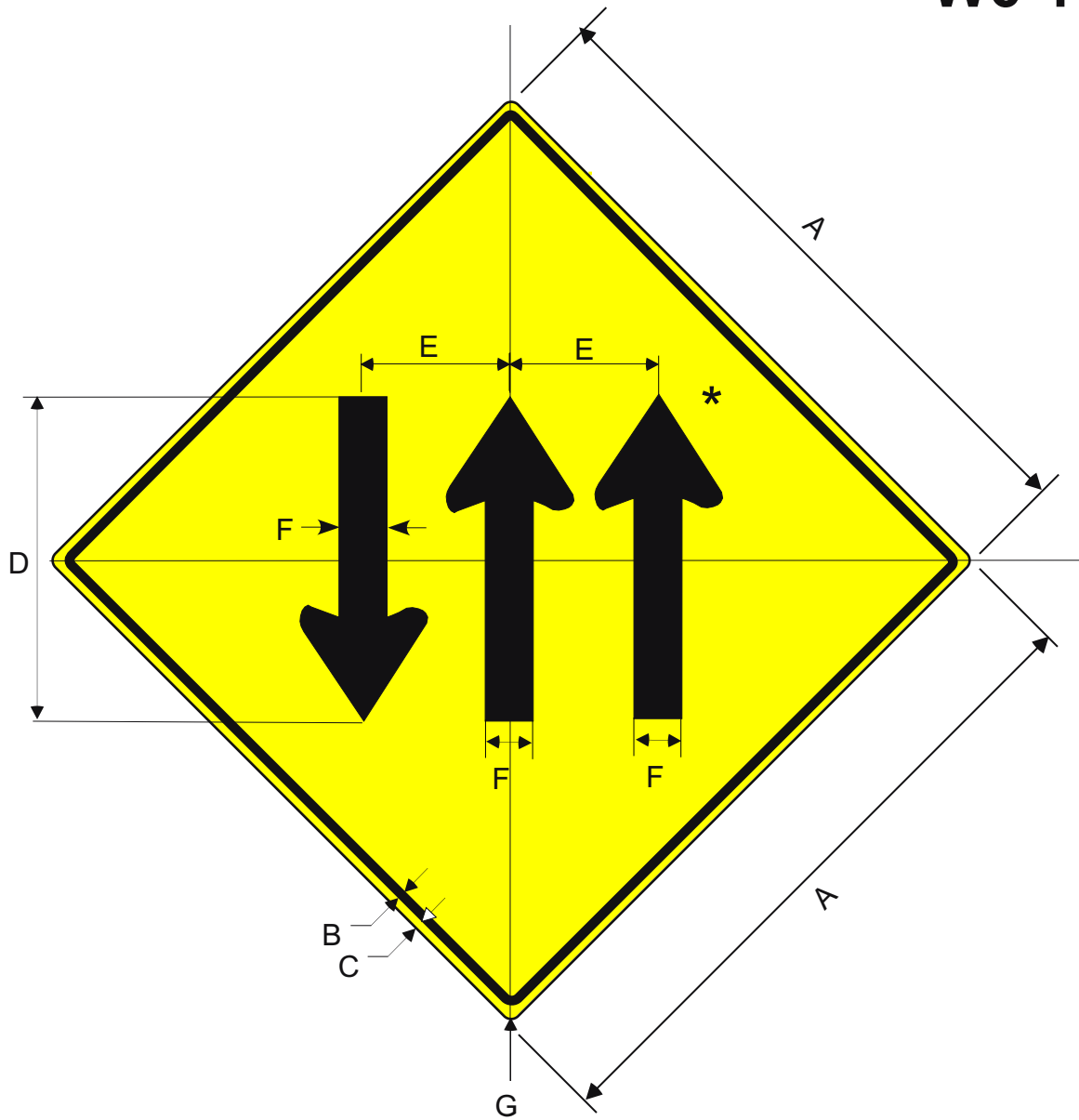

Border and Legend: Black
Background: Yellow

* See Appendix B-1 for Standard Arrow Details.

Prior to the 2002 publication of this manual, this sign was numbered W6-4(1-2).

Road Class	Dimensions (inches)						
	A	B	C	D	E	F	G
Conventional	36	0.63	0.88	22	8.0	2.75	2.25
Expwy/Fwy	48	0.75	1.25	30	11	3.5	3.0

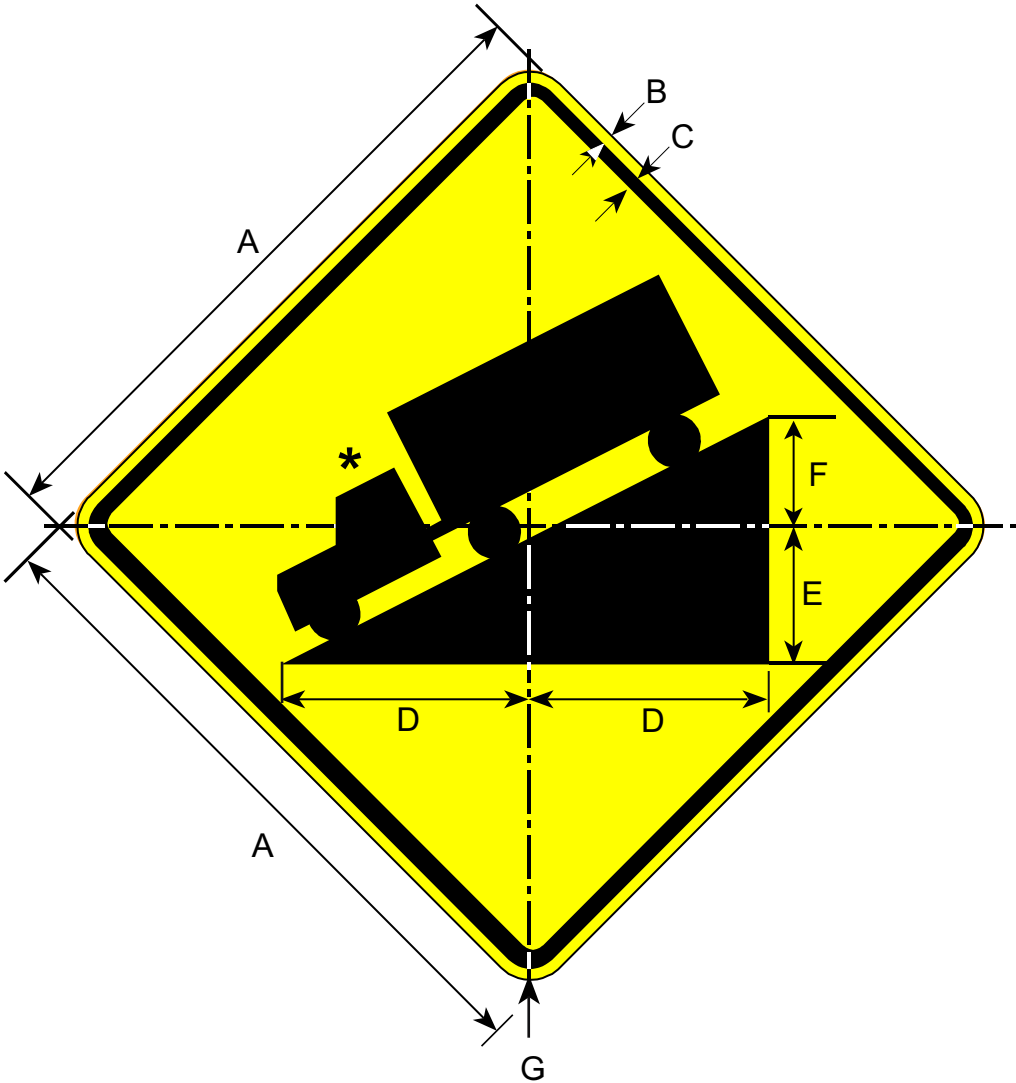

*Make symbol proportional to the graphic shown.

Border and Legend: Black
Background: Yellow

Road Class	Dimensions (inches)						
	A	B	C	D	E	F	G
Minimum	30	0.50	0.75	11	7.50	6.55	1.88
Conventional	36	0.63	0.88	13.25	9.0	7.85	2.25
Expwy/Fwy	48	0.75	1.25	17.5	12	10.48	3.0

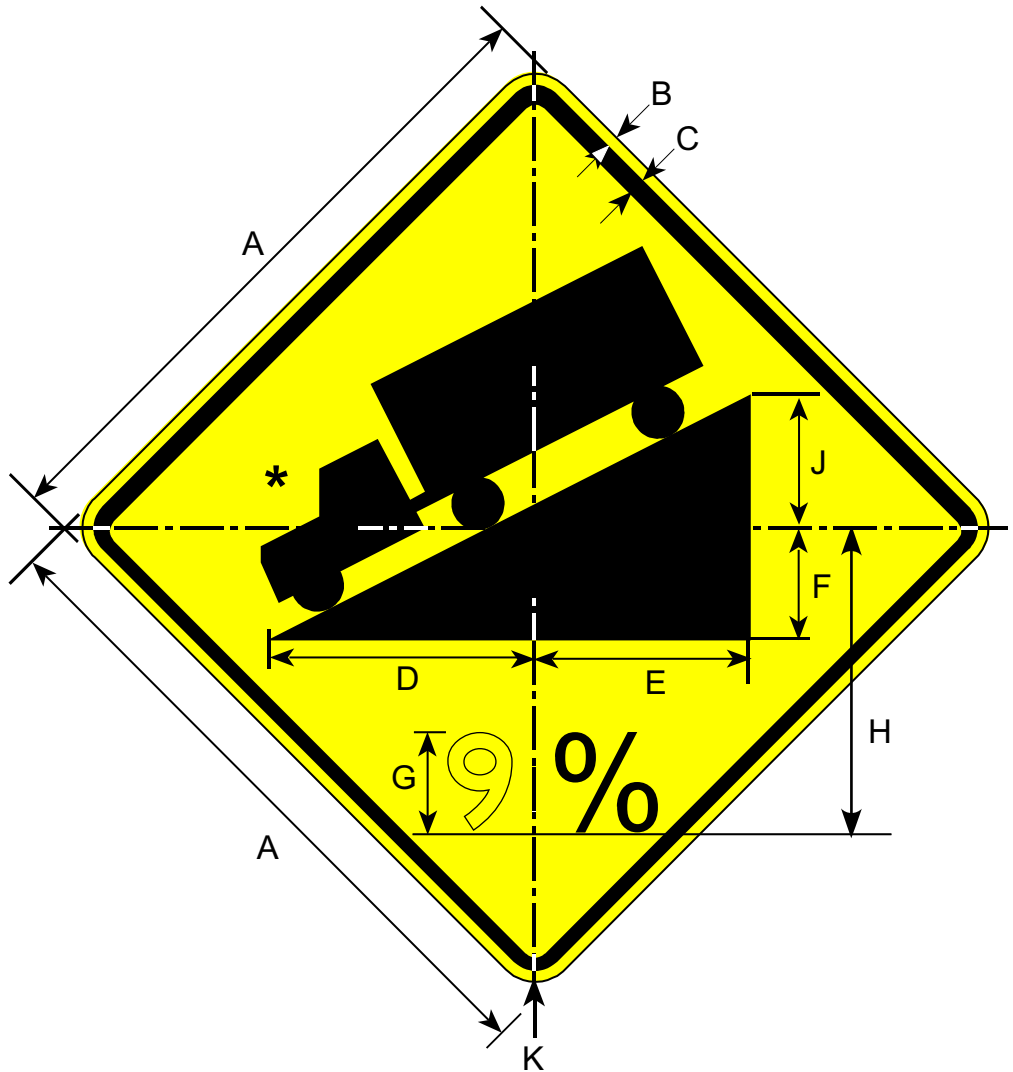

*Make symbol proportional to the graphic shown.

Border and Legend: Black
Background: Yellow

Road Class	Dimensions (inches)									
	A	B	C	D	E	F	G	H	J	K
Minimum	30	0.50	0.75	12.75	9.25	5.0	5D	12.5	6.0	1.88
Conventional	36	0.63	0.88	15.38	11.13	6.0	6D	15	7.0	2.25
Expwy/Fwy	48	0.75	1.25	20.5	14.5	8.0	8D	20	9.0	3.0

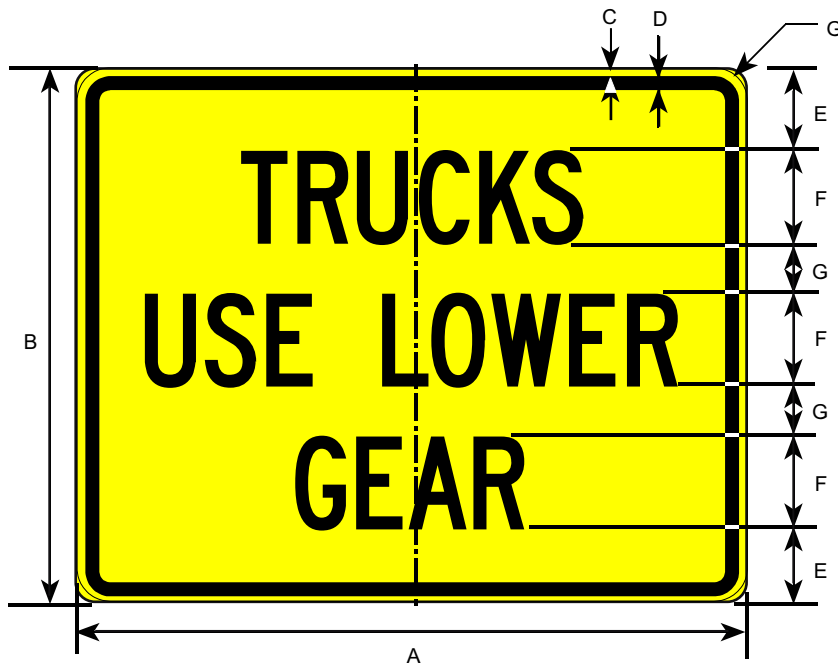

Border and Legend: Black
 Background: Yellow

Prior to the 2002 publication of this manual, this sign was numbered W7-2.

Road Class	Dimensions (inches)						
	A	B	C	D	E	F	G
Min. & Conv.	24	18	0.38	0.63	3	3C	1.5

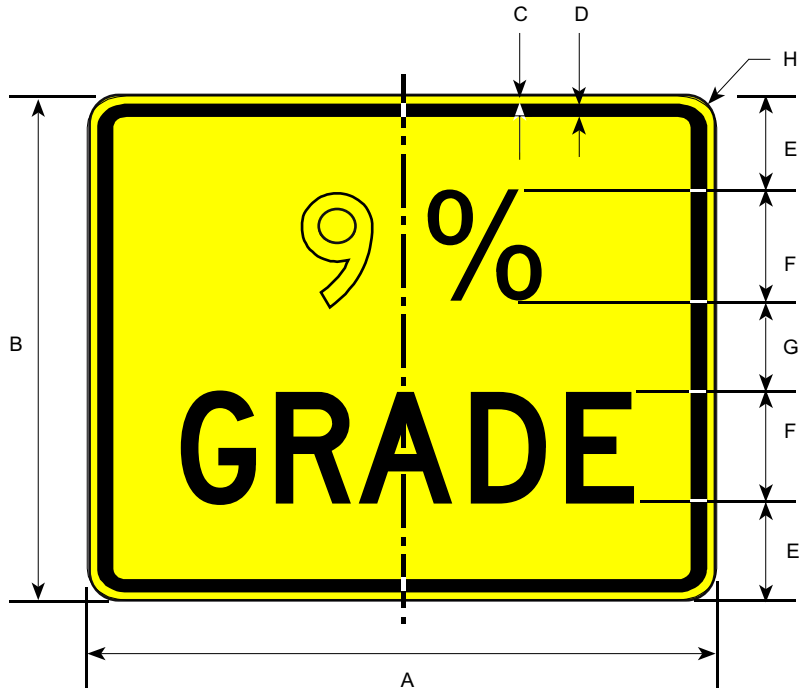

Border and Legend: Black
Background: Yellow

Road Class	Dimensions (inches)							
	A	B	C	D	E	F	G	H
Min. & Conv.	24	18	0.38	0.63	4	4D	2	1.5

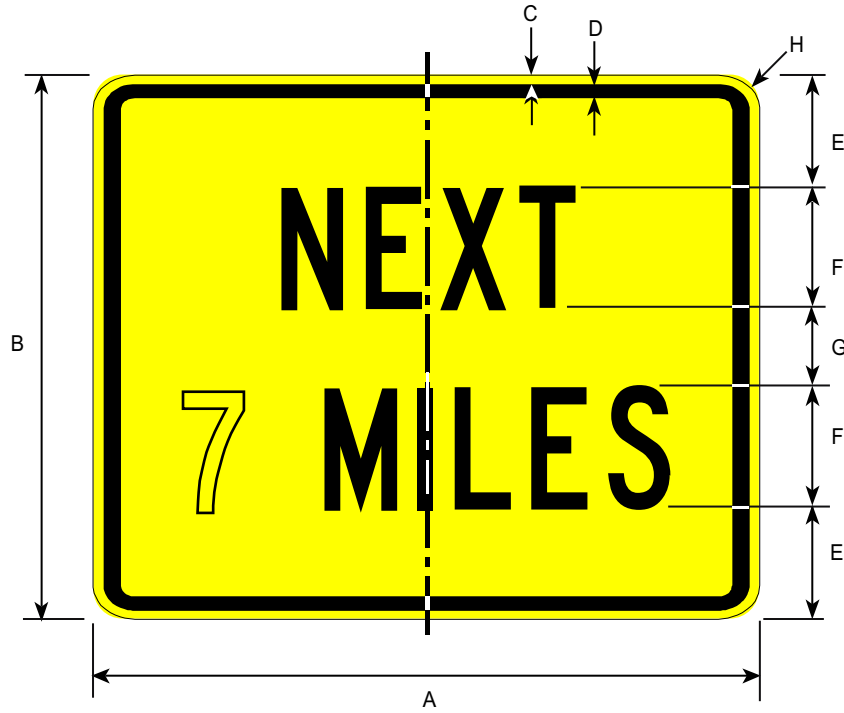

Border and Legend: Black
Background: Yellow

Road Class	Dimensions (inches)							
	A	B	C	D	E	F	G	H
Conv & Min	24	18	0.38	0.63	4	4C	2	1.5

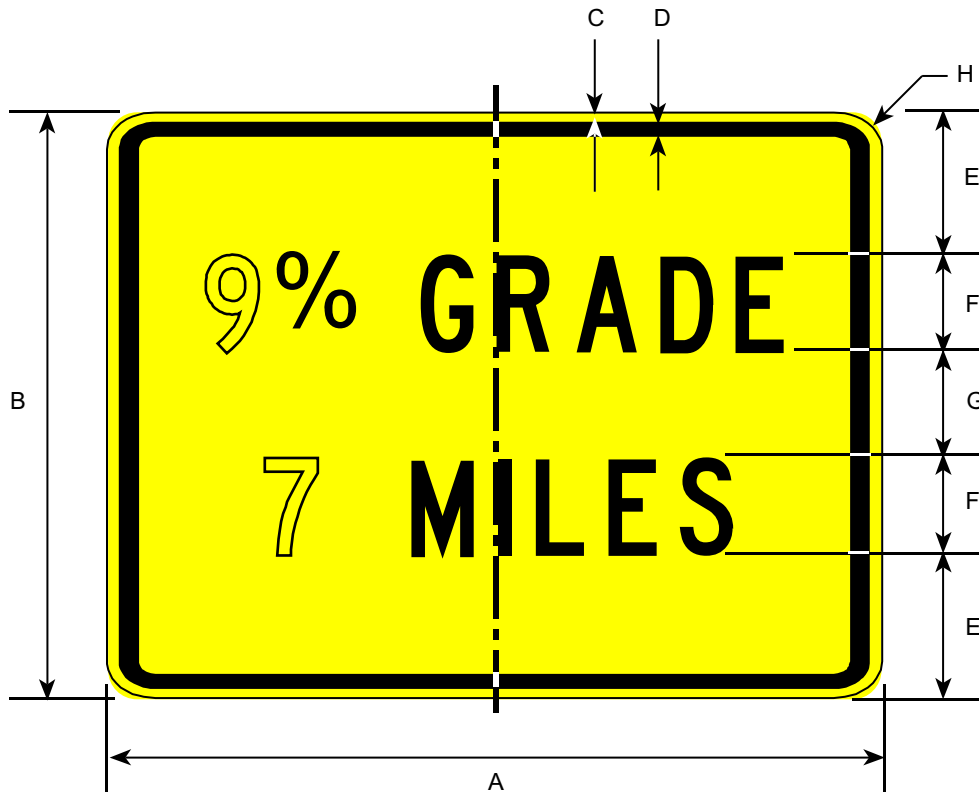

Border and Legend: Black
Background: Yellow

Road Class	Dimensions (inches)							
	A	B	C	D	E	F	G	H
Conv & Min	24	18	0.38	0.63	4	3C	4	1.5

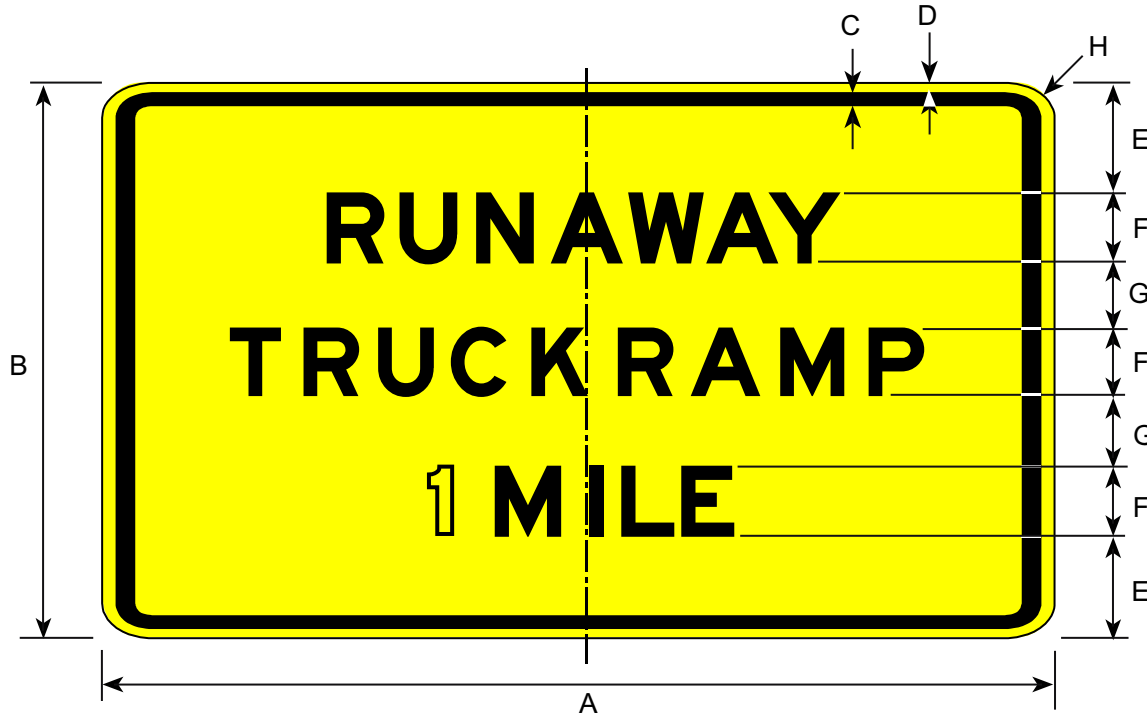

Border and Legend: Black
Background: Yellow

Road Class	Dimensions (inches)							
	A	B	C	D	E	F	G	H
Expwy/Fwy	78	48	1.25	0.75	9	6E	6	3

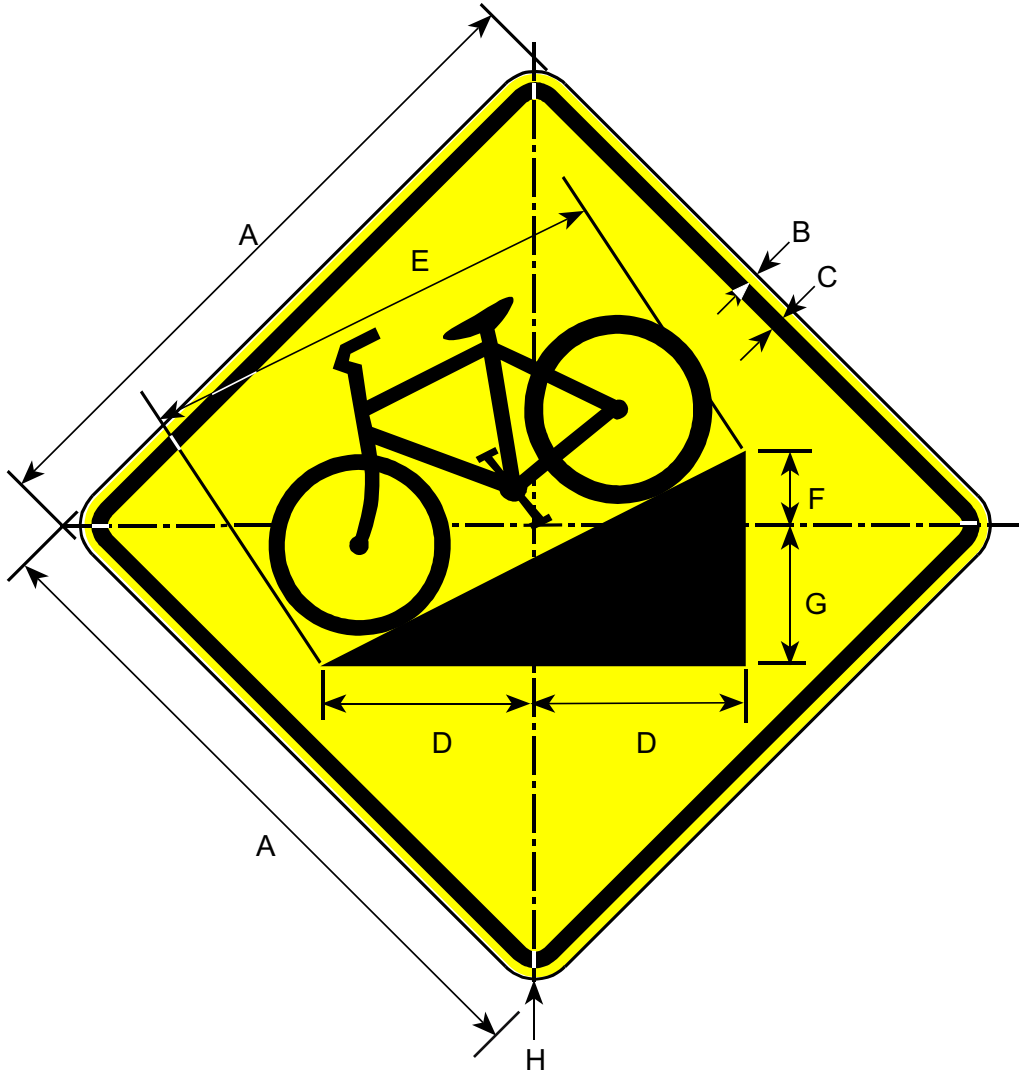

*Make symbol proportional to the graphic shown.

Border and Legend: Black
Background: Yellow

Road Class	Dimensions (inches)							
	A	B	C	D	E	F	G	H
Bike	18	0.38	0.63	5.63	12.63	1.75	4	1.5

W7-4B

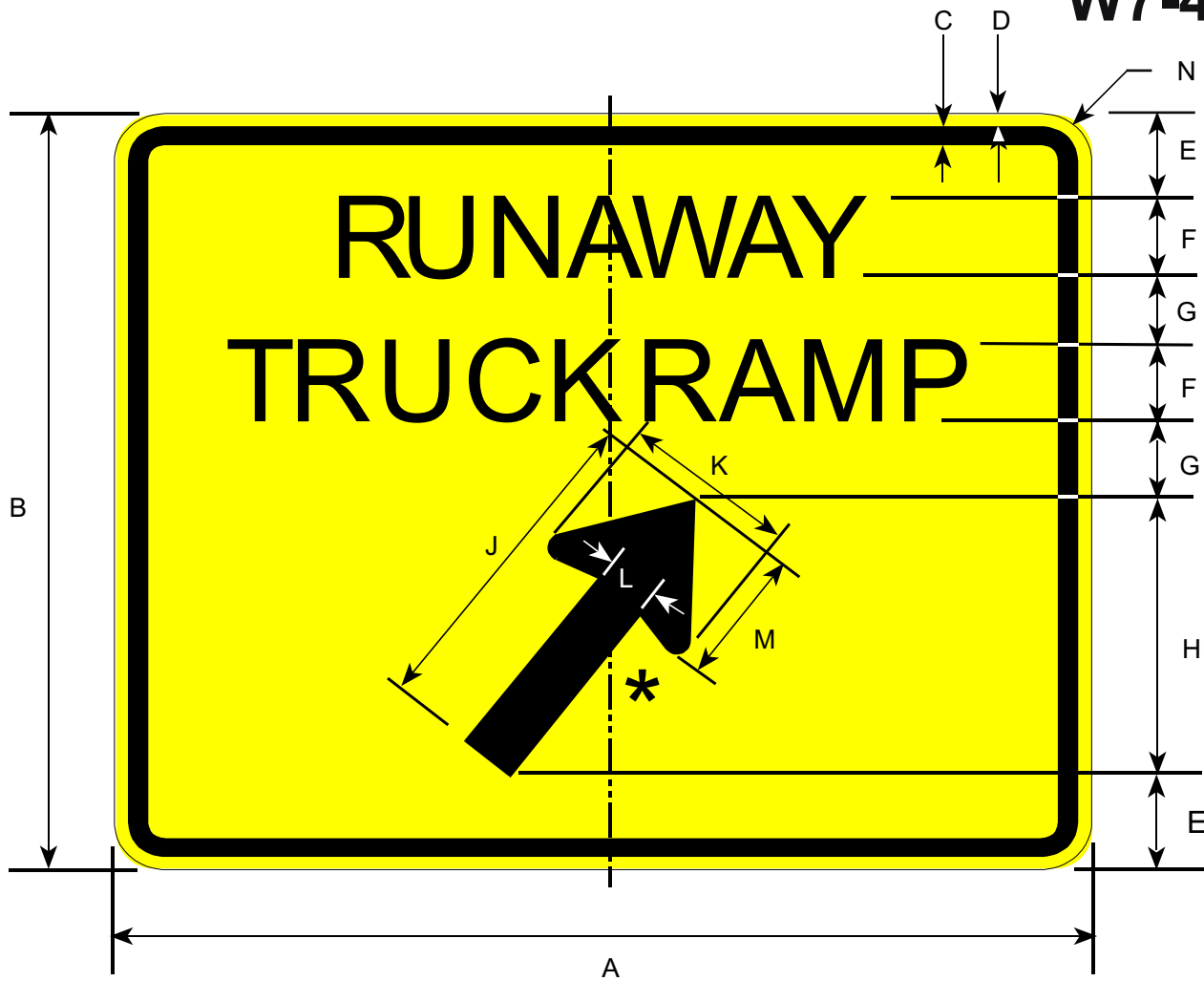

Border and Legend: Black
Background: Yellow

* See Appendix B-1 for Standard Arrow Details.

Prior to 2002 publication of this manual, this sign was numbered W7-4A.

Road Class	Dimensions (inches)												
	A	B	C	D	E	F	G	H	J	K	L	M	N
Expwy/Fwy	78	60	1.25	0.75	7.0	8C	5.0	20	27	15.13	3.75	11.56	3.0



Border and Legend: Black
Background: Yellow

W7-4D
W7-4E
W7-4F

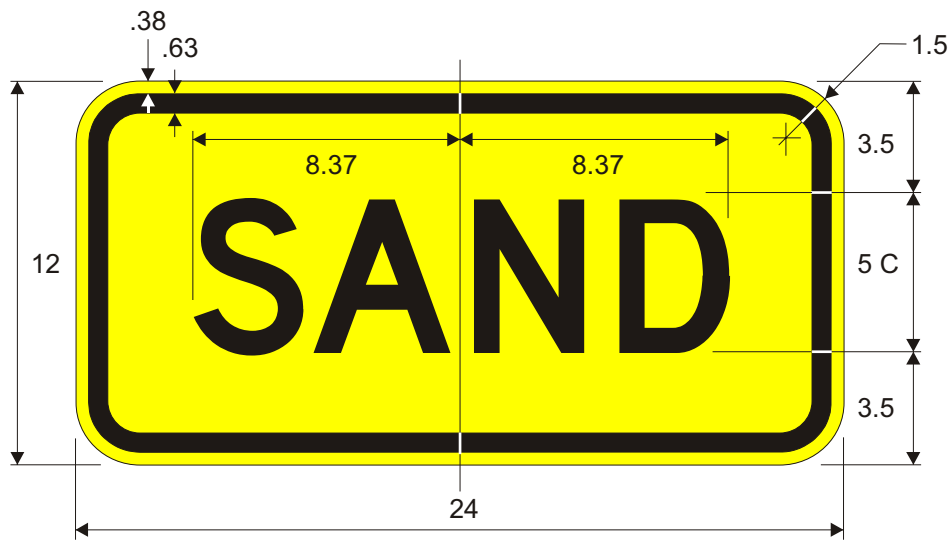

W7-4D

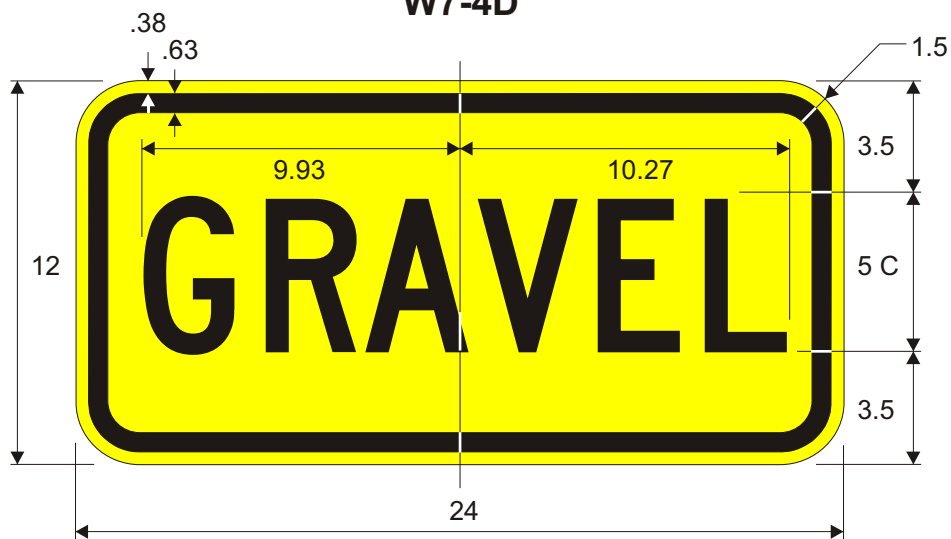

W7-4E

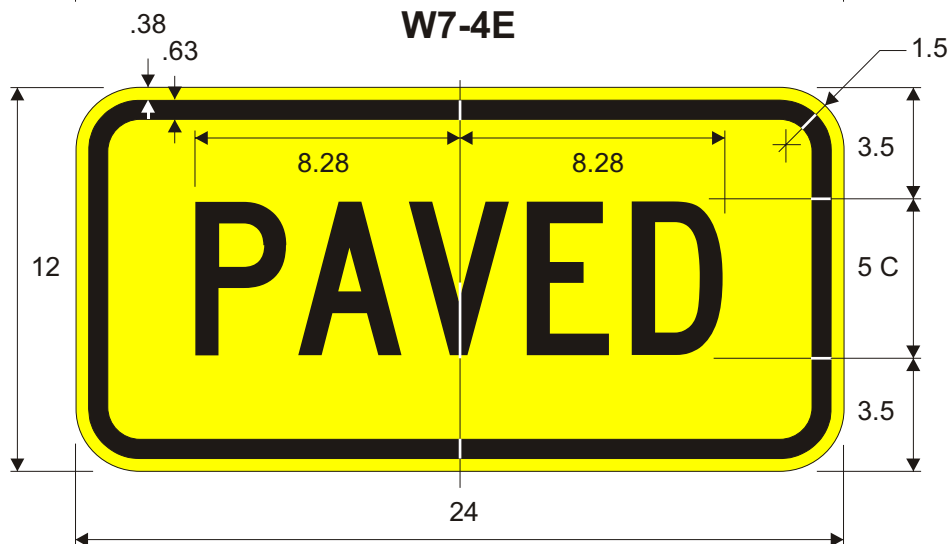

W7-4F

Border and Legend: Black
Background: Yellow

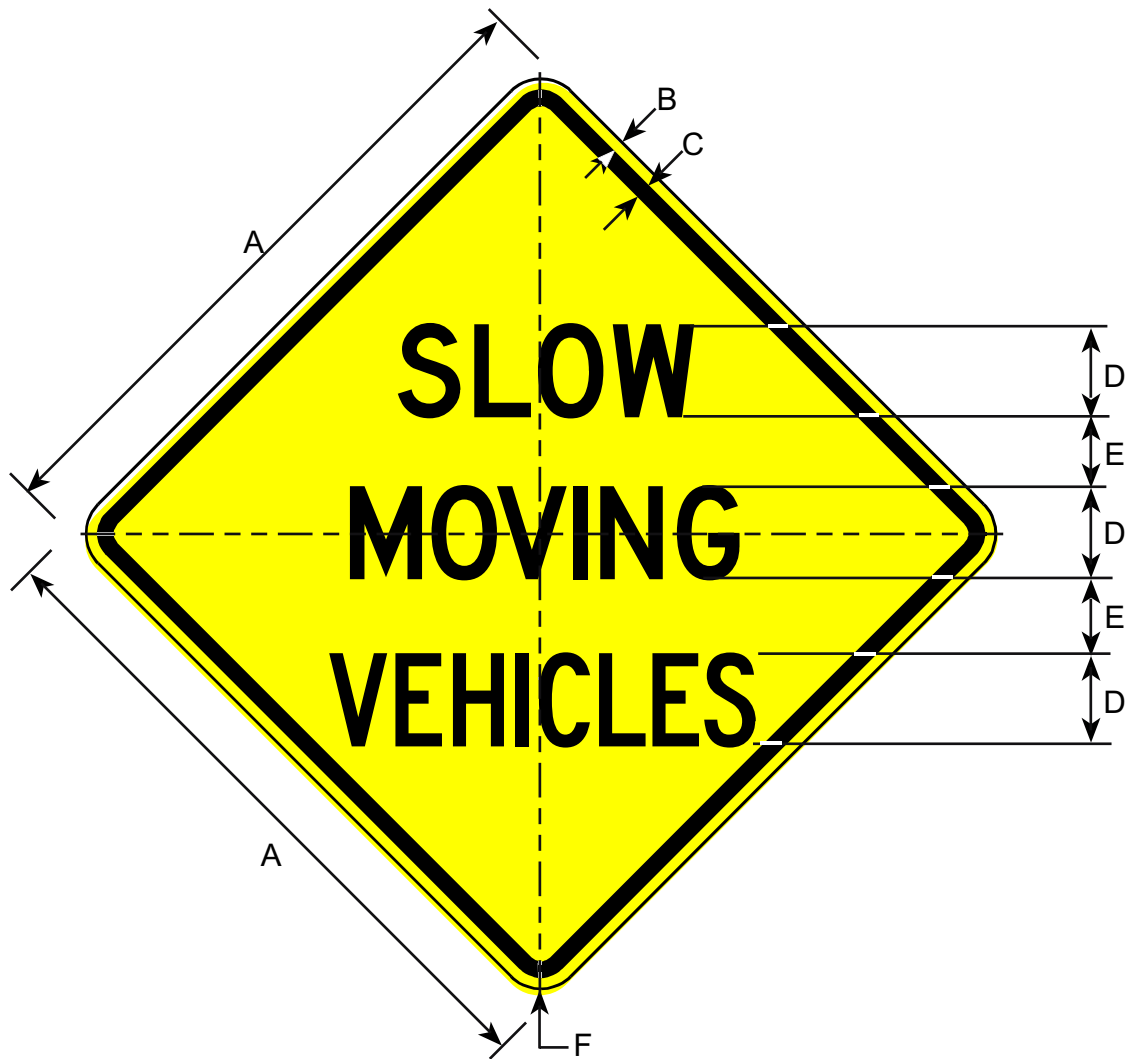

Border and Legend: Black
Background: Yellow

Prior to 2002 publication of this manual, this sign was numbered W7-6.

Road Class	Dimensions (inches)					
	A	B	C	D	E	F
Minimum	30	0.50	0.75	4C	3.0	1.88
Conventional	36	0.63	0.88	5C	3.5	2.25
Expwy/Fwy	48	0.75	1.25	7C	4.25	3.0

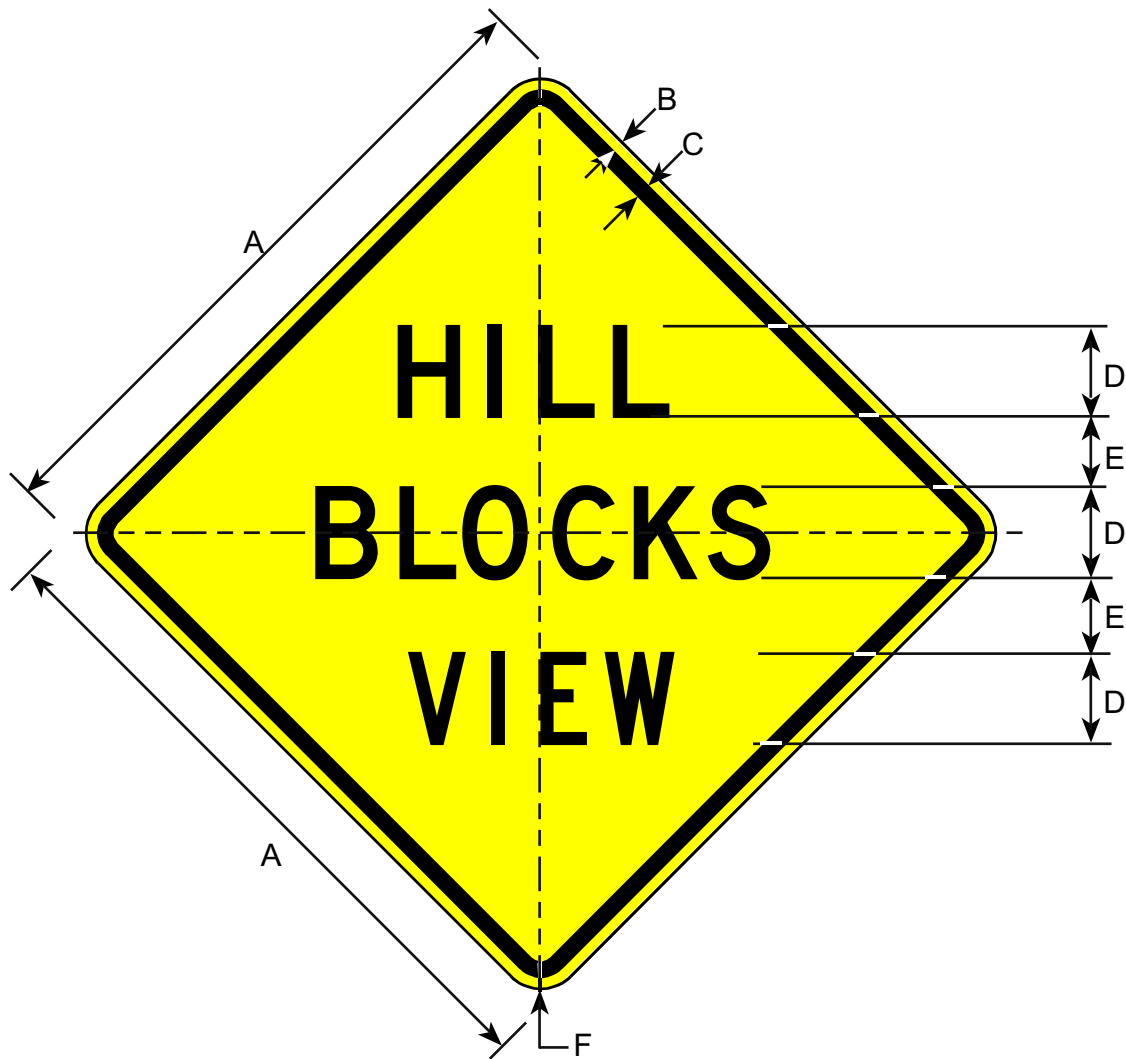

Border and Legend: Black
Background: Yellow

Road Class	Dimensions (inches)					
	A	B	C	D	E	F
Minimum	30	0.50	0.75	4D	2.5	1.88
Conventional	36	0.63	0.88	5D	3.0	2.25
Expwy/Fwy	48	0.75	1.25	7D	4.25	3.0

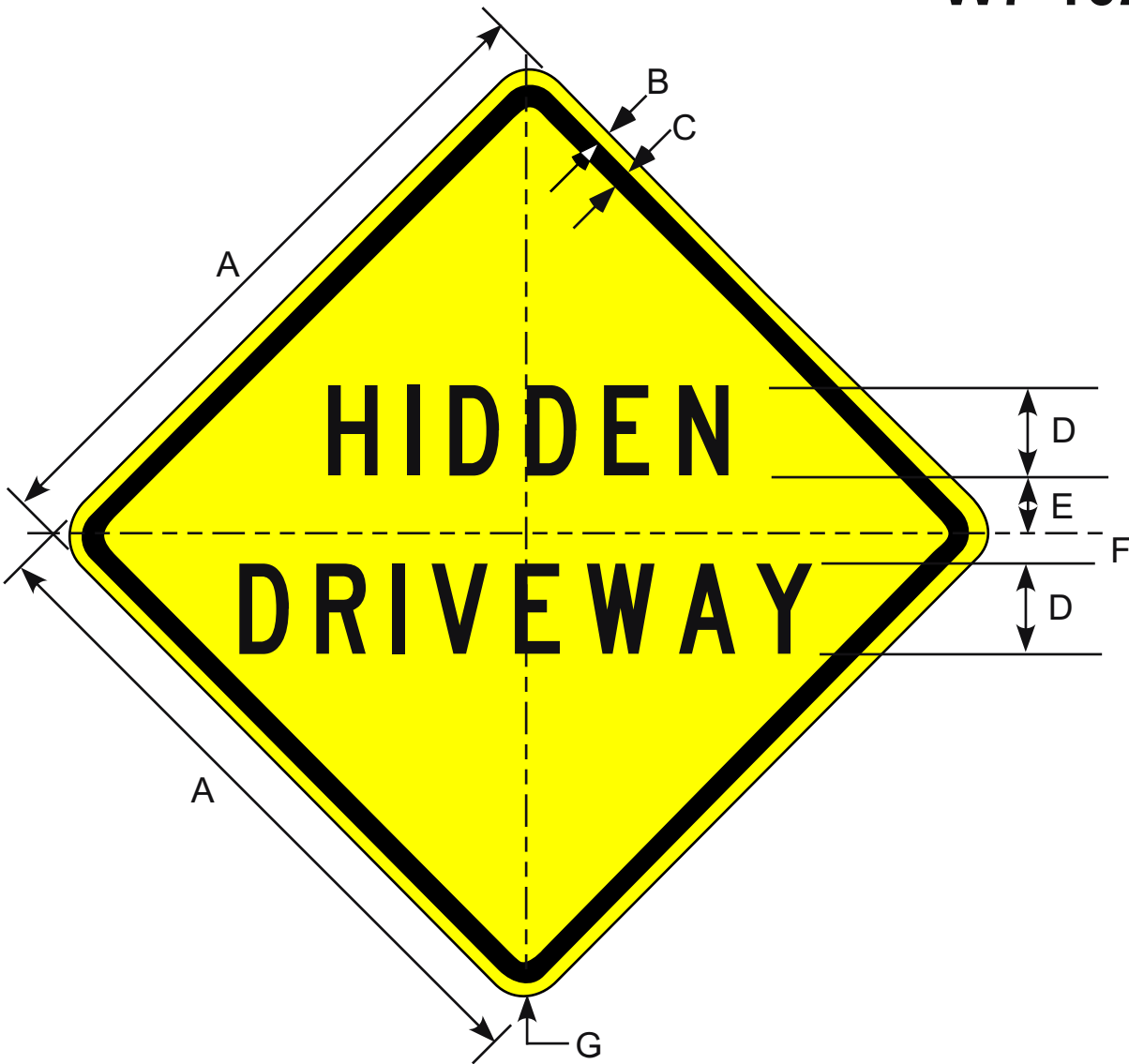

Border and Legend: Black
Background: Yellow

Road Class	Dimensions (inches)						
	A	B	C	D	E	F	G
Minimum	30	0.50	0.75	4C	2.50	1.25	1.88
Conventional	36	0.63	0.88	5C	3.25	1.63	2.25
Expwy/Fwy	48	0.75	1.25	7C	4.75	2.38	3.00

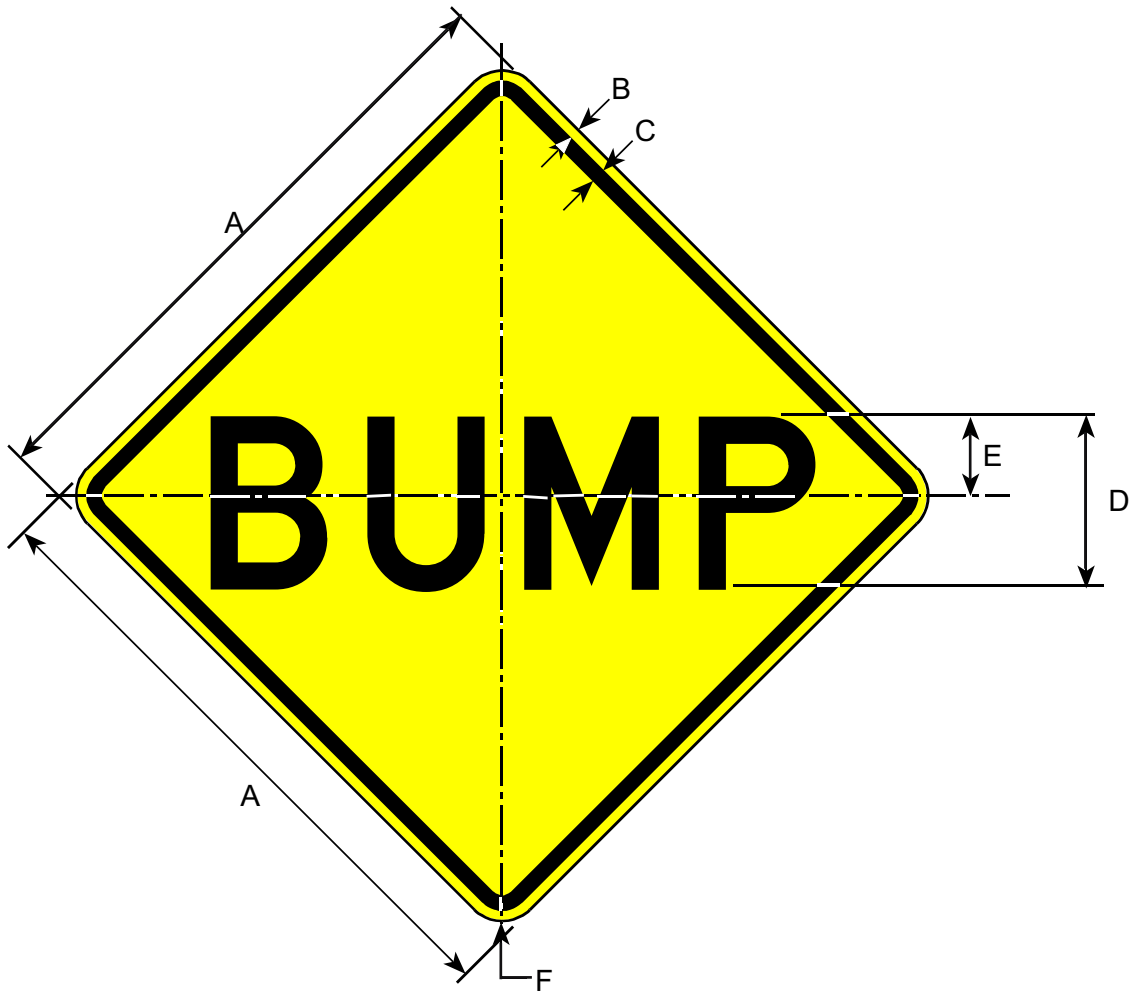

Border and Legend: Black
Background: Yellow

Road Class	Dimensions (inches)					
	A	B	C	D	E	F
Bike	24	0.38	0.63	6D	3	1.50
Minimum	30	0.50	0.75	8D	4	1.88
Conventional	36	0.63	0.88	10D	5	2.25
Expwy/Fwy	48	0.75	1.25	12D	6	3.00

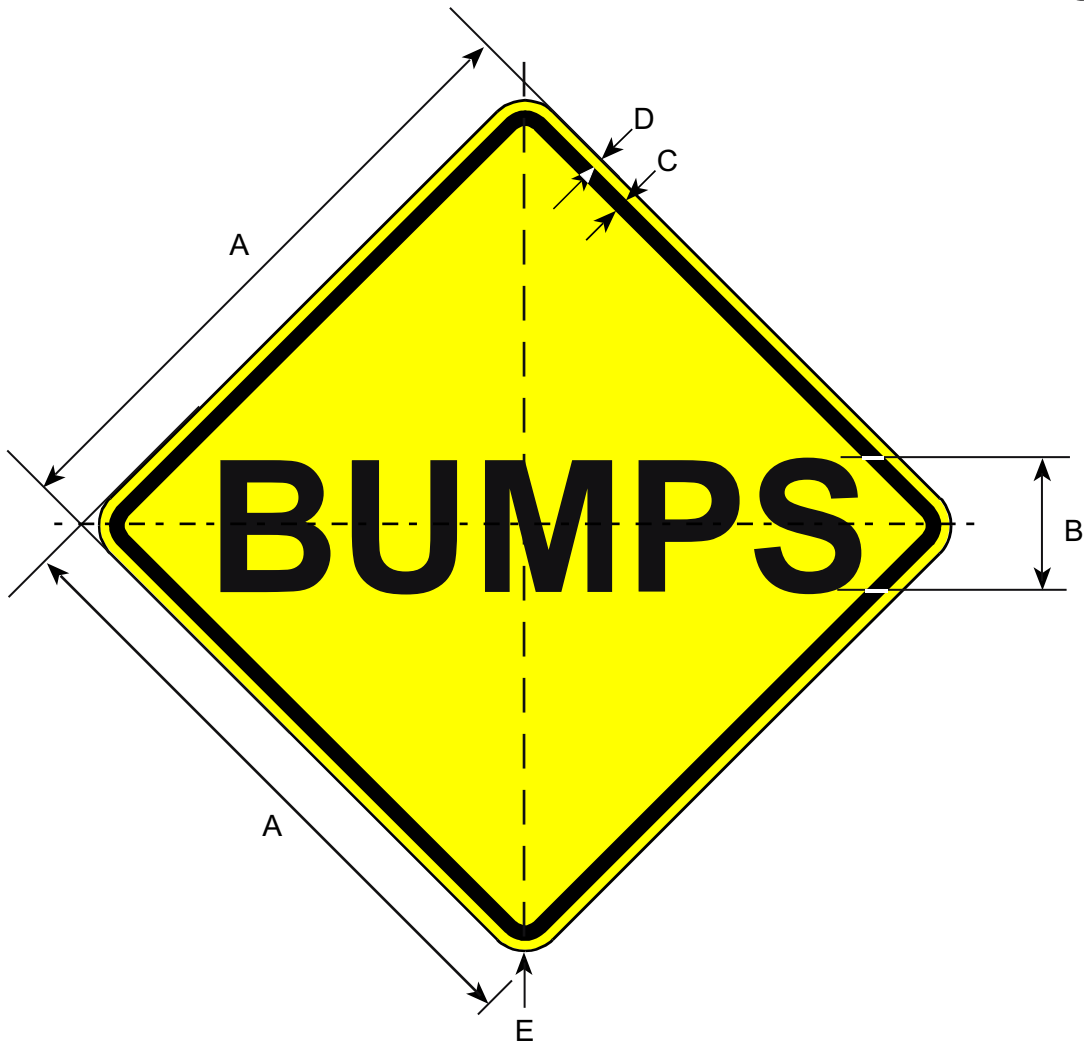

Border and Legend: Black
Background: Yellow

Road Class	Dimensions (inches)				
	A	B	C	D	E
Minimum	30	6D	0.75	0.50	1.88
Conventional	36	8D	0.88	0.63	2.25
Expwy/Fwy	48	10D	1.25	0.75	3.0

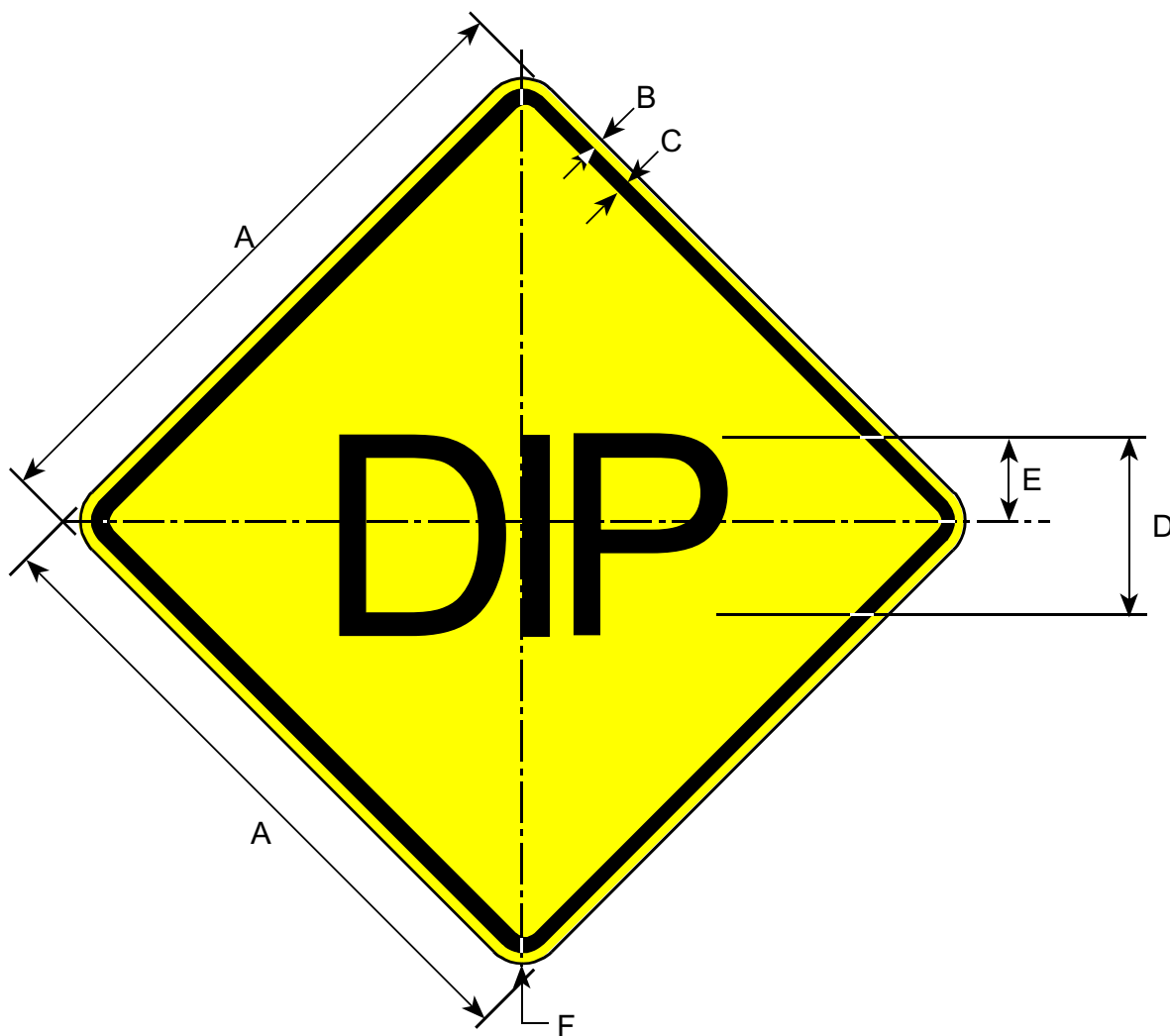

Border and Legend: Black
Background: Yellow

Road Class	Dimensions (inches)					
	A	B	C	D	E	F
Minimum	30	0.50	0.75	8E	4	1.88
Conventional	36	0.63	0.88	10E	5	2.25
Expwy/Fwy	48	0.75	1.25	12E	6	3.00

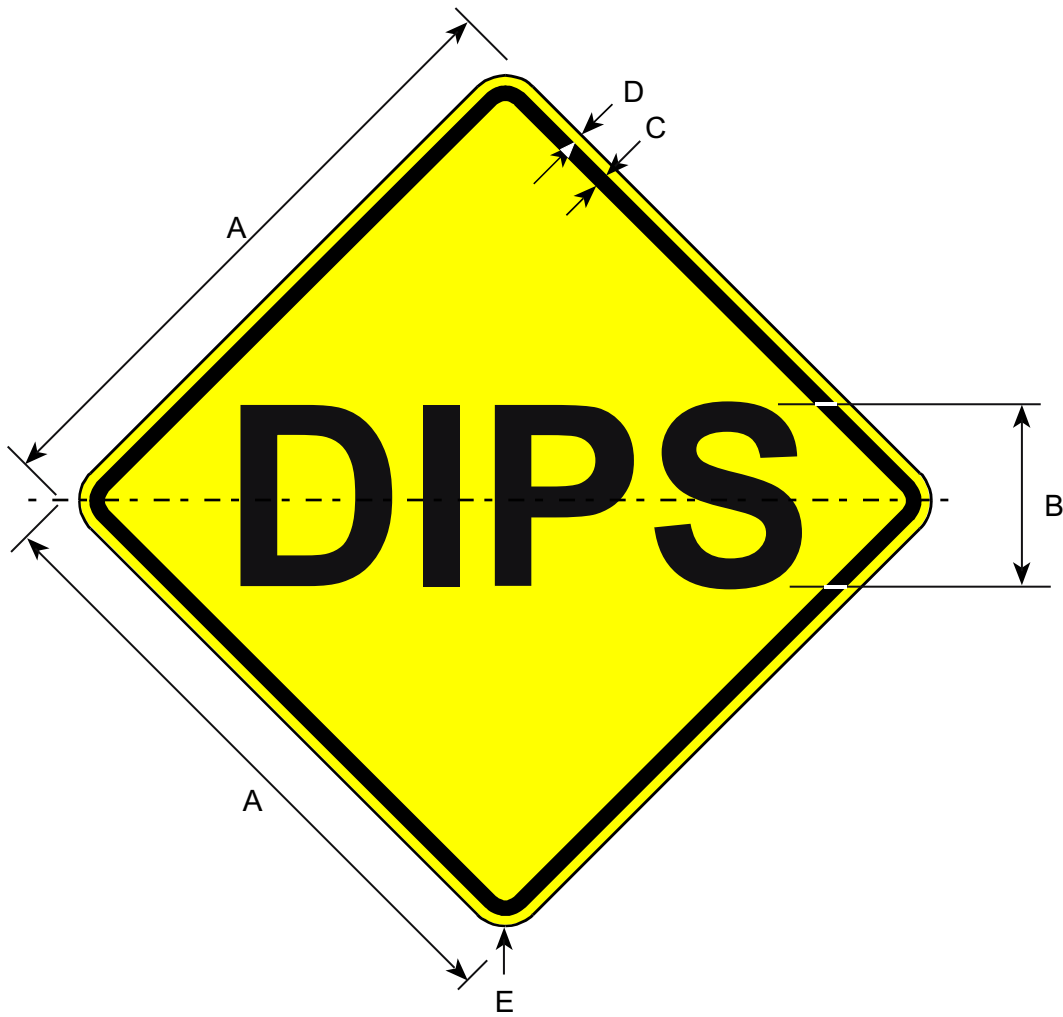

Border and Legend: Black
Background: Yellow

Road Class	Dimensions (inches)				
	A	B	C	D	E
Minimum	30	7E	0.75	0.50	1.88
Conventional	36	8E	0.88	0.63	2.25
Expwy/Fwy	48	10E	1.25	0.75	3.0

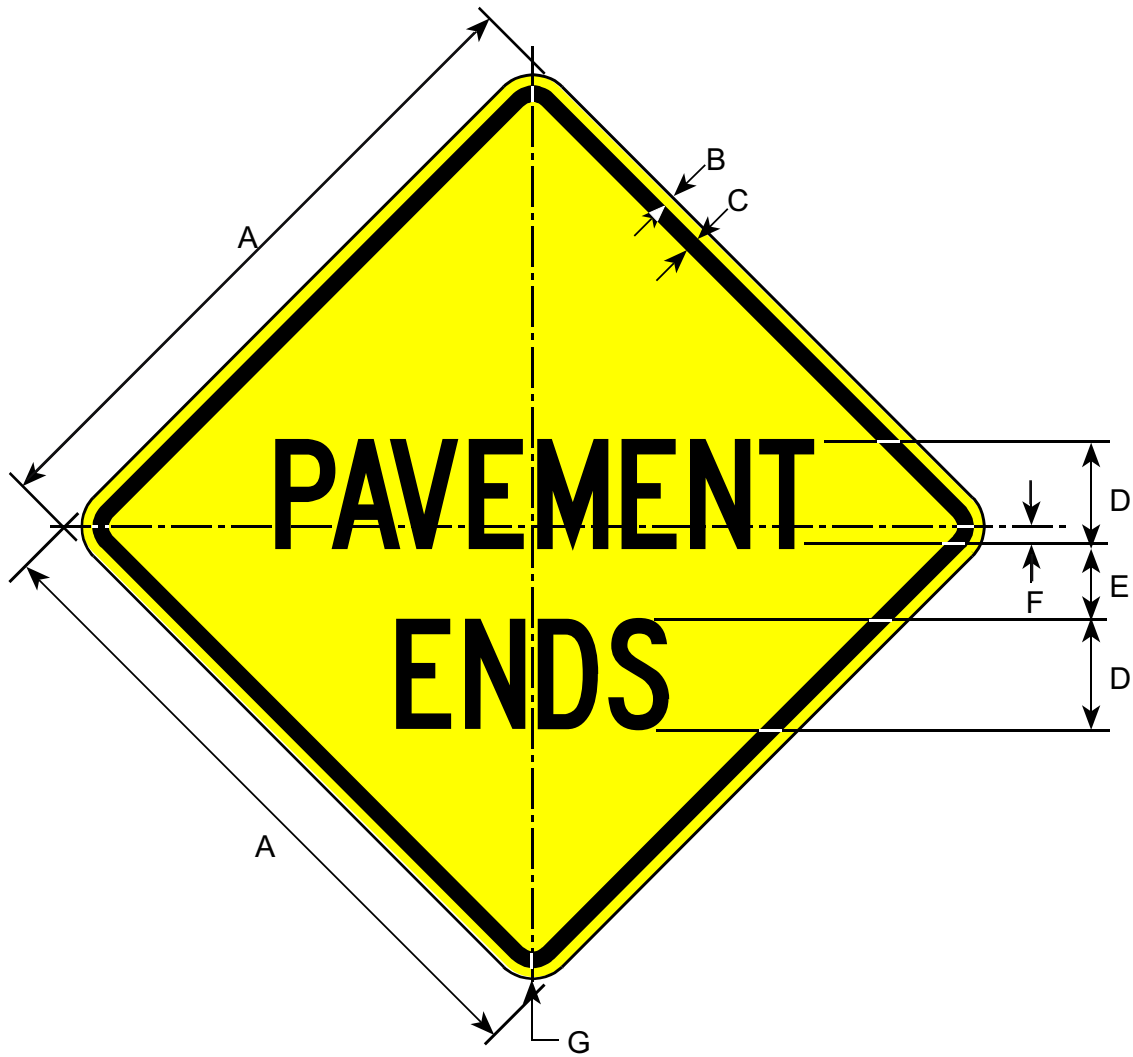

Border and Legend: Black
Background: Yellow

Road Class	Dimensions (inches)						
	A	B	C	D	E	F	G
Bike	18	0.38	0.63	4C	2.5	0.50	1.5
Conventional	36	0.63	0.88	6C	3.5	1.0	2.25
Expwy/Fwy	48	0.75	1.25	8C	4.5	1.5	3.0

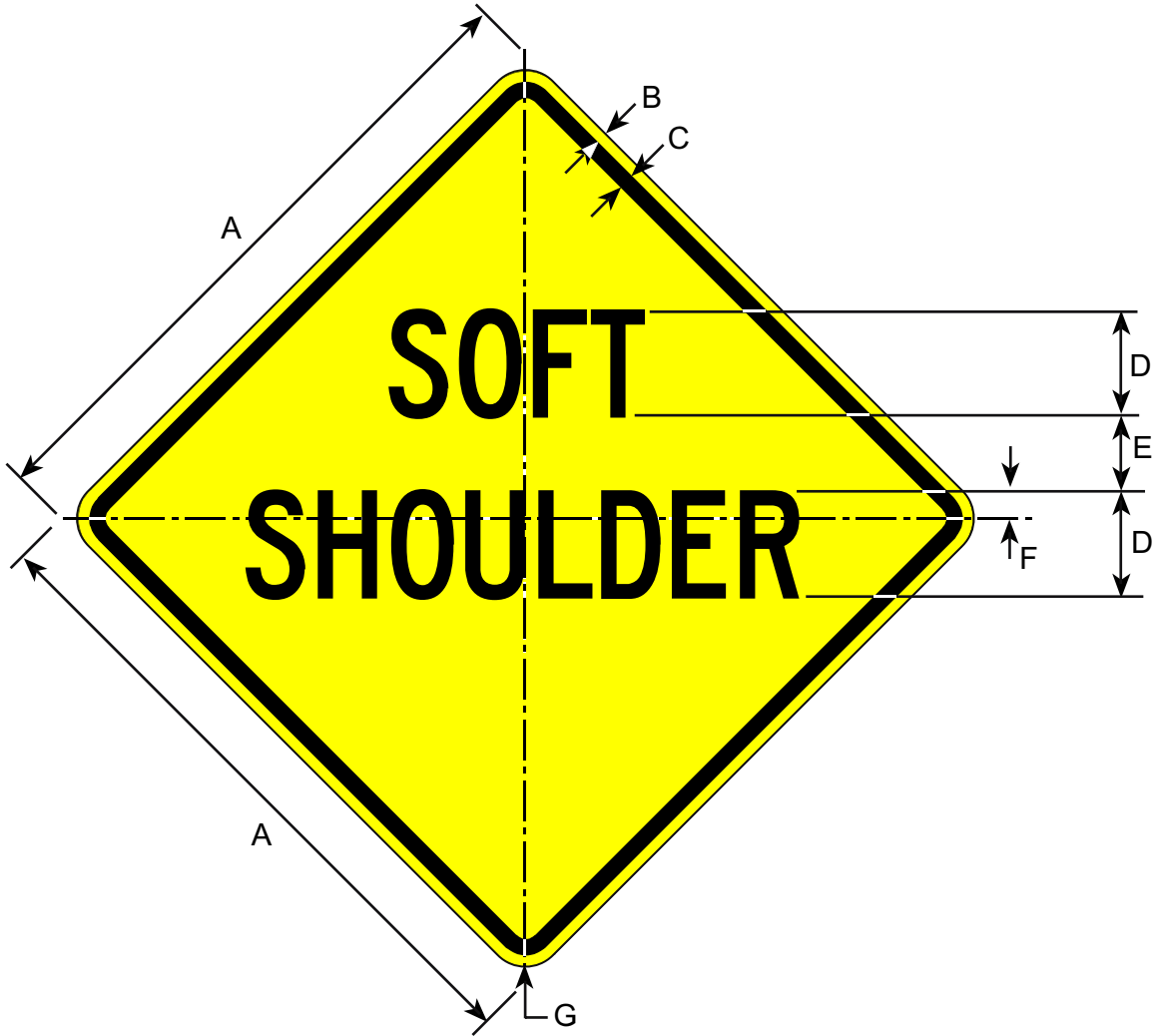

Border and Legend: Black
Background: Yellow

Road Class	Dimensions (inches)						
	A	B	C	D	E	F	G
Minimum	30	0.50	0.75	5C	3.0	0.75	1.88
Conventional	36	0.63	0.88	6C	3.5	1.00	2.25
Expwy/Fwy	48	0.75	1.25	8C	5.0	1.25	3.00

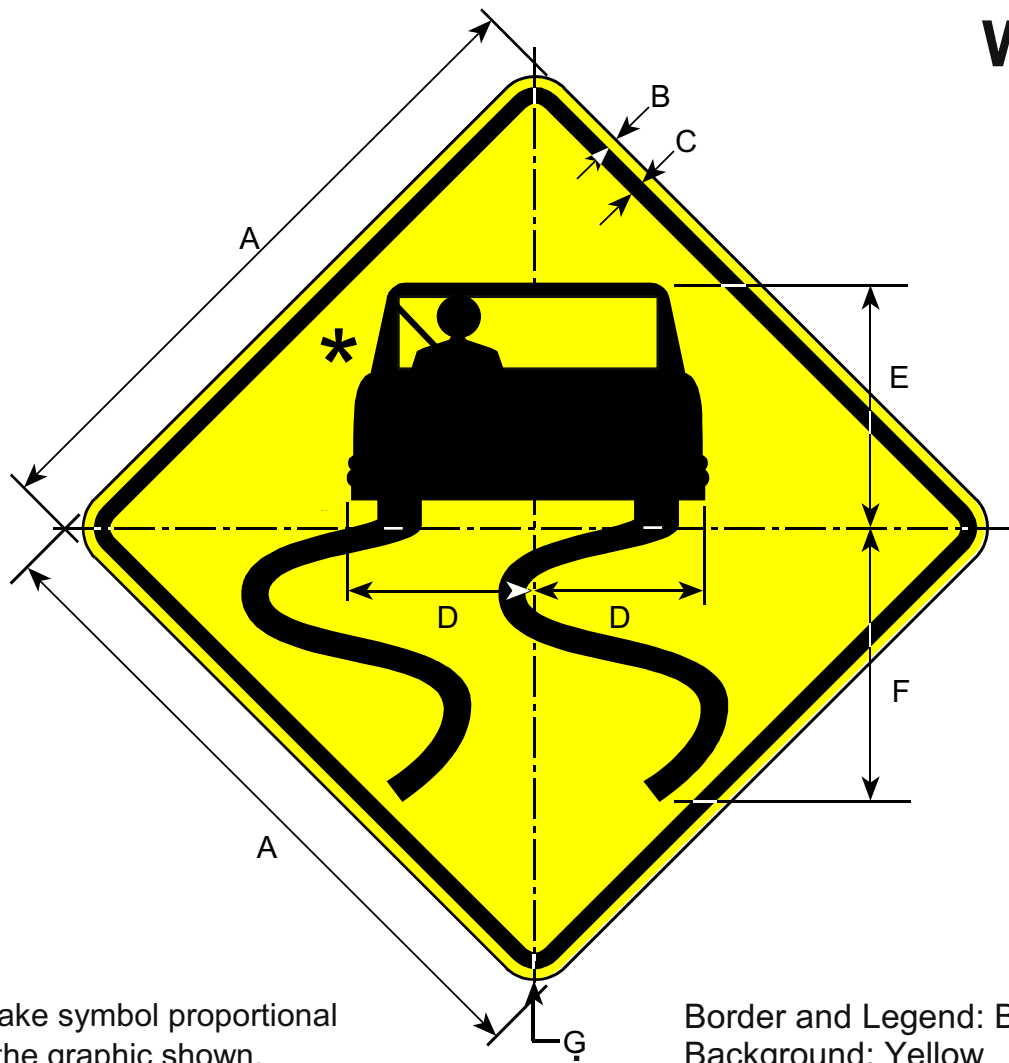

Sign shall only be used with
W8-5P-Slippery When Wet (Plate)

Road Class	Dimensions (inches)						
	A	B	C	D	E	F	G
Minimum	30	0.50	0.75	8.0	11	12.5	1.88
Conventional	36	0.63	0.88	9.5	13	14.81	2.25
Expwy/Fwy	48	0.75	1.25	12.63	17.33	19.75	3.0



Border and Legend: Black
Background: Yellow

Plate shall only be used with
W8-5 - Slippery When Wet

Road Class	Dimensions (inches)													
	A	B	C	D	E	F	G	H	J	K	L	M	N	
Conventional	24	18	0.38	0.63	4.0	4C	3C	3.0	8.69	8.63	9.88	10	1.5	

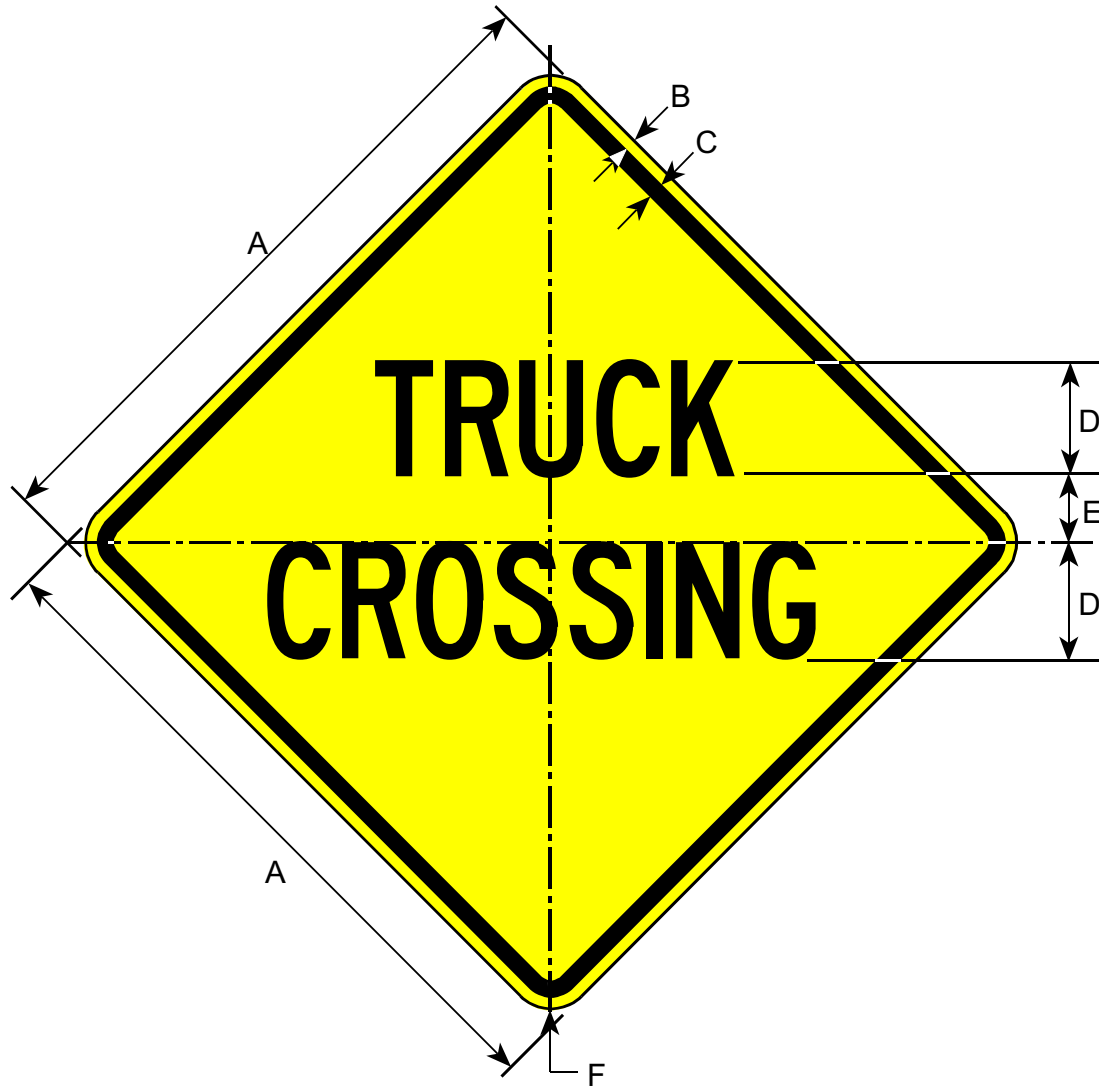

Border and Legend: Black
Background: Yellow

Road Class	Dimensions (inches)					
	A	B	C	D	E	F
Minimum	30	0.50	0.75	5C	3.0	1.88
Conventional	36	0.63	0.88	6C	3.5	2.25
Expwy/Fwy	48	0.75	1.25	8C	5.0	3.00

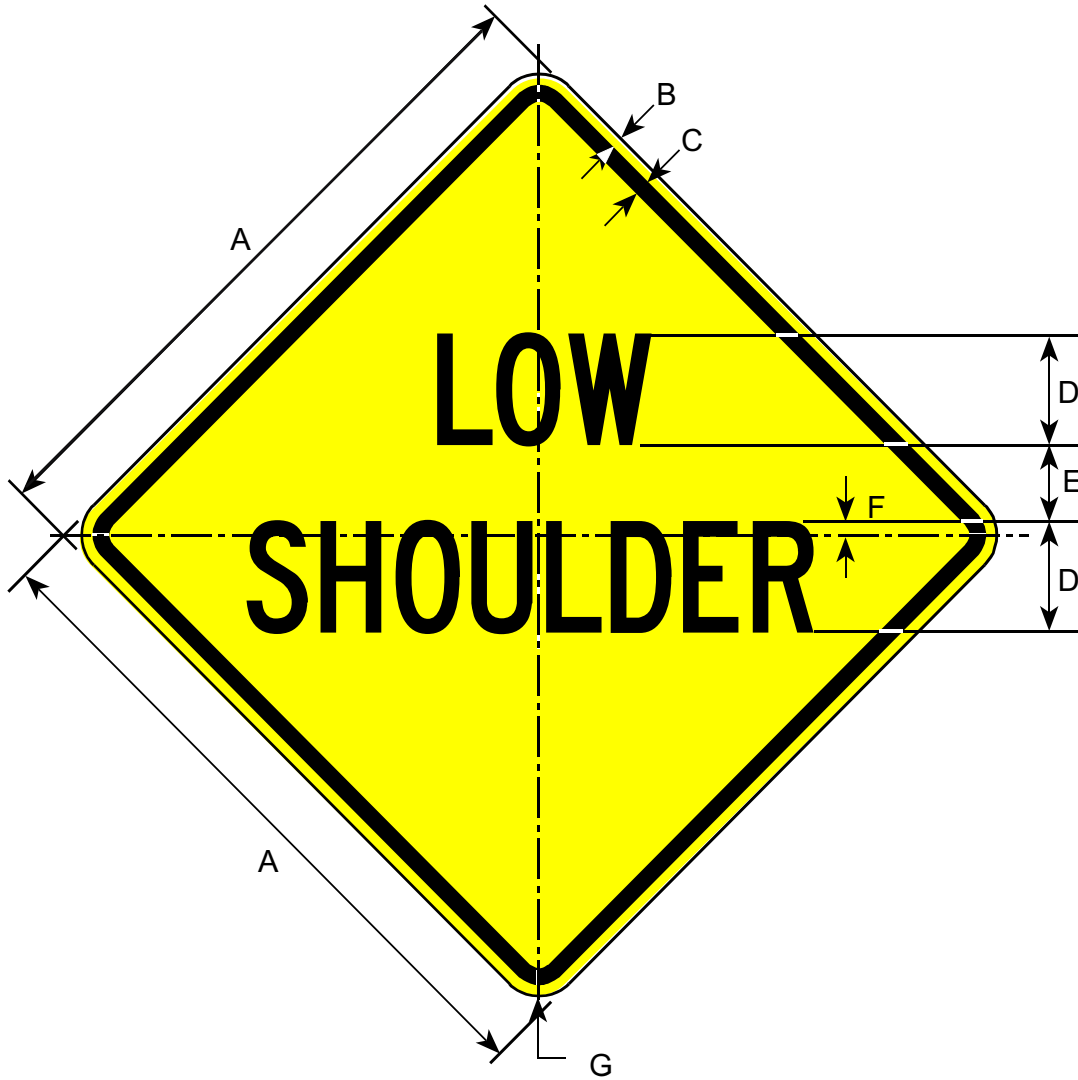

Border and Legend: Black
Background: Yellow

Road Class	Dimensions (inches)						
	A	B	C	D	E	F	G
Minimum	30	0.50	0.75	5C	3.0	0.75	1.88
Conventional	36	0.63	0.88	6C	3.5	1.00	1.25
Expwy/Fwy	48	0.75	1.25	8C	5.0	1.25	3.00

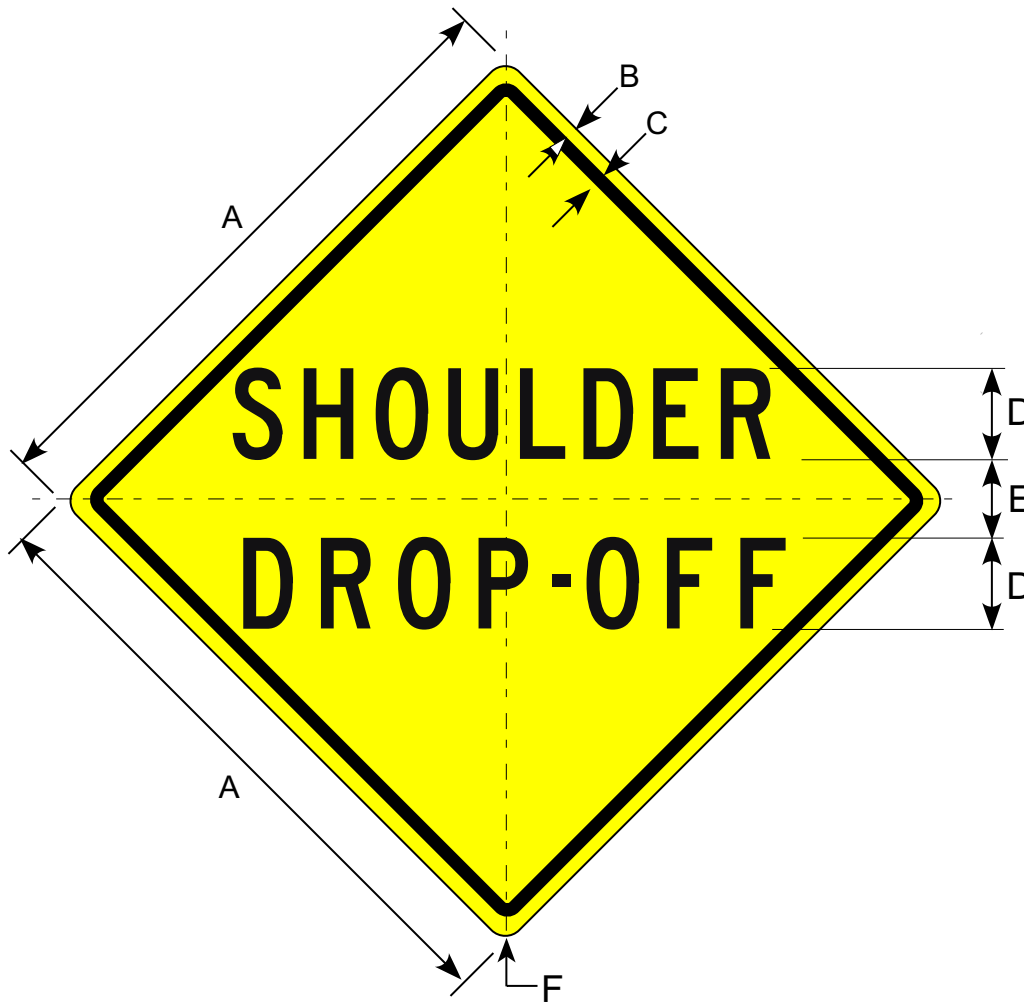

Border and Legend: Black
Background: Yellow

Road Class	Dimensions (inches)					
	A	B	C	D	E	F
Minimum	30	0.50	0.75	5C	3.75	1.9
Conventional	36	0.63	0.88	6C	4.50	2.3
Expwy/Fwy	48	0.75	1.25	7C	6.00	3.0

W8-10 W8-10A

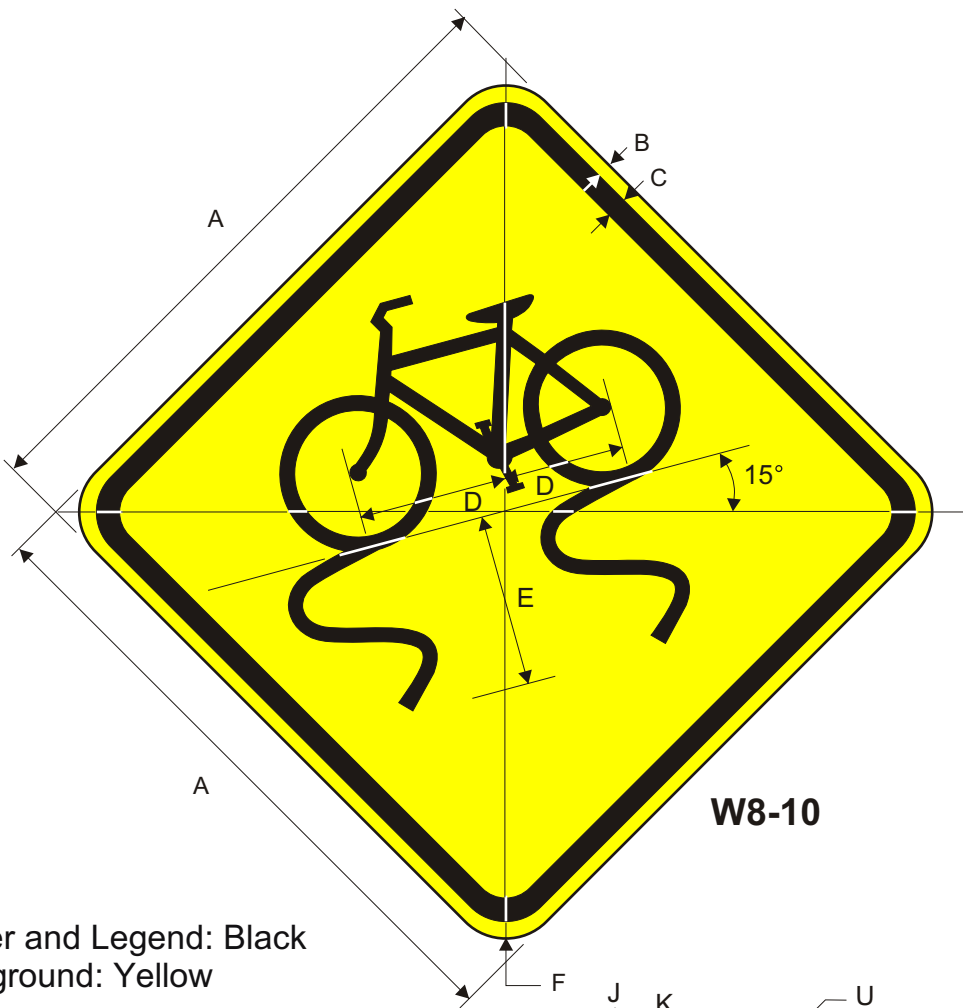

Border and Legend: Black
Background: Yellow

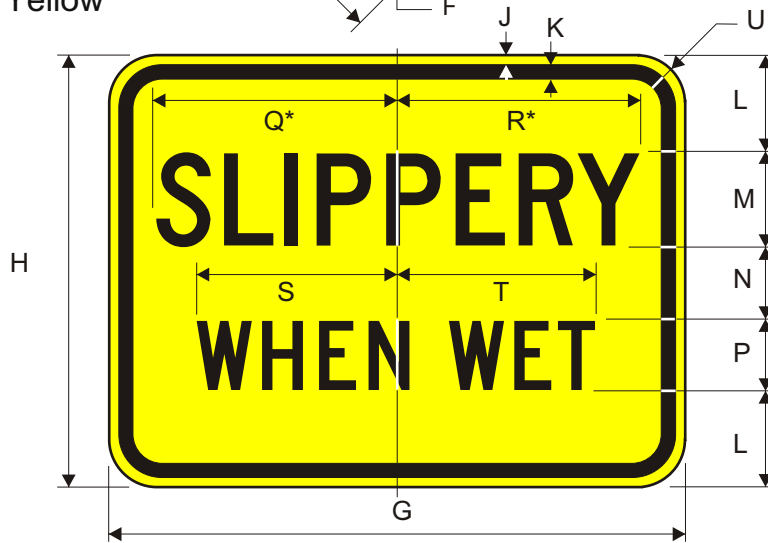

W8-10a

*Reduce spacing 25%

Road Class	Dimensions (inches)											
	A	B	C	D	E	F	G	H	J	K	L	M
Shared Use Path	18	0.38	0.63	3.63	4.66	1.5	12	9.0	0.38	0.38	2.0	2C
Roadway	24	0.38	0.63	4.83	6.21	1.5	24	18	0.38	0.63	4.0	4C

N	P	Q	R	S	T	U
1.5	1.5C	5.0	5.25	4.63	4.25	1.5
3.0	3C	10	10.38	9.0	8.63	1.5

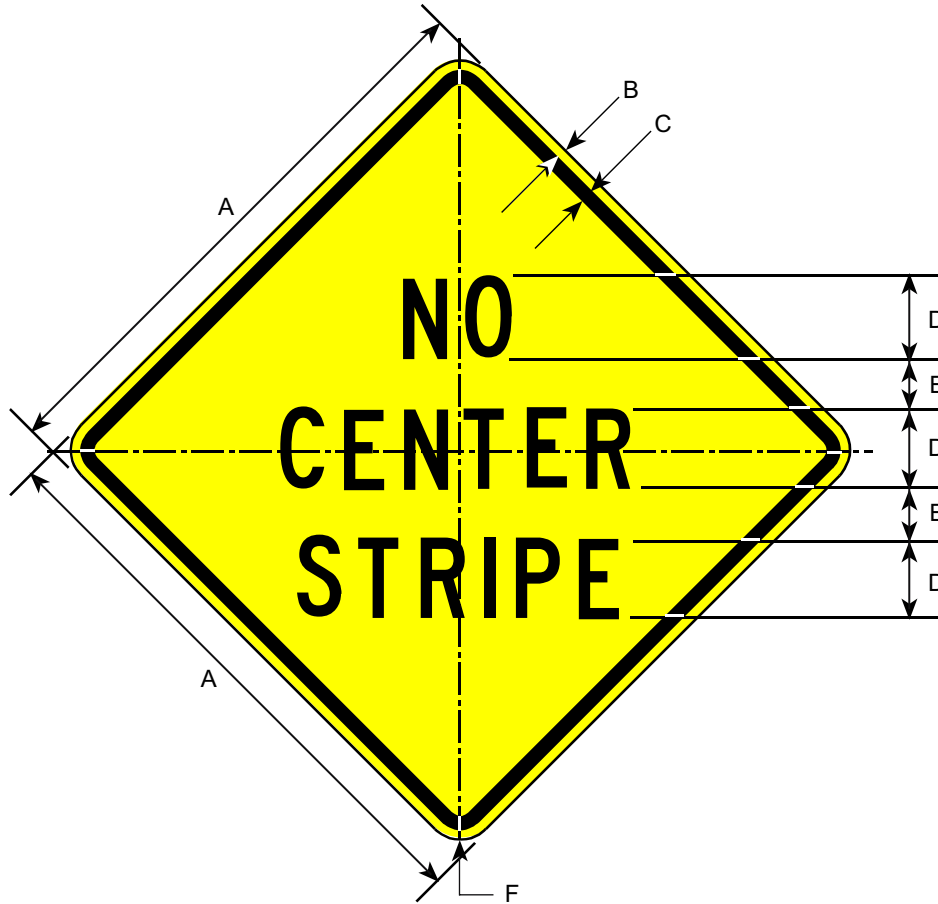

Border and Legend: Black
Background: Yellow

Road Class	Dimensions (inches)					
	A	B	C	D	E	F
Minimum	30	0.50	0.75	4C	2.50	1.88
Conventional	36	0.63	0.88	5C	3.25	2.25
Expwy/Fwy	48	0.75	1.25	7C	4.50	3.00

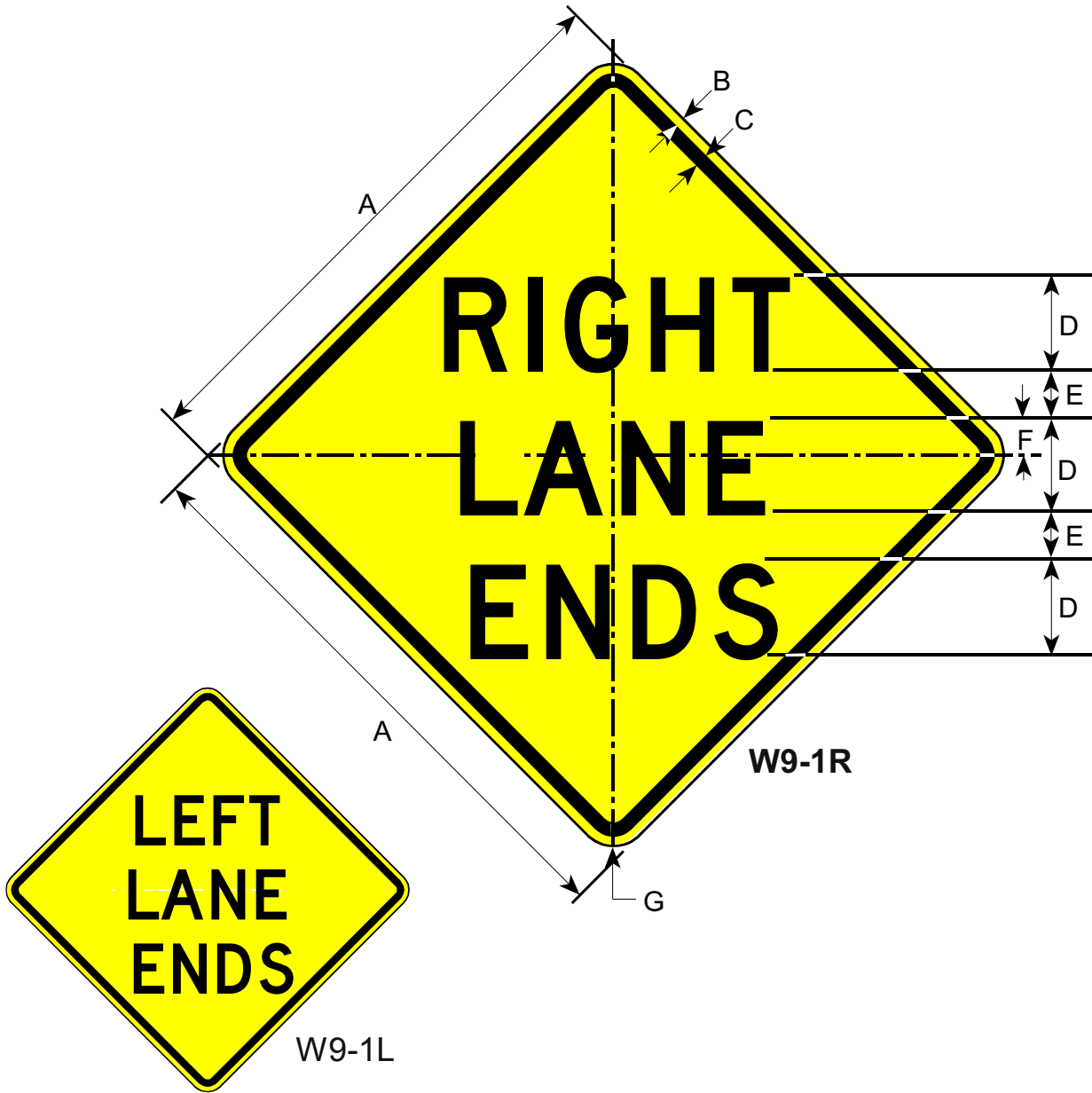

Border and Legend: Black
Background: Yellow

Road Class	Dimensions (inches)						
	A	B	C	D	E	F	G
Minimum	30	0.50	0.75	5D	2.5	1.5	1.88
Conventional	36	0.63	0.88	6D	3.0	2.0	2.25
Expwy/Fwy	48	0.75	1.25	8D	4.0	3.0	3.0

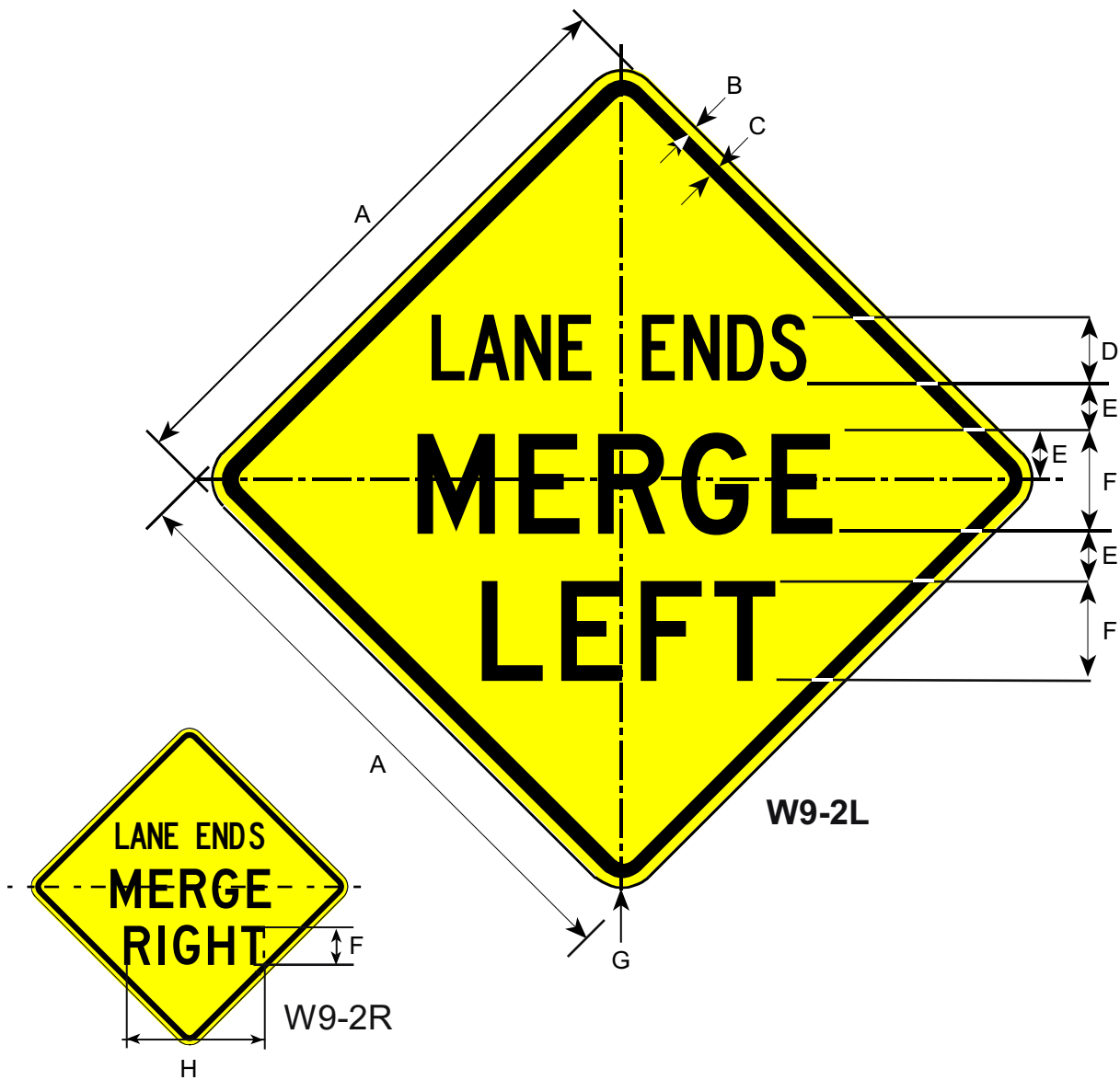

Border and Legend: Black
 Background: Yellow

Road Class	Dimensions (inches)							
	A	B	C	D	E	F	G	H
Minimum	30	0.50	0.75	3C	2.5	5D	1.88	18.38
Conventional	36	0.63	0.88	4C	3.0	6D	2.25	22
Expwy/Fwy	48	0.75	1.25	6C	4.0	8D	3.0	29.5

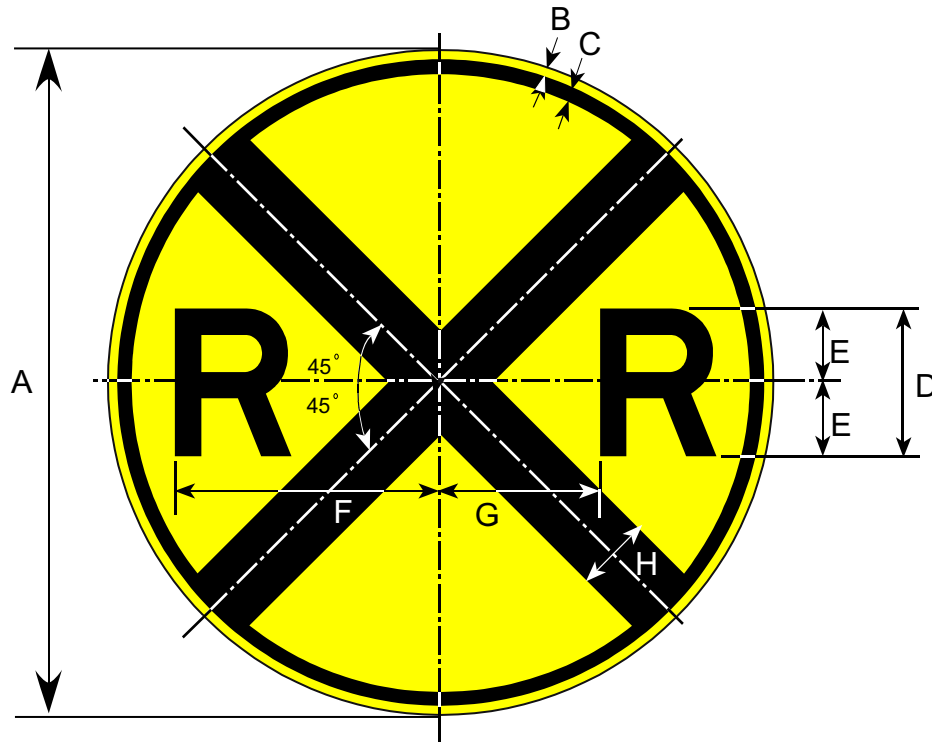

Border and Legend: Black
Background: Yellow

Make symbol proportional
to the one shown.

Road Class	Dimensions (inches)							
	A	B	C	D	E	F	G	H
Minimum	30	0.38	0.63	7E	3.5	12.38	7.13	3.0
Conventional	36	0.50	0.75	8E	4.0	14.38	8.63	4.0
Expwy/Fwy	48	0.75	1.25	10E	5.0	18.38	11.63	5.0

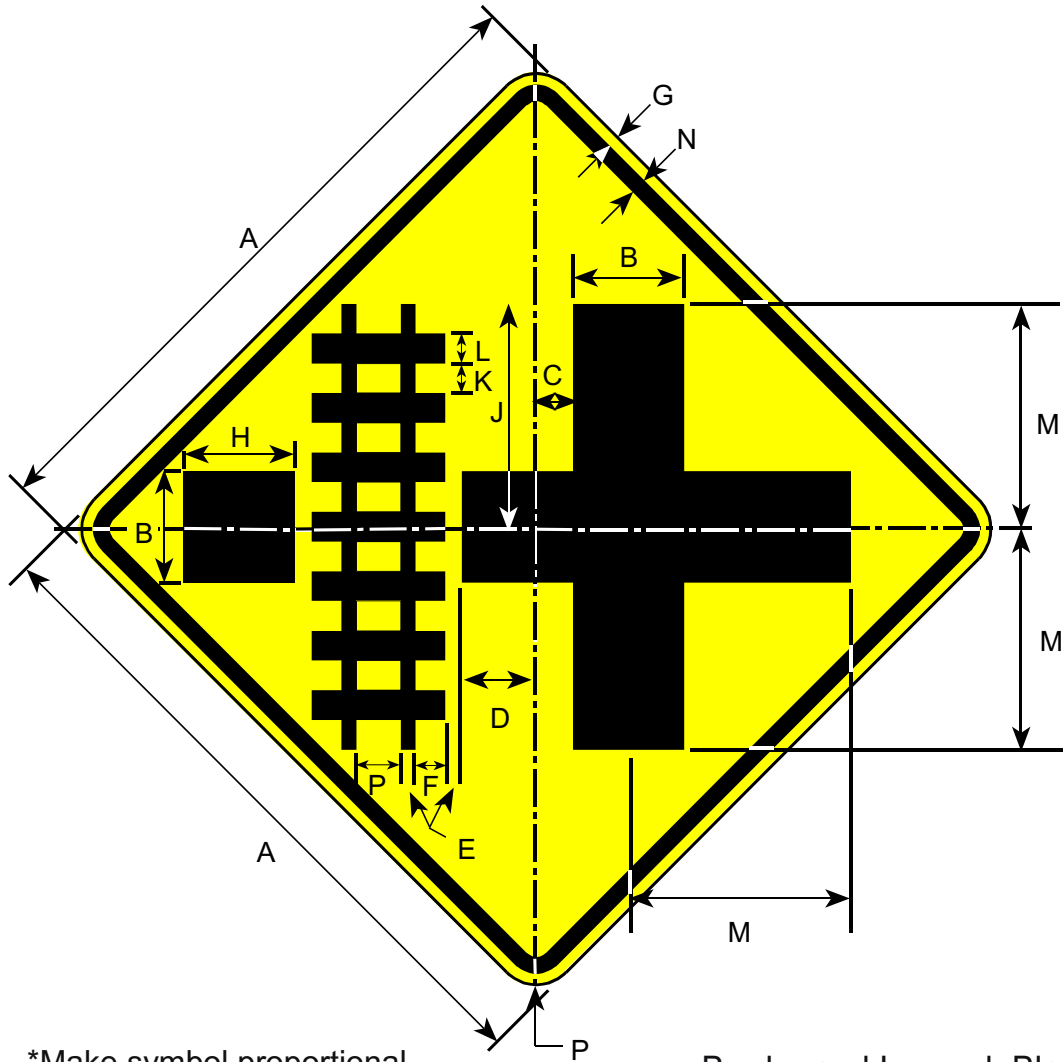

*Make symbol proportional to the graphic shown.

Border and Legend: Black
Background: Yellow

Prior to the 2002 publication of this manual, this sign was numbered W10-4.

Road Class	Dimensions (inches)													
	A	B	C	D	E	F	G	H	J	K	L	M	N	P
Minimum	30	4.13	3.5	4.75	0.63	0.88	0.50	2.88	8.38	1.13	1.25	10.38	0.75	1.88
Conventional	36	5.0	4.25	5.75	0.75	1.13	0.63	3.5	10.06	1.38	1.5	12.5	0.88	2.25
Expwy/Fwy	48	6.63	5.63	7.88	1.0	1.5	0.75	4.63	13.13	1.75	2.0	16.56	1.25	3.0

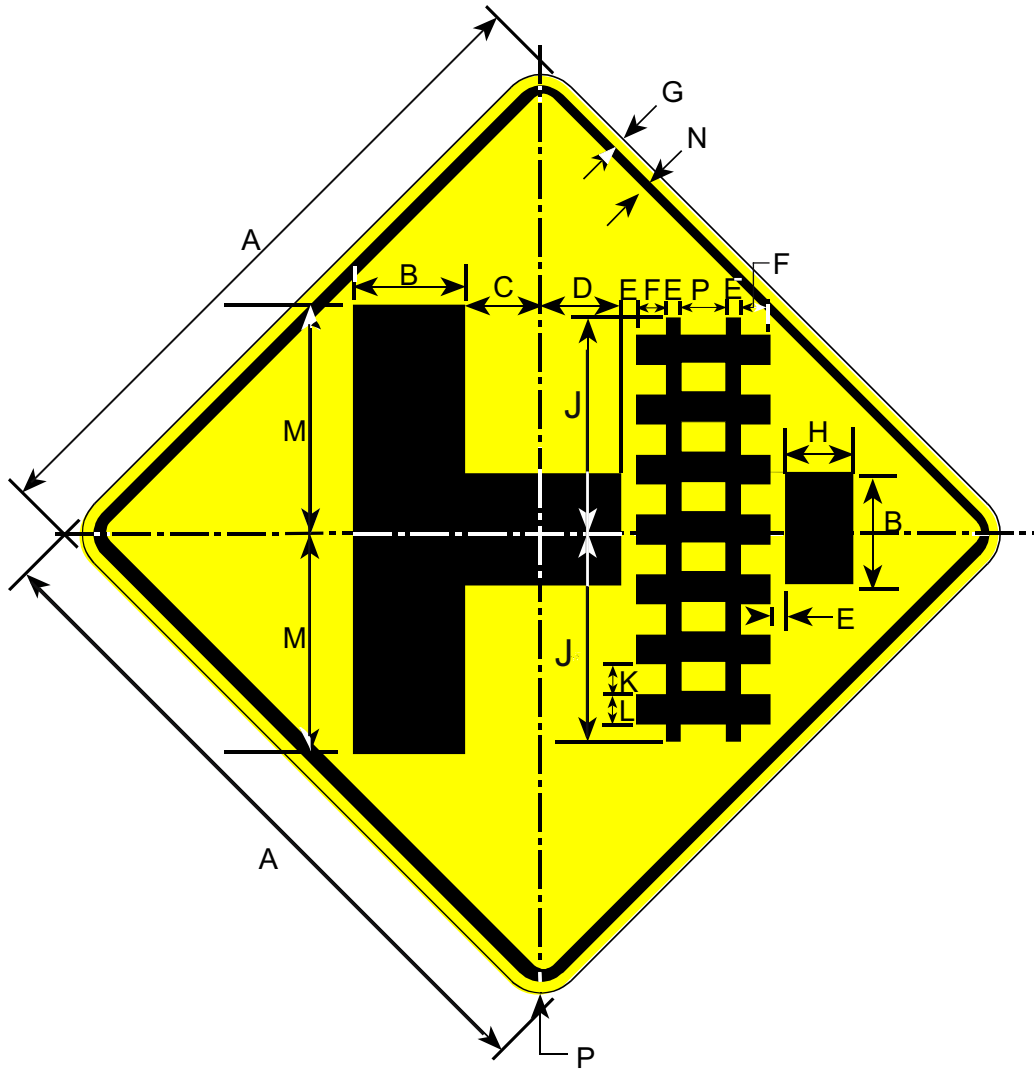

*Make symbol proportional to the graphic shown.

Border and Legend: Black
Background: Yellow

Road Class	Dimensions (inches)													
	A	B	C	D	E	F	G	H	J	K	L	M	N	P
Minimum	30	4.13	3.50	4.75	0.63	0.88	0.50	2.88	8.38	1.13	1.25	10.38	0.75	1.88
Conventional	36	5.00	4.25	5.75	0.75	1.13	0.63	3.50	10.06	1.38	1.50	12.50	0.88	2.25
Expwy/Fwy	48	6.63	5.63	7.88	1.00	1.50	0.75	4.63	13.13	1.75	2.00	16.56	1.25	3.00

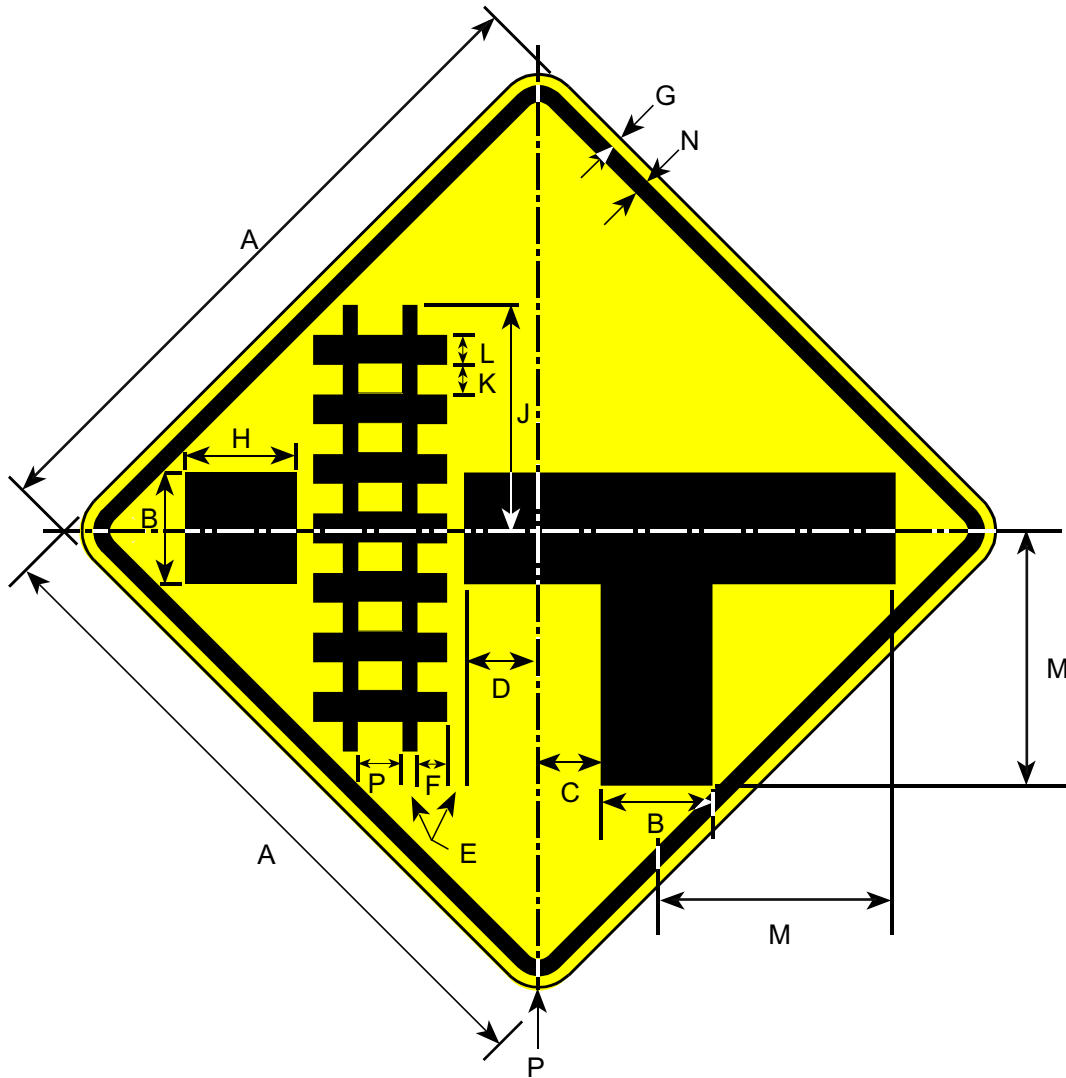

*Make symbol proportional to the graphic shown.

Border and Legend: Black
Background: Yellow

Road Class	Dimensions (inches)													
	A	B	C	D	E	F	G	H	J	K	L	M	N	P
Minimum	30	4.25	3.5	4.75	0.63	0.88	0.50	2.88	8.38	1.13	1.25	10.38	0.75	1.88
Conventional	36	5.0	4.25	5.75	0.75	1.13	0.63	3.5	10.06	1.38	1.5	12.5	0.88	2.25
Expwy/Fwy	48	6.63	5.63	7.88	1.0	1.5	0.75	4.63	13.13	1.75	2.0	16.56	1.25	3.0

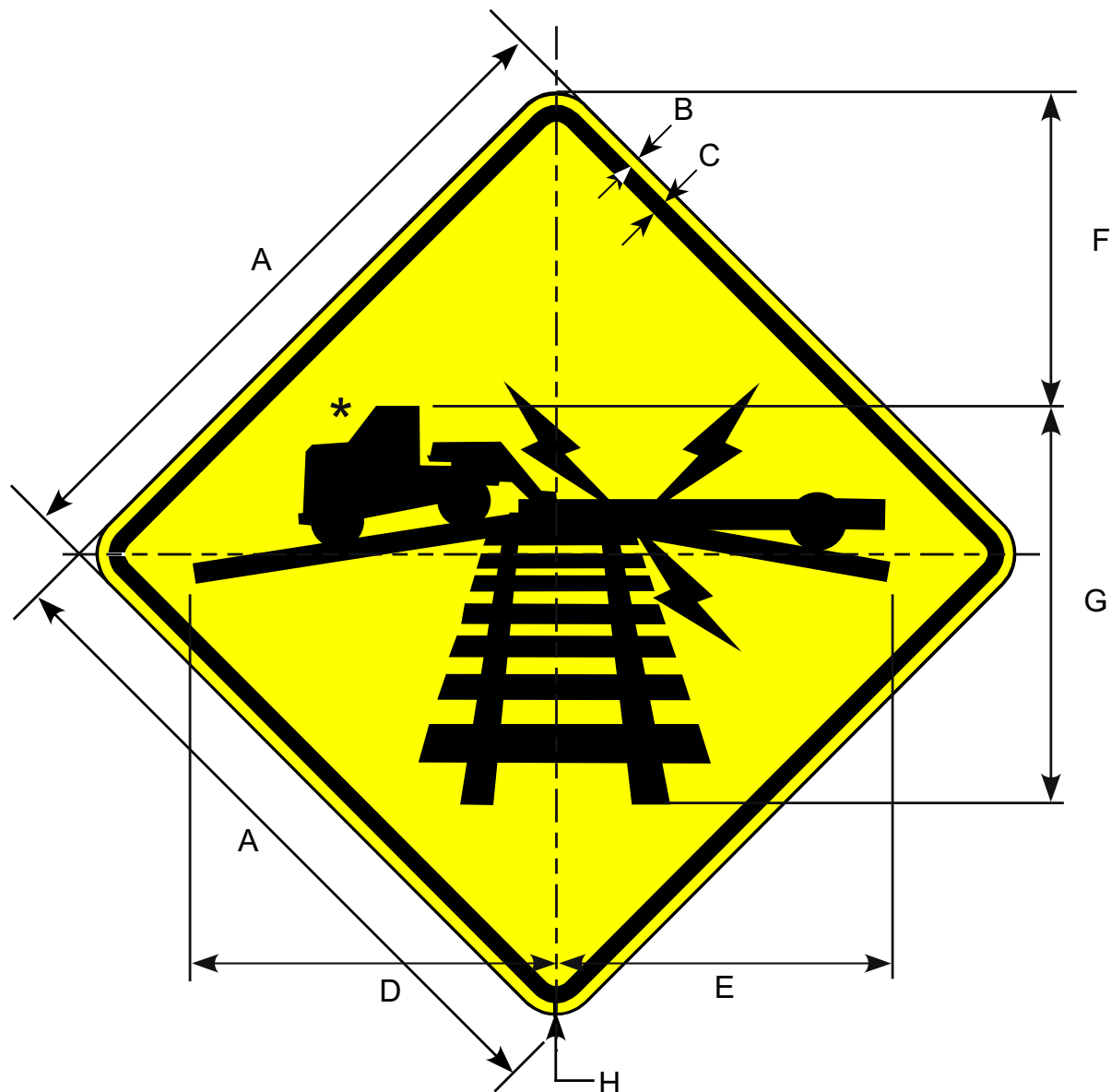

Border and Legend: Black
Background : Yellow

* Make symbol proportional
to the one shown.

Road Class	Dimensions (inches)							
	A	B	C	D	E	F	G	H
Minimum	30	0.50	0.75	15.69	15.25	13.41	17.53	1.88
Conventional	36	0.63	0.88	19.29	18.89	15.45	21.62	2.25
Expwy/Fwy	48	0.75	1.25	24.86	24.46	20.62	27.86	3.00

W10-9 W10-10



W10-9

Sign Shall Only Be Used With W10-1

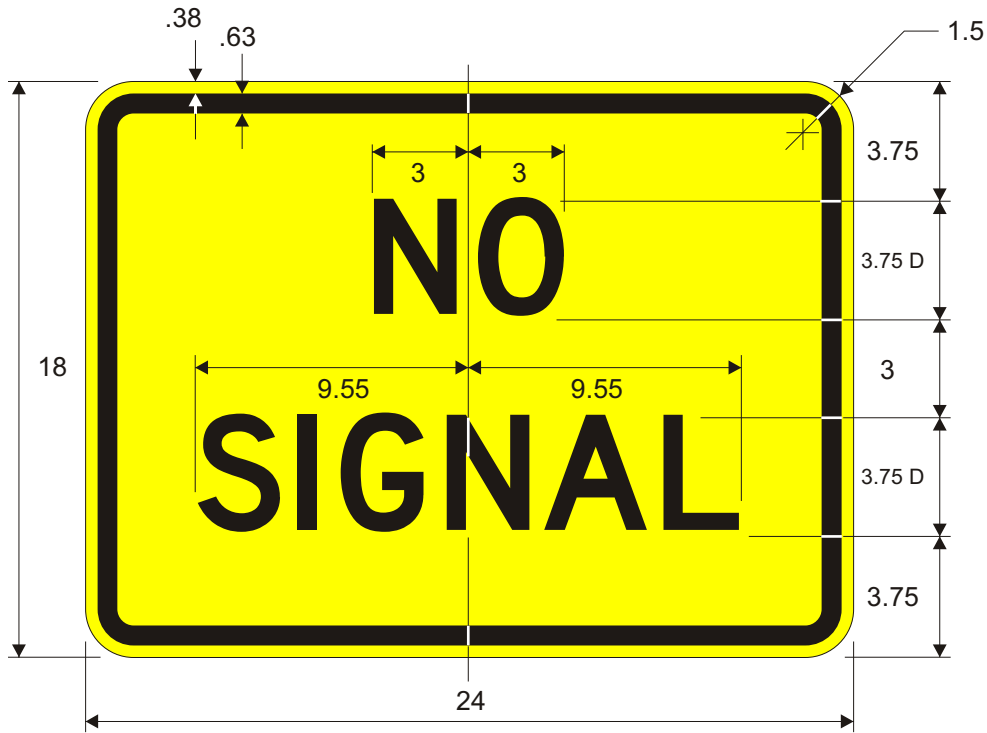

W10-10

Border and Legend: Black
Background: Yellow

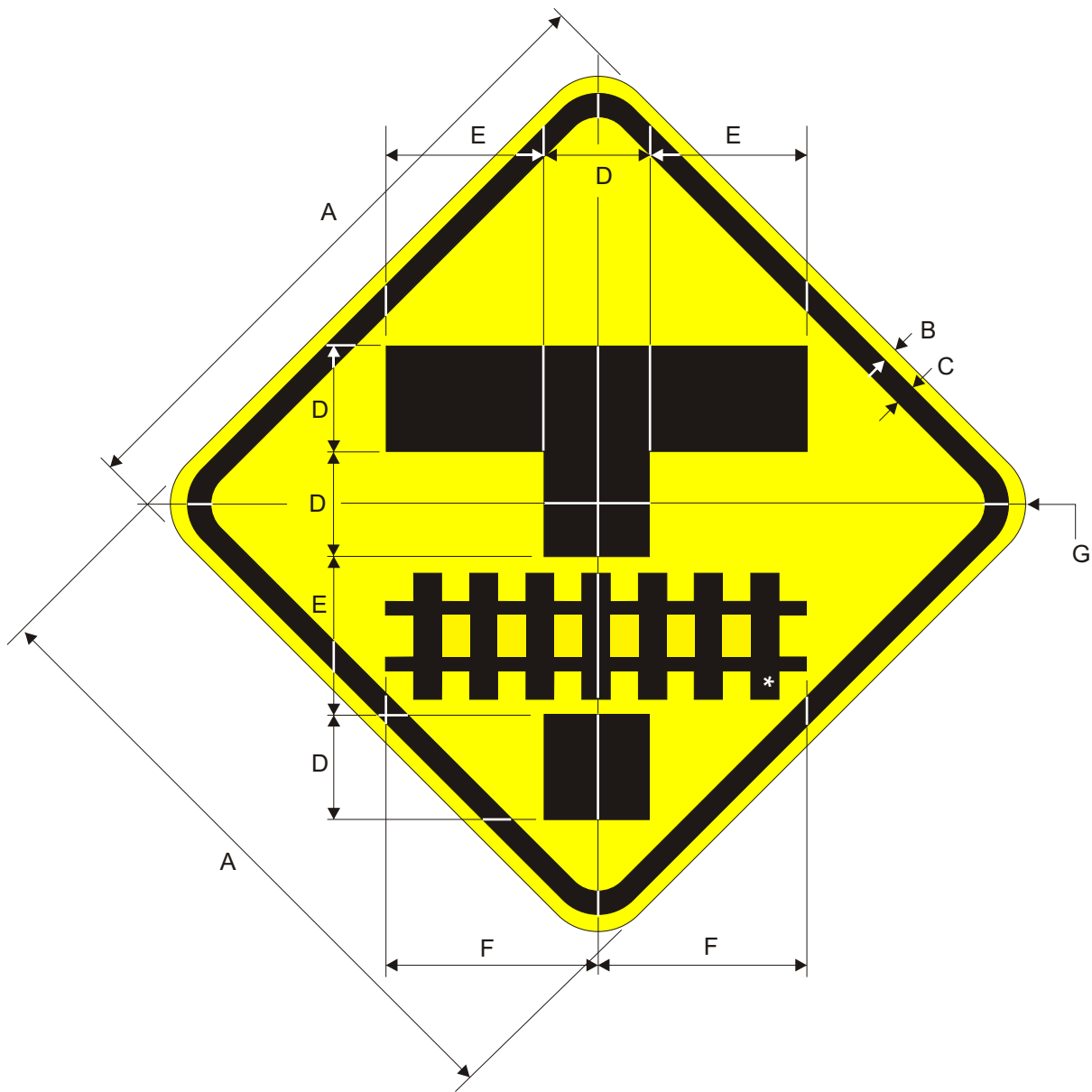

Border and Legend: Black
Background: Yellow

Road Class	Dimensions (inches)						
	A	B	C	D	E	F	G
Min.	30	0.5	0.75	5.0	7.49	10	1.88
Conv.	36	0.63	0.88	6.0	9.0	12	2.25
Expy	48	0.75	1.25	8.0	12	16	3.0

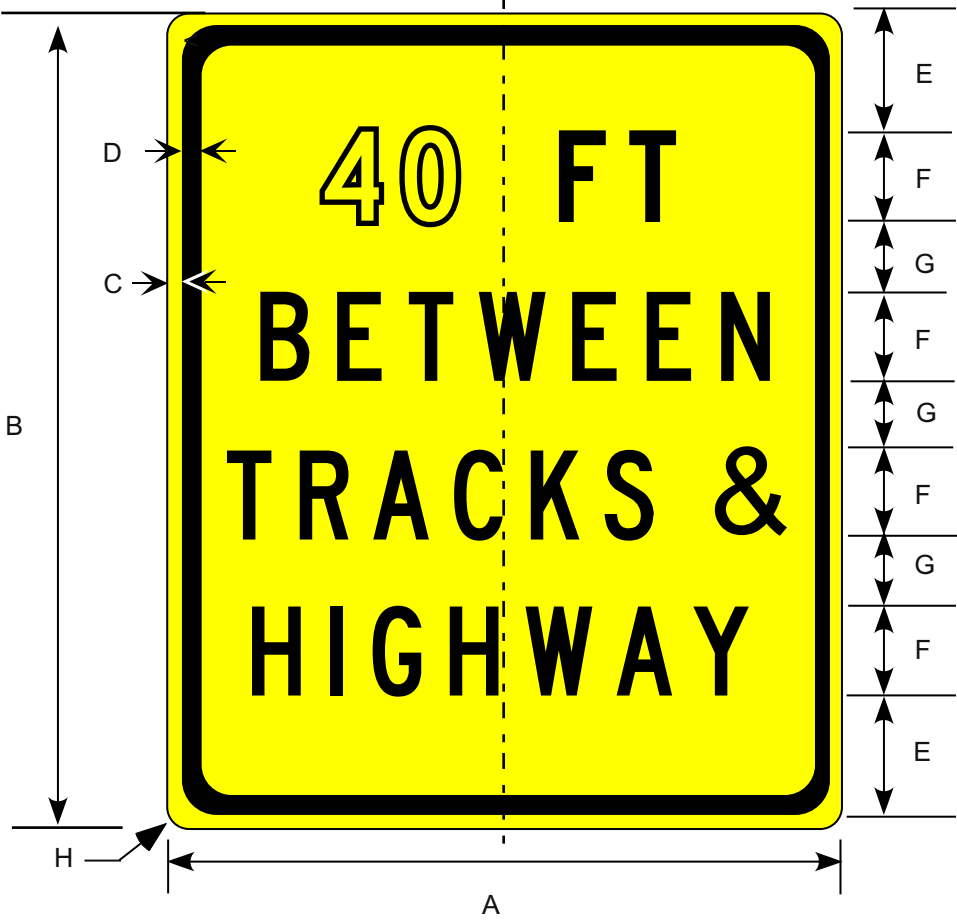

Border and Legend: Black
 Background: Yellow

Road Class	Dimensions (inches)							
	A	B	C	D	E	F	G	H
Conv & Min	30	36	0.50	0.75	5.13	4C	3.25	1.88

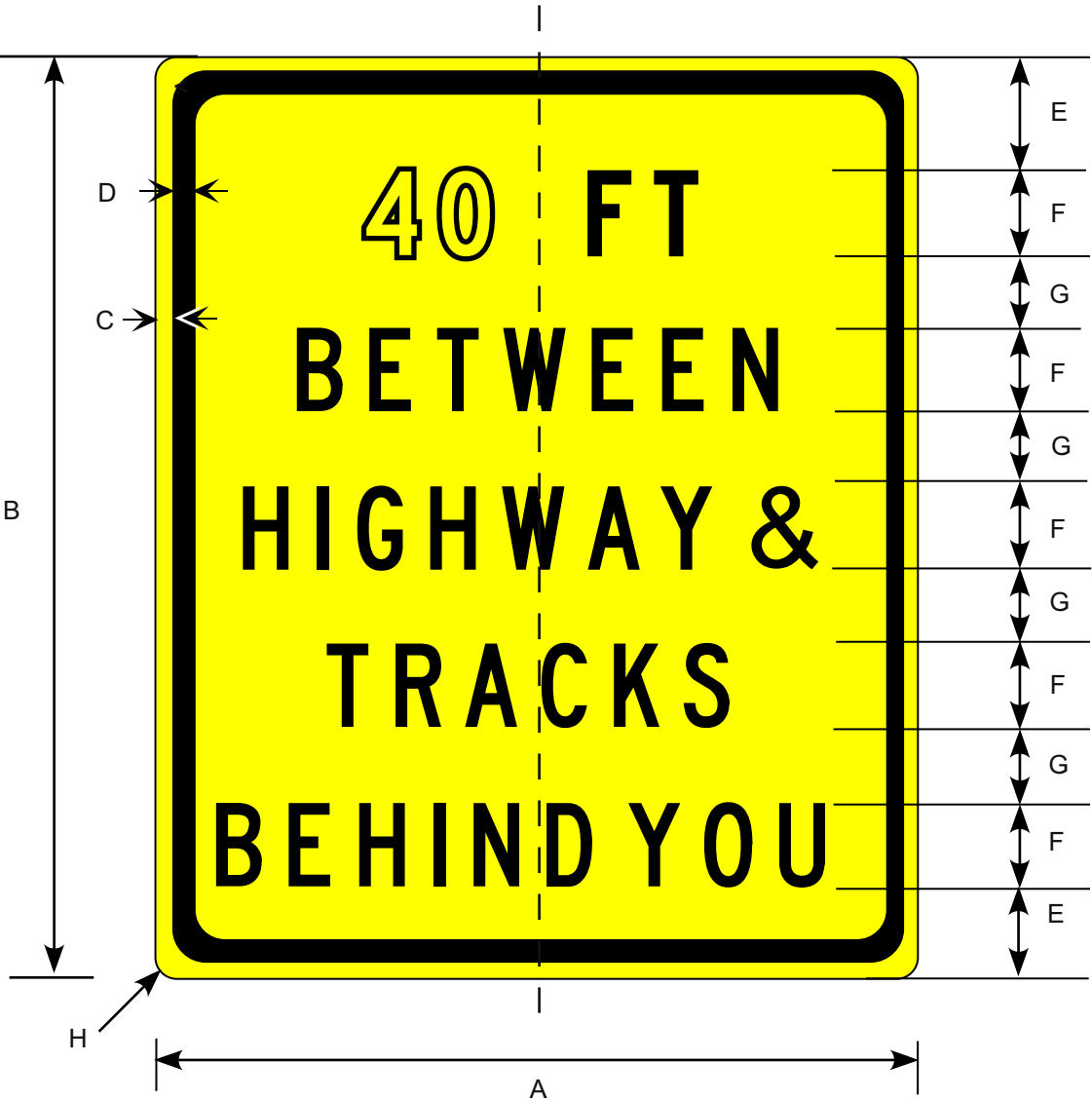

Border and Legend: Black
 Background: Yellow

Road Class	Dimensions (inches)							
	A	B	C	D	E	F	G	H
Conv & Min	36	42	0.63	0.88	4.5	4C	3.25	2.25

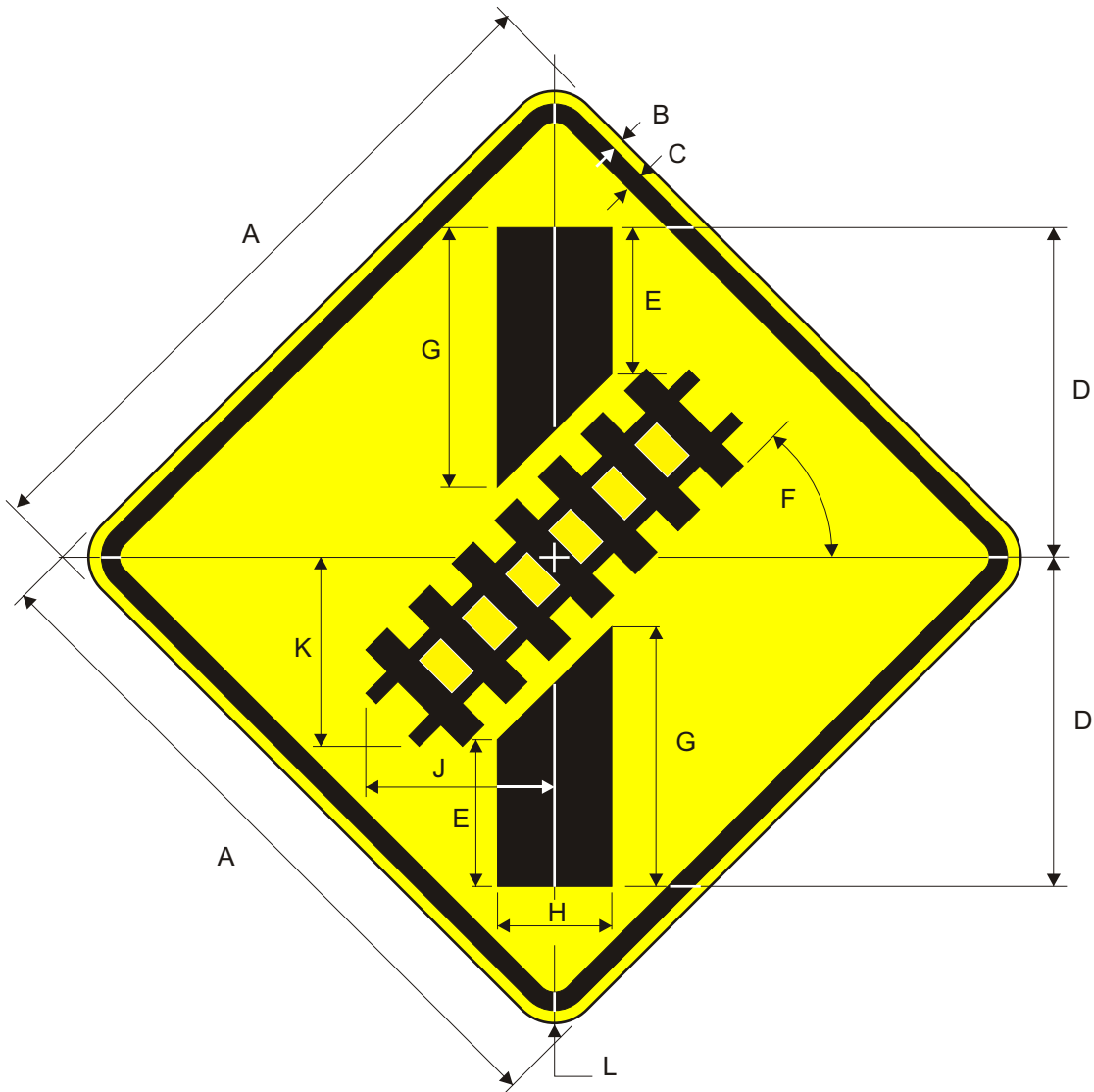

Border and Legend: Black
Background : Yellow

Road Class	Dimensions (inches)										
	A	B	C	D	E	F	G	H	J	K	L
Min.	30	0.5	0.75	14.41	6.36	45°	11.37	5.0	8.21	8.29	1.88
Conv.	36	0.63	0.88	17.29	7.65	45°	13.65	6.0	9.85	9.93	2.25
Expy	48	0.75	1.25	23.06	10.17	45°	18.17	8.0	13.13	13.25	3.0

W10-13

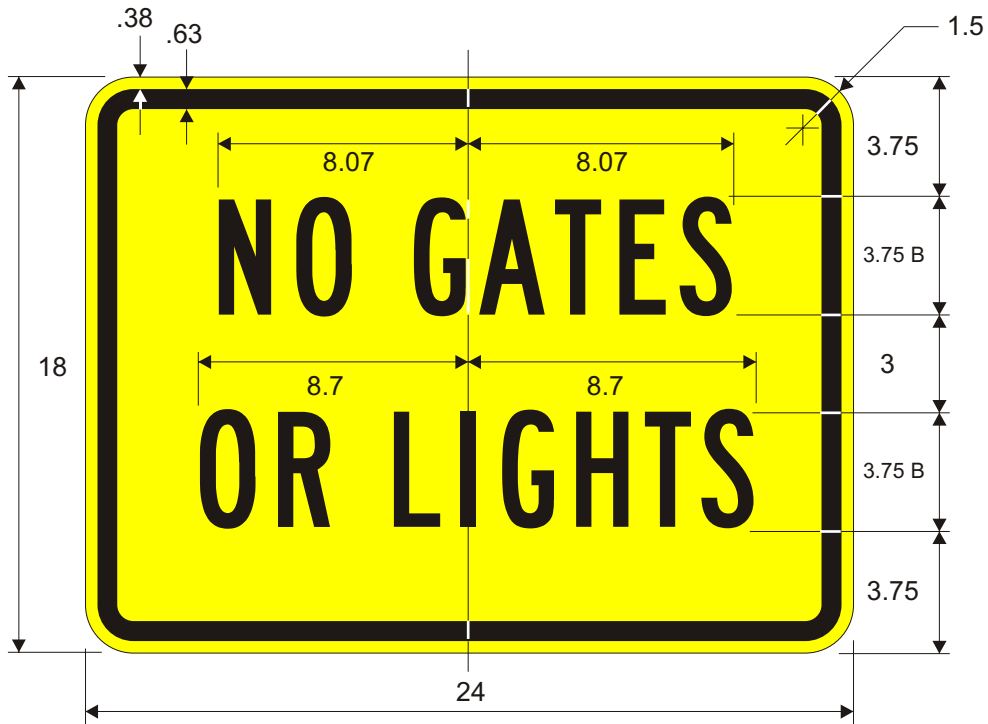

Sign Shall Only be Used With W10-1

Border and Legend: Black
Background : Yellow

W10-14
W10-14A

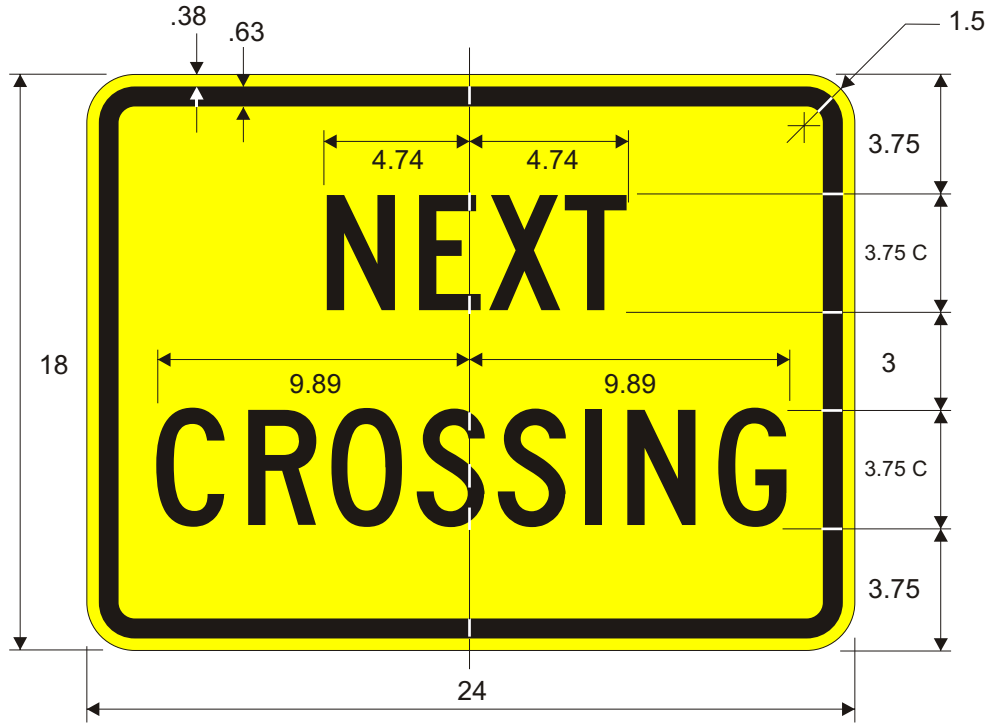

W10-14

For Use With W10-5

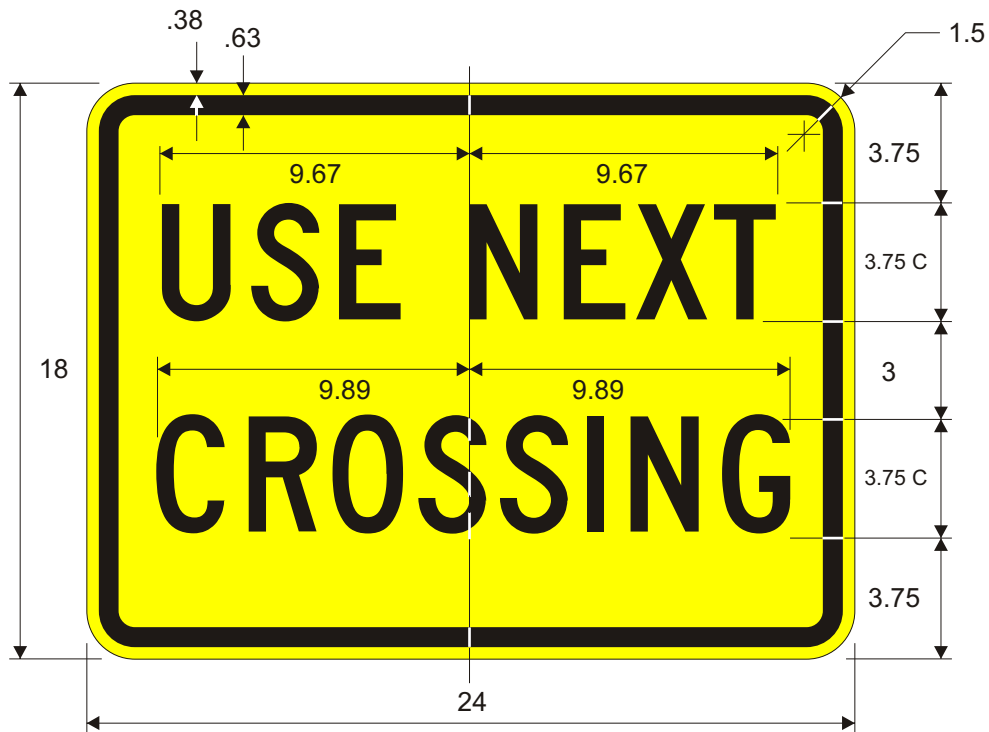

W10-14A

Border and Legend: Black
Background : Yellow

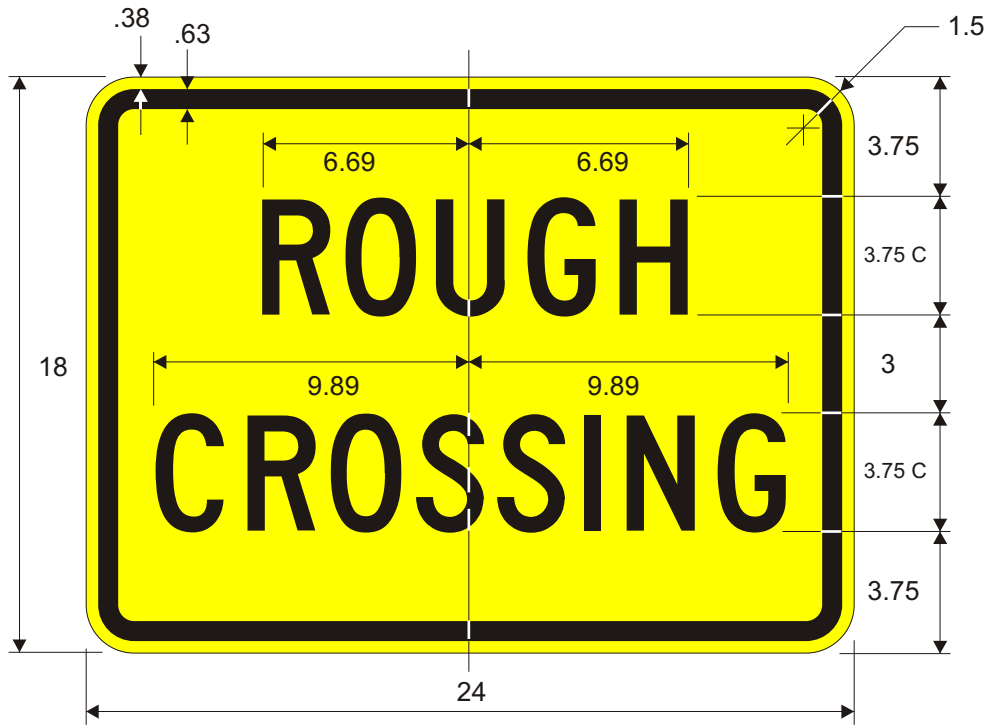

Border and Legend: Black
Background : Yellow

W10-100

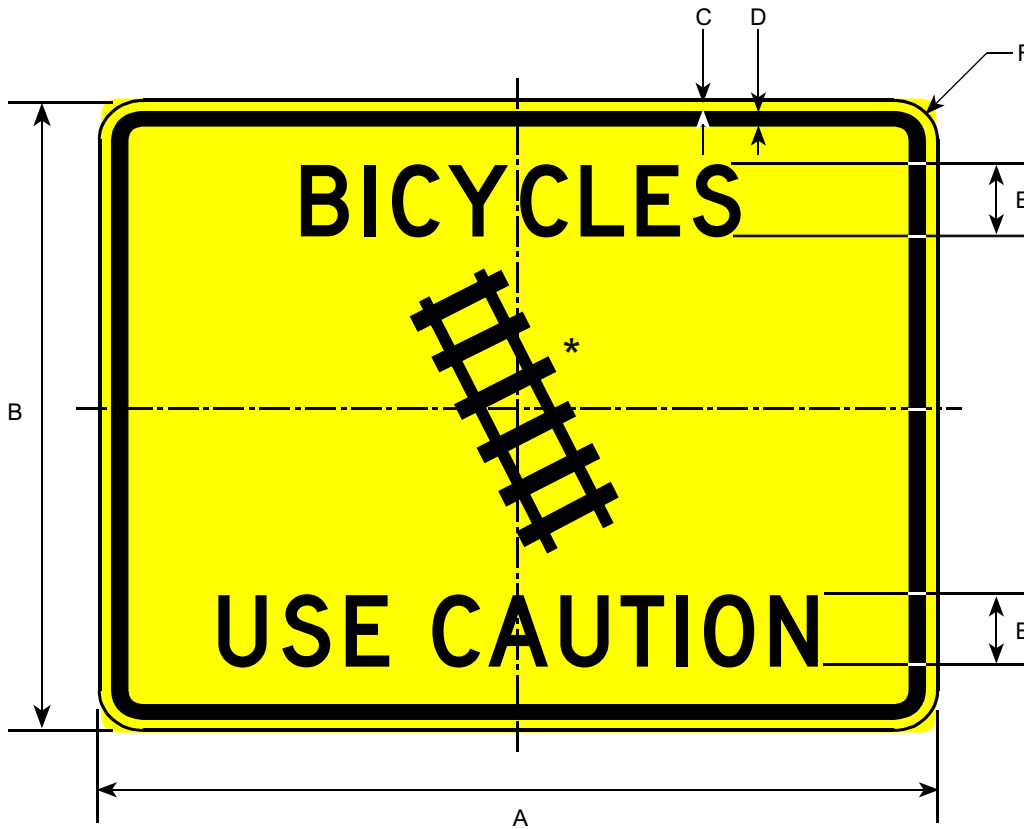

*Make symbol proportional to the graphic shown.

Border and Legend: Black
Background: Yellow

Prior to the 2002 publication of this manual, this sign was numbered W10-5A.

Road Class	Dimensions (inches)					
	A	B	C	D	E	F
Conventional	24	18	0.38	0.63	2D	1.5

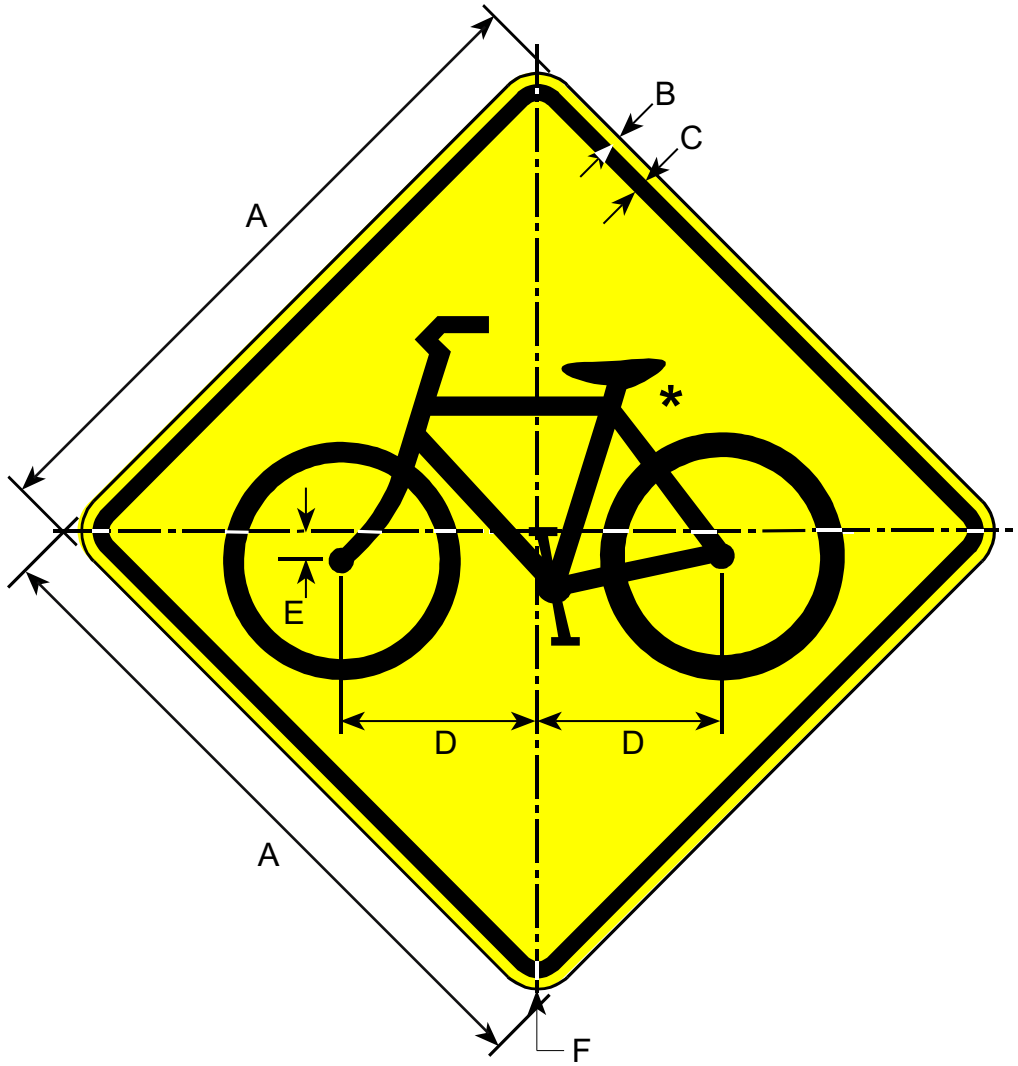

*Make symbol proportional to the graphic shown.

Border and Legend: Black
Background: Yellow

Road Class	Dimensions (inches)					
	A	B	C	D	E	F
Bike	24	0.38	0.63	6.69	0.81	1.50
Minimum	30	0.50	0.75	8.50	1.00	1.88
Conventional	36	0.63	0.88	10.00	1.19	2.25
Expwy	48	0.75	1.25	13.38	1.63	3.00

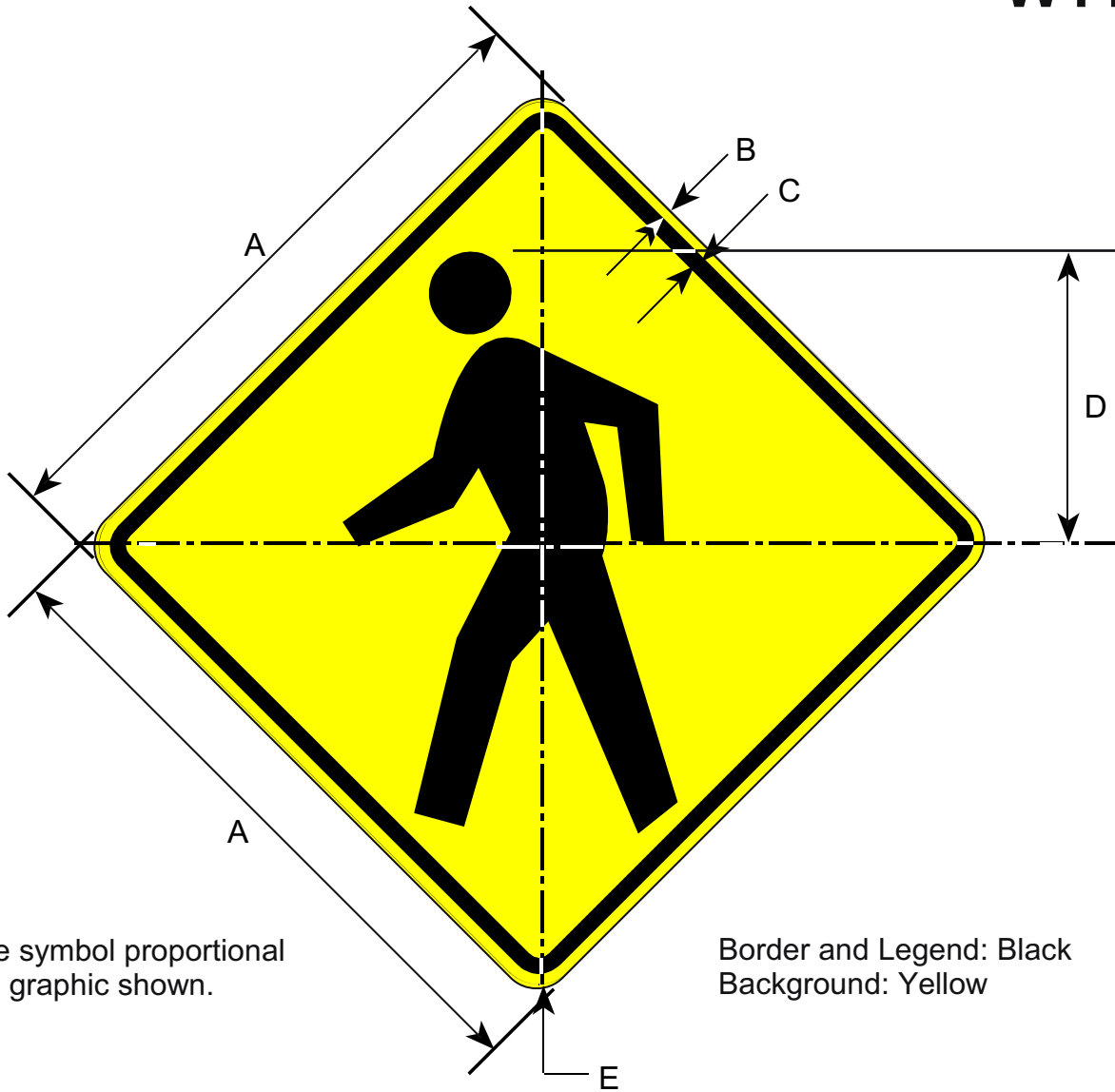

Pedestrian crossing signs used to mark a crossing location shall be supplemented with diagonal downward pointing arrow W16-7P.

Road Class	Dimensions (inches)				
	A	B	C	D	E
Minimum	30	0.50	0.75	14	1.88
Conventional	36	0.63	0.88	16.75	2.25
Expressway	48	0.75	1.25	22	3.0

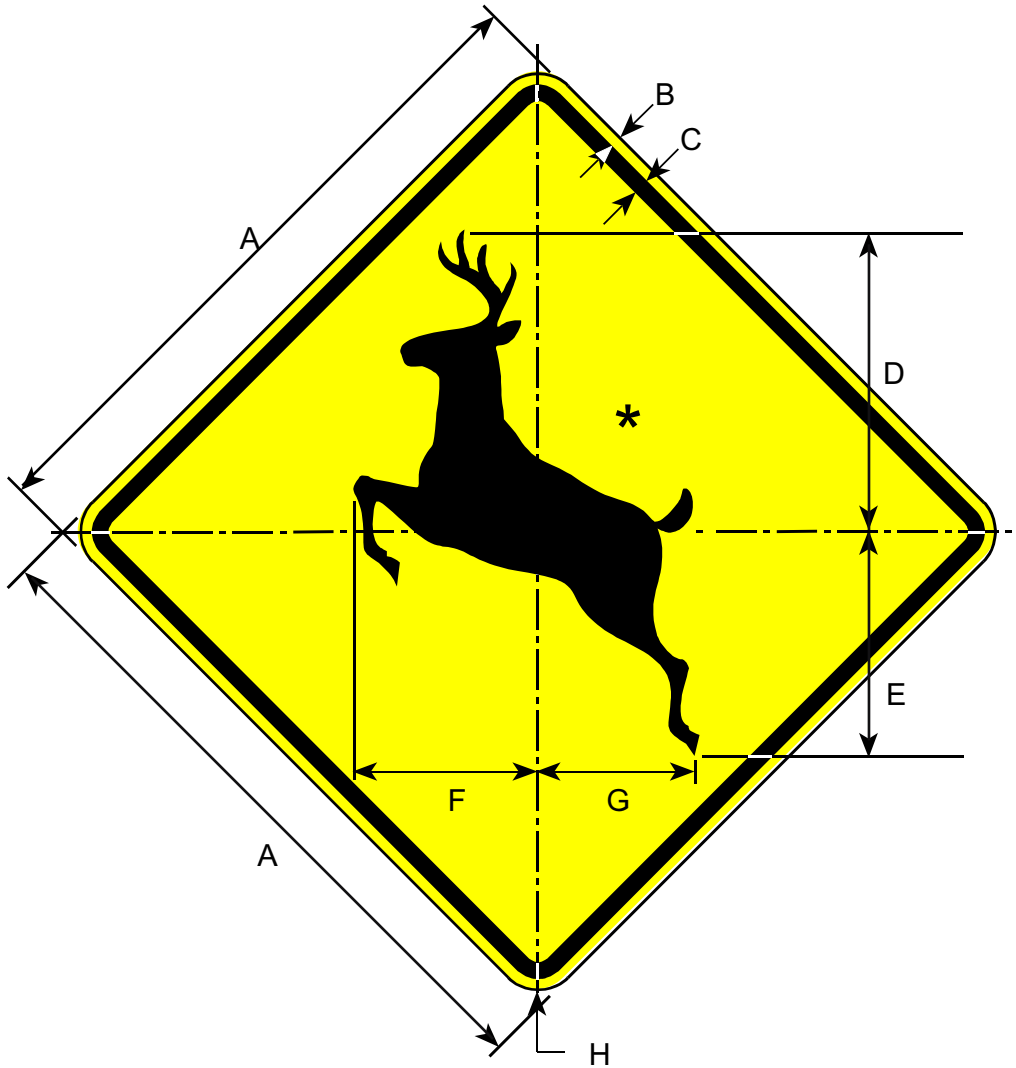

*Make symbol proportional to the graphic shown.

Border and Legend: Black
Background: Yellow

Road Class	Dimensions (inches)							
	A	B	C	D	E	F	G	H
Minimum	30	0.50	0.75	13.50	10.00	7.50	7.50	1.88
Conventional	36	0.63	0.88	16.25	12.00	9.88	9.00	2.25
Expwy/Fwy	48	0.75	1.25	21.25	15.75	13.00	11.75	3.00

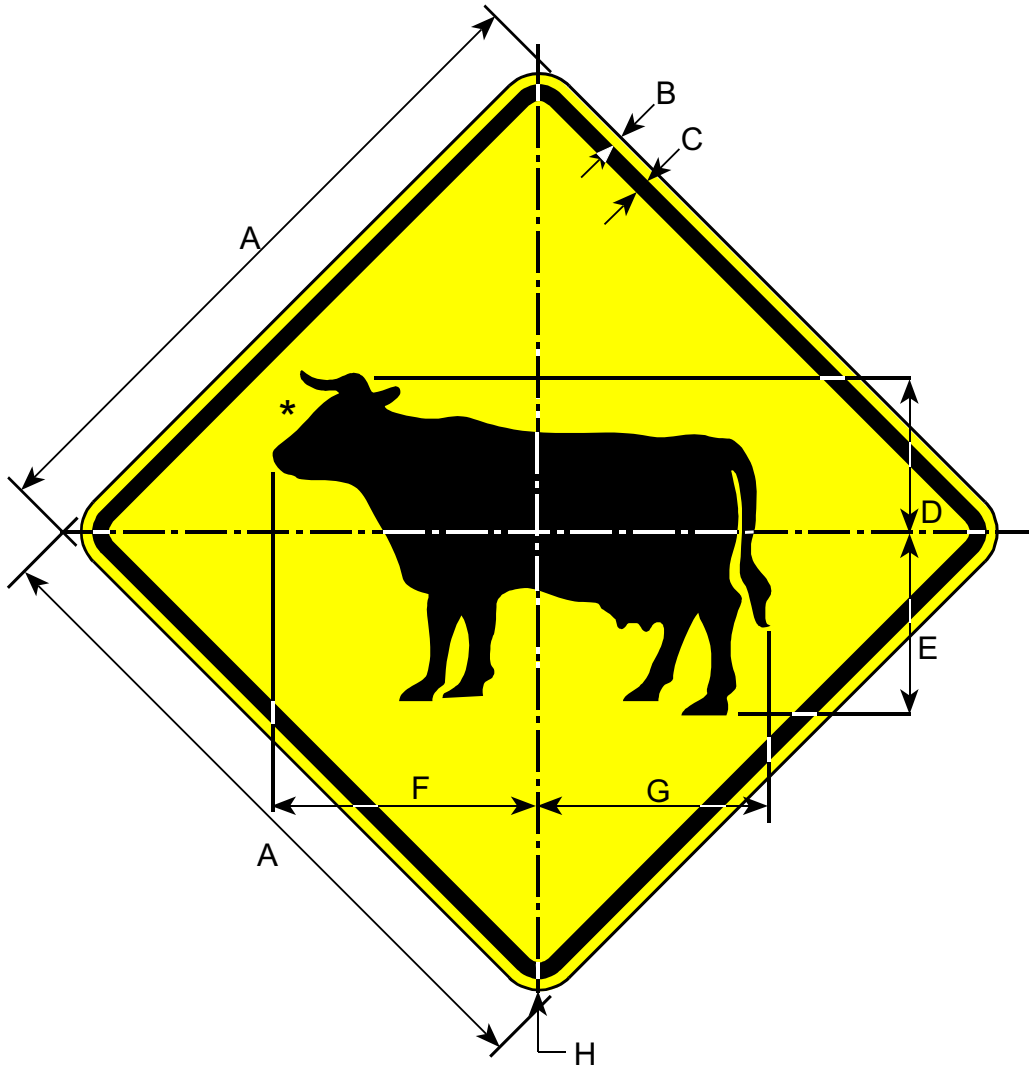

*Make symbol proportional to the graphic shown.

Border and Legend: Black
Background: Yellow

Road Class	Dimensions (inches)							
	A	B	C	D	E	F	G	H
Minimum	30	0.50	0.75	6.00	8.00	11.00	10.50	1.88
Conventional	36	0.63	0.88	7.25	9.63	14.13	12.63	2.25
Expwy/Fwy	48	0.75	1.25	9.50	12.63	18.50	16.63	3.00

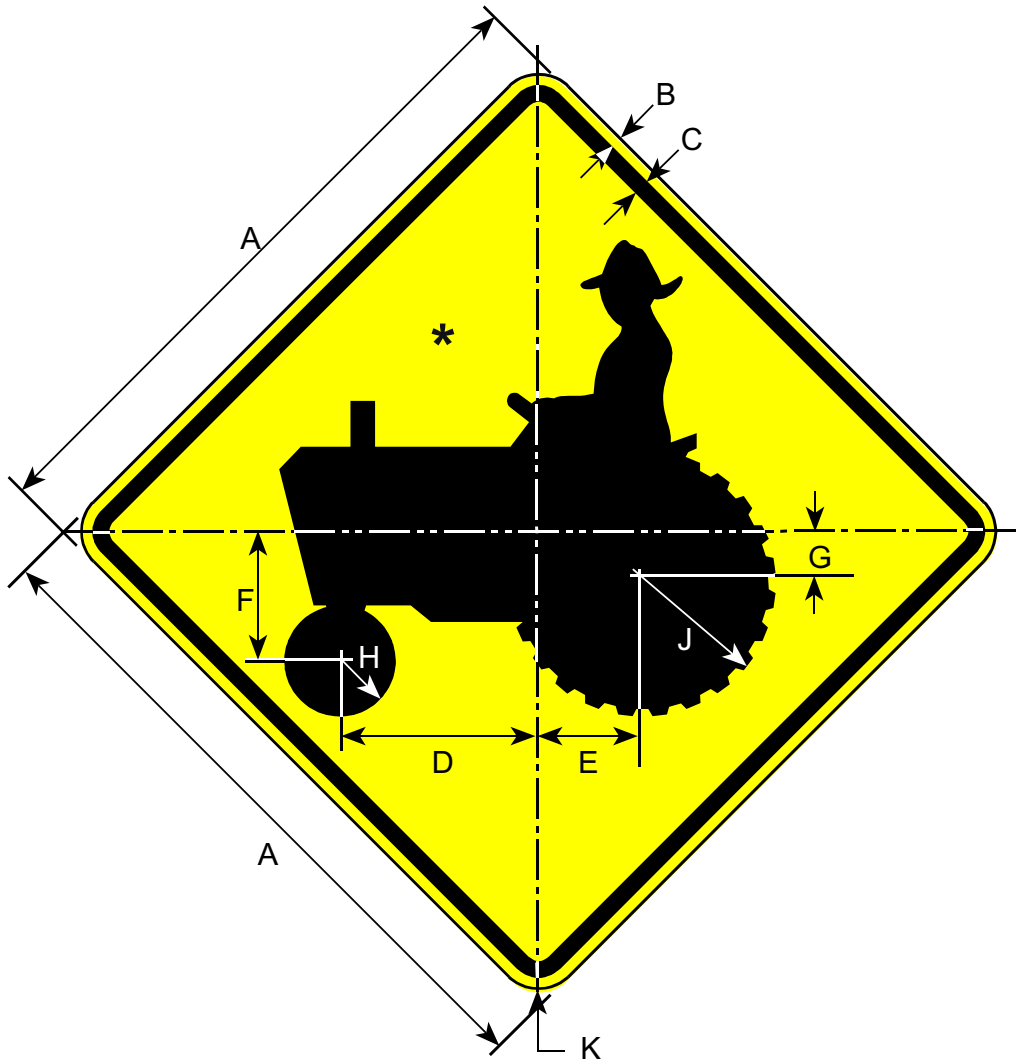

*Make symbol proportional to the graphic shown.

Border and Legend: Black
Background: Yellow

Road Class	Dimensions (inches)									
	A	B	C	D	E	F	G	H	J	K
Minimum	30	0.50	0.75	8.63	4.75	5.50	1.75	2.5	6.00	1.88
Conventional	36	0.63	0.88	10.50	5.75	6.63	2.13	3.0	7.25	2.25
Expwy/Fwy	48	0.75	1.25	13.75	7.50	8.75	2.75	4.0	9.50	3.00

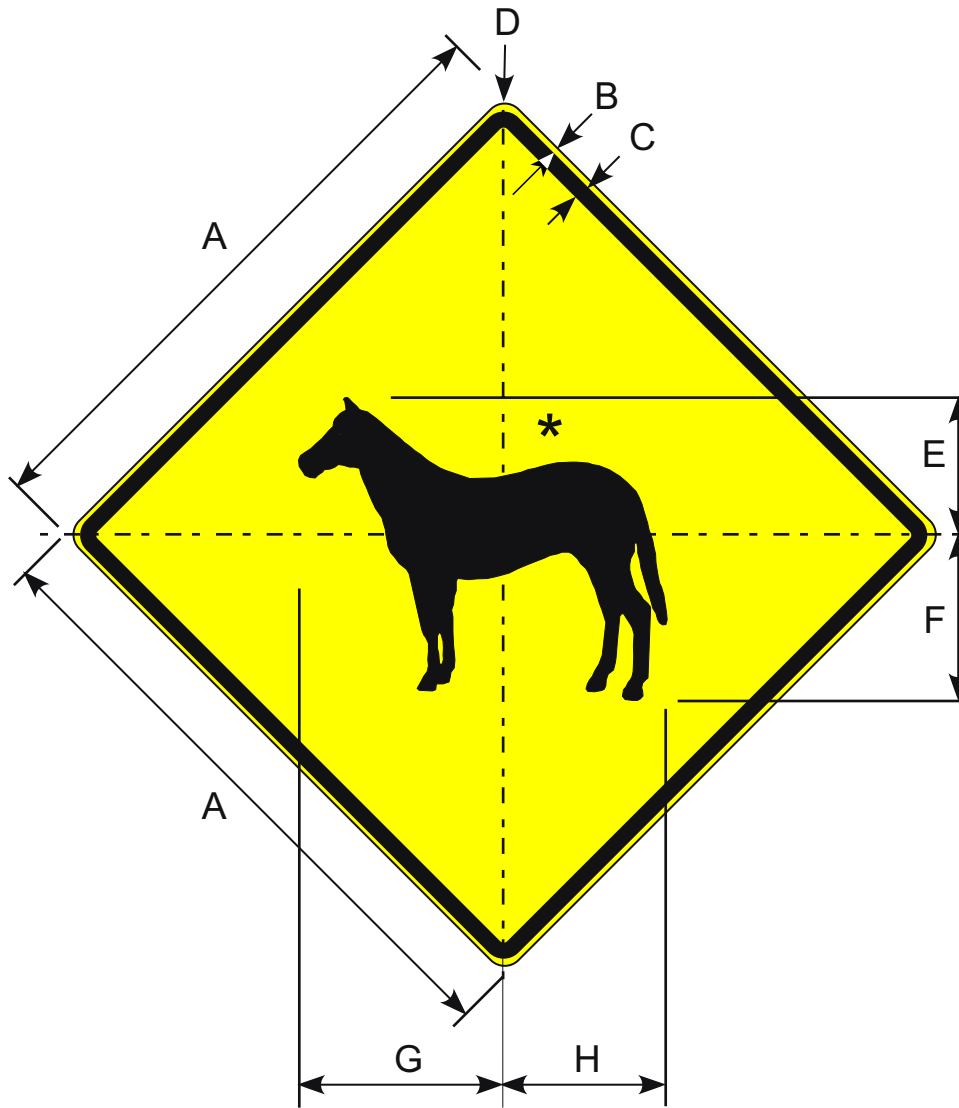

*Make symbol proportional to the graphic shown.

Border and Legend: Black
Background: Yellow

Prior to the 2002 publication of this manual, this sign was numbered W11-11.

Road Class	Dimensions (inches)							
	A	B	C	D	E	F	G	H
Minimum	30	0.50	0.75	1.88	6.63	8.00	9.06	7.88
Conventional	36	0.63	0.88	2.25	7.94	9.63	11.88	9.44
Expwy/Fwy	48	0.75	1.25	3.00	10.56	12.88	15.75	12.56

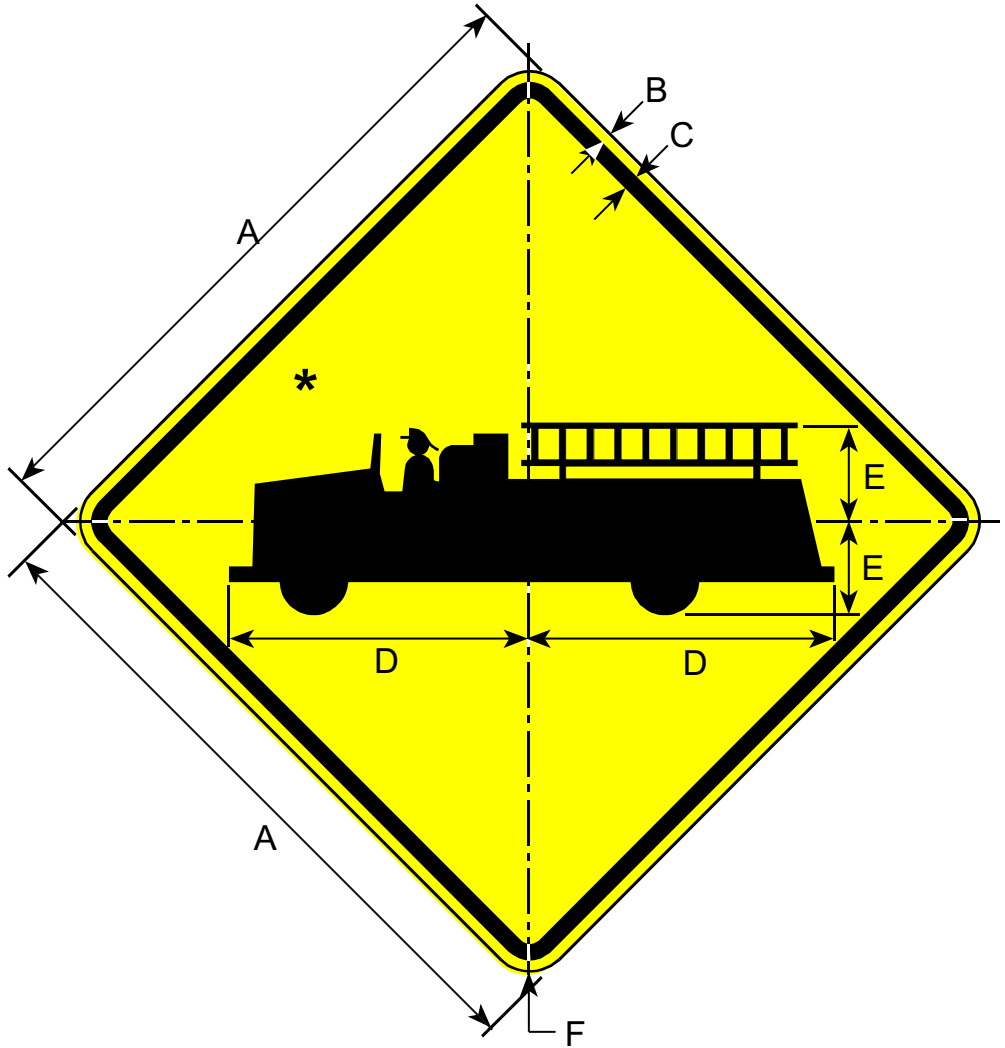

*Make symbol proportional to the graphic shown.

Border and Legend: Black
Background: Yellow

Road Class	Dimensions (inches)					
	A	B	C	D	E	F
Minimum	30	0.50	0.75	13.75	4.38	1.88
Conventional	36	0.63	0.88	16.50	5.25	2.25
Expwy/Fwy	48	0.75	1.25	22.00	7.00	3.00

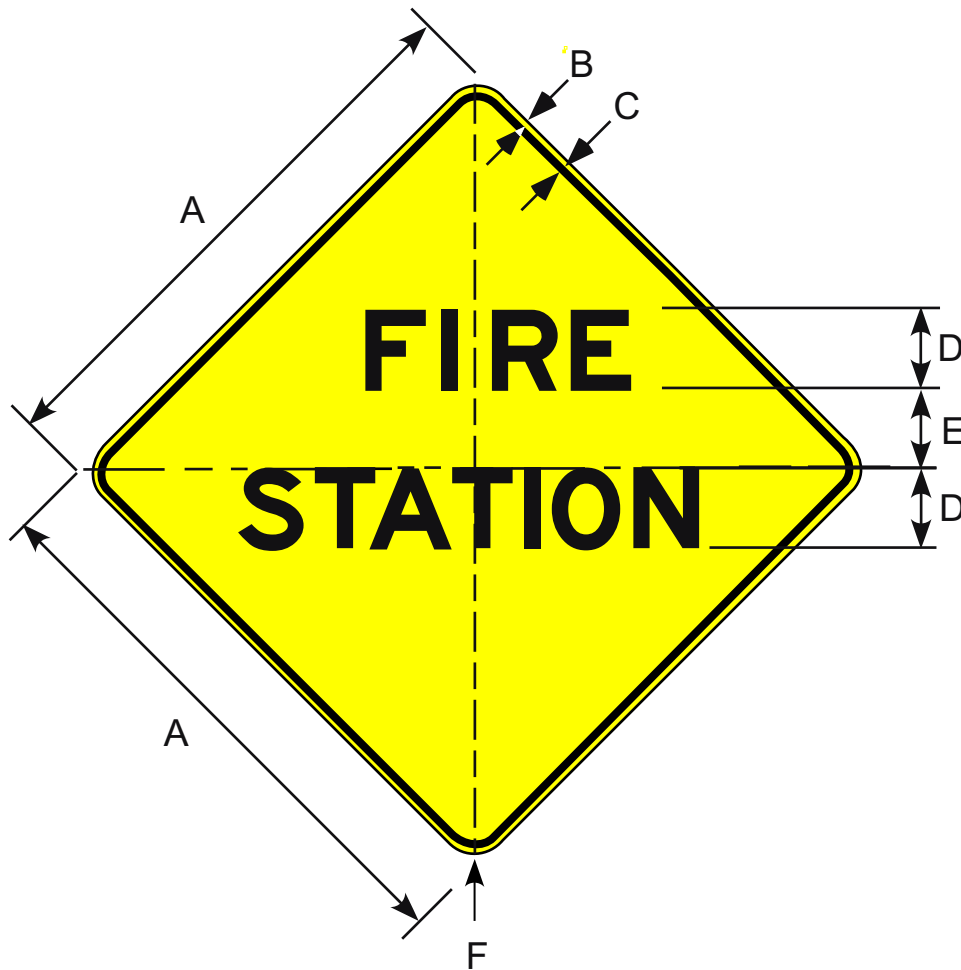

Border and Legend: Black
Background: Yellow

Road Class	Dimensions (inches)					
	A	B	C	D	E	F
Minimum	30	0.50	0.75	5E	5	1.88
Conventional	36	0.63	0.88	6E	6	2.25
Expwy/Fwy	48	0.75	1.25	8E	8	2.25

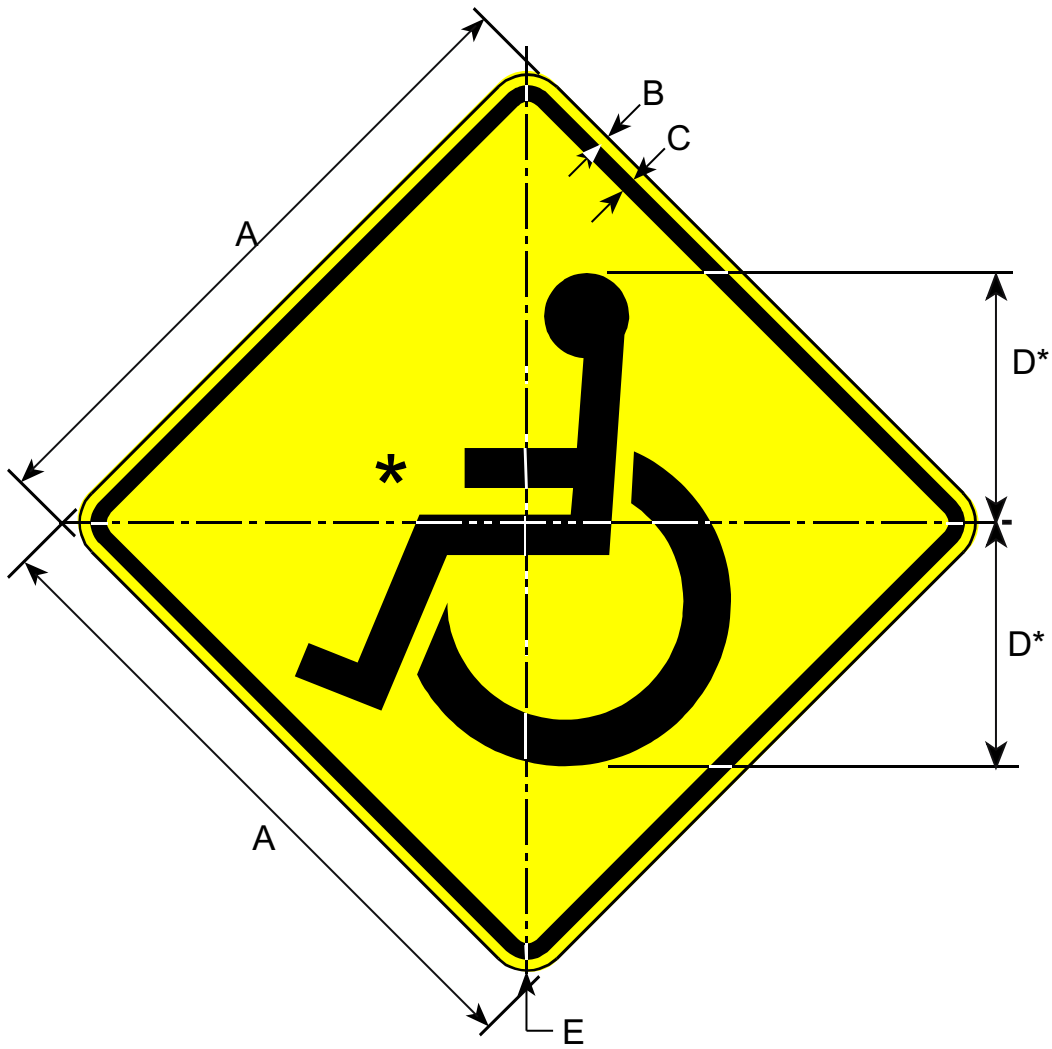

*Make symbol proportional to the graphic shown.

Border and Legend: Black
Background: Yellow

Road Class	Dimensions (inches)				
	A	B	C	D	E
Minimum	30	0.50	0.75	11.25	1.88
Conventional	36	0.63	0.88	13.50	2.25
Expwy/Fwy	48	0.75	1.25	18.00	3.00

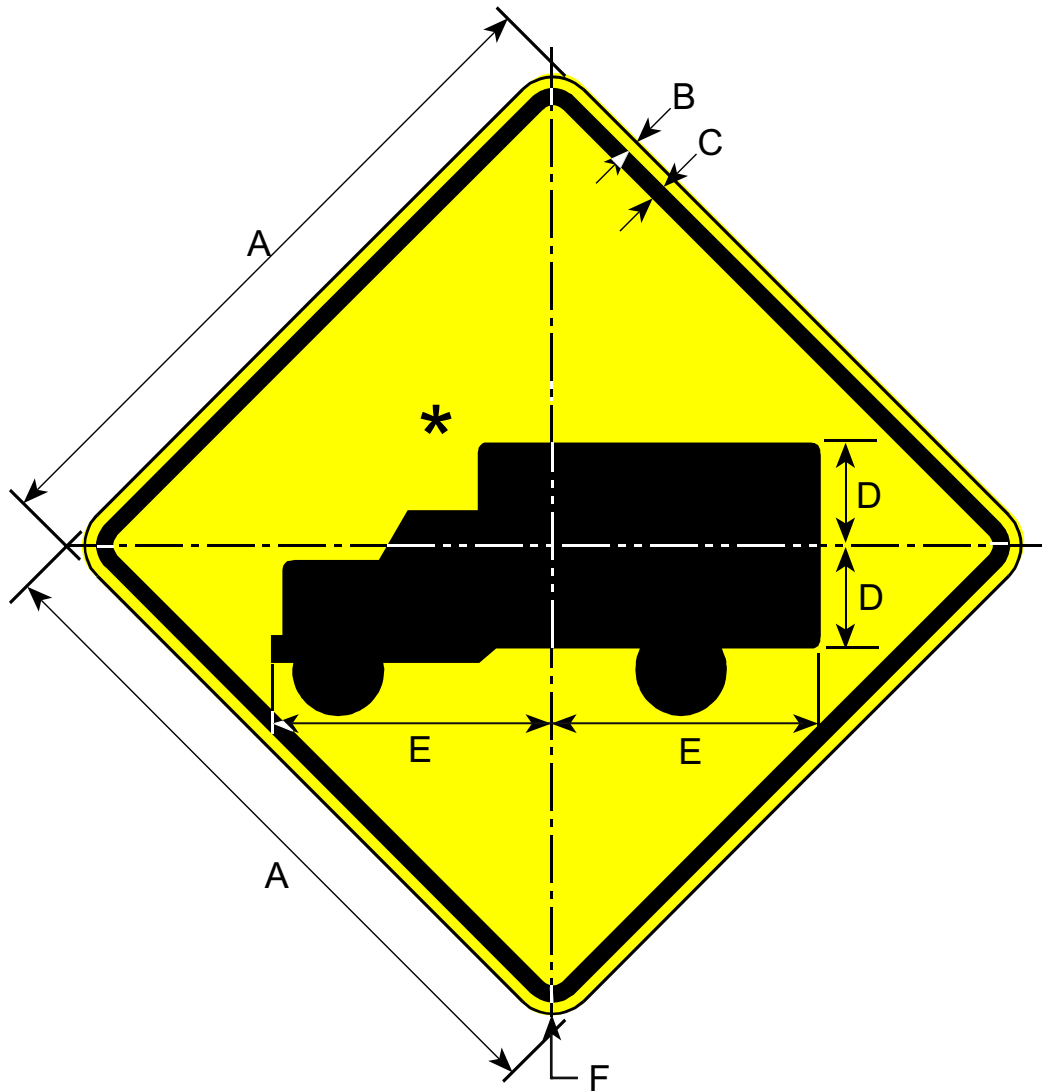

*Make symbol proportional to the graphic shown.

Border and Legend: Black
Background: Yellow

Road Class	Dimensions (inches)					
	A	B	C	D	E	F
Minimum	30	0.50	0.75	9	12	1.88
Conventional	36	0.63	0.88	10	14	2.25
Expwy/Fwy	48	0.75	1.25	14	19	3.00

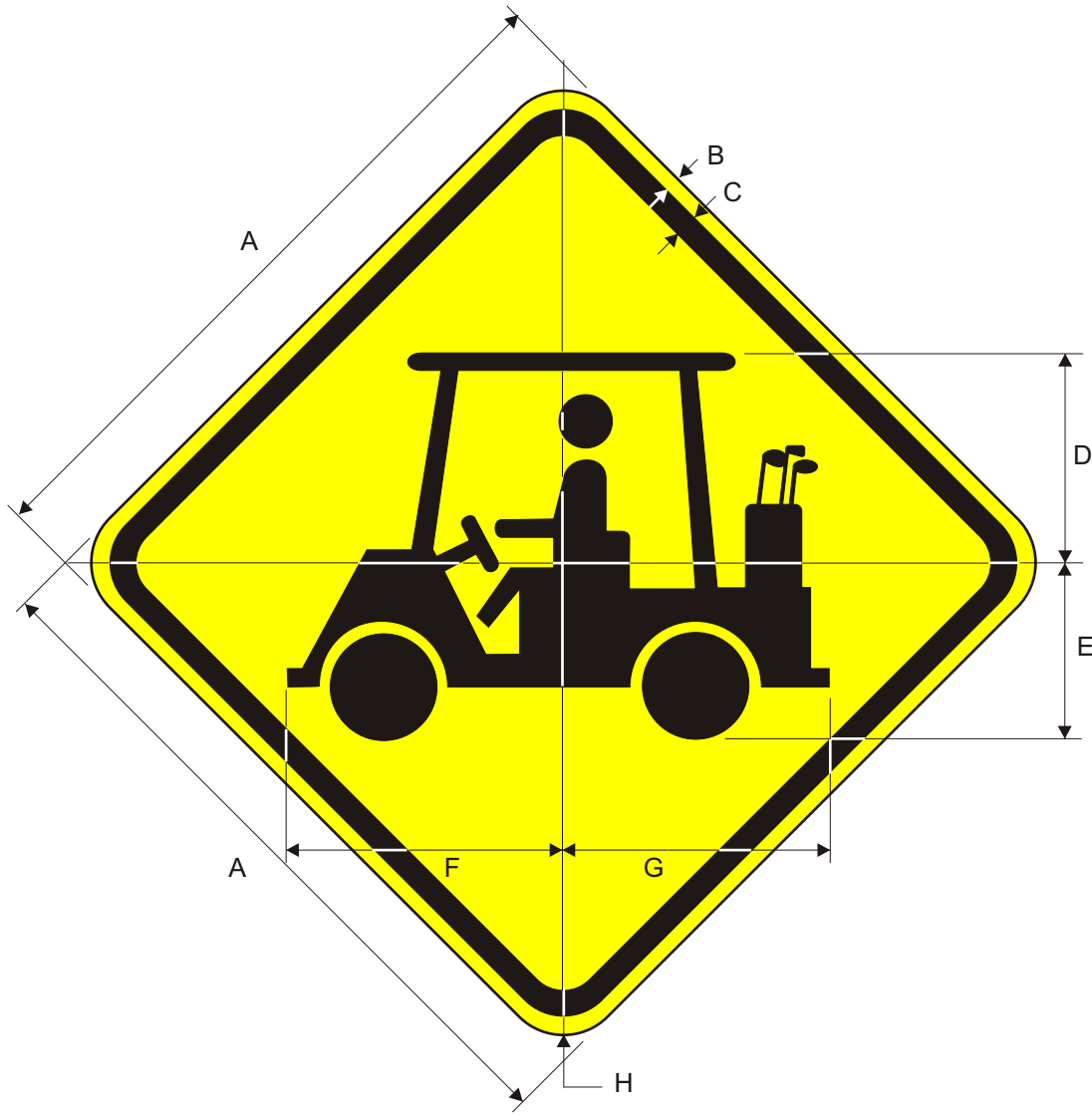

Border and Legend: Black
Background: Yellow

Road Class	Dimensions (inches)							
	A	B	C	D	E	F	G	H
Min.	30	0.50	0.75	9.13	7.61	11.89	11.45	1.88
Conv.	36	0.63	0.88	10.93	9.13	14.25	13.73	2.25
Expy	48	0.75	1.25	14.57	12.13	18.93	18.25	3.0

W11-12P

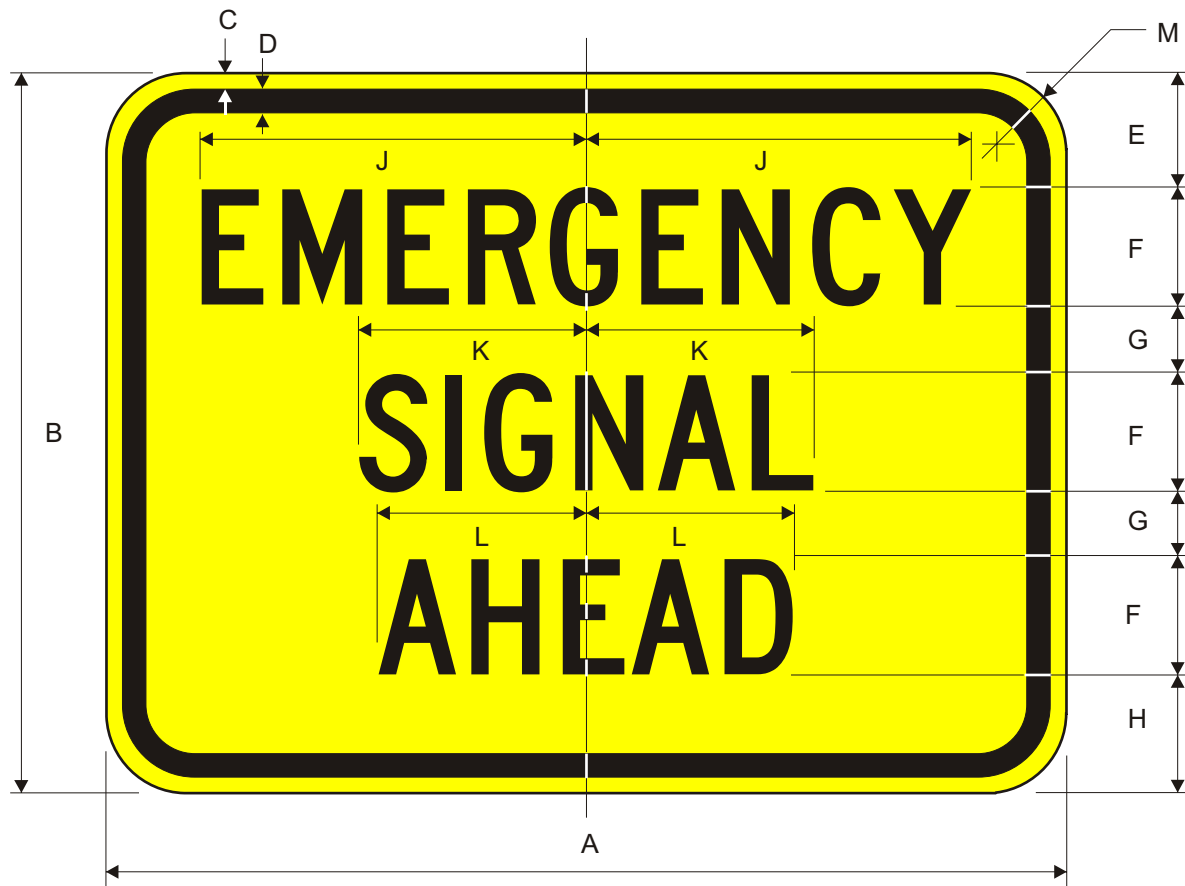

For Use With W11-8 "EMERGENCY VEHICLE"

Border and Legend: Black
Background: Yellow

Road Class	Dimensions (inches)											
	A	B	C	D	E	F	G	H	J	K	L	M
Min.	30	24	0.50	0.75	4.0	4C	2.0	4.0	12.89	7.61	6.99	1.88
Conv.	36	30	0.63	0.88	5.63	4.25C	3	5.63	14.19	8.37	7.67	2.25

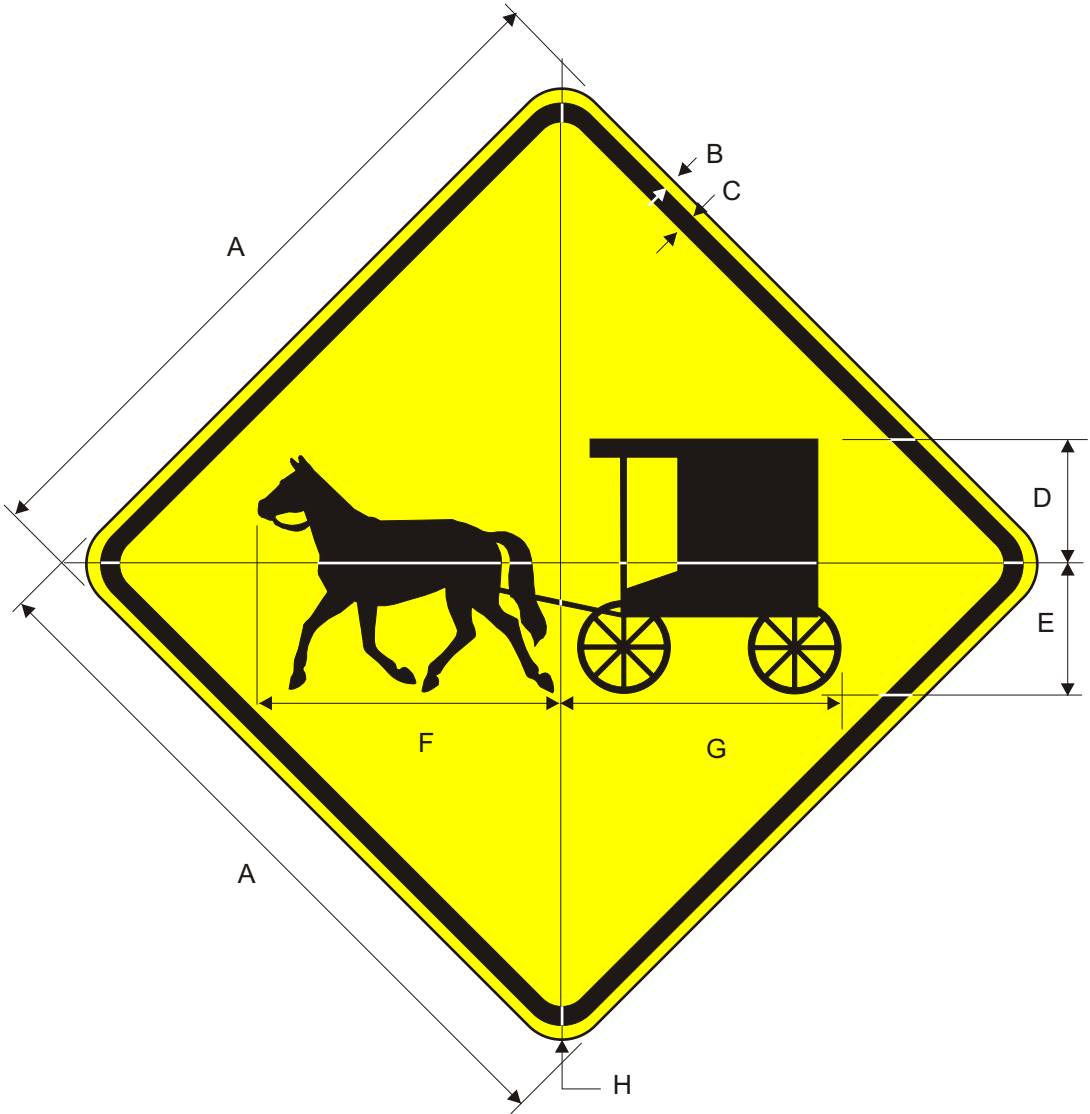

Border and Legend: Black
Background: Yellow

Road Class	Dimensions (inches)							
	A	B	C	D	E	F	G	H
Min.	30	0.50	0.75	5.40	5.56	13	11.97	1.88
Conv.	36	0.63	0.88	6.48	6.69	15.61	14.37	2.25
Expy.	48	0.75	1.25	8.65	8.93	20.82	19.17	3.0

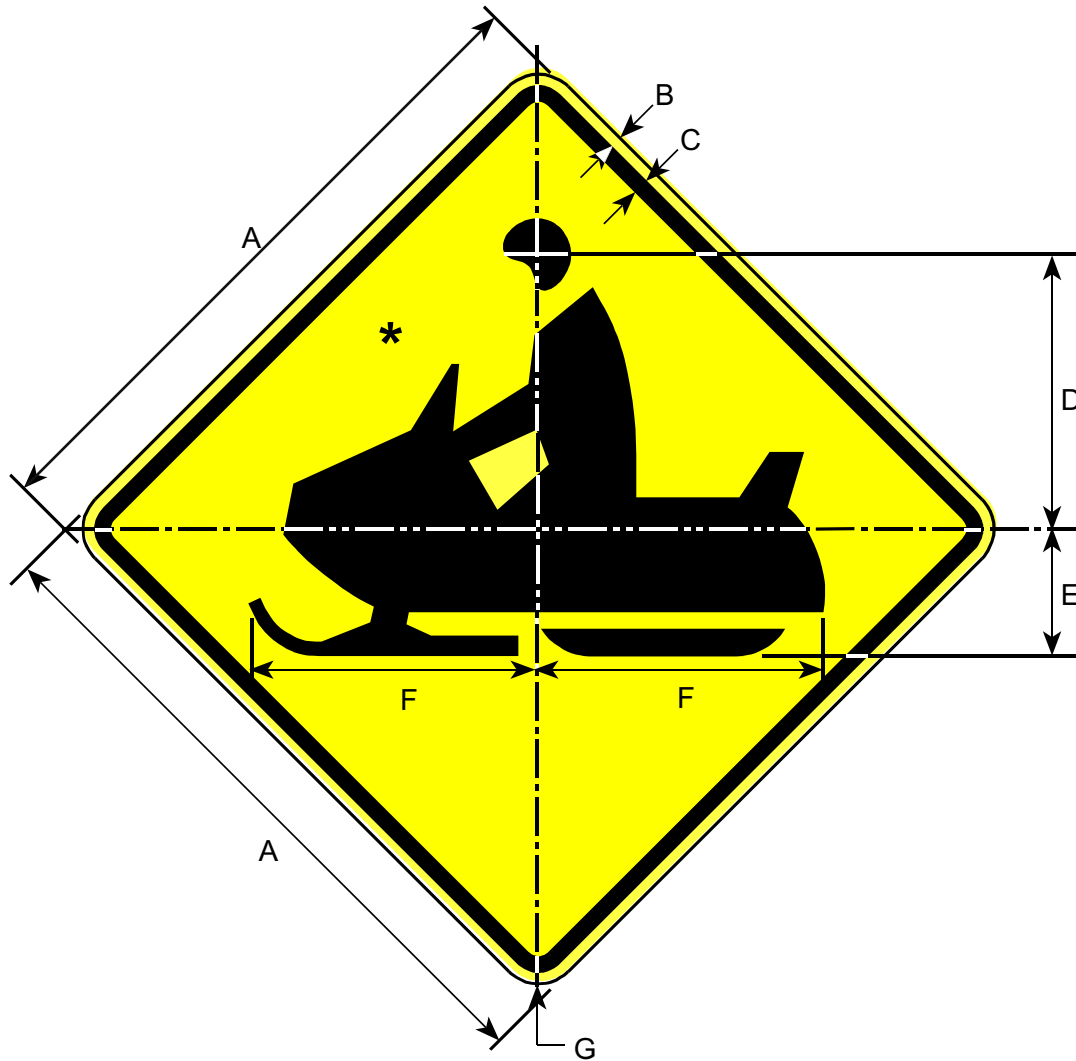

*Make symbol proportional to the graphic shown.

Border and Legend: Black
Background: Yellow

Prior to the 2002 publication of this manual, this sign was numbered W11-6.

Road Class	Dimensions (inches)						
	A	B	C	D	E	F	G
Minimum	30	0.50	0.75	11.75	5.56	12.75	1.88
Conventional	36	0.63	0.88	14.13	6.75	15.25	2.25

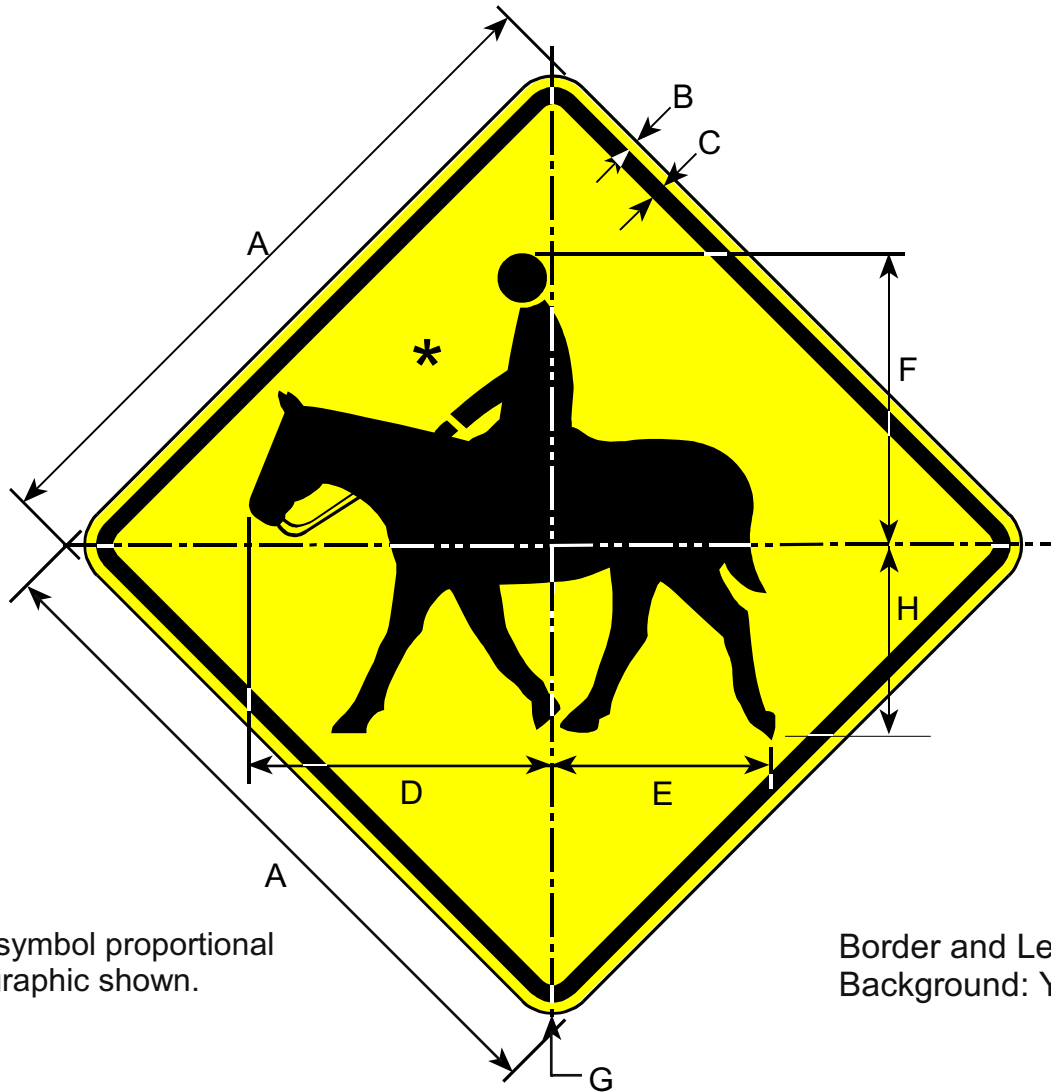

*Make symbol proportional to the graphic shown.

Border and Legend: Black
Background: Yellow

Prior to the 2002 publication of this manual, this sign was numbered W11-7.

Road Class	Dimensions (inches)							
	A	B	C	D	E	F	G	H
Minimum	30	0.50	0.75	13	10	13	1.88	8.5
Conventional	36	0.63	0.88	15.5	12	15.63	2.25	10.25
Expwy/Fwy	48	0.75	1.25	21	16	21	3	13.75

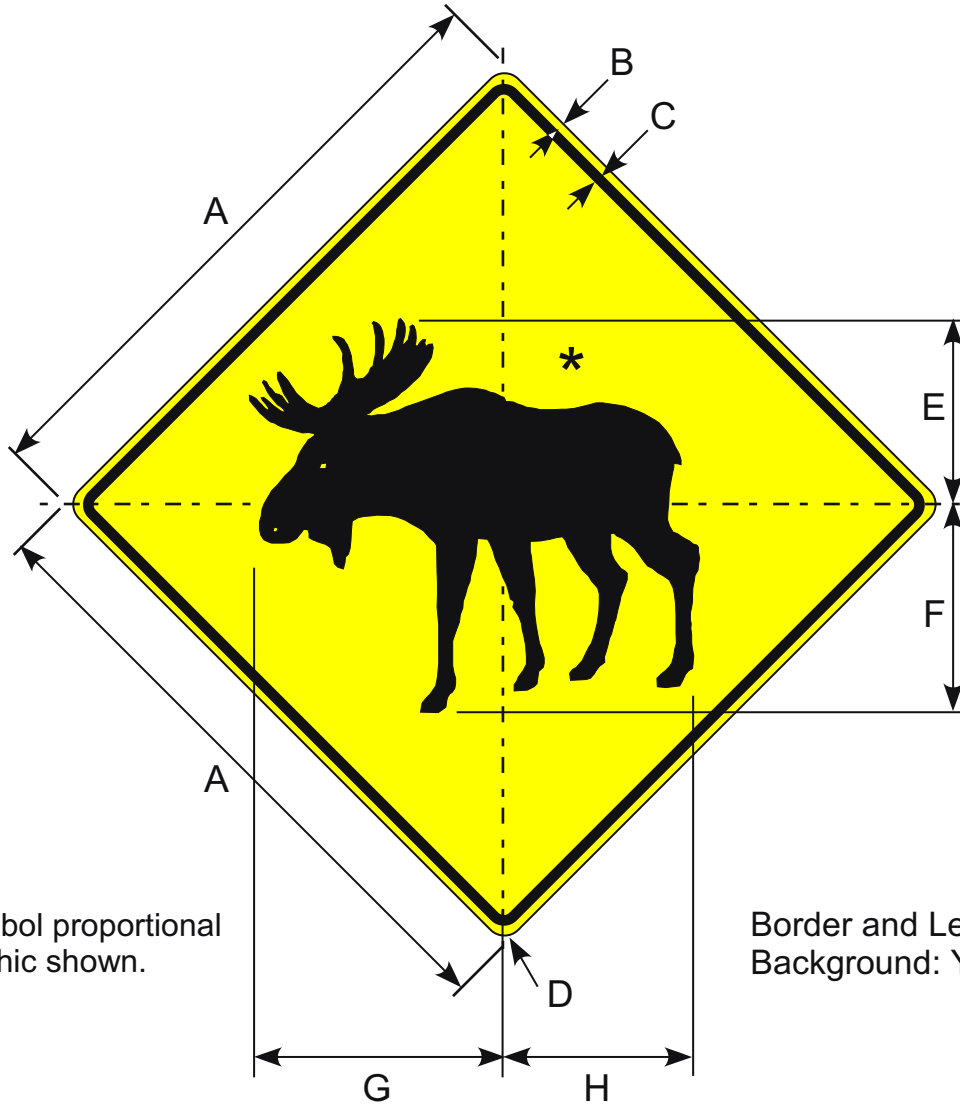

*Make symbol proportional to the graphic shown.

Border and Legend: Black
Background: Yellow

Prior to the 2002 publication of this manual, this sign was numbered W11-12.

Road Class	Dimensions (inches)								
	A	B	C	D	E	F	G	H	
Minimum	30	0.50	0.75	1.88	8.56	8.88	11.38	8.75	
Conventional	36	0.63	0.88	2.25	10.25	10.63	13.63	10.50	
Expwy/Fwy	48	0.75	1.25	3.00	13.63	14.13	18.13	14.00	

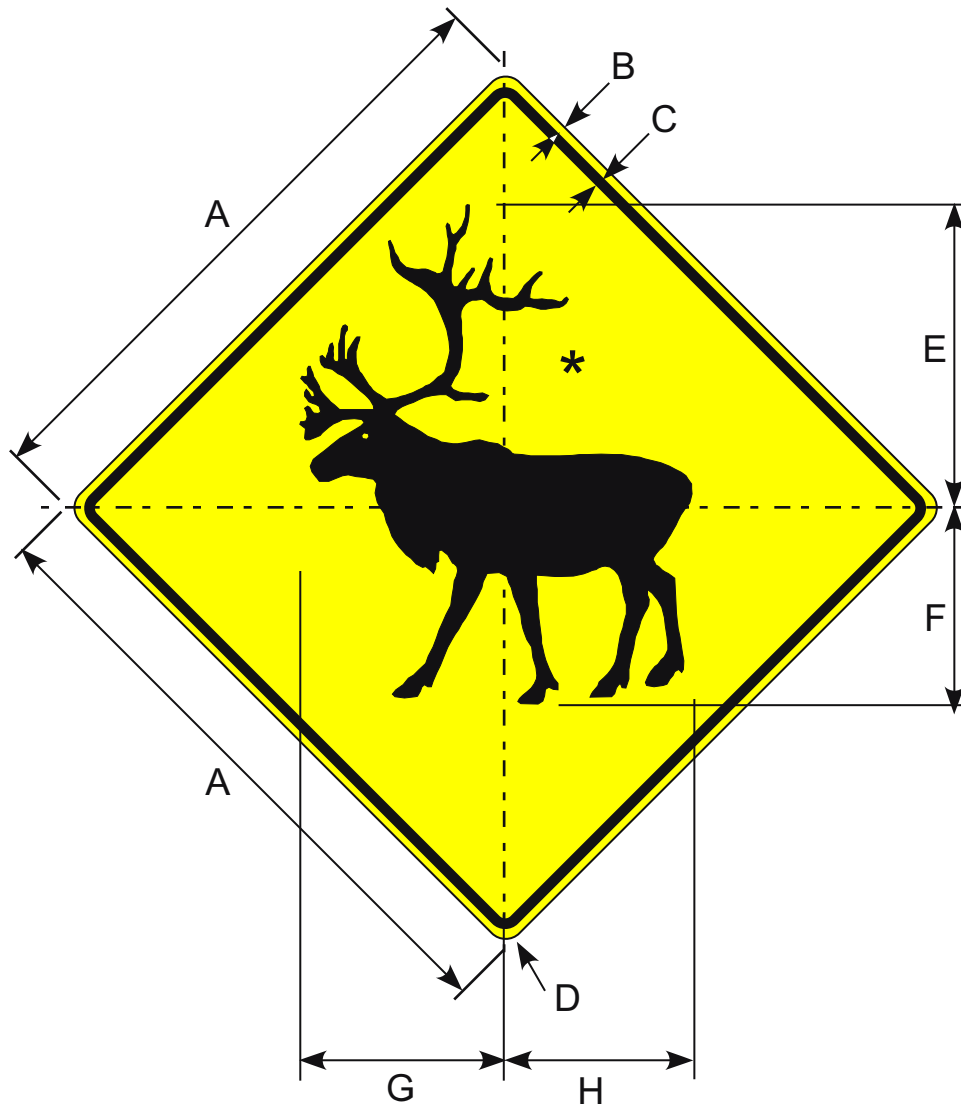

*Make symbol proportional to the graphic shown.

Border and Legend: Black
Background: Yellow

Prior to the 2002 publication of this manual, this sign was numbered W11-13.

Road Class	Dimensions (inches)							
	A	B	C	D	E	F	G	H
Minimum	30	0.50	0.75	1.88	13.31	9.25	8.63	7.69
Conventional	36	0.63	0.88	2.25	16.00	11.06	10.31	9.20
Expwy/Fwy	48	0.75	1.25	3.00	21.25	14.75	13.75	12.26

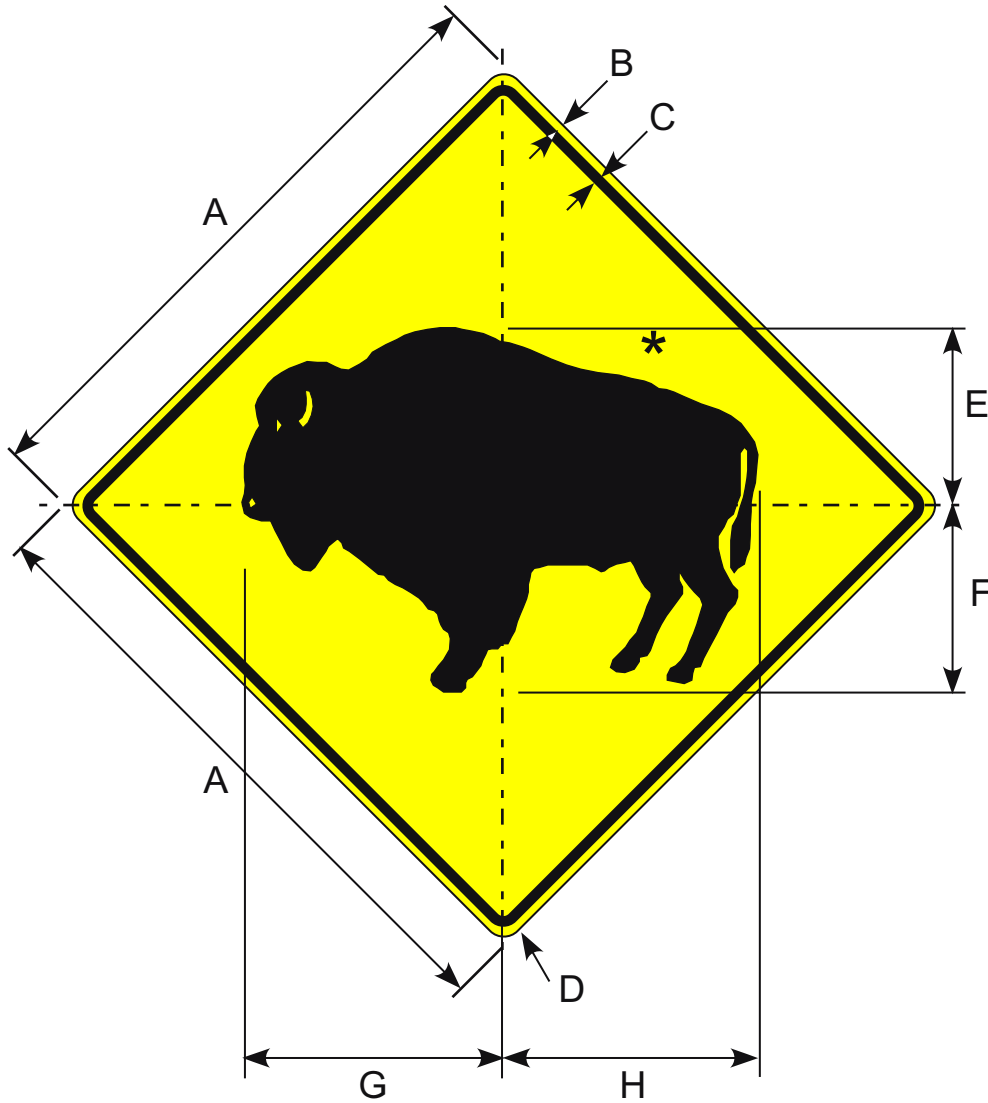

*Make symbol proportional to the graphic shown.

Border and Legend: Black
Background: Yellow

Prior to the 2002 publication of this manual, this sign was numbered W11-14.

Road Class	Dimensions (inches)						
	A	B	C	D	E	F	G
Minimum	30	0.50	0.75	1.88	7.19	8.25	11.88
Conventional	36	0.63	0.88	2.25	8.38	10.25	14.25
Expwy/Fwy	48	0.75	1.25	3.00	11.63	13.63	19.00

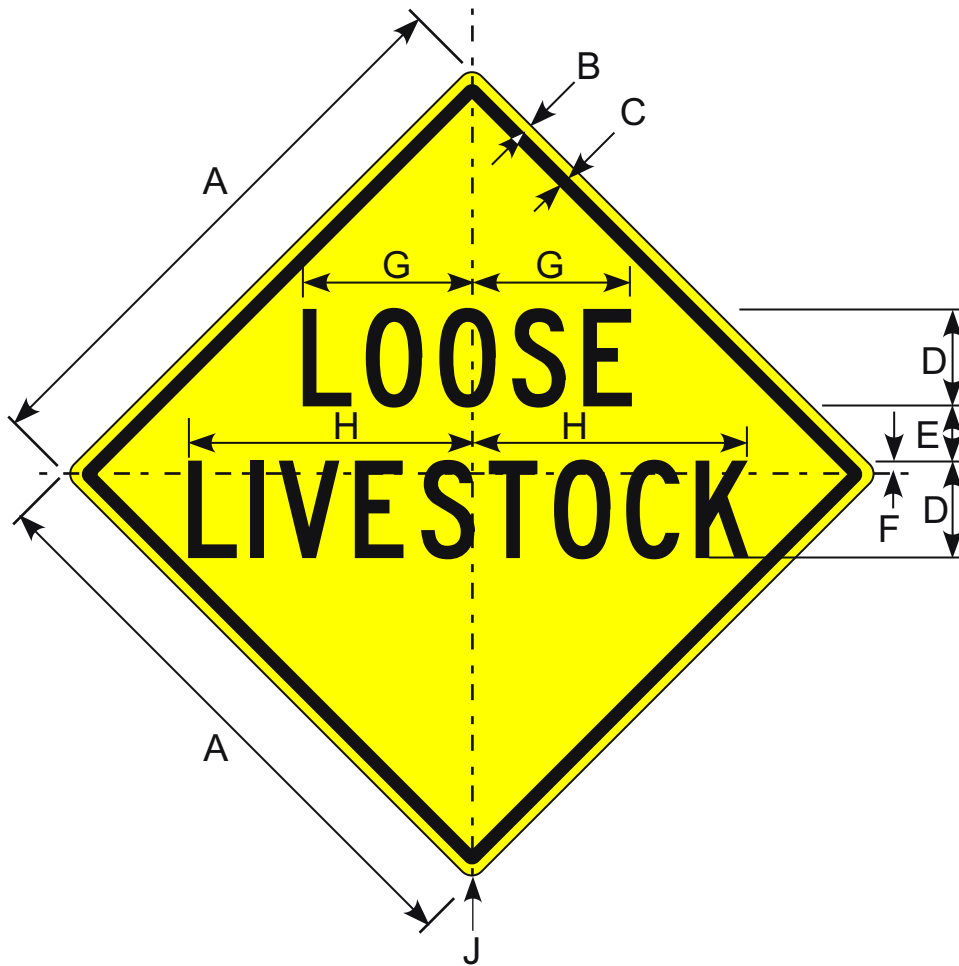

Border and Legend: Black
Background: Yellow

Prior to the 2002 publication of this manual, this sign was numbered W11-20.

Road Class	Dimensions (inches)									
	A	B	C	D	E	F	G	H	J	
Minimum	30	0.50	0.75	4D	3.00	0.50	8.19	13.94	1.88	
Conventional	36	0.63	0.88	6C	3.50	0.75	10.25	17.00	2.25	

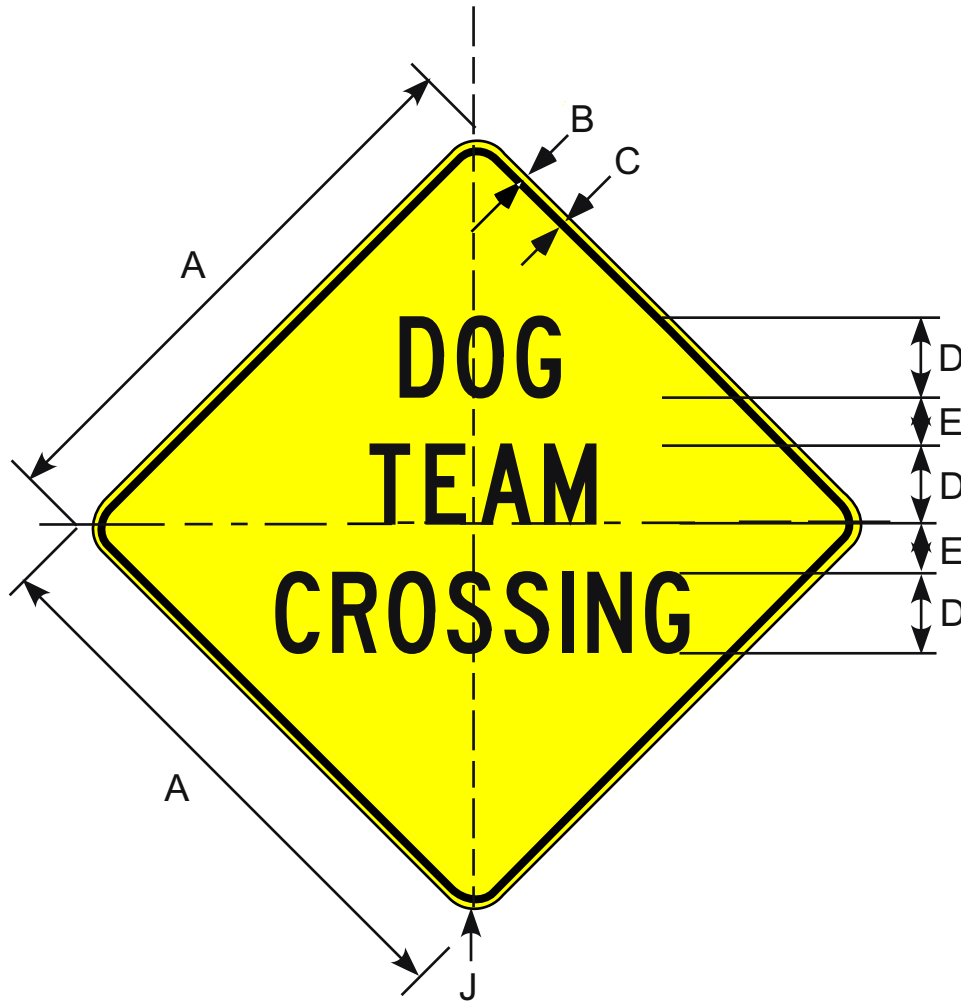

Border and Legend: Black
 Background: Yellow

Road Class	Dimensions (inches)					
	A	B	C	D	E	J
Minimum	30	0.50	0.75	4C	2.50	1.88
Conventional	36	0.63	0.88	5C	3.00	2.25

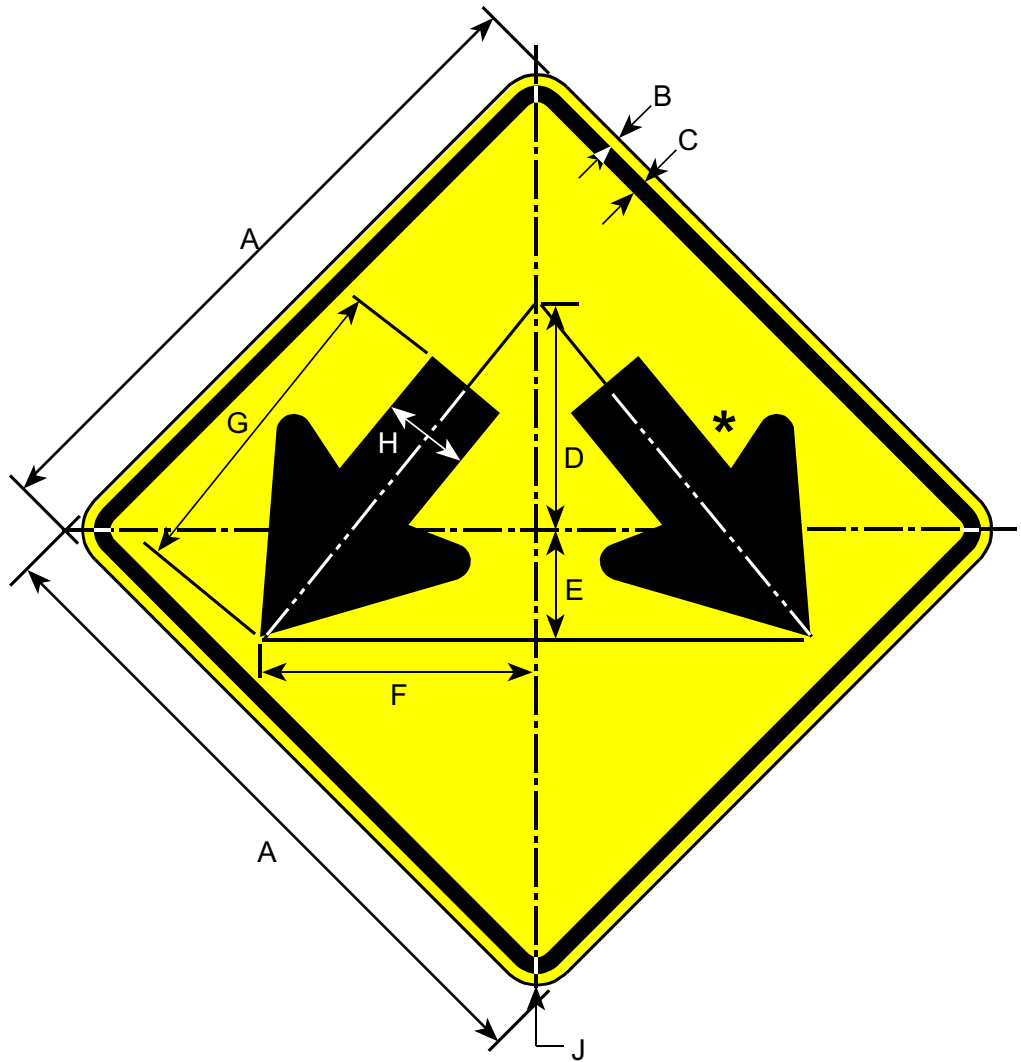

Border and Legend: Black
Background: Yellow

* See Appendix B-1 for Standard Arrow Details.

Road Class	Dimensions (inches)								
	A	B	C	D	E	F	G	H	J
Minimum	30	0.50	0.75	10	5.25	12.38	14.69	4.0	1.88
Conventional	36	0.63	0.88	12	6.13	14.63	17.5	4.75	2.25

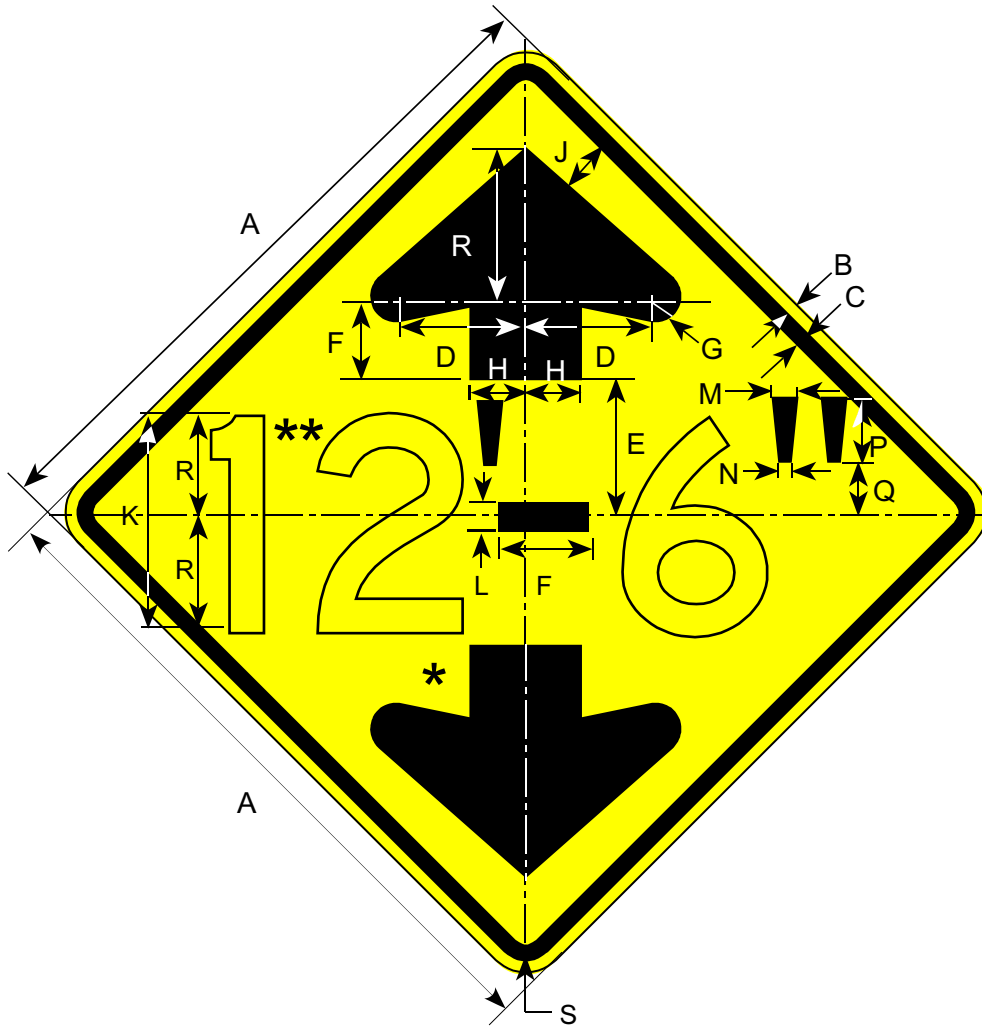

Border and Legend: Black
Background: Yellow

* See Appendix B-1 for Standard Arrow Details.

**If clearance height does not fit on sign
reduce letter series or height as necessary.

Road Class	Dimensions (inches)										
	A	B	C	D	E	F	G	H	J	K	L
Minimum	30	0.50	0.75	5.75	6.63	3.75	0.75	2.5	1.69	10D	1.56
Conventional	36	0.63	0.88	6.88	8.0	4.5	1.06	3.0	2.0	12D	1.88
Expwy/Fwy	48	0.75	1.25	9.19	10.63	5.88	1.3	4.0	2.63	16D	2.44

M	N	P	Q	R	S
1.0	0.44	2.25	3.31	5.0	1.88
1.25	0.50	2.75	4.0	6.0	2.25
1.63	0.63	3.63	5.5	8.0	3.0

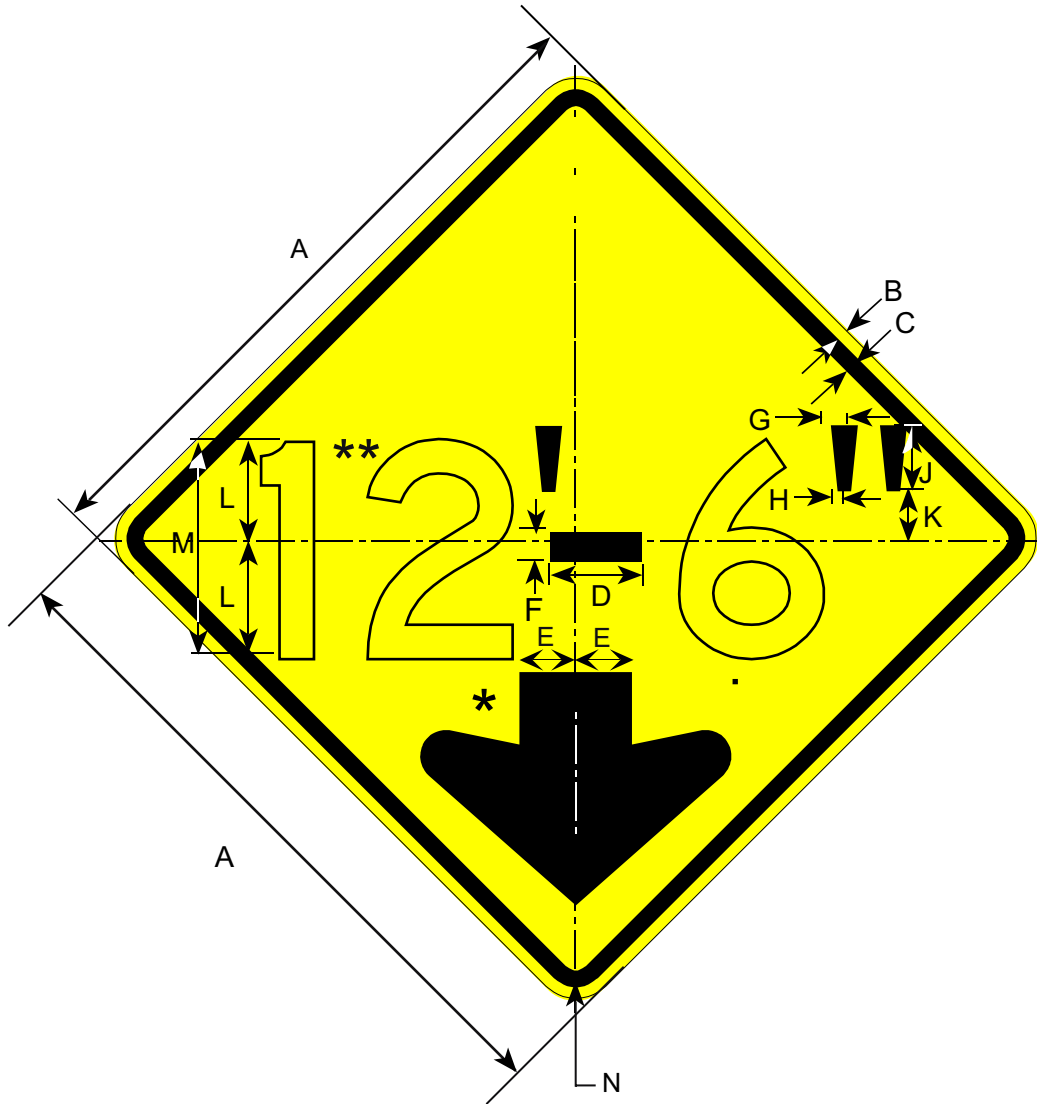

Border and Legend: Black
Background: Yellow

* See Appendix B-1 for Standard Arrow Details.

**If clearance height does not fit on sign
reduce letter series or height as necessary.

Road Class	Dimensions (inches)												
	A	B	C	D	E	F	G	H	J	K	L	M	N
Minimum	30	0.50	0.75	4.13	2.5	1.56	1.0	0.44	2.25	3.31	5.0	10D	1.88
Conventional	36	0.63	0.88	5.0	3.0	1.88	1.25	0.50	2.75	4.0	6.0	12D	2.25
Expwy/Fwy	48	0.75	1.25	6.56	4.0	2.44	1.63	0.63	3.63	5.5	8.0	16D	3.0

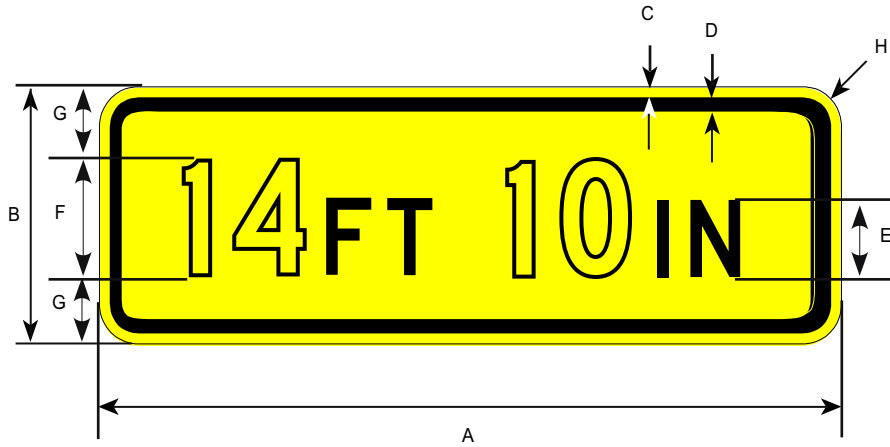

Border and Legend: Black
Background: Yellow

Prior to the 2002 publication of this manual, this sign was numbered CW12-2C.

Road Class	Dimensions (inches)							
	A	B	C	D	E	F	G	H
Minimum	54	18	0.50	0.75	6D	8D	5.0	3.0
Conventional	78	24	0.63	0.88	8D	12D	6.0	3.0
Expwy/Fwy	108	36	0.75	1.25	12D	16D	10	3.0



Border and Legend: Black
Background: Yellow

* Reduce spacing by 14%.

Prior to the 2002 publication of this manual, this sign was numbered W12-2B.

Road Class	Dimensions (inches)							
	A	B	C	D	E	F	G	J
Conventional	24	18	0.38	0.63	5D	2	3	1.5

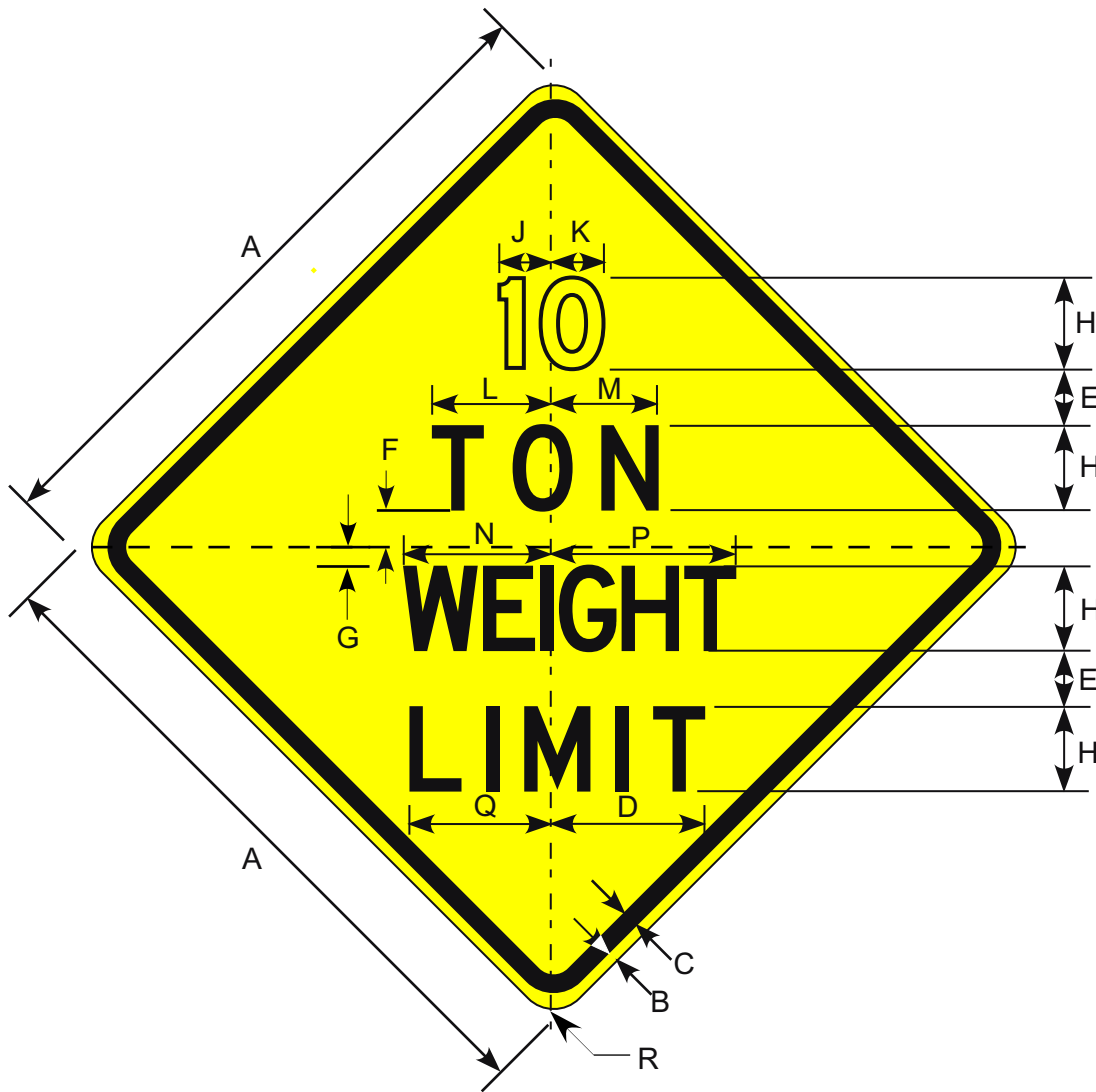

Prior to the 2002 publication of this manual, this sign was numbered W12-4.

Border and Legend: Black
Background: Yellow

Road Class	Dimensions (inches)																
	A	B	C	D	E	F	G	H	J	K	L	M	N	P	Q	R	
Minimum	30	0.50	0.75	7.13	2.5	1.63	0.88	4D	2.38	2.5	5.44	5.0	6.75	8.56	6.5	1.88	
Conventional	36	0.63	0.88	8.25	3.0	2.0	1.0	5D	2.75	2.88	6.25	5.75	7.75	9.88	7.5	2.25	
Expwy/Fwy	48	0.75	1.25	11	4.0	2.63	1.38	6D	3.63	3.88	8.38	7.63	10.38	13.25	10	3.0	

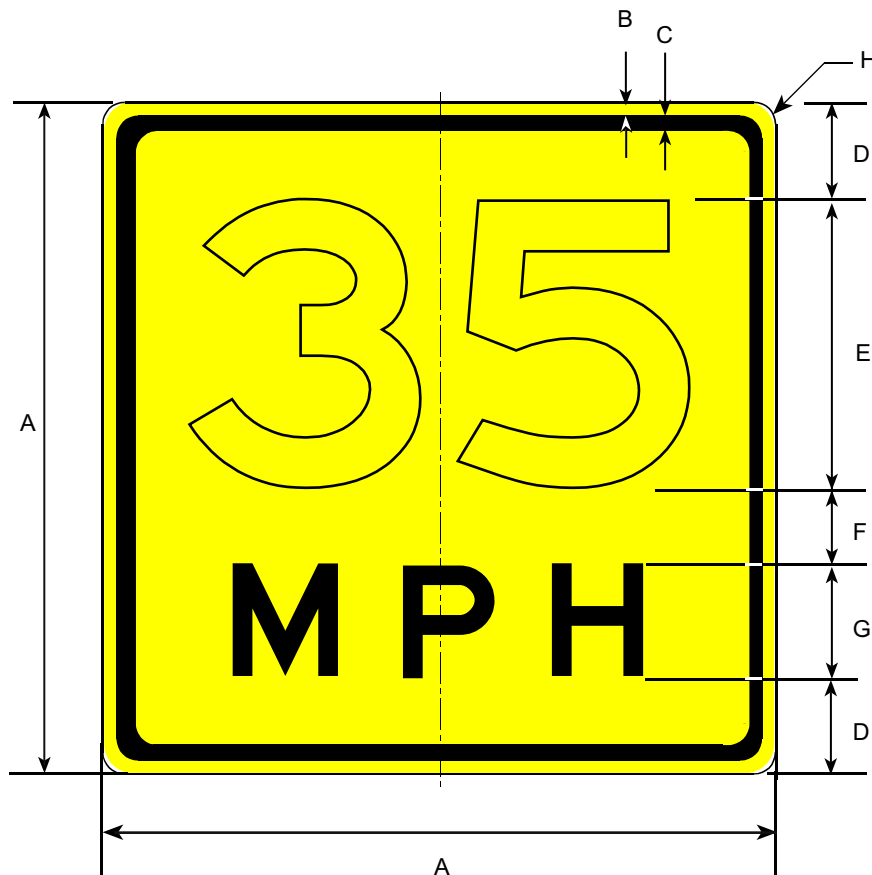

Border and Legend: Black
 Background: Yellow

Road Class	Dimensions (inches)							
	A	B	C	D	E	F	G	H
Minimum	18	0.38	0.63	2.5	8E	2.00	3E	1.1
Conventional	24	0.38	0.63	3.6	10E	2.75	4E	1.5
Expwy/Fwy	36	0.50	0.75	4.5	12E	4.00	5E	2.3

W13-1A

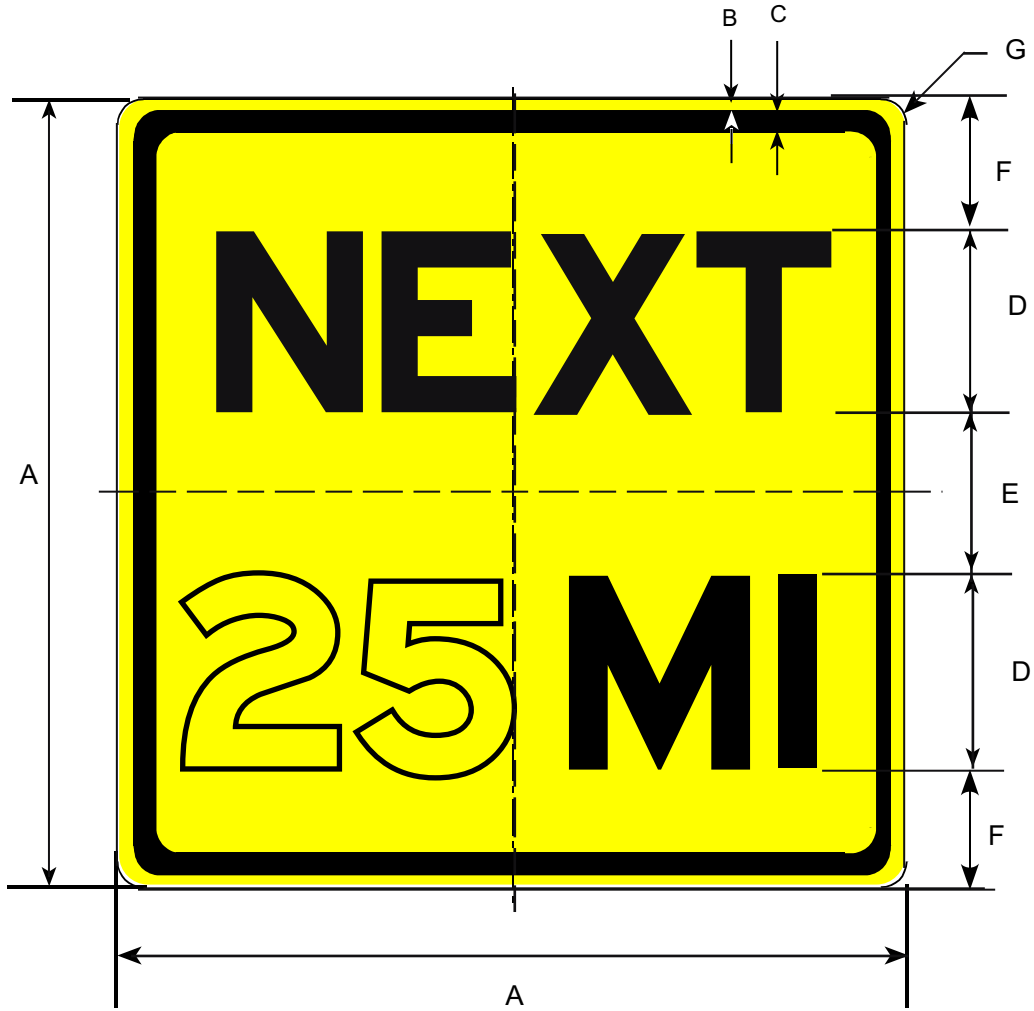

Border and Legend: Black
Background: Yellow

Road Class	Dimensions (inches)						
	A	B	C	D	E	F	G
Conventional	18	0.38	0.50	4D	3.0	3.5	1.5

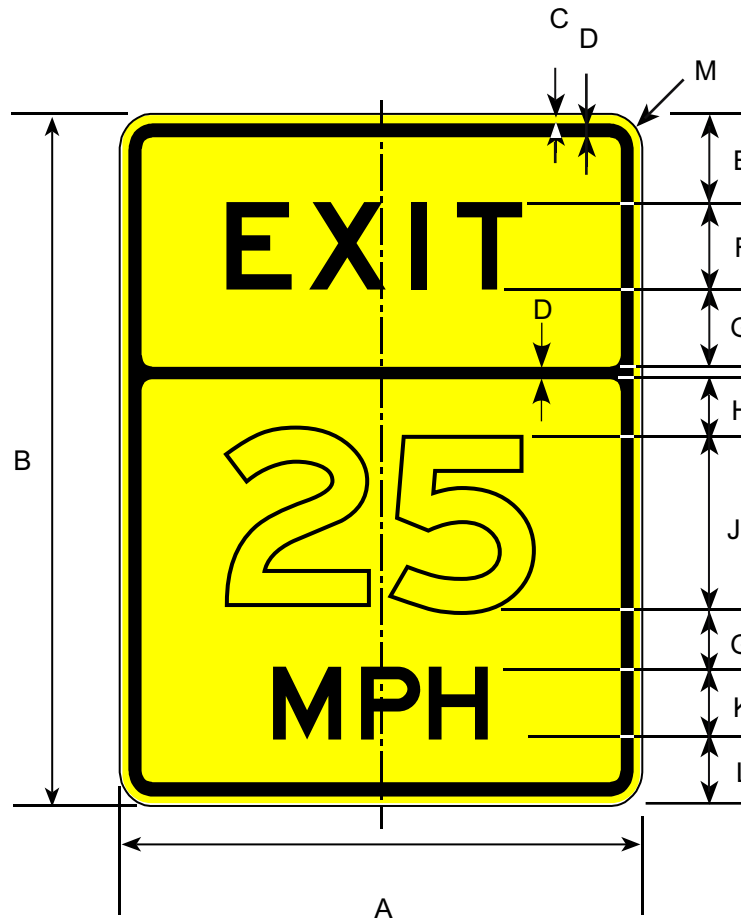

Border and Legend: Black
Background: Yellow

Road Class	Dimensions (inches)											
	A	B	C	D	E	F	G	H	J	K	L	M
Conventional	36	48	0.63	0.88	6	6E	4	5.13	12E	4E	6	2.5
Expwy/Fwy	48	60	0.75	1.25	7	8E	5	5.75	16E	6E	6	3.0

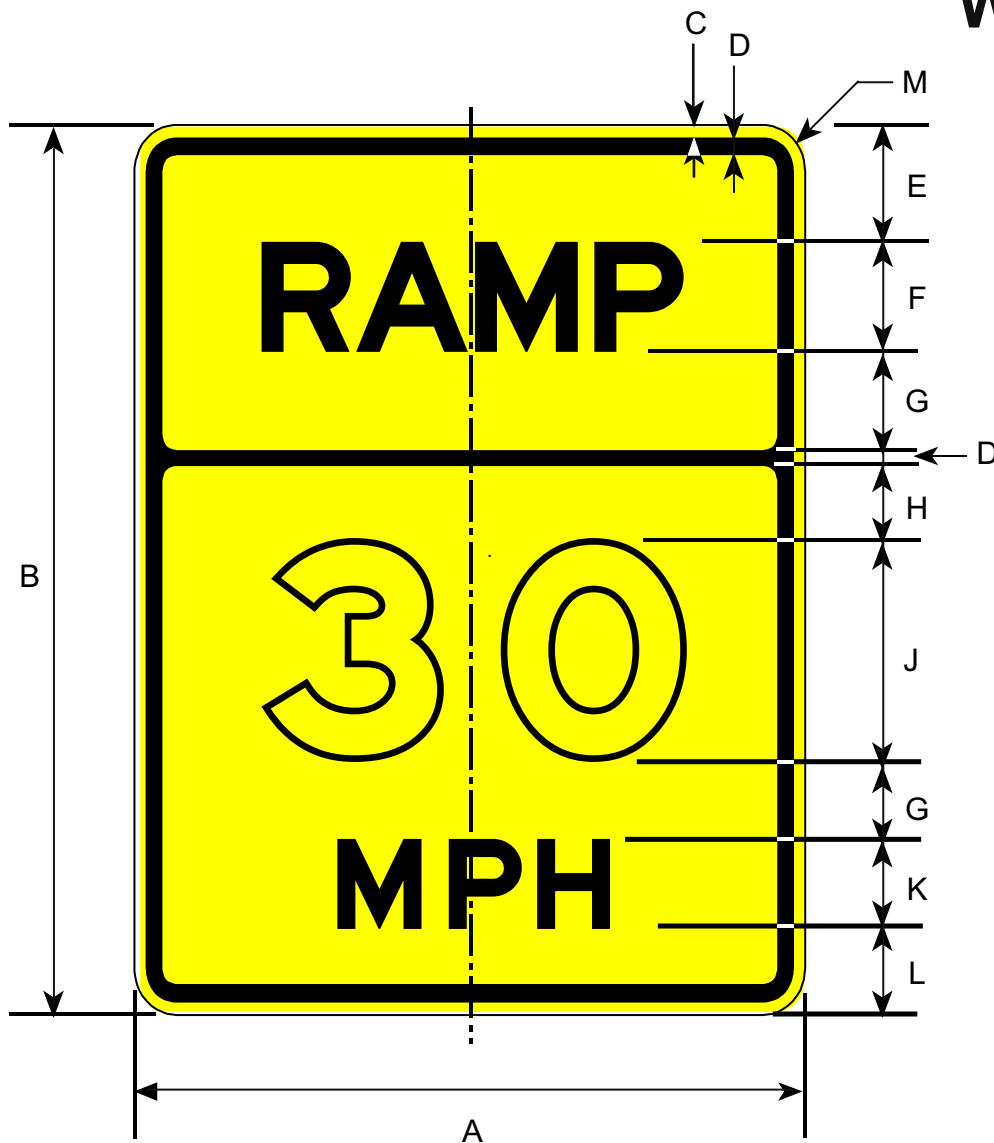

Border and Legend: Black
Background: Yellow

Road Class	Dimensions (inches)											
	A	B	C	D	E	F	G	H	J	K	L	M
Conventional	36	48	0.63	0.88	6	6E	4	5.13	12E	4E	6	2.5
Expwy/Fwy	48	60	0.75	1.25	7	8E	5	5.75	16E	6E	6	3.0

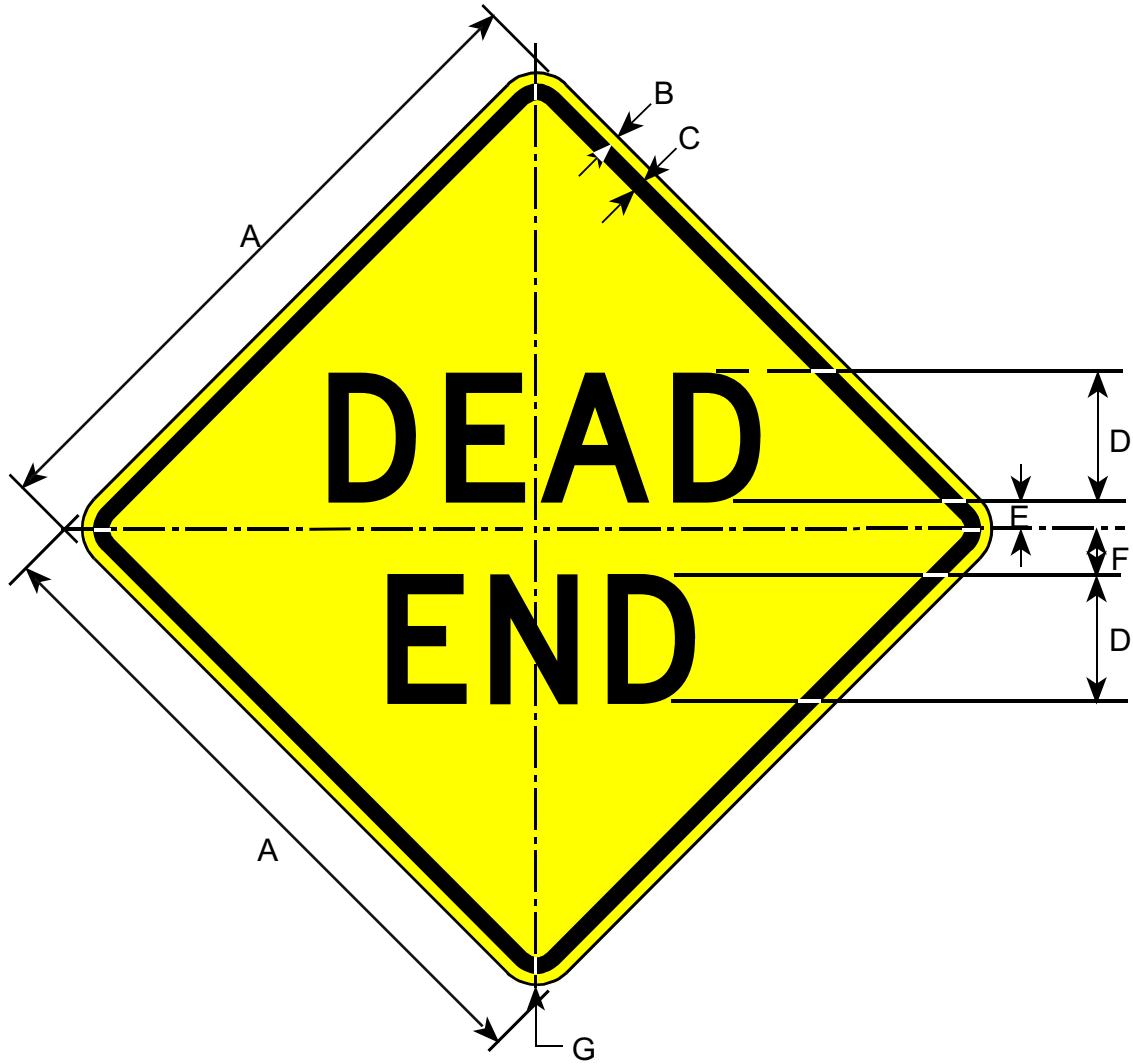

Border and Legend: Black
Background: Yellow

Road Class	Dimensions (inches)						
	A	B	C	D	E	F	G
Conventional	30	0.50	0.75	6D	1.5	2.5	1.88
Expwy/Fwy	36	0.63	0.88	7D	2.0	3.0	2.25

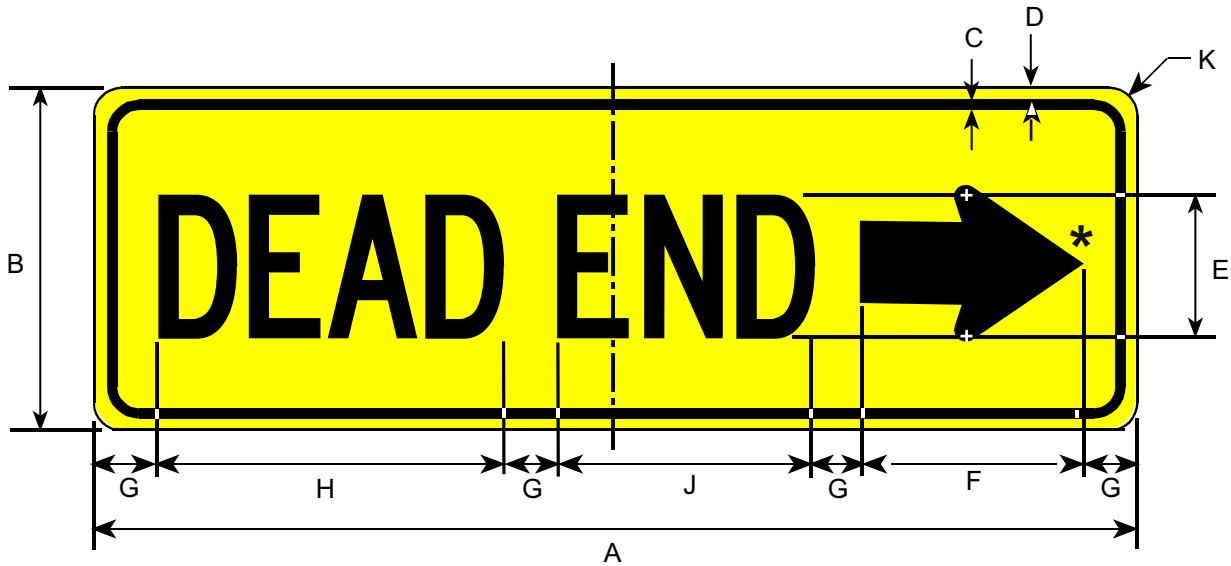

Border and Legend: Black
Background: Yellow

* See Appendix B-1 for Standard Arrow Details.

Road Class	A	B	C	D	E	F	G	H	J	K
Conventional	36	12	0.75	0.50	5C	5.0	2.0	13	10	1.5

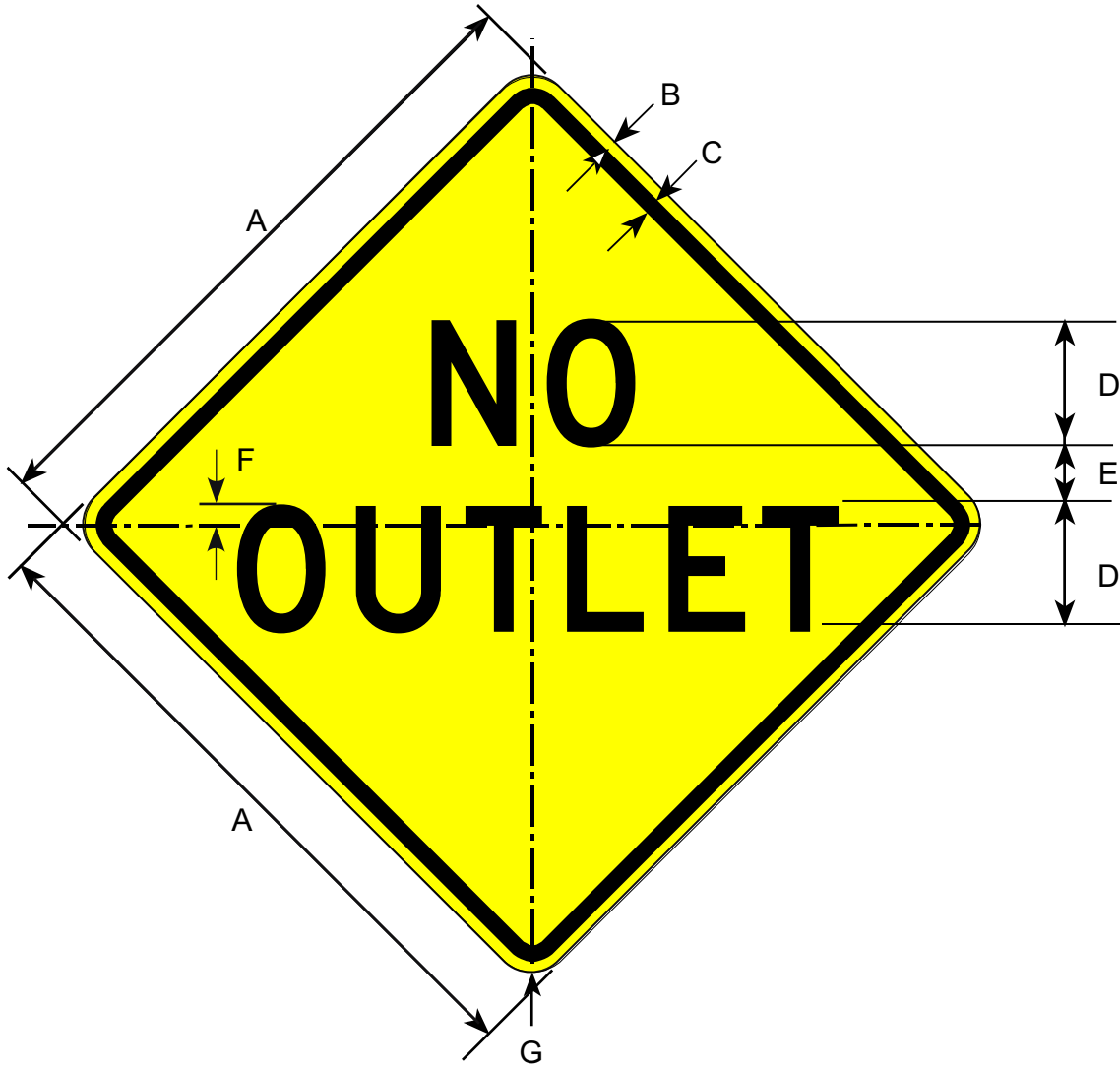

Border and Legend: Black
 Background: Yellow

Road Class	Dimensions (inches)						
	A	B	C	D	E	F	G
Minimum	30	0.50	0.75	6D	1.5	0.94	1.88
Conventional	36	0.63	0.88	7D	2.0	1.13	2.25

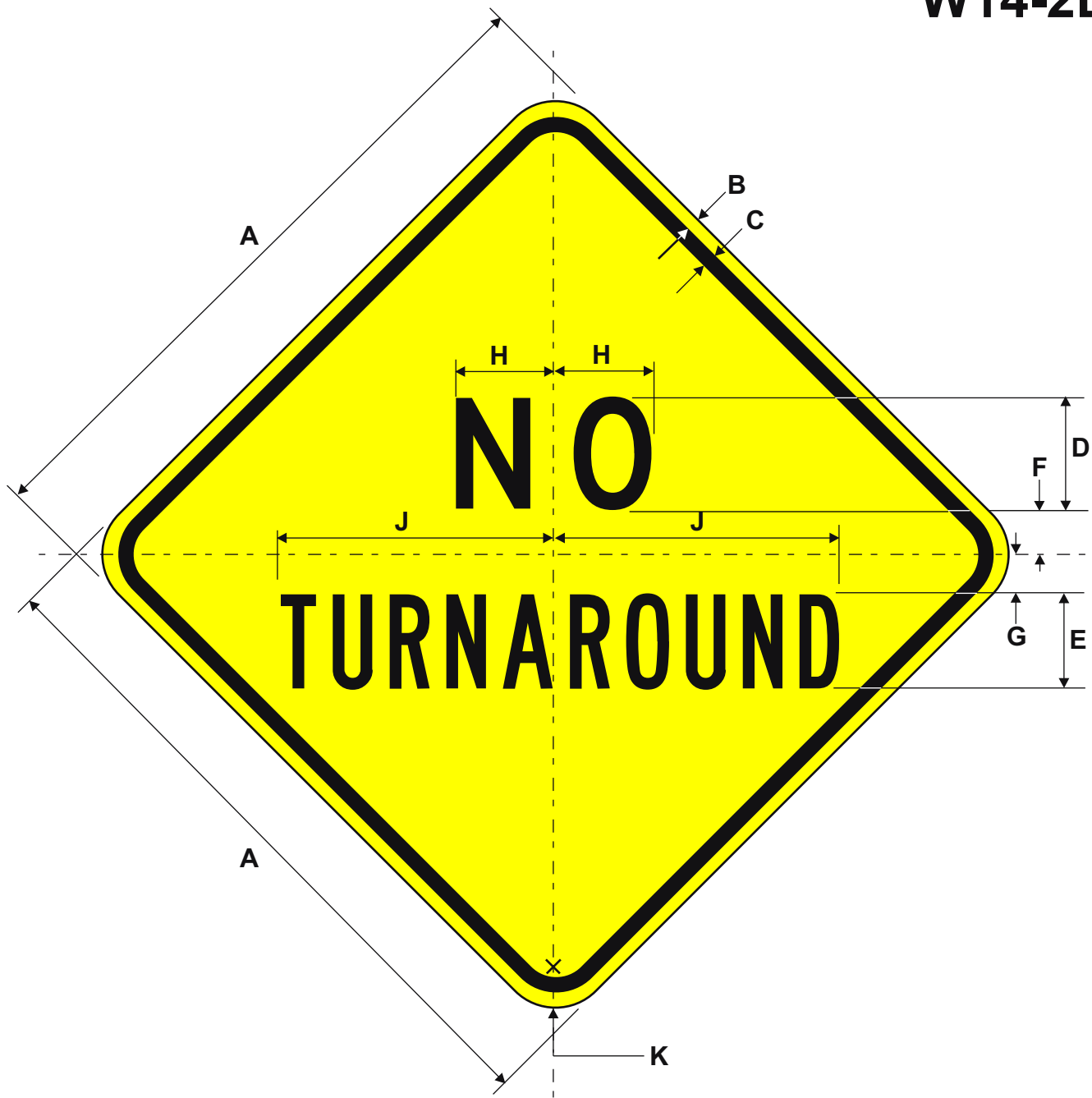

Border and Legend: Black
 Background: Yellow

Road Class	Dimensions (inches)									
	A	B	C	D	E	F	G	H	J	K
Conv/Min	36	0.63	0.88	6D	5B	2.5	2.0	5.19	14.64	2.25

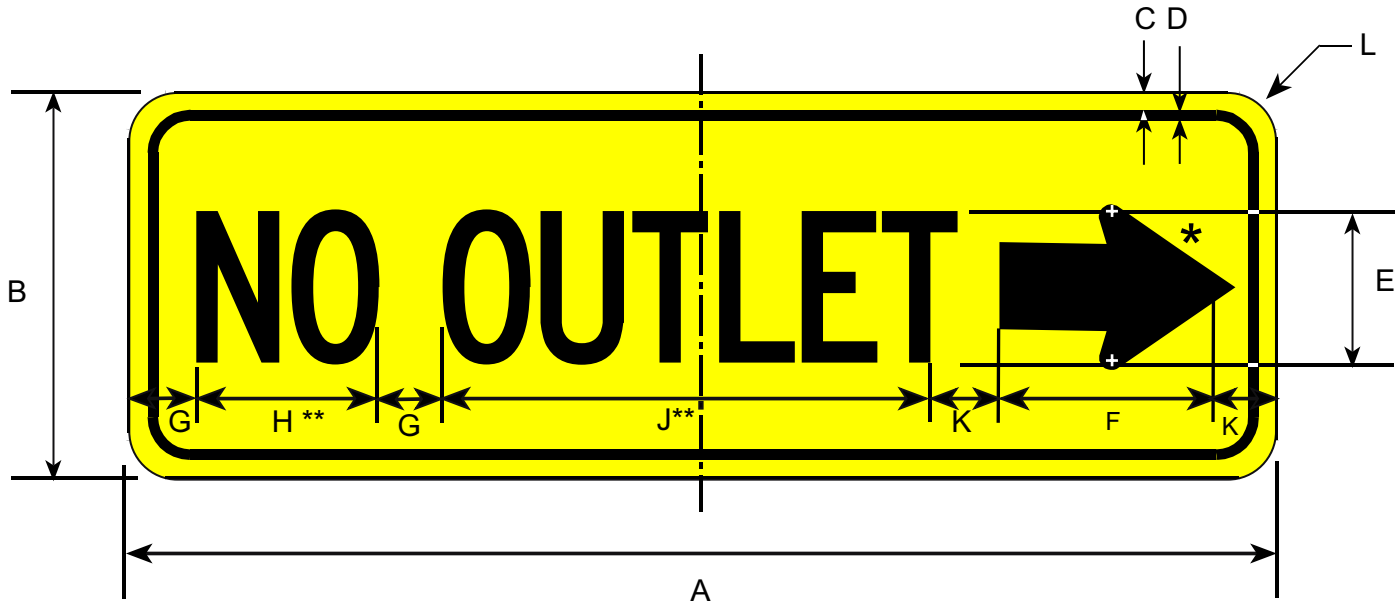

A
W14-2PR



W14-2PL

* See Appendix B-1 for Standard Arrow Details.
 **Spacing has been reduced by 50%

Border and Legend: Black
 Background: Yellow

Road Class	Dimensions (inches)										
	A	B	C	D	E	F	G	H	J	K	L
Conventional	36	12	0.75	0.50	5C	5.0	1.75	6.13	17	2.19	1.5

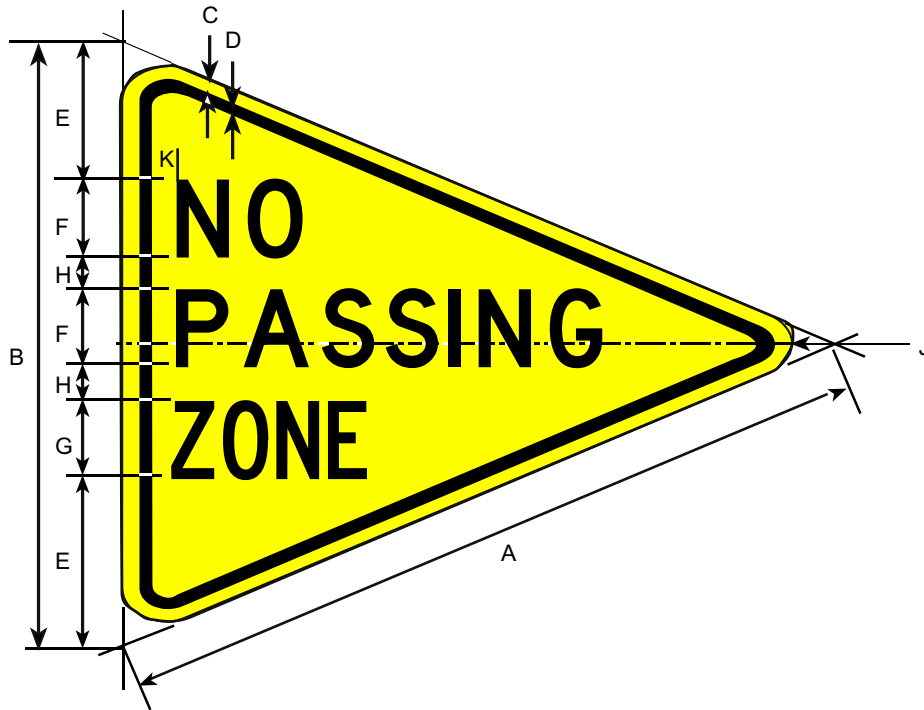

Border and Legend: Black
Background: Yellow

Road Class	Dimensions (inches)									
	A	B	C	D	E	F	G	H	J	K
Minimum	40	30	0.50	0.75	7.25	4D	4C	1.75	1.88	2.5
Conventional	48	36	0.63	0.88	8.50	5D	5C	2.00	2.25	3.0
Oversized	64	48	0.75	1.25	12.00	6D	6C	3.00	3.00	4.0

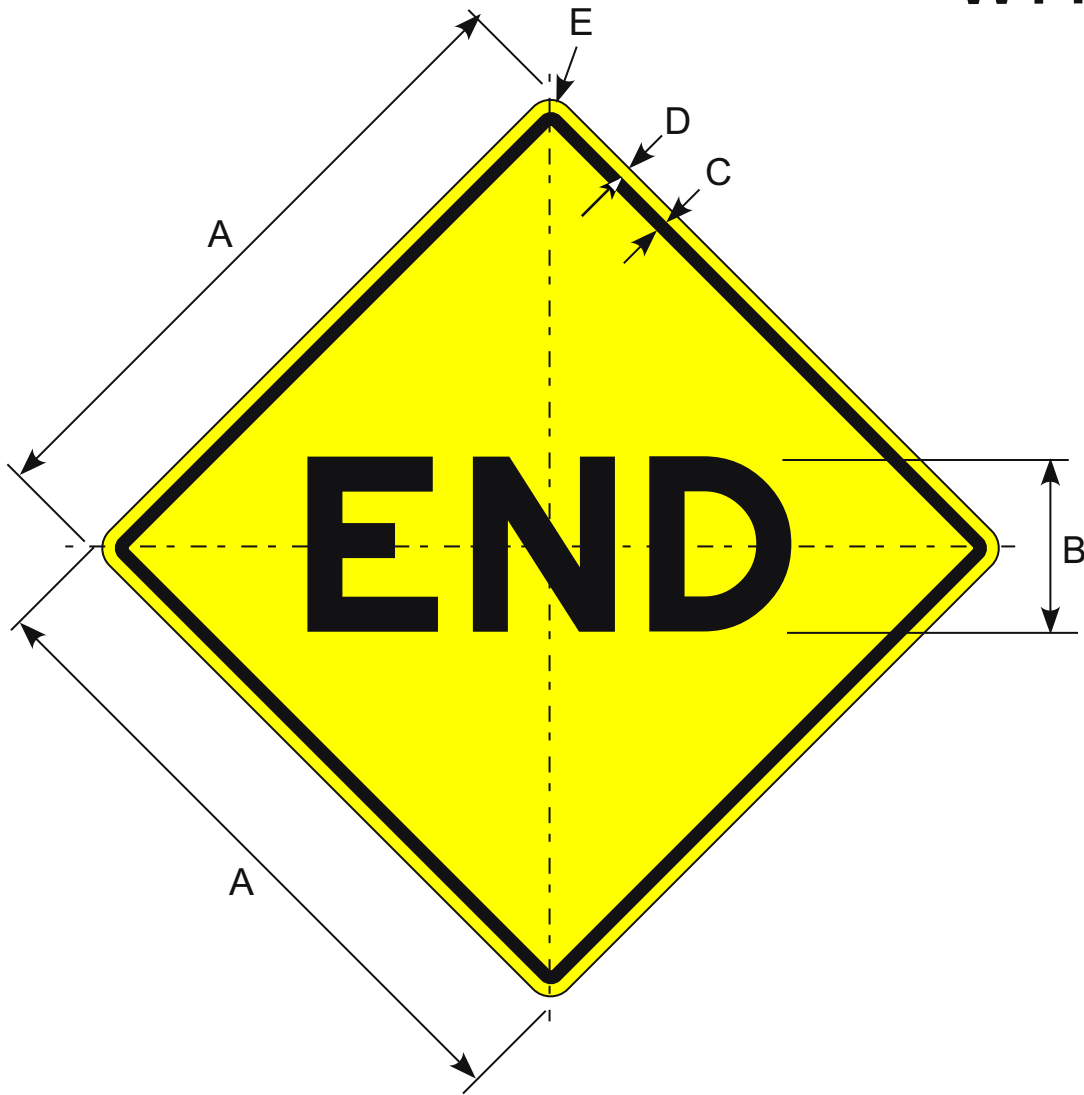

Border and Legend: Black
 Background: Yellow

Prior to the 2002 publication of this manual, this sign was numbered W14-2A.

Road Class	Dimensions (inches)				
	A	B	C	D	E
Conventional	30	8E	0.75	0.5	2.25

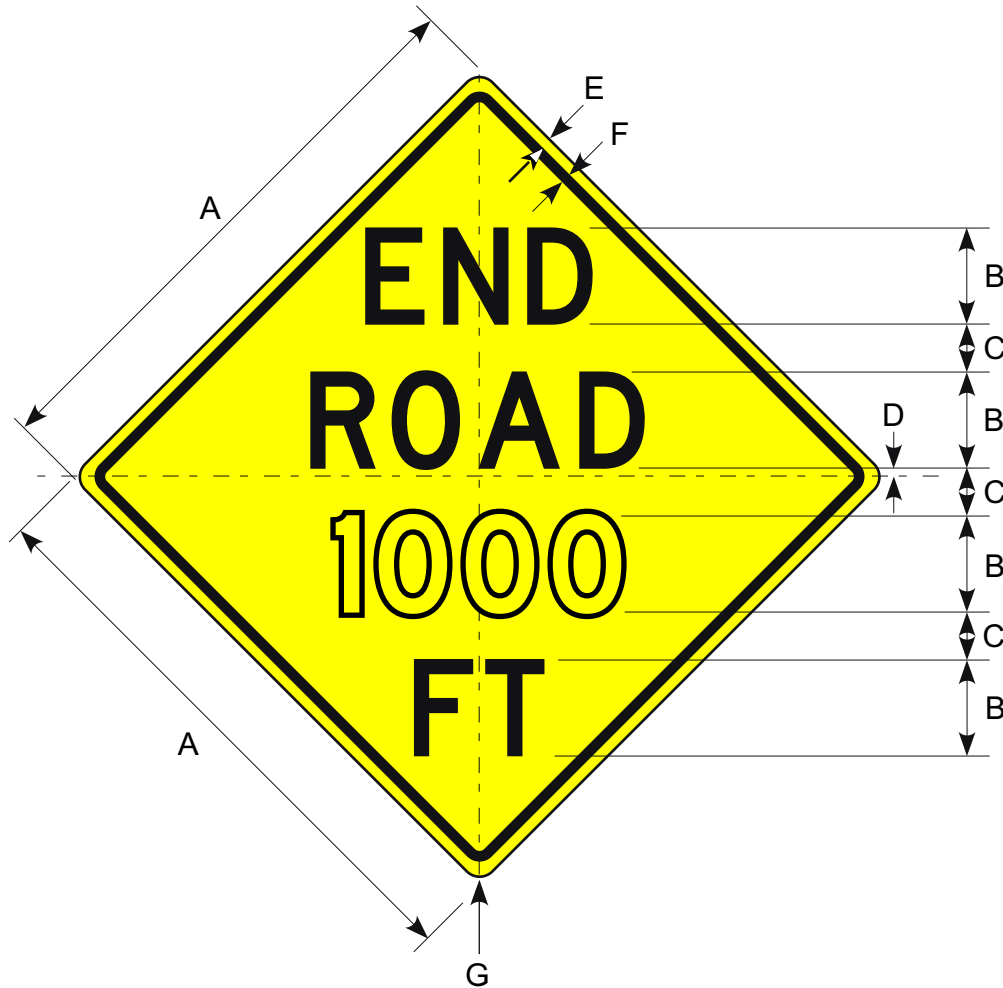

Border and Legend: Black
Background: Yellow

Prior to the 2002 publication of this manual, this sign was numbered W14-2B.

Road Class	Dimensions (inches)						
	A	B	C	D	E	F	G
Minimum	30	5D	2.5	0.38	0.50	0.75	1.88
Conventional	36	6D	3.0	0.50	0.75	1.25	2.25

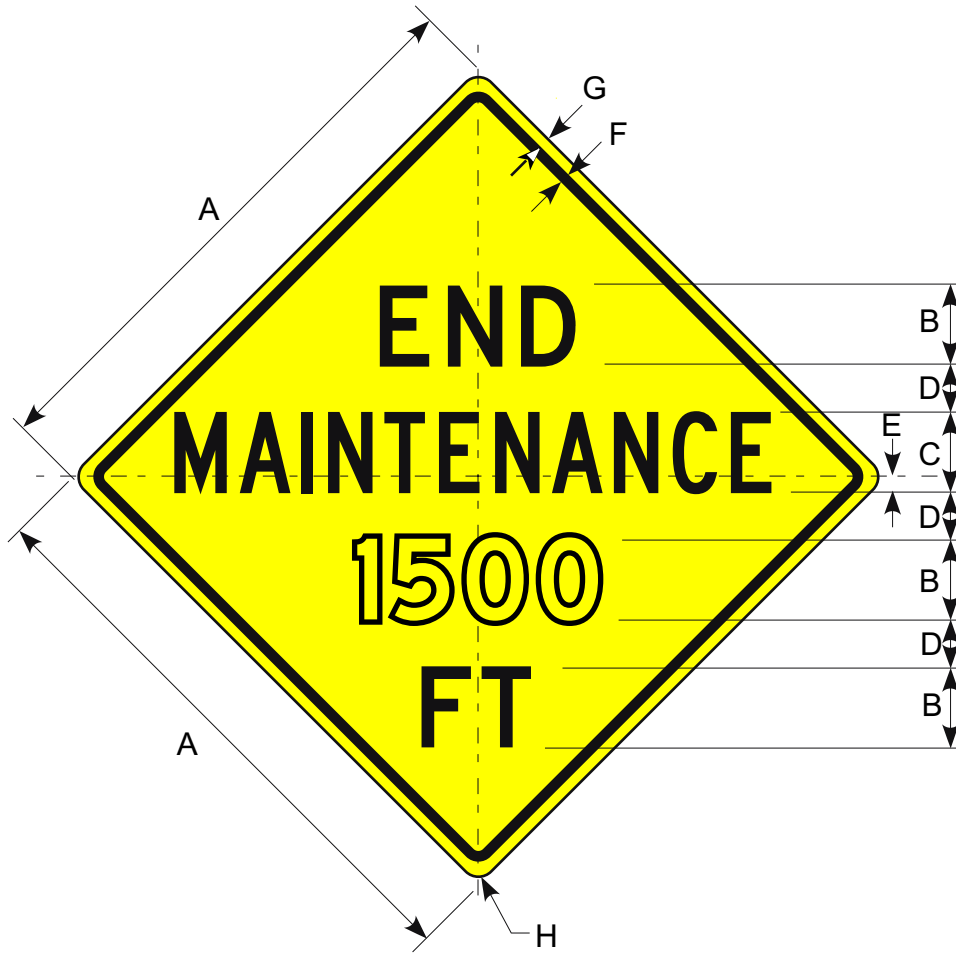

Border and Legend: Black
 Background: Yellow

Prior to the 2002 publication of this manual, this sign was numbered W14-2C.

Road Class	Dimensions (inches)							
	A	B	C	D	E	F	G	H
Minimum	30	4D	4C	2.75	0.88	0.75	0.50	1.88
Conventional	36	5D	5C	3.00	1.00	0.88	0.63	2.25

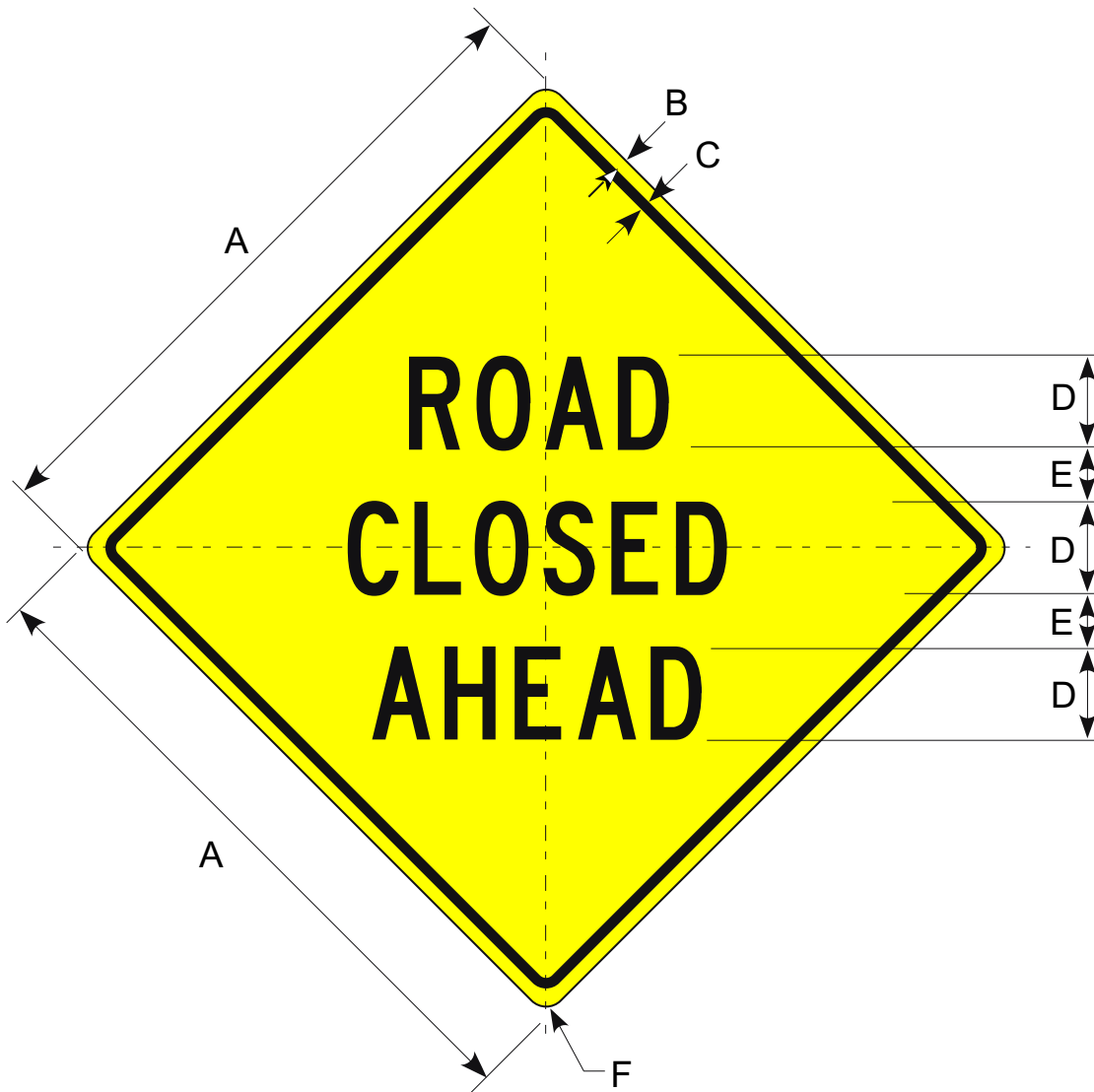

Border and Legend: Black
Background: Yellow

Prior to the 2002 publication of this manual, this sign was numbered W14-5A.

Road Class	Dimensions (inches)					
	A	B	C	D	E	F
Minimum	30	0.50	0.75	4C	2.63	1.88
Conventional	36	0.63	0.88	5C	3.25	2.25
Expwy/Fwy	48	0.75	1.25	6C	4.00	3.00

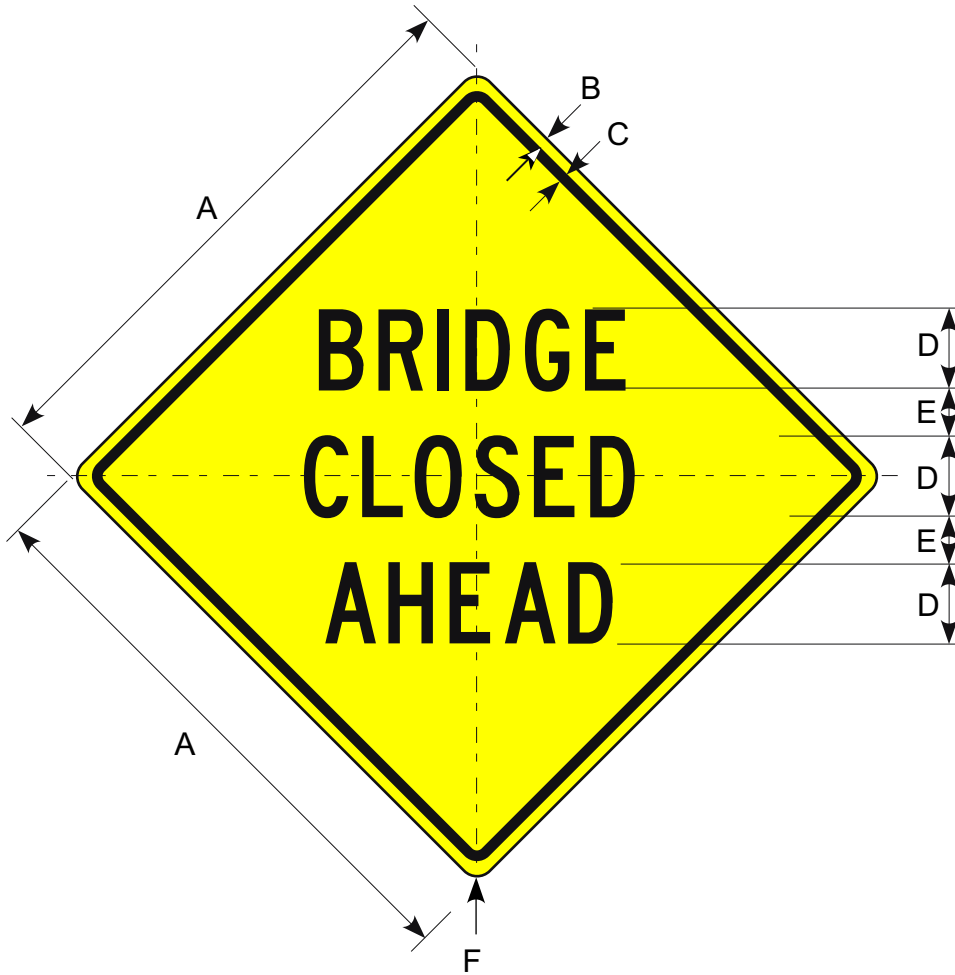

Border and Legend: Black
Background: Yellow

Prior to the 2002 publication of this manual, this sign was numbered W14-5B.

Road Class	Dimensions (inches)					
	A	B	C	D	E	F
Minimum	30	0.50	0.75	4C	2.63	1.88
Conventional	36	0.63	0.88	5C	3.25	2.25
Expwy/Fwy	48	0.75	1.25	6C	4.00	3.00

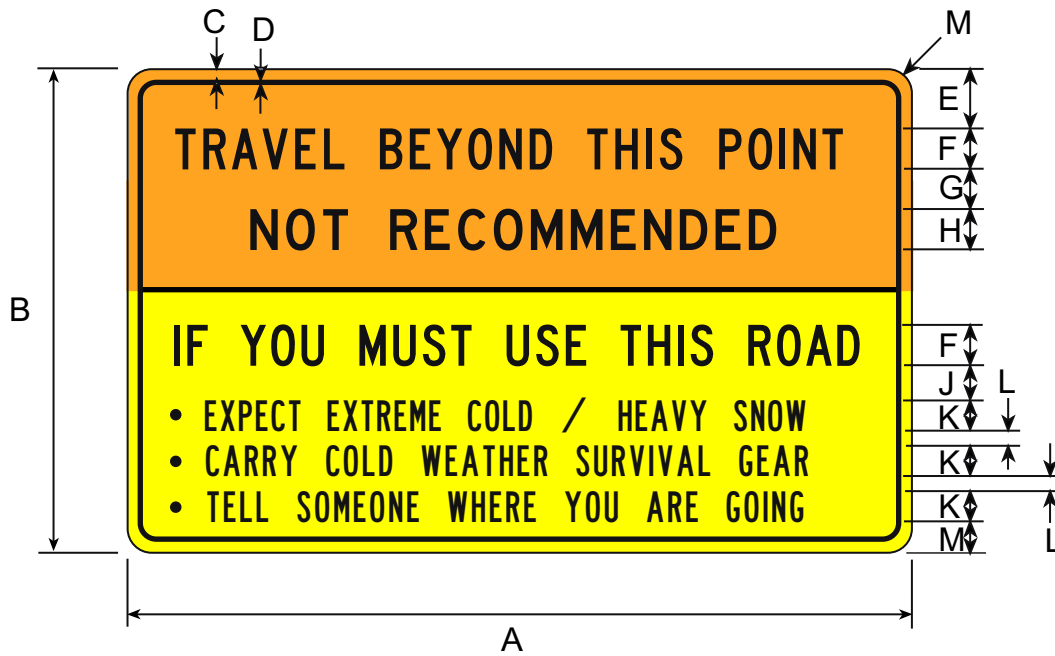

Border and Legend: Black
 Upper Background: Orange
 Lower Background: Yellow

Road Class	Dimensions (inches)											
	A	B	C	D	E	F	G	H	J	K	L	M
Conv & Min	78	48	1.33	1.75	6	4C	4	4D	3.5	3B	1.5	3

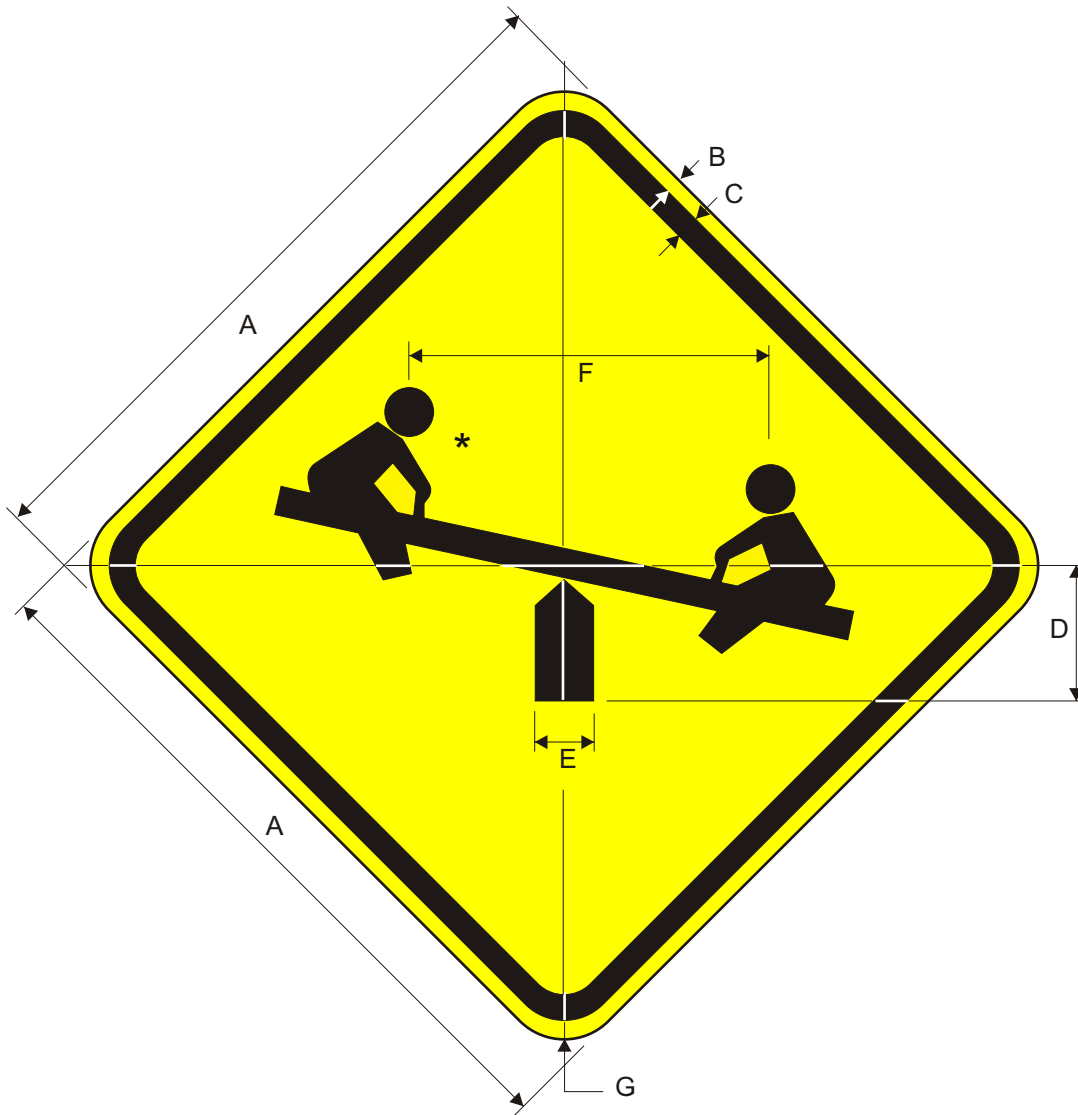

*Make symbol proportional to the graphic shown.

Border and Legend: Black
Background: Yellow

Prior to the 2006 publication of this manual, this sign was numbered W11-106.

Road Class	Dimensions (inches)						
	A	B	C	D	E	F	G
Min.	24	0.38	0.63	4.6	2.0	12.4	1.5
Conv.	30	0.50	0.75	5.75	2.5	15.5	1.88
Oversized	36	0.63	0.88	7.0	3.0	18.63	2.25

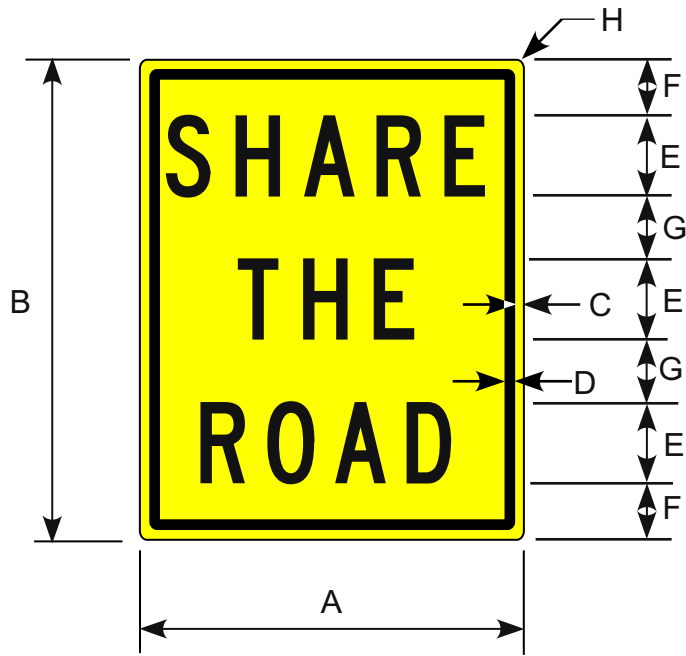

Border and Legend: Black
 Background: Yellow

Road Class	Dimensions (inches)							
	A	B	C	D	E	F	G	H
Minimum	18	24	0.38	0.63	4C	2.0	4.0	1.13
Conventional	24	30	0.38	0.63	5C	3.5	4.0	1.5

W16-2P

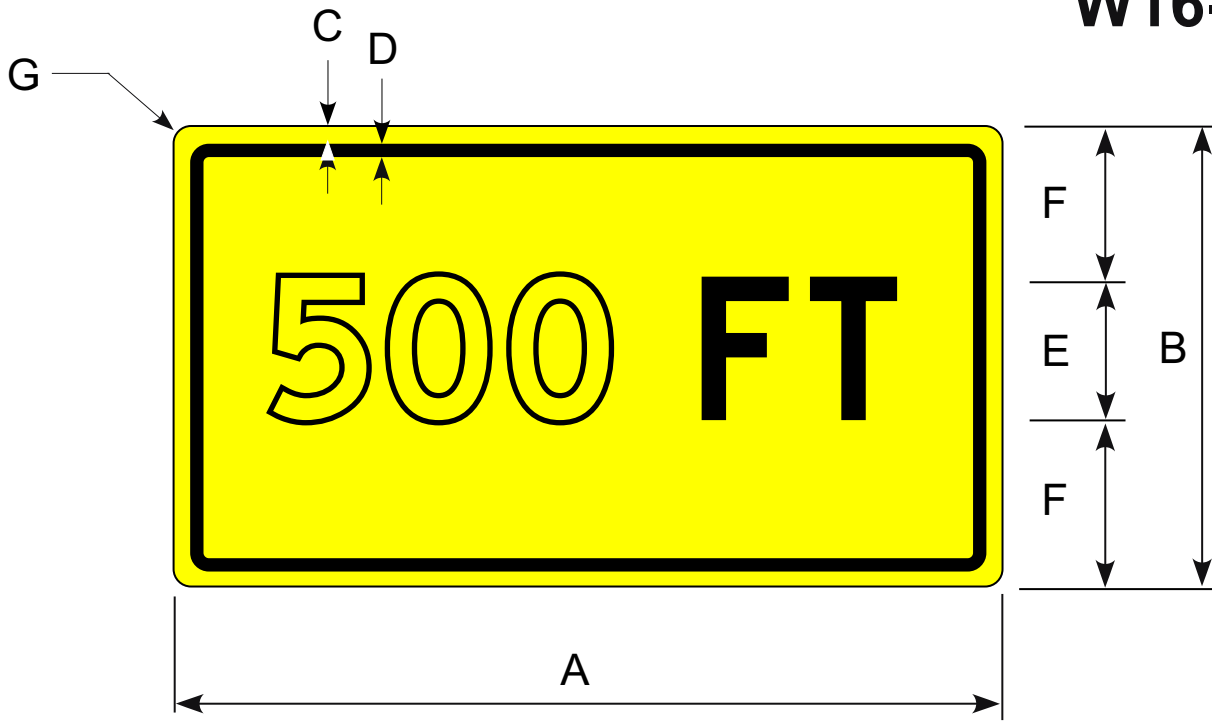

Border and Legend: Black
 Background: Yellow or Orange

Road Class	Dimensions (inches)						
	A	B	C	D	E	F	G
Minimum	24	12	0.50	0.50	4D	10	1.88
Conventional	36	20	0.63	0.88	6D	15	2.25
Expwy/Fwy	48	30	0.75	1.25	8D	20	3.00

W16-3
W16-3A
W16-4

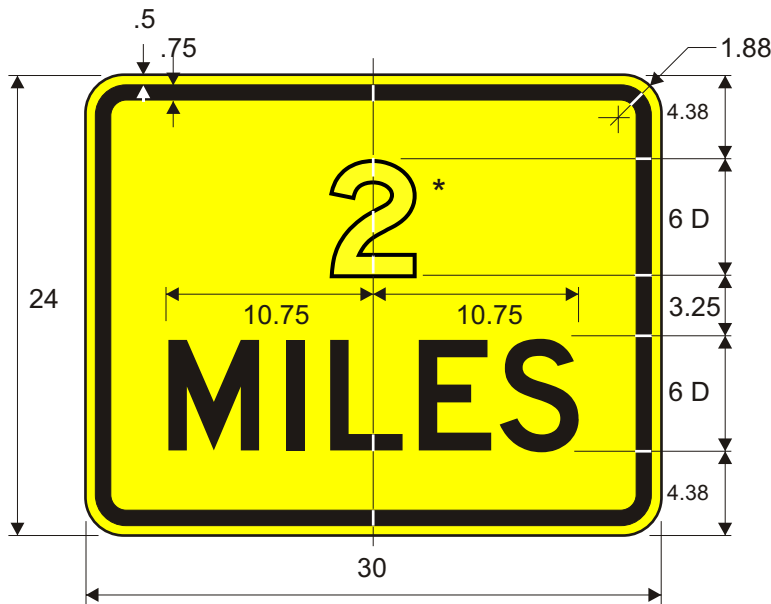

W16-3

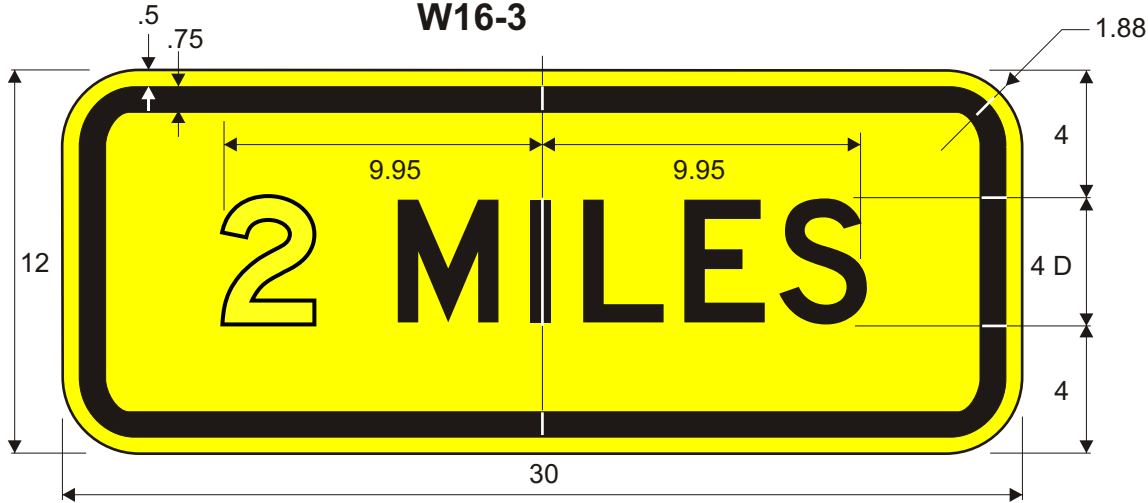

W16-3a

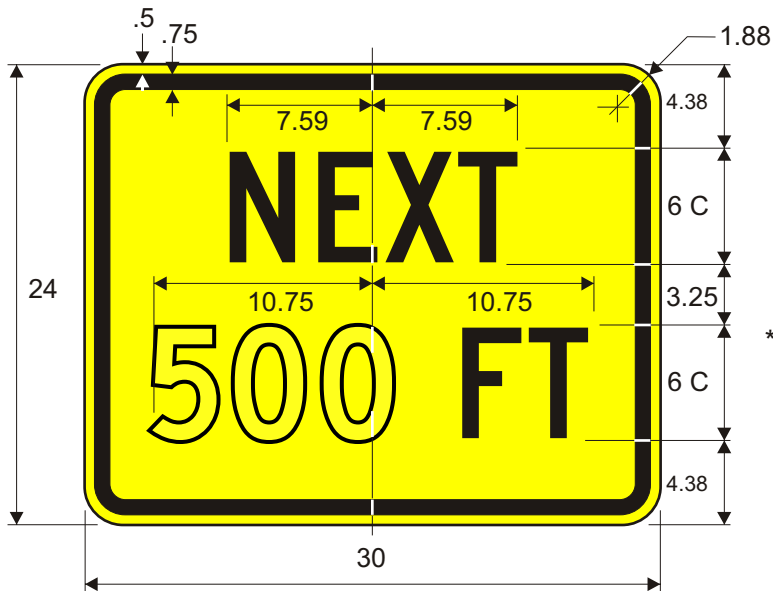

W16-4

*Optically locate numerals about centerline.

Border and Legend: Black
 Background: Yellow

W16-5P
W16-6P

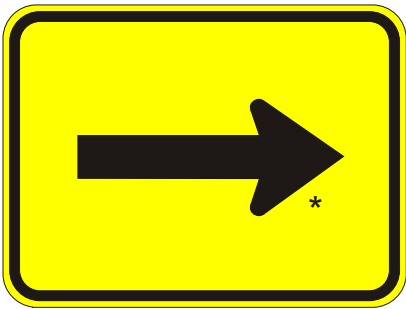

W16-5pR

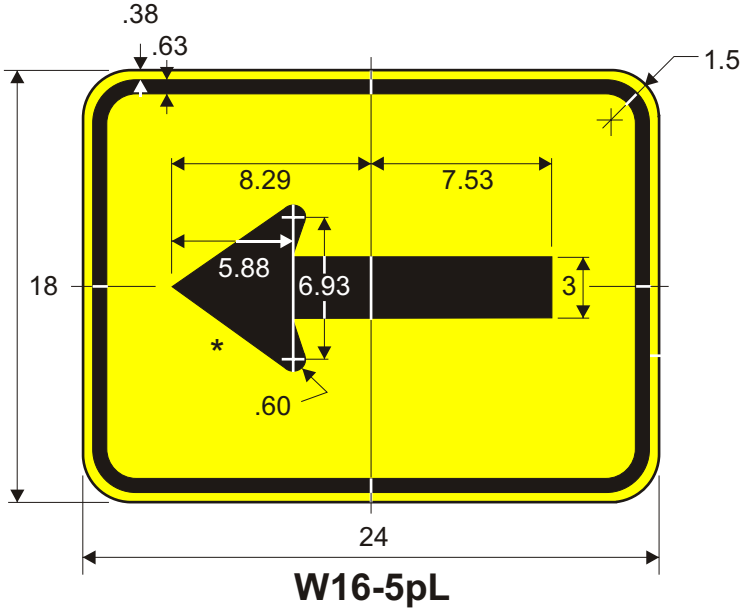

W16-5pL

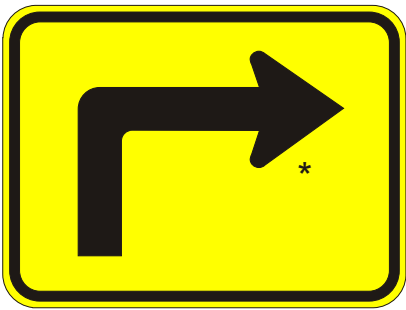

W16-6pR

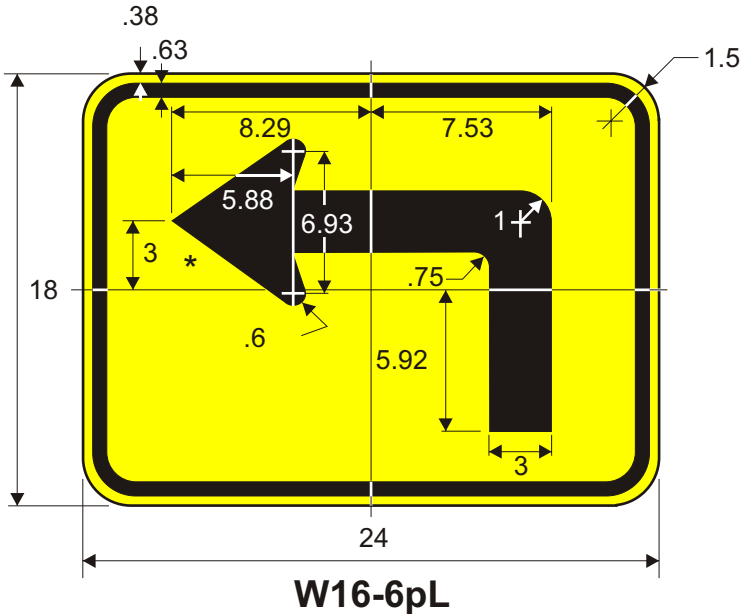

W16-6pL

Border and Legend: Black
Background: Yellow

* See Appendix B-1 for Standard Arrow Details.

W16-7P

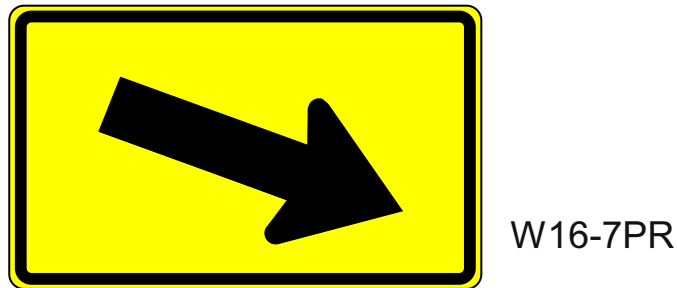
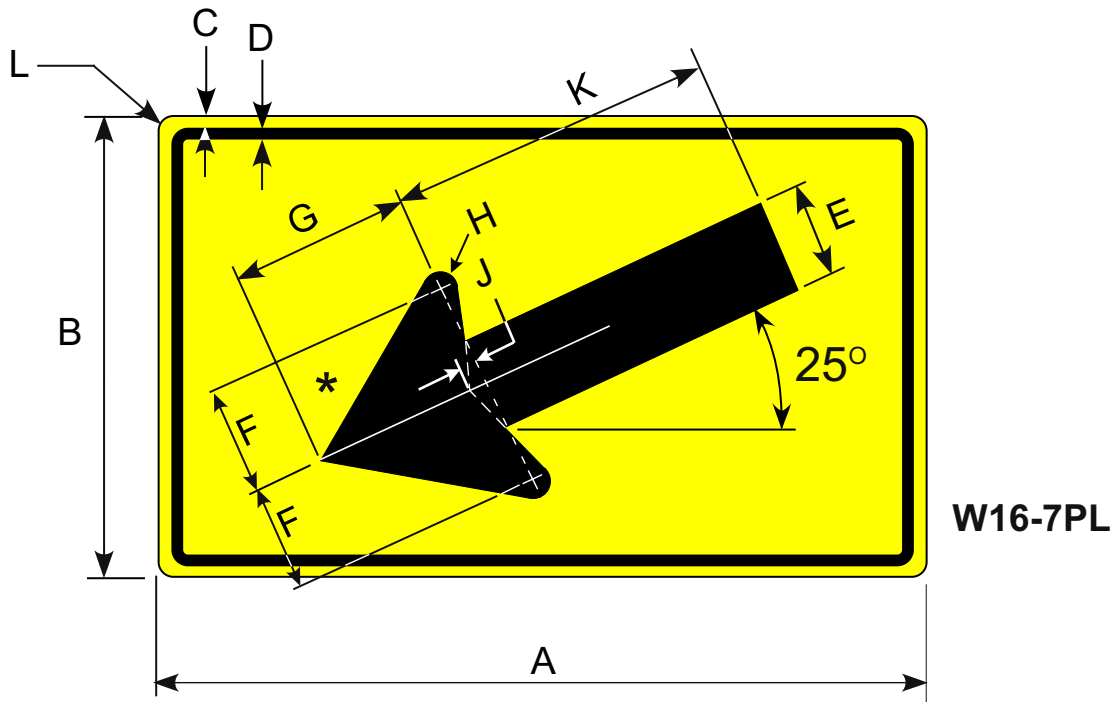

Border and Legend: Black
 Background: Yellow or Florescent Yellow
 Green (match color of supplemented sign)

* See Appendix B-1 for Standard Arrow Details.

Road Class	Dimensions (inches)										
	A	B	C	D	E	F	G	H	J	K	L
Minimum	24	12	0.50	0.50	2.75	3.0	5.56	0.56	0.44	10	1.88
Conver/Expwy	30	18	0.63	0.88	3.5	4.0	7.13	0.69	0.56	13	1.88

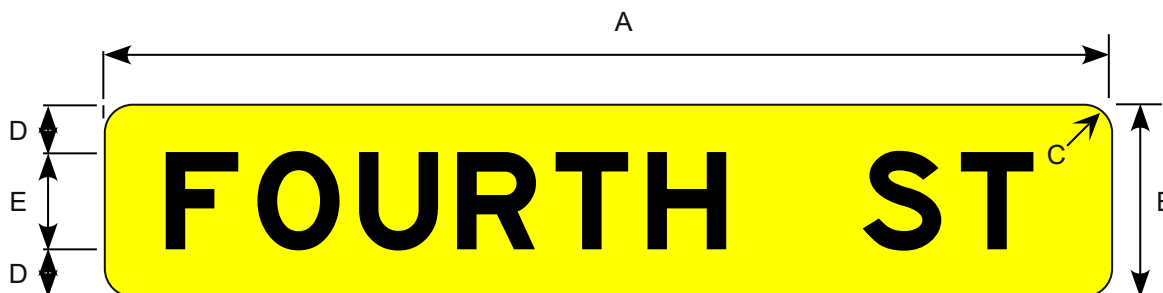

Border and Legend: Black
 Background: Yellow

Road Class	Dimensions (inches)				
	A	B	C	D	E
Conv & Min	VAR	12	1.5	3.5	5C
Expwy	VAR	12	2.0	3.0	6C

W16-9P

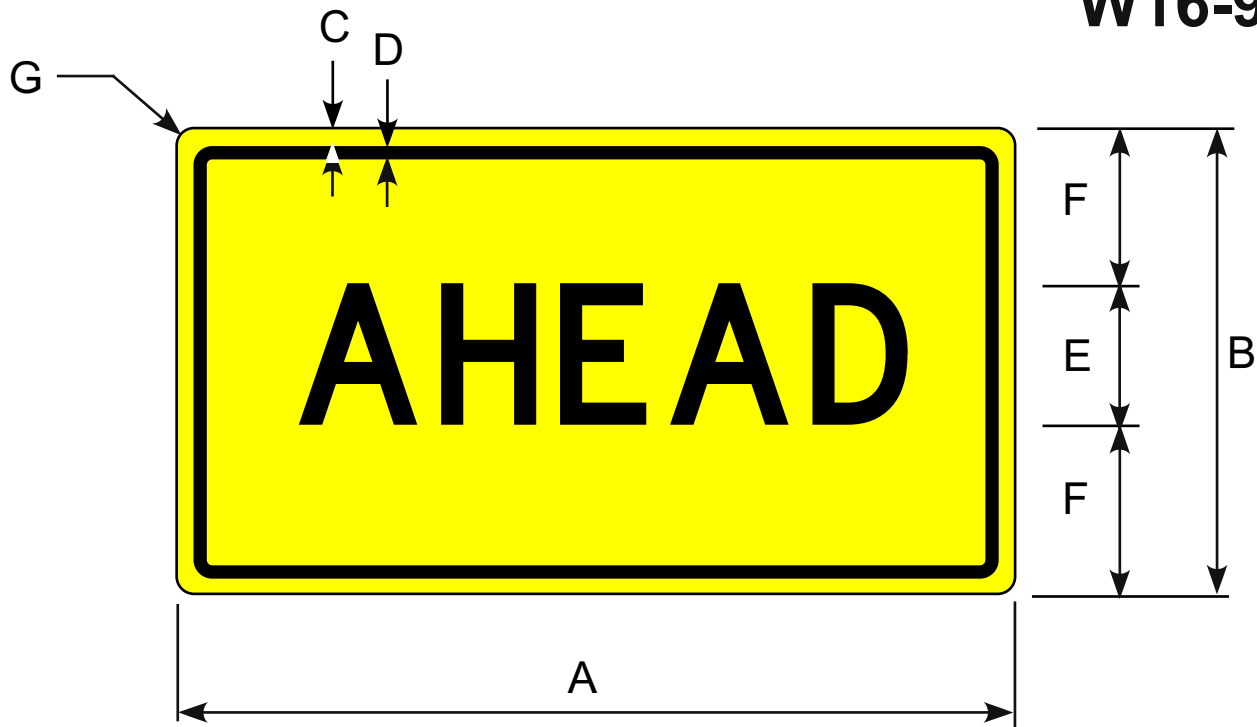

Border and Legend: Black
 Background: Yellow or Orange

Road Class	Dimensions (inches)						
	A	B	C	D	E	F	G
Minimum	24	12	0.50	0.50	4D	4.0	1.88
Conventional	36	18	0.63	0.88	6D	6.0	2.25
Expwy/Fwy	48	30	0.75	1.25	8D	11	3.0

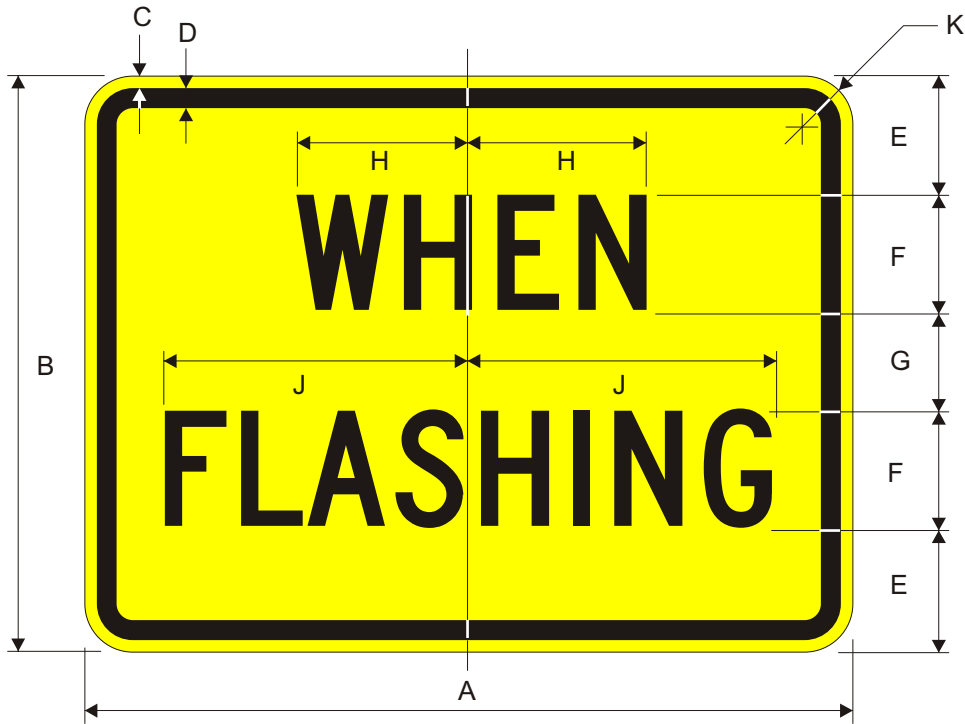

For Use With CW20-7B BE PREPARED TO STOP sign.

Border and Legend: Black
Background: Yellow

Road Class	Dimensions (inches)									
	A	B	C	D	E	F	G	H	J	K
Min	30	24	0.5	0.75	5	5C	3	7.268	12.782	1.875
Conv.	36	30	0.625	0.875	6	6C	6	8.915	16.175	2.25
Expy.	48	36	0.75	1.25	7	8C	6	11.885	21.565	3

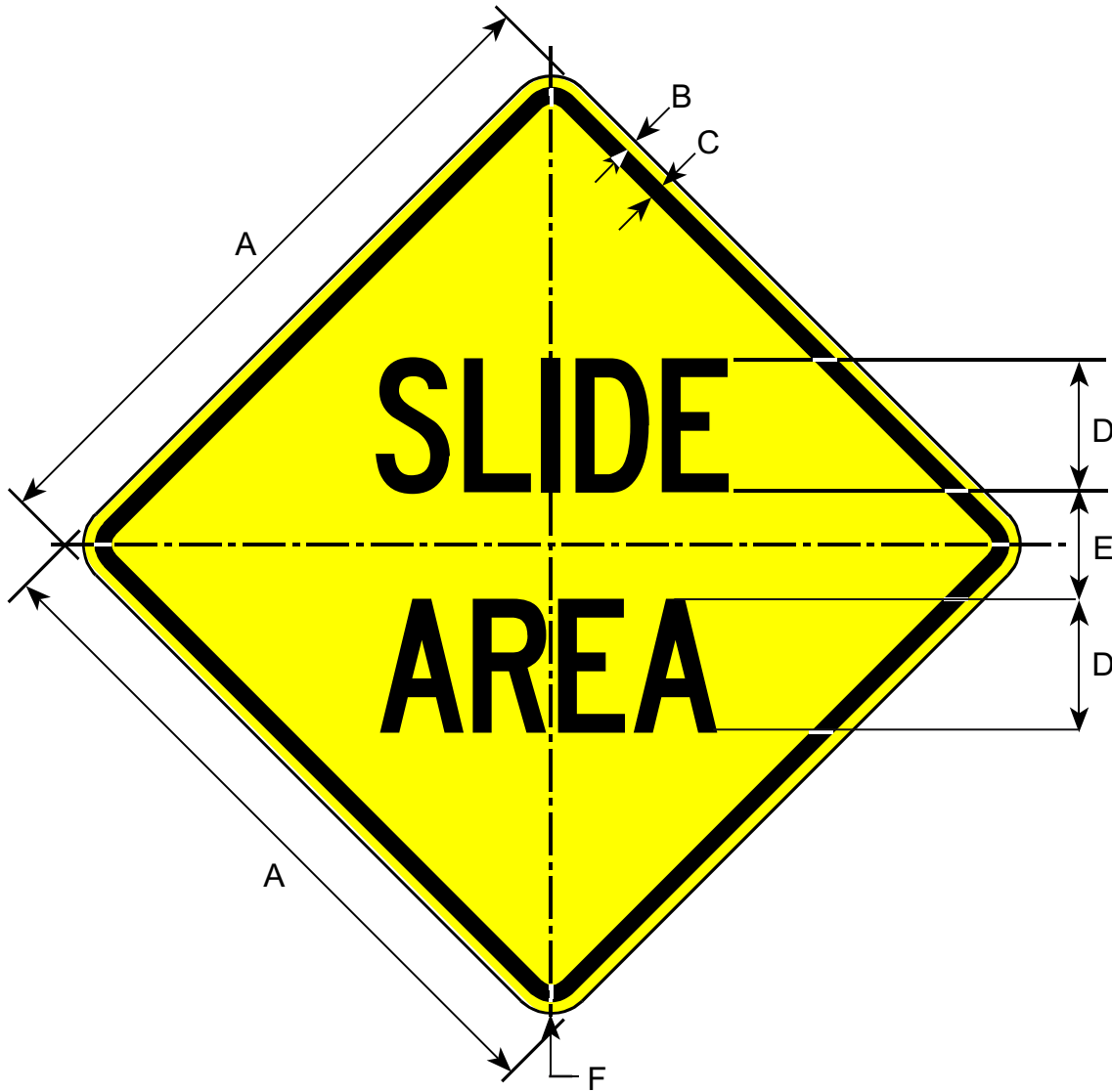

Border and Legend: Black
Background: Yellow

Prior to the 2002 publication of this manual, this sign was numbered W16-1.

Road Class	Dimensions (inches)					
	A	B	C	D	E	F
Minimum	30	0.5	0.75	6D	4.5	1.88
Conventional	36	0.63	0.88	7D	5.5	2.25
Expressway	48	0.75	1.25	10D	7.0	3.00

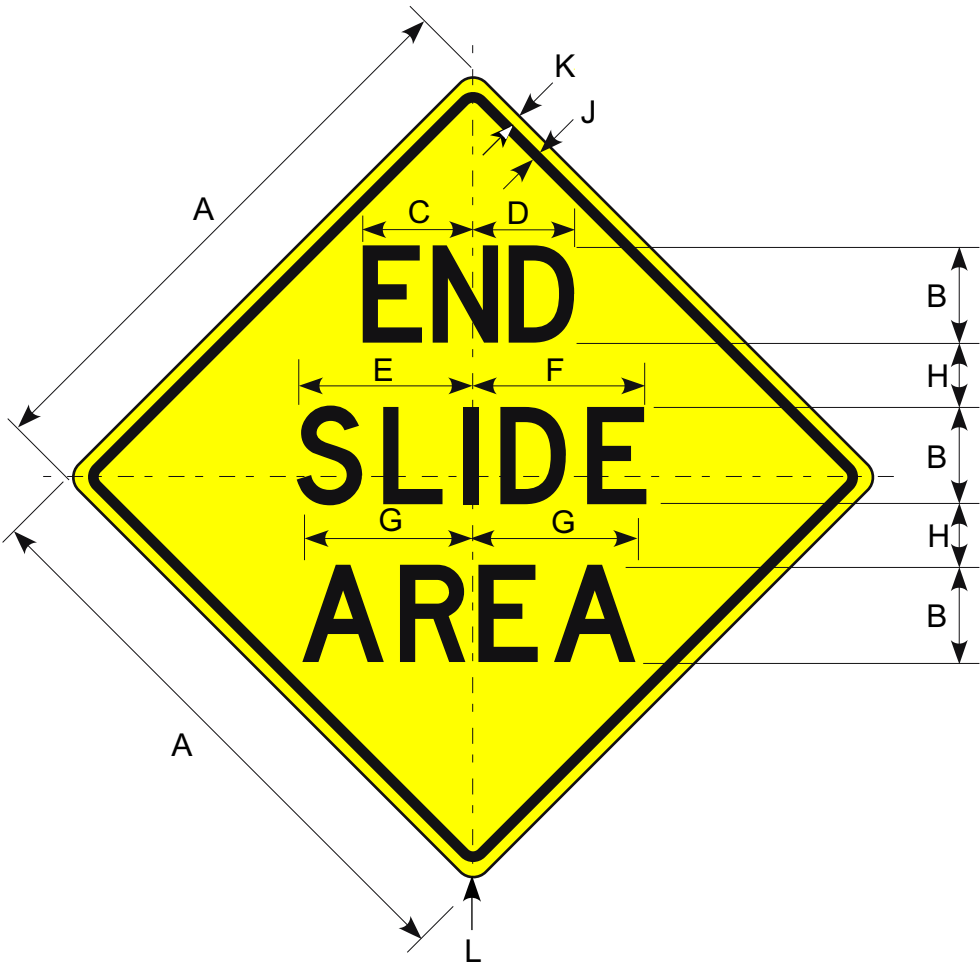

Border and Legend: Black
Background: Yellow

Prior to the 2002 publication of this manual, this sign was numbered W16-2.

Road Class	Dimensions (inches)										
	A	B	C	D	E	F	G	H	J	K	L
Minimum	30	5D	5.75	5.31	9.75	9.50	9.13	3.31	0.75	0.50	1.88
Conventional	36	6D	6.88	6.38	10.88	10.75	10.50	4.00	0.88	0.63	2.25
Expwy/Fwy	48	8D	9.13	8.50	14.81	15.63	14.06	5.31	1.25	0.75	3.00

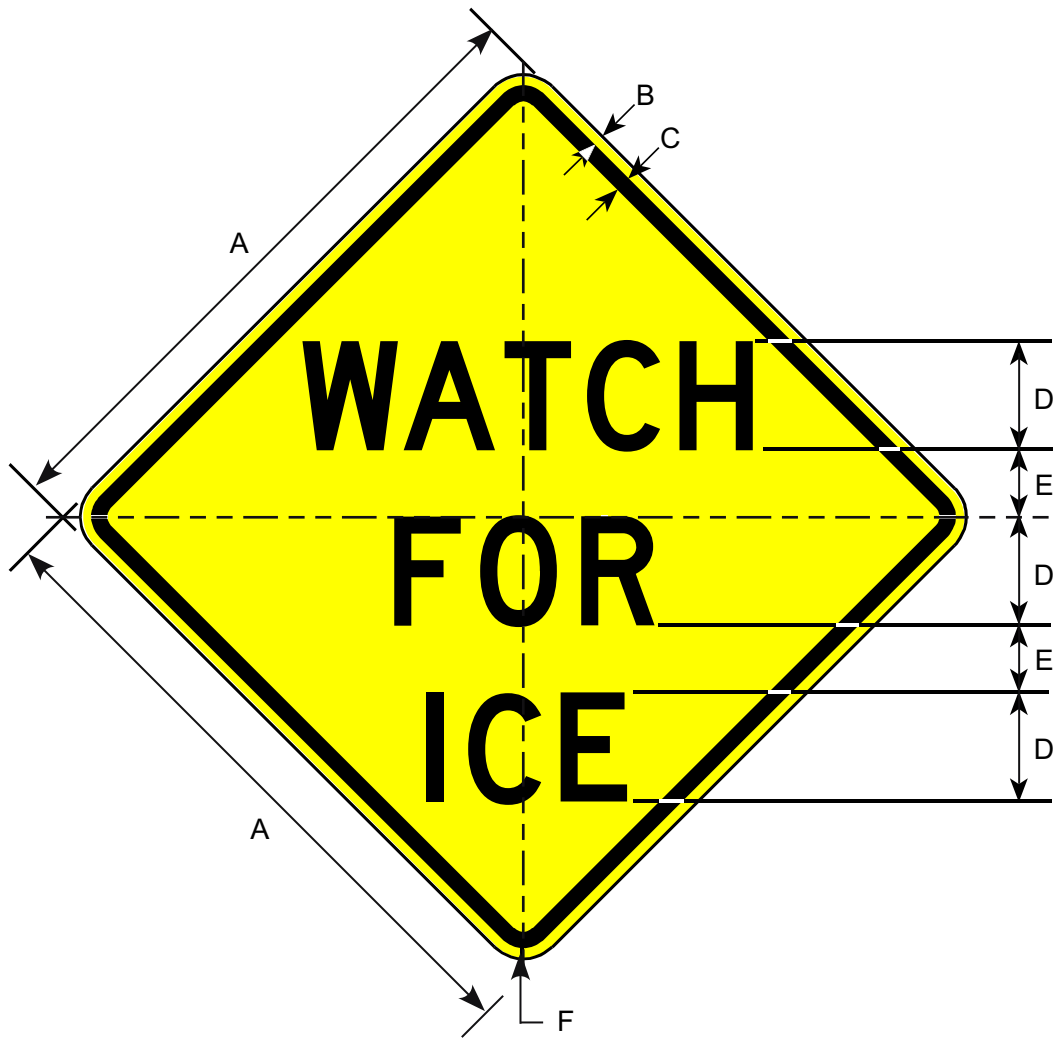

Border and Legend: Black
Background: Yellow

In the 2002 publication of this manual this sign replaced W16-3 ICY.

Road Class	Dimensions (inches)					
	A	B	C	D	E	F
Minimum	30	0.50	0.75	5D	3.00	1.88
Conventional	36	0.63	0.88	6D	4.00	2.25
Expwy/Fwy	48	0.75	1.25	8D	5.25	3.00



Border and Legend: Black
Background: Yellow

In the 2002 publication of this manual this sign replaced two previous signs, W16-4 FLOODED and W16-14 WATER CROSSING.

Road Class	Dimensions (inches)					
	A	B	C	D	E	F
Minimum	30	0.50	0.75	4D	1.25	1.88
Conventional	36	0.63	0.88	5D	1.75	2.25
Expwy/Fwy	48	0.75	1.25	7D	2.25	3.00

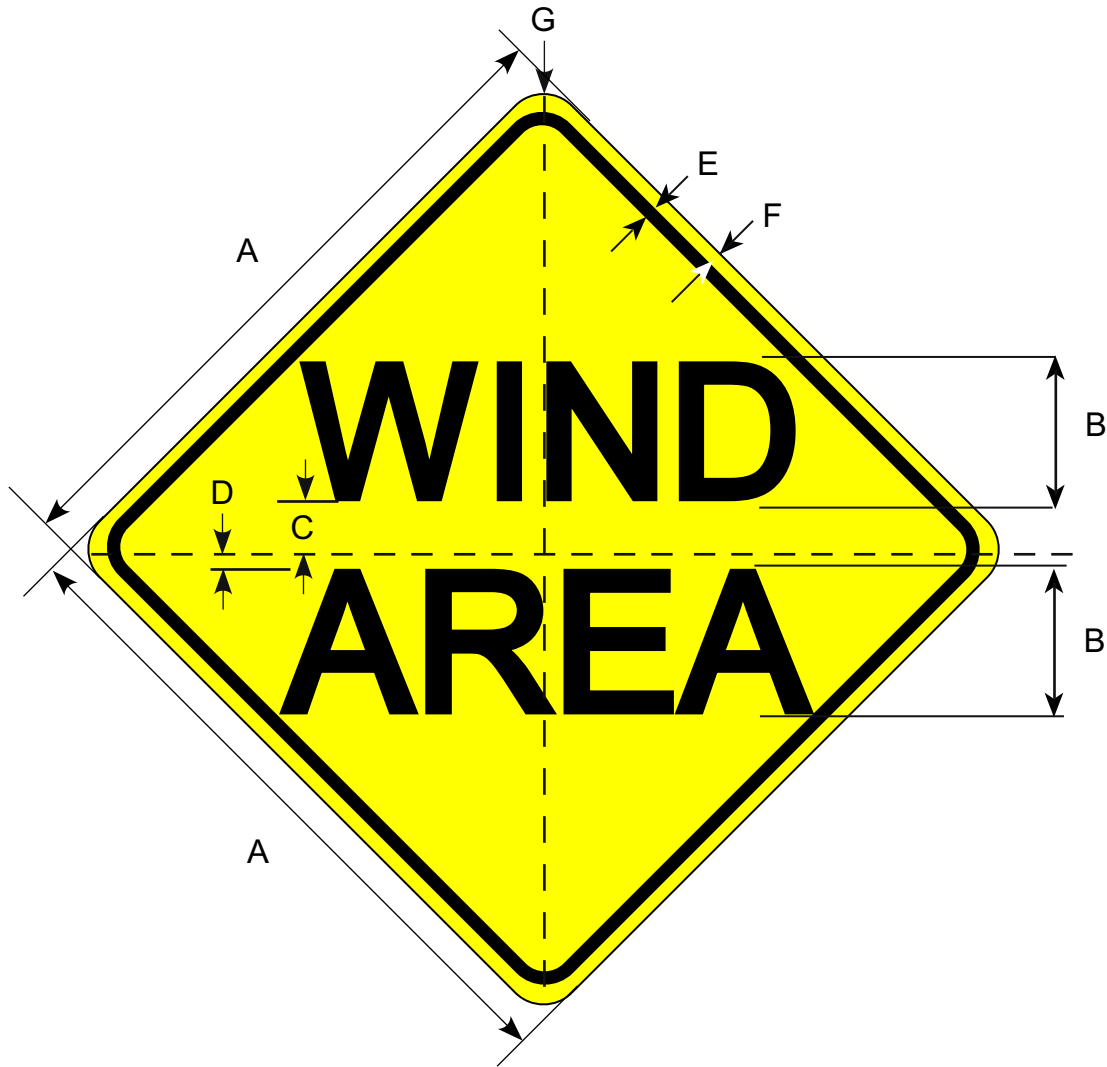

Border and Legend: Black
Background: Yellow

Prior to the 2002 publication of this manual, this sign was numbered W16-7.

Road Class	Dimensions (inches)						
	A	B	C	D	E	F	G
Minimum	30	6D	2.13	0.38	0.75	0.50	1.88
Conventional	36	8D	2.50	0.50	0.88	0.63	2.25
Expwy/Fwy	48	10D	3.00	0.75	1.25	0.75	3.00

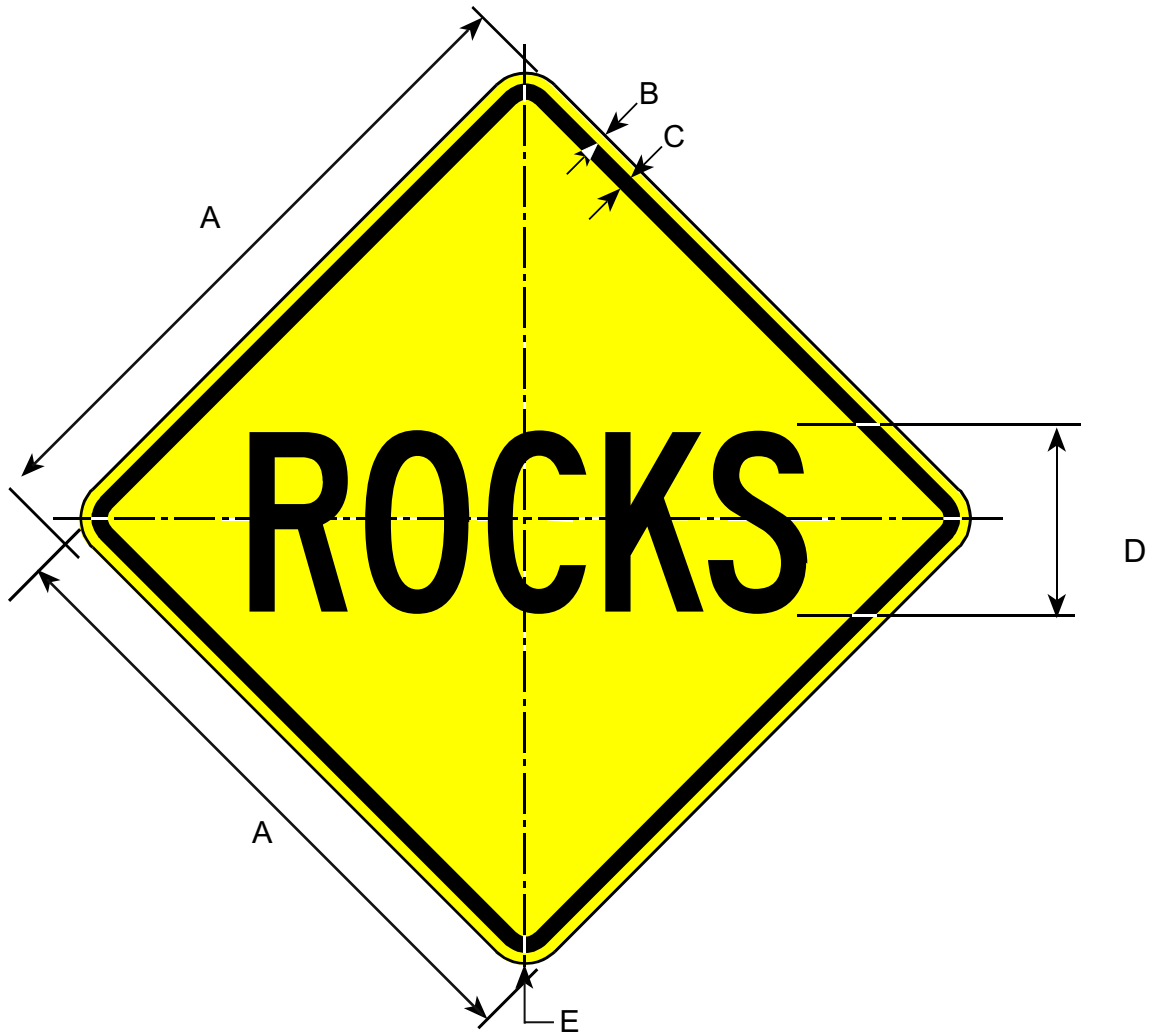

Border and Legend: Black
 Background: Yellow

Prior to the 2002 publication of this manual, this sign was numbered W16-8.

Road Class	Dimensions (inches)				
	A	B	C	D	E
Minimum	30	0.50	0.75	8C	1.88
Conventional	36	0.63	0.88	10C	2.25
Expwy/Fwy	48	0.75	1.25	12C	3.00

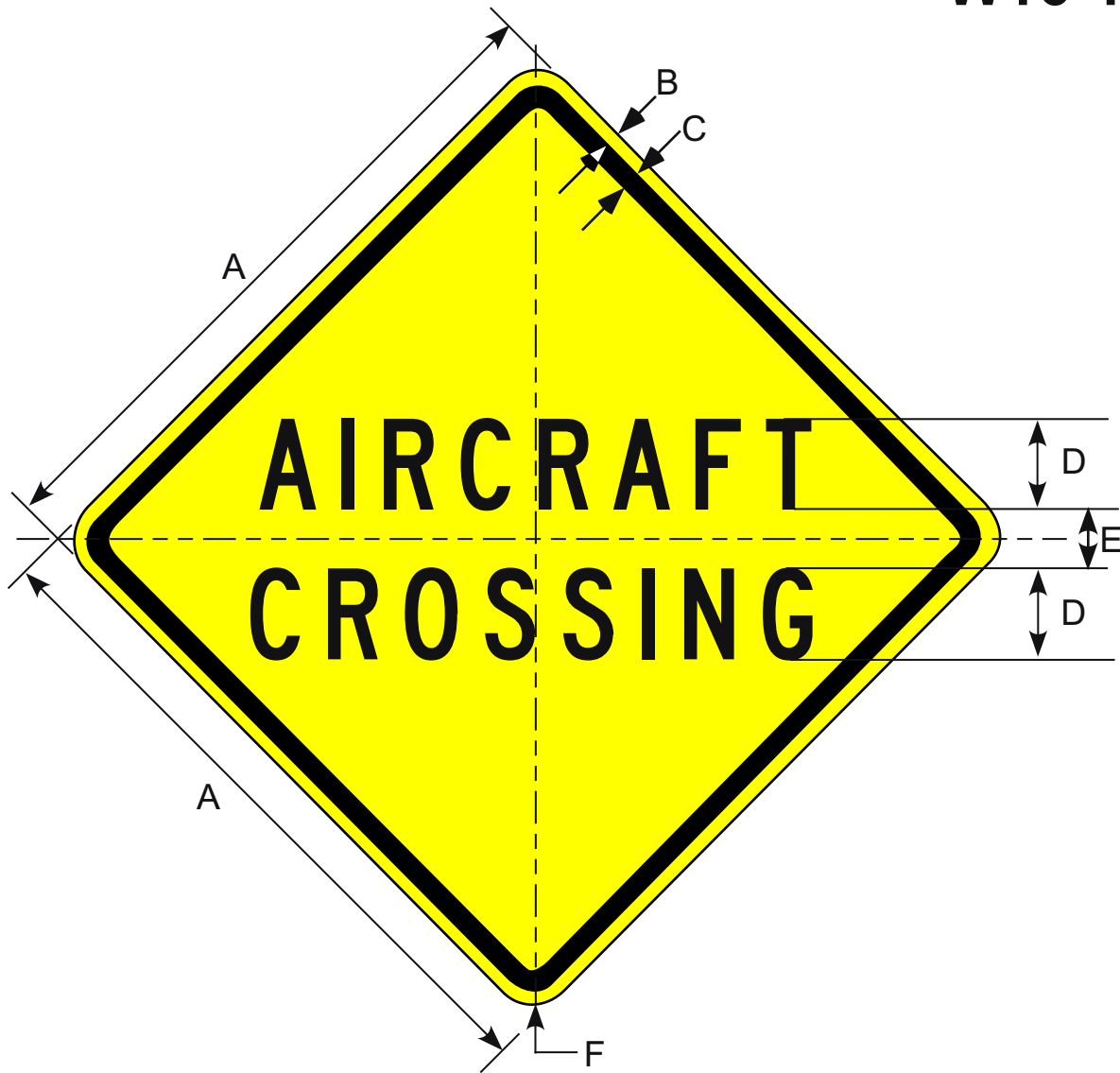

Border and Legend: Black
Background: Yellow

In the 2002 publication of this manual this sign replaced W16-9 AIRCRAFT.

Road Class	Dimensions (inches)					
	A	B	C	D	E	F
Minimum	30	0.50	0.75	4C	3.00	1.88
Conventional	36	0.63	0.88	5C	3.50	2.25
Expwy/Fwy	48	0.75	1.25	7C	4.50	3.00

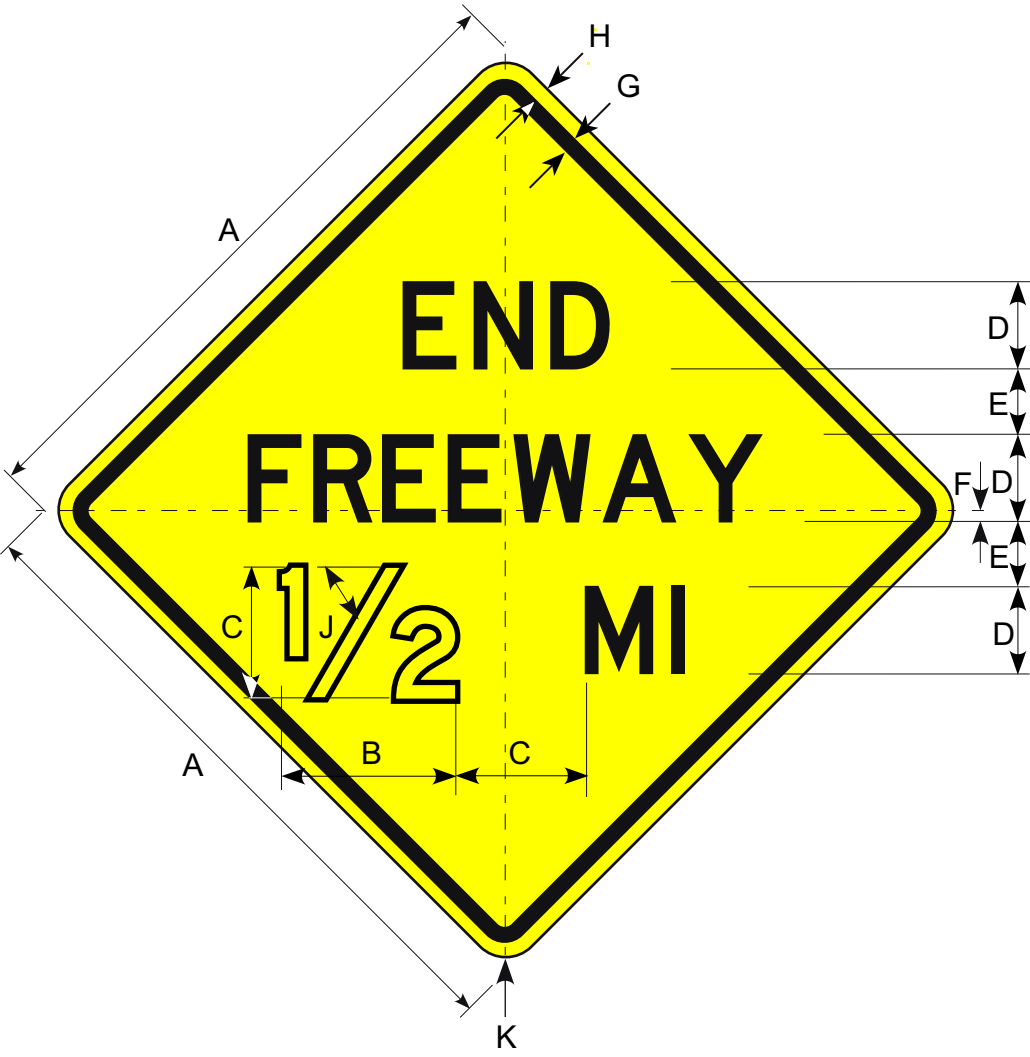

Border and Legend: Black
 Background: Yellow

Prior to the 2002 publication of this manual, this sign was numbered W16-10.

Road Class	Dimensions (inches)									
	A	B	C	D	E	F	G	H	J	K
Expwy/Fwy	60	16	12	8D	6.0	1.0	1.5	1.0	60°	3.75

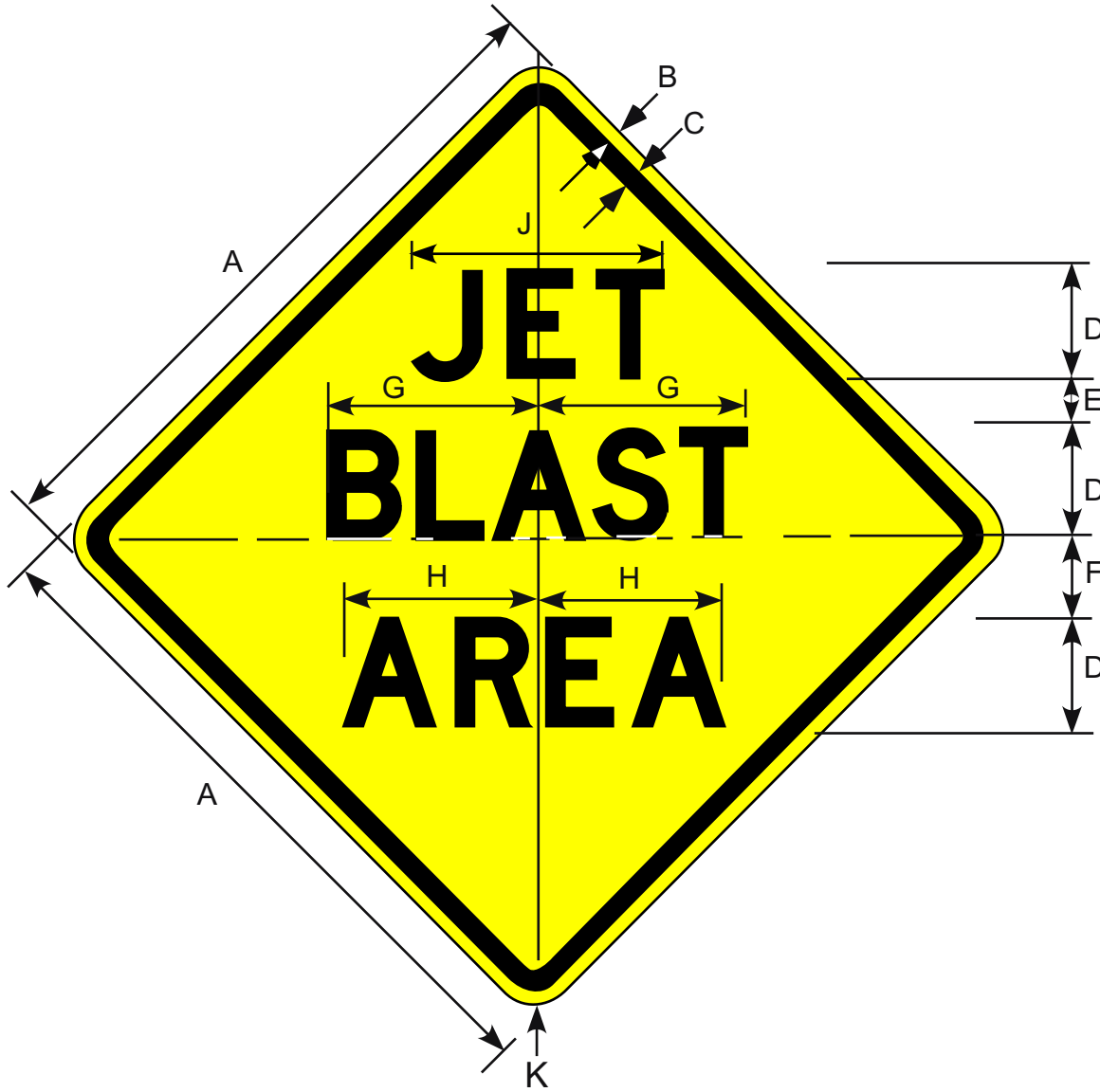

Border and Legend: Black
Background: Yellow

Prior to the 2002 publication of this manual, this sign was numbered W16-12.

Road Class	Dimensions (inches)									
	A	B	C	D	E	F	G	H	J	K
Minimum	30	0.50	0.75	5C	3.3	5.0	13.25	7.50	9.11	1.88
Conventional	36	0.63	0.88	6C	4.0	6.0	16	8.38	17.51	2.25
Expwy/Fwy	48	0.75	1.25	8C	6.0	8.0	21.25	11.13	13.94	3.0

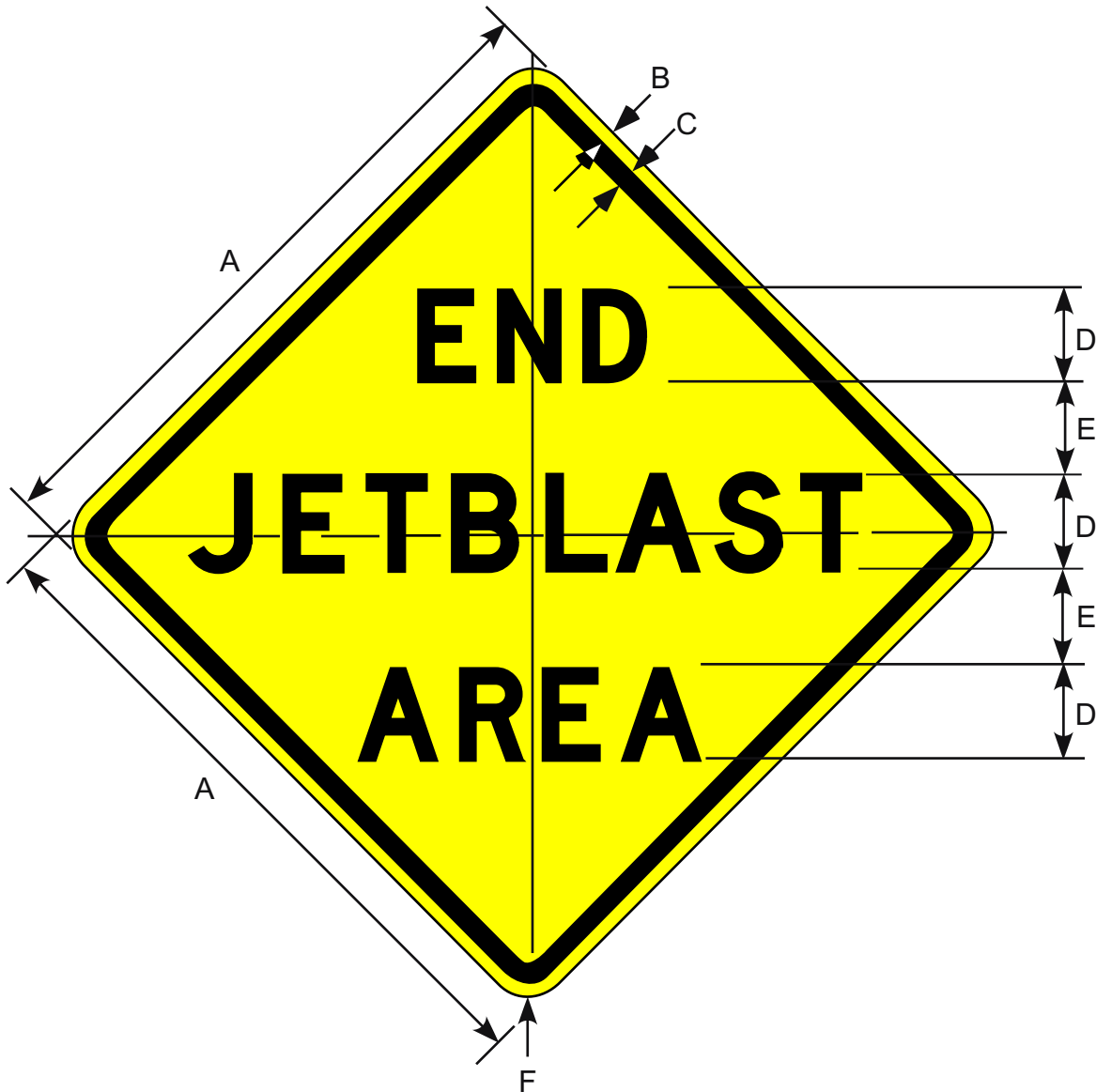

Prior to the 2002 publication of this manual, this sign was numbered W16-13.

Border and Legend: Black
Background: Yellow

Road Class	Dimensions (inches)					
	A	B	C	D	E	F
Minimum	30	0.50	0.75	5C	5.0	1.88
Conventional	36	0.63	0.88	6C	6.0	2.25
Expwy/Fwy	48	0.75	1.25	8C	8.0	3.0

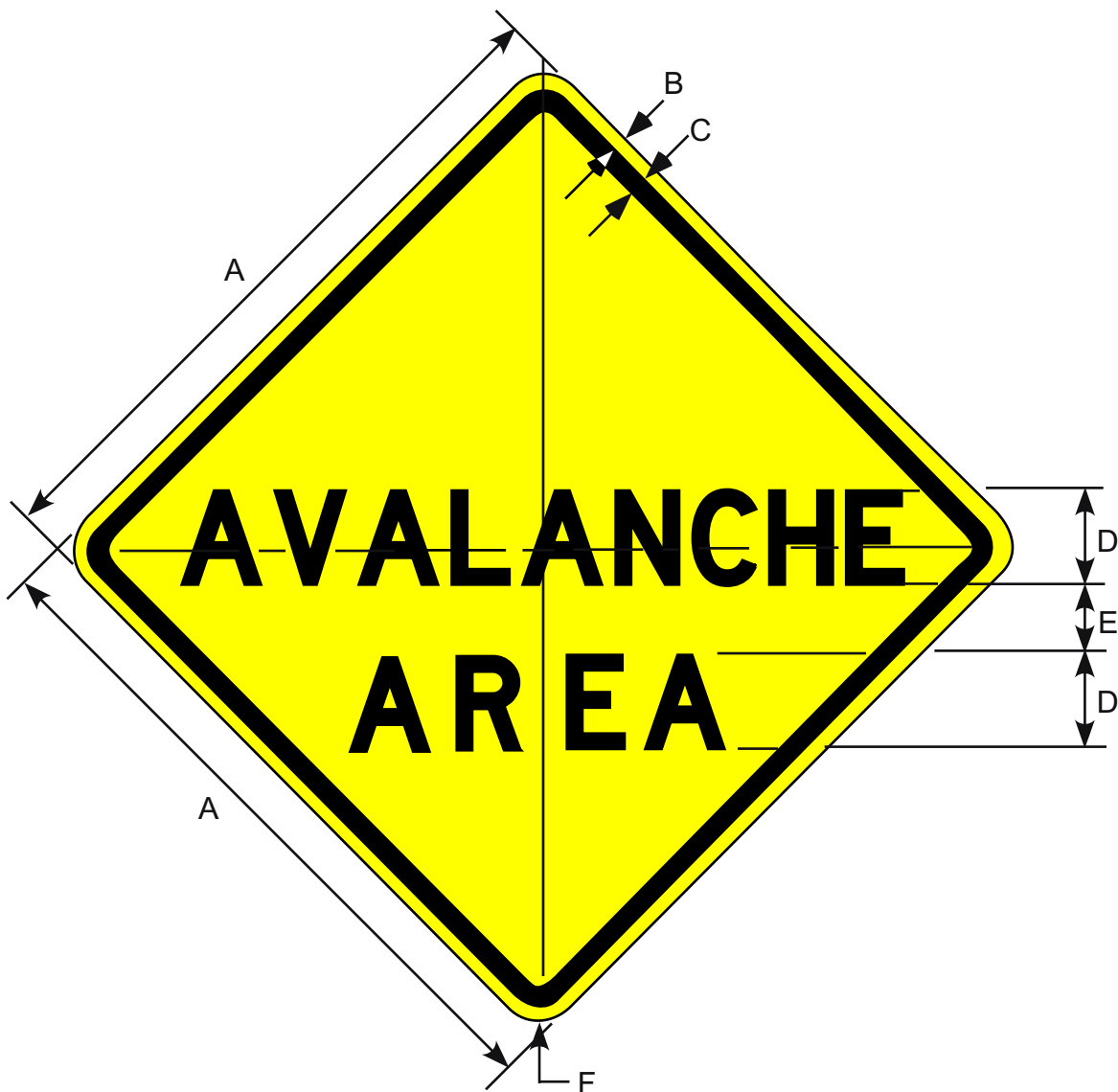

Prior to the 2002 publication of this manual, this sign was numbered W16-5.

Border and Legend: Black
Background: Yellow

Road Class	Dimensions (inches)					
	A	B	C	D	E	F
Minimum	30	0.50	0.75	5C	3.5	1.88
Conventional	36	0.63	0.88	6C	4.0	2.25
Expwy/Fwy	48	0.75	1.25	8C	5.38	3.0

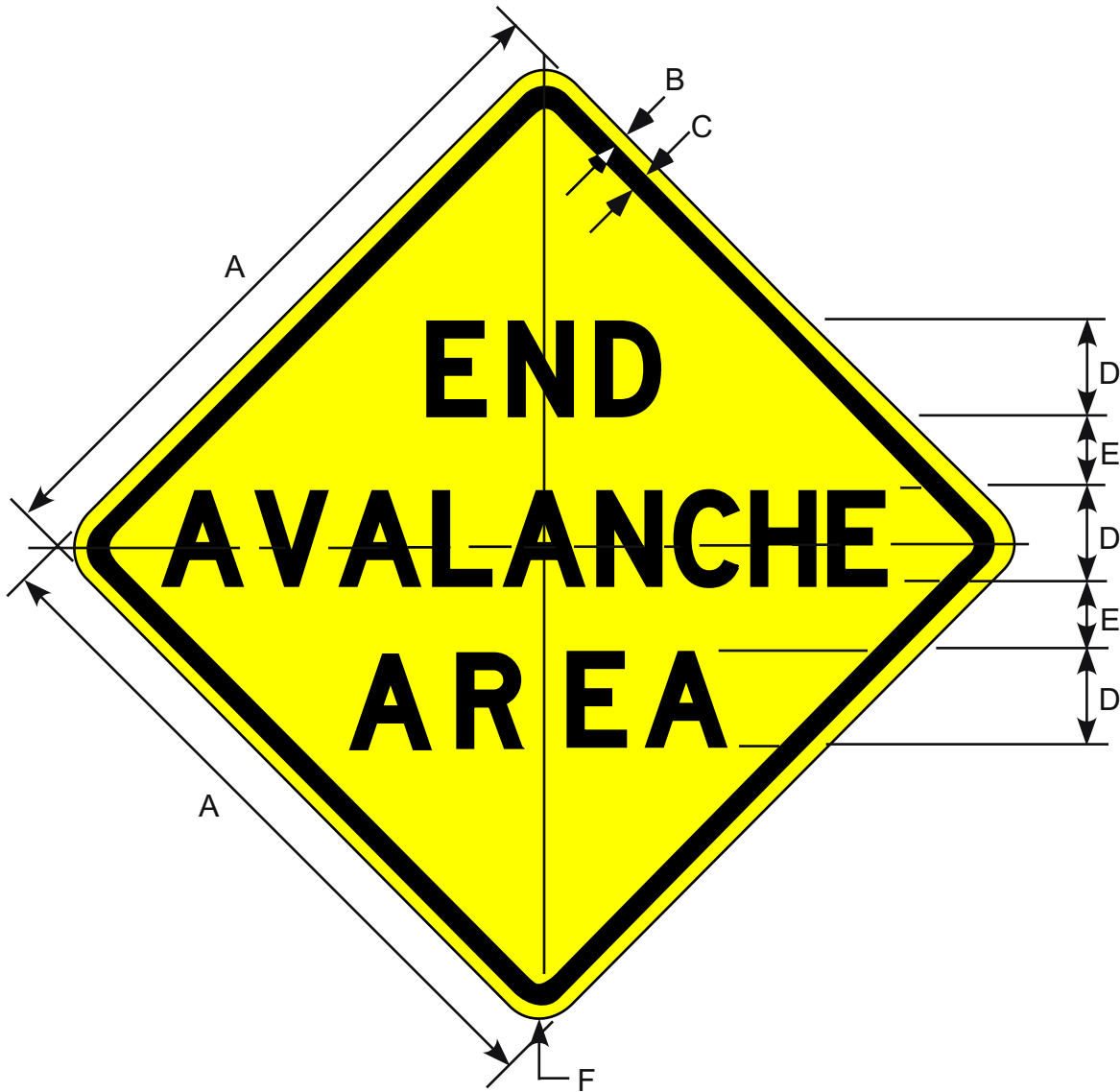

Prior to the 2002 publication of this manual, this sign was numbered W16-6.

Border and Legend: Black
Background: Yellow

Road Class	Dimensions (inches)					
	A	B	C	D	E	F
Minimum	30	0.50	0.75	5C	3.0	1.88
Conventional	36	0.63	0.88	6C	4.0	2.25
Expwy/Fwy	48	0.75	1.25	8C	5.25	3.0



Border and Legend: Black
 Background Top: Yellow
 Background Bottom: White

Road Class	Dimensions (inches)								
	A	B	C	D	E	F	G	H	J
Expwy/Fwy	90	48	0.75	1.25	5	8C	9	18	6



Border and Legend: Black
Background: Yellow

Road Class	Dimensions (inches)							
	A	B	C	D	E	F	G	H
Min & Conv	30	36	0.5	0.75	4D	3	3	1.88

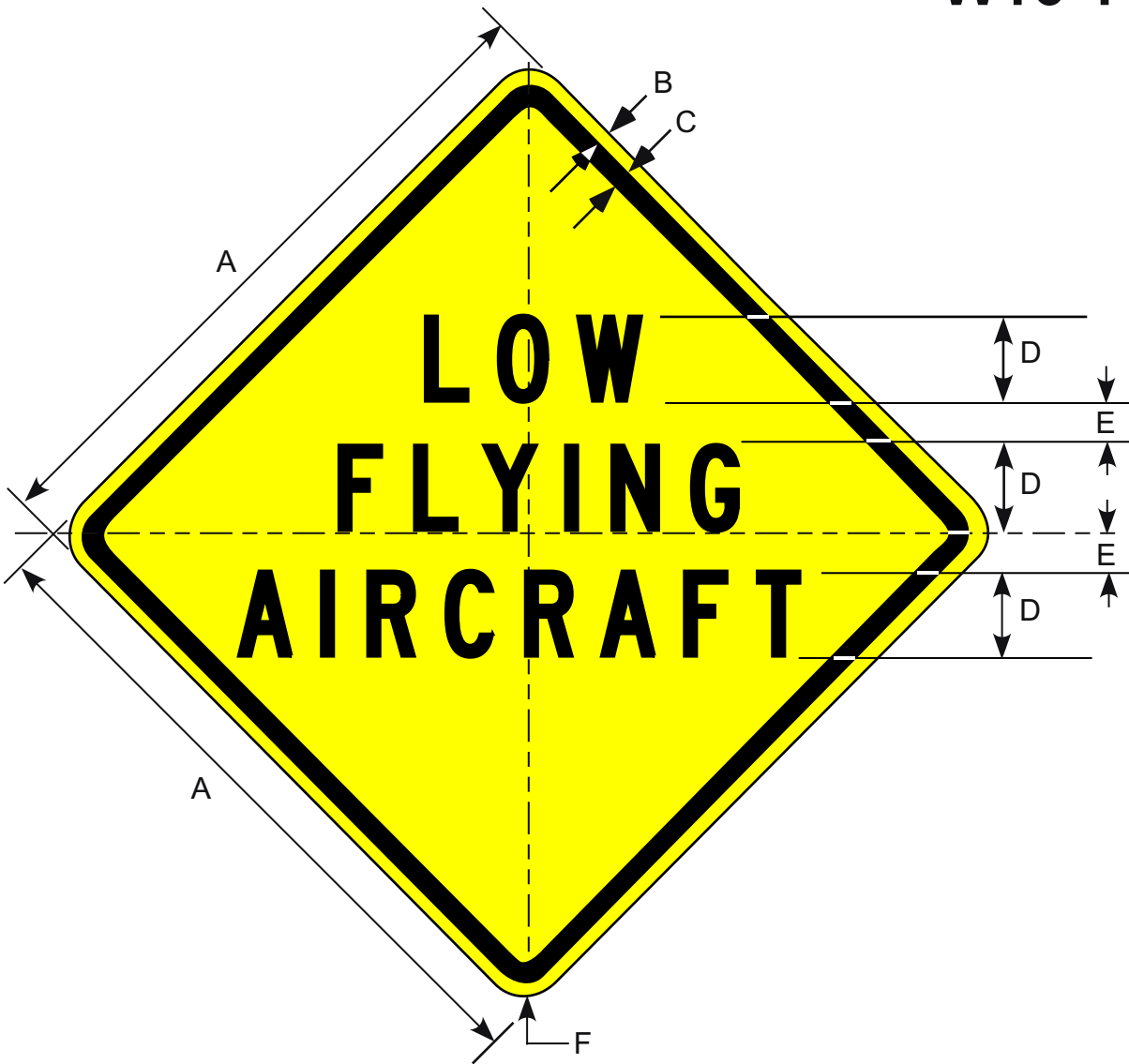

Border and Legend: Black
Background: Yellow

Road Class	Dimensions (inches)					
	A	B	C	D	E	F
Minimum	30	0.50	0.75	5C	2.5	1.88
Conventional	36	0.63	0.88	6C	2.75	2.25
Expwy/Fwy	48	0.75	1.25	8C	3.5	3.0

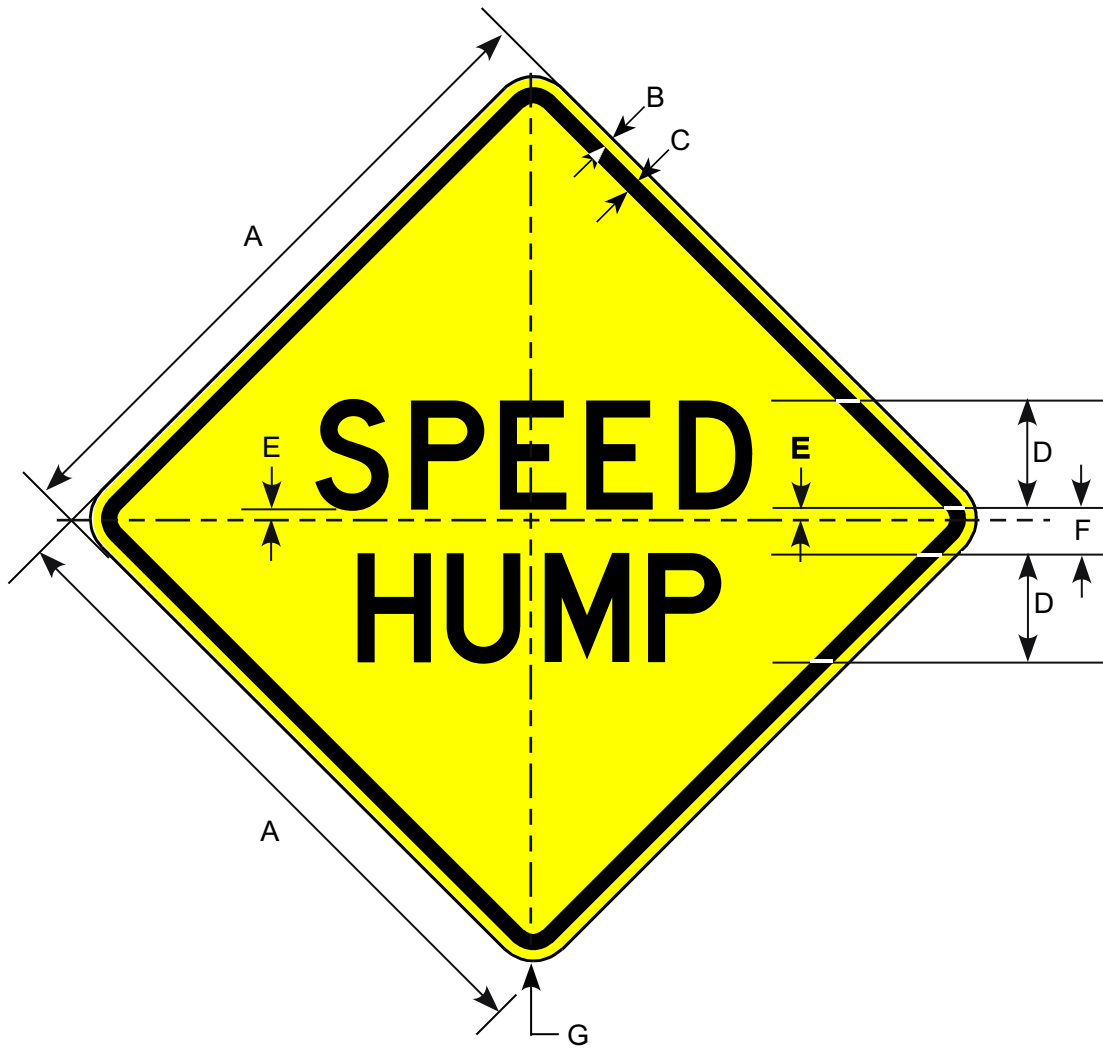

Border and Legend: Black
 Background: Yellow

Road Class	Dimensions (inches)						
	A	B	C	D	E	F	G
Minimum	30	0.50	0.75	5D	0.48	2.56	1.88
Conventional	36	0.63	0.88	6D	0.76	3.00	2.25



Border and Legend: Black
Background: Yellow



Border and Legend: Black
 Background: Yellow

APPENDIX A

A-1 to A-5

Appendix A. Design of Guide (D1, D2, D3, and E) Signs

Determine sign, letter, number, space, symbol, border, and margin dimensions and arrangement as follows:

1) Size letters, numbers, symbols, and arrows.

- a) Size letters, numbers, and intervening spaces in accordance with Appendix C.
 - i) Unless otherwise noted on sign drawings, use the Clearview 5-W typeface for all letters and numbers, unless it is critical to minimize sign width, in which case use Clearview 5-W-R.
 - ii) Do not use periods for the standard abbreviations listed in section 11 of this appendix.
 - iii) When ordinal number street names are given in symbol form (e.g. 100th), use lowercase lettering for the alpha ending.
- b) Size arrows in accordance with Appendix B.
- c) Size symbols as shown on sign drawings. Symbols may be cut from the Adobe Acrobat sign layouts available on the Internet and scaled as required for each sign.

2) Size Fractions

- a) Treat fractions as a unit and not as separate characters. This unit is called the "fraction rectangle," which consists of the numerals and diagonal.
- b) The width of the fraction rectangle is 2.5 times the fraction numeral height, except when the upper numeral is "1", in which case its width is 2 times the numeral height.
- c) The height of the fraction rectangle is 1.5 times the uppercase letter height.
- d) Set the bottom of the fraction rectangle 0.25 times the uppercase letter height below the baseline (the line on which the non-fraction numbers or text rest).
- e) The diagonal length is 1.7 times the fraction numeral height; its width is equal to the stroke width of the numeral and is mounted at an angle of 60° from the horizontal.

Appendix A. Guide (D1, D2, D3, and E) Sign Layout

3) Determine spacing between words, arrows, fractions, and symbols.

- a) Set the space between words, a word and an arrow, and a number and an arrow equal to the upper-case letter height. If the heights of neighboring words or numbers differ, use the average height.
- b) Set the space between a word and number at 1.5 times the upper-case letter height. If the heights of neighboring words and numbers differ, use the average height.
- c) Set the space between a fraction rectangle and a preceding or following letter at the fraction numeral height.
- d) In cases where it is necessary to reduce sign size, you may reduce inter-character spacing, but not to less than $2/3$ of these values.

4) Determine sign height and width.

- a) Height
 - i) Sign height and vertical spaces are usually specified on sign drawings. If not, size as follows:
 - (1) Set vertical spaces between lines equal to the height of upper case letters in the upper line plus the height of upper case letters in the lower line divided by two.
 - (2) Set vertical spaces between a line and the edge of sign equal to the height of upper case letters in the line.
 - (3) Add the spaces and letter heights for all lines on the sign.
 - (4) Round off to the nearest (usually) 6-inch increment. Use judgment when rounding down to ensure adequate clearances and separations (don't reduce to less than $2/3$ of values given).
 - (5) Distribute the change to height that results from rounding proportionally to all vertical spaces.
- b) Width
 - i) Determine the width of the widest legend on the sign in accordance with 1), 2), and 3) above.
 - ii) Add spaces between the sign message and the left and right edges of the sign equal to the upper-case letter height.
 - iii) Round to the nearest 6-inch increment. This is the final width.

Appendix A. Design of Guide (D1, D2, D3, and E) Signs

5) Arrange Lines in Order on Multi-Line Signs

- a) On signs with arrows, arrange destinations from top to bottom by arrow type in the order shown below, locating the arrow near the sign edge indicated.

Arrow type	Priority	Location
Vertical Arrow	1	Left
Advance Left Arrow	2	Left
Diagonal Left Arrow	3	Left
Horizontal Left Arrow	4	Left
Diagonal Right Arrow	5	Right
Horizontal Right Arrow	6	Right

- b) On mileage signs without arrows, arrange destinations from top to bottom by distance, the nearest at the top, the farthest at the bottom.
- c) On signs with both mileage and arrows, arrange in arrow-type priority.
- d) When a single arrow indicates the direction to two destinations, the nearest destination should be listed on top.

6) Group and Separate Destinations in Different Directions On Multi-line Signs with Arrows

- a) Add a white horizontal line equal in width to the sign's border between destinations in different directions. This is necessary to avoid drivers associating an arrow on one line with a destination on another (a surprisingly common occurrence). Provide the additional height necessary to accommodate the line.

When two destinations lie in the same direction, use a single two-line arrow vertically centered between the lines.

7) Locate Messages Horizontally

- a) On the widest line on a sign, determine the final offset between the message and the left and right sign edges (the “edge offset”) by subtracting the legend width from the final sign width and dividing by two.
- b) On shorter lines, arrange content as follows:
- Lines that consist of a complete name only: center the message and let the edge offsets vary.
 - Lines that consist of a complete name and an arrow:

Appendix A. Guide (D1, D2, D3, and E) Sign Layout

- (1) Set the arrow at the edge offset of the widest line from the near edge.
 - (2) Offset the name from the arrow by the amount specified under 3) above.
 - (3) To present a neat appearance, make minor adjustments to line up the edge of text nearest the arrow with the edges of text of lines above and below that have arrows on the same side of the sign. This does not apply to lines with two-line arrows.
- iii) Lines that consist of part of a name (because the name is too long for one line): set the left edge offset equal to the one on the widest line and let the right edge offset vary.
- iv) Lines that consist of a word and a number:
- (1) set the left and right edge offsets equal to those of the widest line
 - (2) let the space between the word and number vary.
- v) Lines that consist of a word, number, and an arrow:
- (1) set the left and right edge offsets equal to those of the widest line.
 - (2) let the space between the word and number vary.
 - (3) left-justify words to the right of the arrows whenever possible.
- vi) Lines with two destinations per arrow. When two destinations lie in the same direction, use a single two-line arrow, and arrange lines of legend as follows:
- (1) When one of the lines, with the arrow, is the widest line on the sign, arrange it in accordance with the instructions for the widest lines in 7)a).
 - (2) Arrange shorter lines as follows:
 - (a) Lines that consist of a word and a number:
 - (i) On the arrow side of the sign, offset the word or number from the arrow in accordance with 3).
 - (ii) On the other side of the sign, set the word or number at an edge offset equal to that on the widest line.
 - (iii) Let the space between the word and number vary.
 - (b) Lines that consist of a word only:
 - (i) On the arrow side of the sign, offset the word or number from the arrow in accordance with 3).
 - (ii) Let the other edge offset vary.

Appendix A. Design of Guide (D1, D2, D3, and E) Signs

- c) Locate symbols and adjacent text as shown on sign drawings.

8) Determine Corner Radius

- a) Round the corners of all destination signs. If corner radius is not specified on sign drawings, use a radius approximating 1/16 of sign height or width; whichever is less, to a maximum of four inches.

9) Determine Border Width

- a) Place borders on all destination signs. Locate so the edge of the border coincides with the edge of sign. If border width is not specified on sign drawings, use the following width:

<u>Largest Letter Size Used</u>	<u>Border Width</u>
6" Caps	0.75"
6" Uppercase or 8" Caps	$0.50" + 0.25(*N-1)$
8" Uppercase or 10" Caps	$0.75" + 0.25(*N-1)$
10.7" Uppercase or 12" Caps	$1.00" + 0.25(*N-1)$
13.3" Uppercase or 15" Caps	$1.25" + 0.25(*N-1)$
16" Uppercase or 18" Caps	2"
20" Uppercase	3"

**N = Number of lines of legend*

10) Miscellaneous

- a) If no angle is specified, set the centerline of diagonal arrows on a 45-degree angle.

11) Standard Abbreviations.

The abbreviations listed in Table 1A-1 and 1A-2 of the 2003 Manual on Uniform Traffic Control Devices may be used to minimize sign length.

APPENDIX B

B-1 to B-5

Appendix B. Arrows

Standard Arrow Details

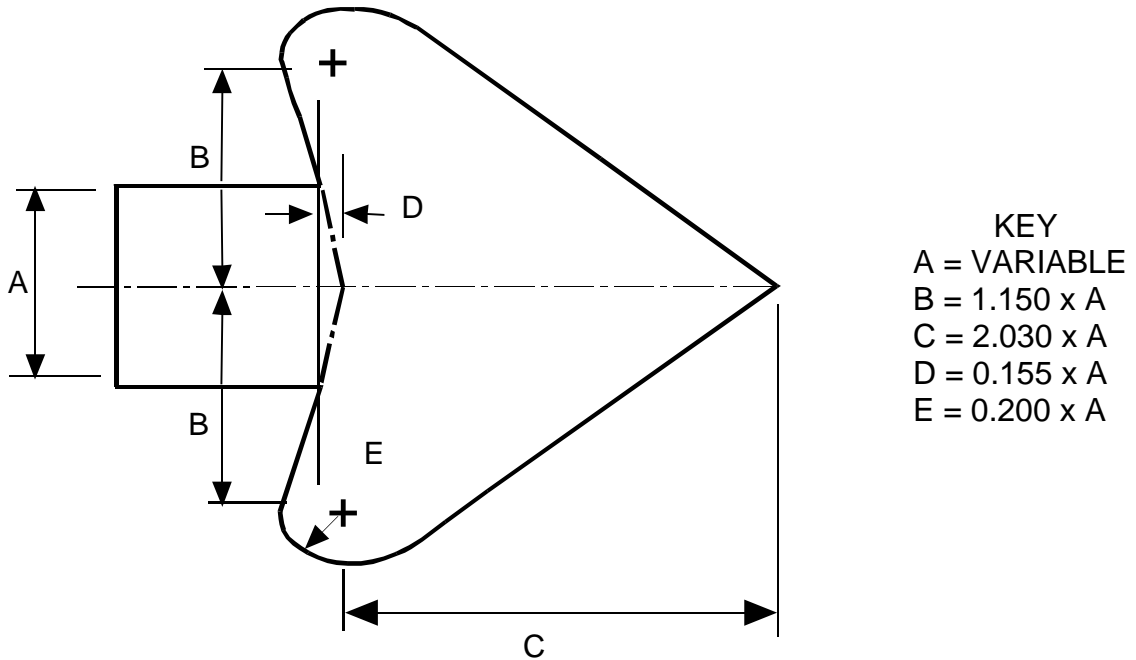

Dimensions (inches)

A	B	C	D	E	A	B	C	D	E
0.75	0.86	1.52	0.12	0.15	4.00	4.60	8.12	0.62	0.80
1.00	1.15	2.03	0.16	0.20	4.06	4.67	8.25	0.63	0.81
1.25	1.44	2.54	0.19	0.25	4.25	4.89	8.63	0.66	0.85
1.50	1.73	3.05	0.23	0.30	4.38	5.03	8.88	0.68	0.88
1.63	1.87	3.30	0.25	0.33	4.50	5.18	9.14	0.70	0.90
1.75	2.01	3.55	0.27	0.35	4.75	5.46	9.64	0.74	0.95
2.00	2.30	4.06	0.31	0.40	4.88	5.61	9.90	0.76	0.98
2.25	2.59	4.57	0.35	0.45	5.00	5.75	10.15	0.78	1.00
2.50	2.88	5.08	0.39	0.50	5.25	6.04	10.66	0.81	1.05
2.63	3.02	5.33	0.41	0.53	5.50	6.33	11.17	0.85	1.10
2.75	3.16	5.58	0.43	0.55	5.75	6.61	11.67	0.89	1.15
3.00	3.45	6.09	0.47	0.60	6.00	6.90	12.18	0.93	1.20
3.13	3.59	6.34	0.48	0.63	6.50	7.48	13.20	1.01	1.30
3.25	3.74	6.60	0.50	0.65	7.00	8.05	14.21	1.09	1.40
3.31	3.81	6.73	0.51	0.66	7.50	8.63	15.23	1.16	1.50
3.50	4.03	7.11	0.54	0.70	8.00	9.20	16.24	1.24	1.60
3.75	4.31	7.61	0.58	0.75					

Guide Sign Up Arrow

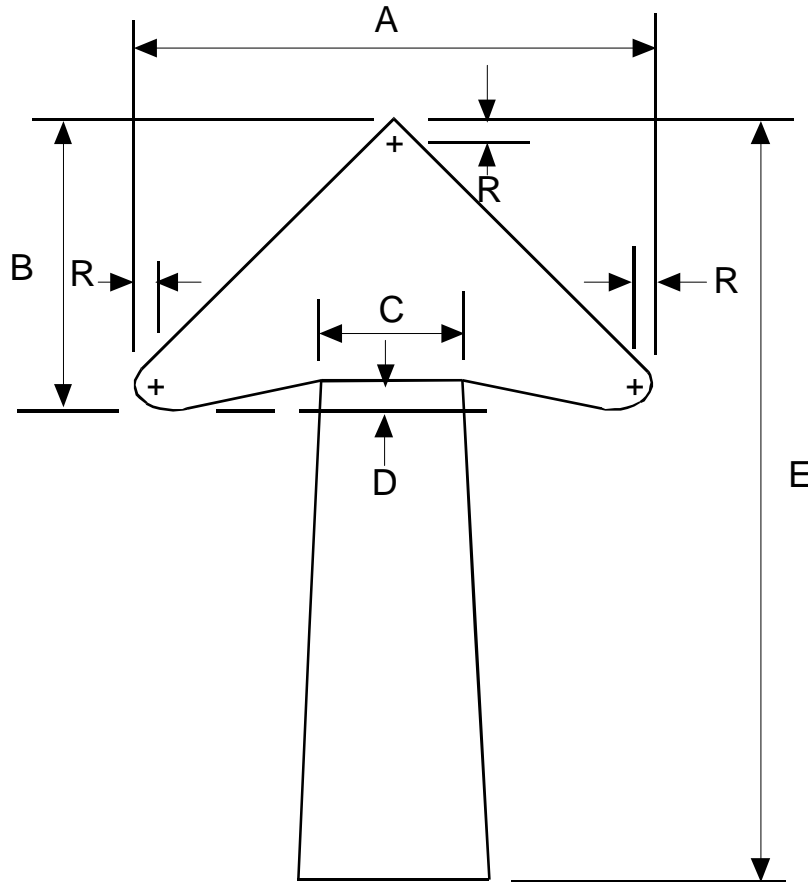

DIMENSIONS (INCHES)								
ARROW NO.	LETTER SIZE(U.C.)	LINES OF COPY	ARROW DIMENSIONS IN INCHES					
			A	B	C	D	*E	R
1	8" U.C. OR 8" CAPS.	1	11	8 1/2	2 3/4	7/8	13	1/2
2	8" CAPS.	2	11	8 1/2	2 3/4	7/8	18	1/2
3	10.67" - 13.33" U.C.	1	18 1/4	14	4 1/2	1 1/2	20	3/4
4	OR 10" CAPS.	2	18 1/4	14	4 1/2	1 1/2	30	3/4
5	16" U.C. OR 12" CAPS.	1	22 1/4	17	5 3/8	1 3/4	25	1
6	12" CAPS.	2	22 1/4	17	5 3/8	1 3/4	35	1

TAPER OF 1/2" PER FOOT SHALL BE HELD CONSTANT FOR LONGER OR SHORTER SHAFT LENGTHS.

Appendix B. Arrows

Guide Sign Down Arrow

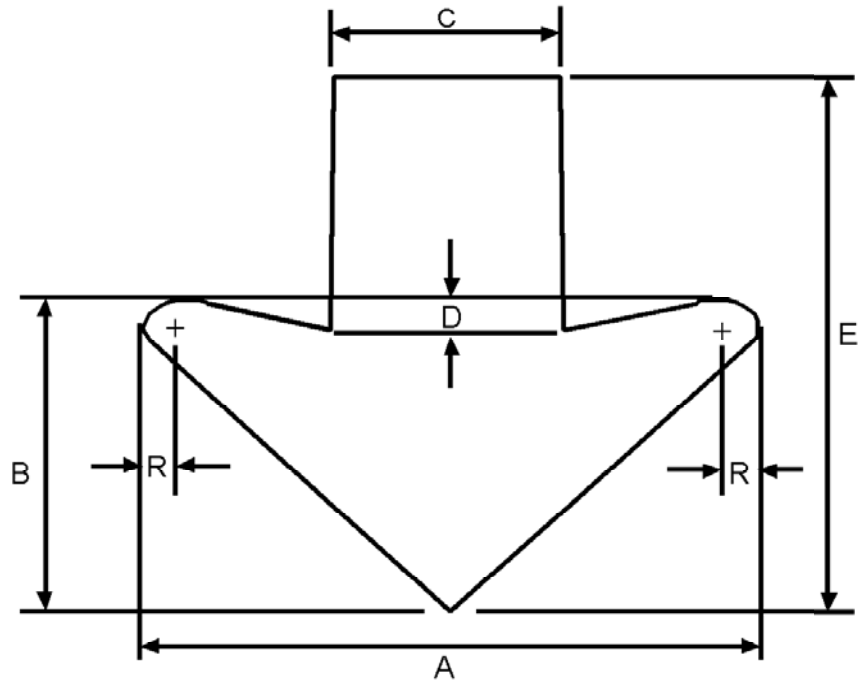

DIMENSION IN INCHES					
A	B	C	D	E	R
22 1/2	11 1/4	5	2 1/4	16 1/2	3/4
32	16	6 1/2	3	22	1

Guide Sign Diagonal Tapered Stem Arrow

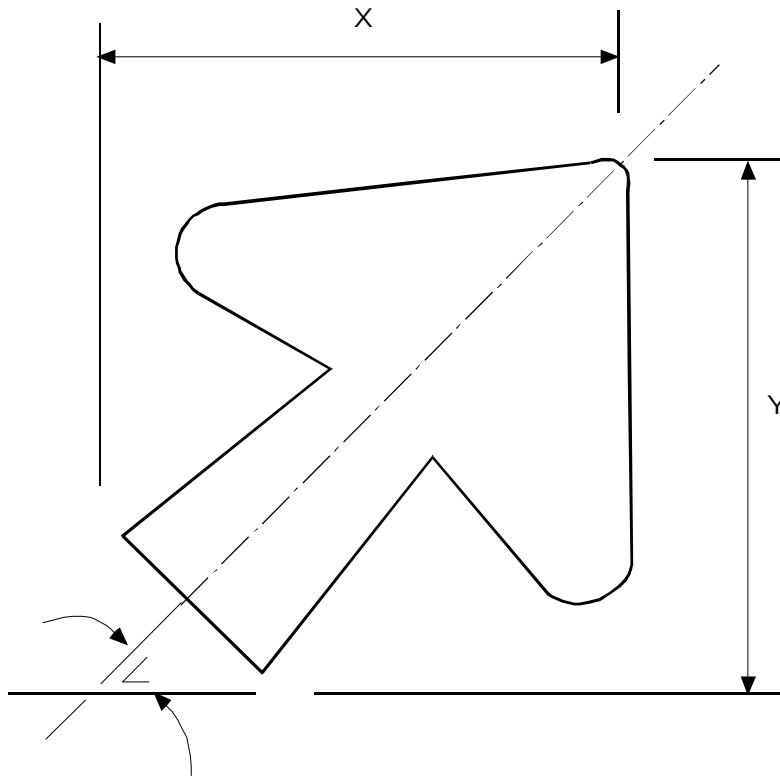

Arrow No.	Dimensions in Inches					
	Angle of Arrow (\angle)					
	30°		45°		60°	
	X	Y	X	Y	X	Y
1	12 1/4	9 7/8	10 7/8	10 7/8	9 7/8	12 1/4
2	16 7/8	12 1/4	14 3/4	14 3/4	12 1/4	16 7/8
3	18 3/4	16	16 3/8	16 3/8	16	18 3/4
4	27 3/4	20 1/4	23 5/8	23 5/8	20 1/4	27 3/4
5	23 1/2	17 3/4	20 1/4	20 1/4	17 3/4	23 1/2
6	32 1/4	22 5/8	27 1/2	27 1/2	22 5/8	32 1/4

Appendix B. Arrows

Guide Sign Advance Turn Arrow

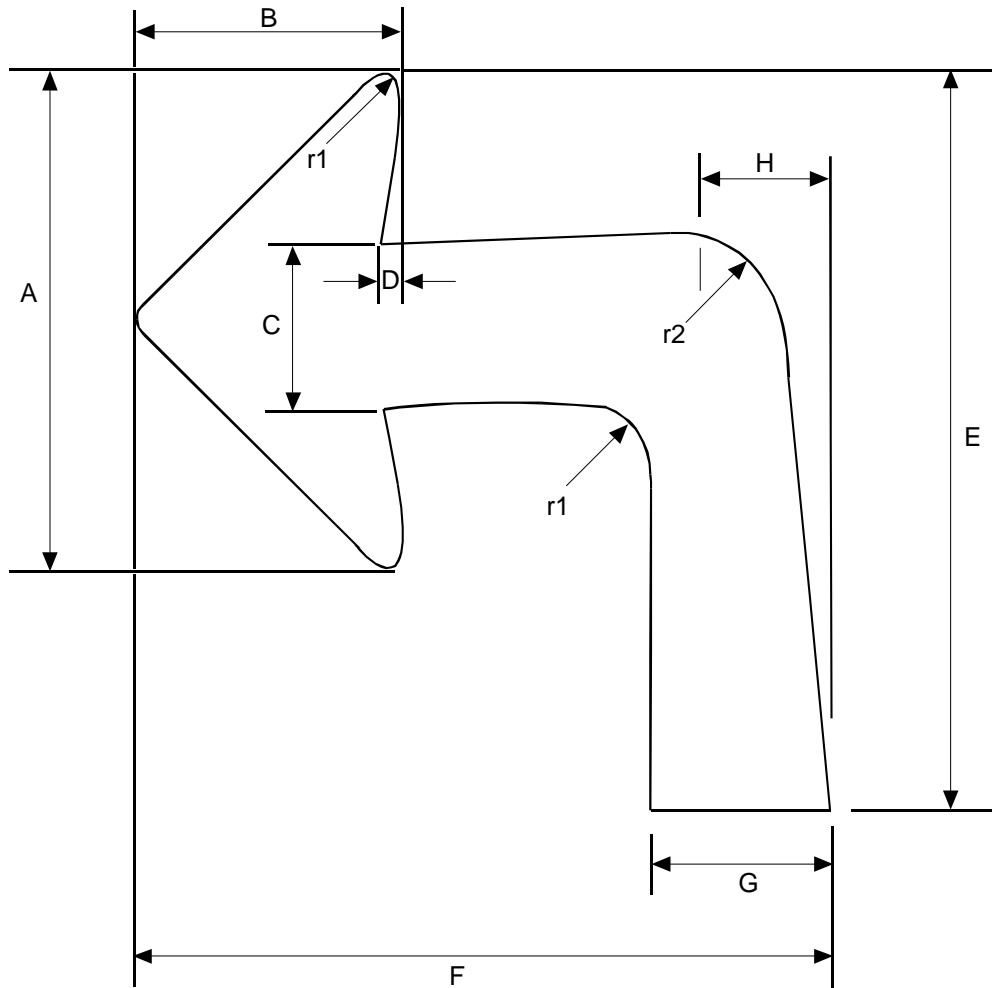

DIMENSIONS IN (INCHES)										
LETTER SIZE	A	B	C	D	E	F	G	H	r1	r2
6 U.C. 4 1/2 L.C.	8 1/2	5 3/4	2	5/8	13 1/2	13	3 1/2	2 1/2	3/8	2
8 U.C. 6 L.C.	14 1/4	9 7/8	3 3/8	1 1/4	17 1/4	17 1/4	5	3 1/2	3/4	2 3/4
10 2/3 U.C. 8 L.C.	18 1/4	14	4 1/2	1 1/2	24	23	6	4	3/4	3

APPENDIX C

C-1 to C-11

Appendix C. Standard Alphabet

Appendix C. Standard Alphabet

Use Federal Highway Administration “Series 2000” typefaces for all signs except the following:

- All green-on-white direction signs (D and E series) except D3-1, D3-1A, and D3-1D, unless marked otherwise.
- D7-1, D7-2, D7-100
- Signs for which the ClearView typeface is specified. (Clearview is specified on sign drawings by appending “-5W” or “-5WR” to the letter height. For example, a 10 inch Clearview typeface would be shown as “10-5W” or 10-5WR”.

Use Clearview 5W typefaces for these signs unless it is critical to minimize sign width, in which case use Clearview 5WR

“Series 2000” typeface shapes and sizes are defined in the “Standard Alphabets” section of the 2004 *Standard Highway Signs* manual (FHWA).

Clearview 5W and 5WR sizes and shapes are defined in the following tables and graphics (obtained from the FHWA Clearview web site). Characters are identical in the 5W and 5WR series – the only difference is the smaller spacing between characters in the 5WR series. The 5W series results in legend widths around 8% wider than the E-modified typeface historically used for guide signs while the 5WR series results in legends 2 – 3% wider. Studies have shown Clearview fonts to be easier to read than traditional highway sign typefaces.

Appendix C. Standard Alphabet

Clearview 5W							
Measurements based on 4 inch upper case letter height-prorate for other heights							
Character	Left Space	Char Width	Right Space	Character	Left Space	Char Width	Right Space
A	0.36	3.76	0.36	o	0.6	3.08	0.6
B	0.8	3.04	0.6	p	0.76	2.92	0.6
C	0.64	3.28	0.44	q	0.6	3.2	0.48
D	0.8	3.24	0.64	r	0.76	1.84	0.4
E	0.8	2.56	0.56	s	0.44	2.56	0.52
F	0.8	2.44	0.52	t	0.36	1.96	0.44
G	0.64	3.48	0.64	u	0.76	2.72	0.76
H	0.8	3.08	0.8	v	0.28	3.04	0.28
I	0.8	0.8	0.8	w	0.32	4.64	0.32
J	0.32	2.24	0.8	x	0.24	3.08	0.24
K	0.8	3.12	0.36	y	0.28	3.12	0.28
L	0.8	2.36	0.48	z	0.48	2.44	0.48
M	0.8	3.68	0.8	1	0.4	1.8	0.8
N	0.8	3.32	0.8	2	0.48	2.76	0.64
O	0.64	3.72	0.64	3	0.44	2.8	0.64
P	0.8	2.92	0.48	4	0.48	3.16	0.52
Q	0.64	3.72	0.64	5	0.6	2.76	0.64
R	0.8	3	0.6	6	0.64	2.92	0.6
S	0.48	2.88	0.52	7	0.4	2.84	0.4
T	0.4	2.88	0.4	8	0.64	2.92	0.64
U	0.8	3.12	0.8	9	0.6	2.92	0.64
V	0.36	3.4	0.36	0	0.68	3.28	0.68
W	0.4	5.32	0.4	&	0.64	3.44	0.4
X	0.32	3.44	0.32	!	0.72	1	0.72
Y	0.28	3.52	0.28	"	0.56	2.16	0.56
Z	0.52	2.88	0.52	#	0.56	3.44	0.56
a	0.52	2.96	0.52	\$	0.48	2.72	0.48
b	0.76	2.88	0.6	¢	0.6	2.6	0.4
c	0.6	2.72	0.4	/	0.44	2.88	0.44
d	0.6	2.92	0.76	*	0.6	1.92	0.6
e	0.6	2.96	0.6	.	0.56	1	0.56
f	0.44	1.92	0.4	,	0.52	1.08	0.52
g	0.6	2.92	0.76	:	0.56	1	0.56
h	0.76	2.76	0.76	(0.6	1.08	0.6
i	0.68	0.92	0.68)	0.6	1.08	0.6
j	-0.12	1.76	0.68	-	0.8	1.56	0.8
k	0.76	2.84	0.28	@	0.64	4.04	0.64
l	0.76	1.28	0.44	=	0.72	2.4	0.72
m	0.76	4.52	0.76	+	0.6	2.68	0.6
n	0.76	2.76	0.76	?	0.56	2.56	0.56

Appendix C. Standard Alphabet

Clearview 5WR							
Measurements based on 4 inch upper case letter height-prorate for other heights							
Character	Left Space	Char Width	Right Space	Character	Left Space	Char Width	Right Space
A	0.24	3.76	0.24	o	0.48	3.08	0.48
B	0.68	3.04	0.48	p	0.64	2.92	0.48
C	0.52	3.28	0.32	q	0.48	3.2	0.36
D	0.68	3.24	0.52	r	0.64	1.84	0.28
E	0.68	2.56	0.44	s	0.28	2.56	0.4
F	0.68	2.44	0.4	t	0.24	1.96	0.36
G	0.52	3.48	0.52	u	0.64	2.72	0.64
H	0.8	3.08	0.8	v	0.16	3.04	0.16
I	0.68	0.8	0.68	w	0.2	4.64	0.2
J	0.2	2.24	0.68	x	0.12	3.08	0.12
K	0.68	3.12	0.24	y	0.16	3.12	0.16
L	0.68	2.36	0.36	z	0.36	2.44	0.36
M	0.68	3.68	0.68	1	0.28	1.8	0.68
N	0.68	3.32	0.68	2	0.36	2.76	0.52
O	0.52	3.72	0.52	3	0.32	2.8	0.52
P	0.68	2.92	0.36	4	0.36	3.16	0.4
Q	0.52	3.72	0.52	5	0.48	2.76	0.52
R	0.68	3	0.48	6	0.52	2.92	0.48
S	0.36	2.88	0.4	7	0.28	2.84	0.28
T	0.28	2.88	0.28	8	0.52	2.92	0.52
U	0.68	3.12	0.68	9	0.48	2.92	0.52
V	0.24	3.4	0.24	0	0.56	3.28	0.56
W	0.28	5.32	0.28	&	0.52	3.44	0.28
X	0.2	3.44	0.2	!	0.6	1	0.6
Y	0.16	3.52	0.16	"	0.44	2.16	0.44
Z	0.4	2.88	0.4	#	0.44	3.44	0.44
a	0.4	2.96	0.4	\$	0.36	2.72	0.36
b	0.64	2.88	0.48	¢	0.48	2.6	0.28
c	0.48	2.72	0.28	/	0.32	2.88	0.32
d	0.48	2.92	0.64	*	0.48	1.92	0.48
e	0.48	2.96	0.48	.	0.44	1	0.44
f	0.32	1.92	0.28	,	0.4	1.08	0.4
g	0.48	2.92	0.64	:	0.44	1	0.44
h	0.64	2.76	0.64	(0.48	1.08	0.48
i	0.56	0.92	0.56)	0.48	1.08	0.48
j	-0.24	1.76	0.56	-	0.6	1.56	0.6
k	0.64	2.84	0.16	@	0.52	4.04	0.52
l	0.64	1.28	0.32	=	0.6	2.4	0.6
m	0.64	4.52	0.64	+	0.48	2.68	0.48
n	0.64	2.76	0.64	?	0.44	2.56	0.44

Appendix C. Standard Alphabet



Appendix C. Standard Alphabet

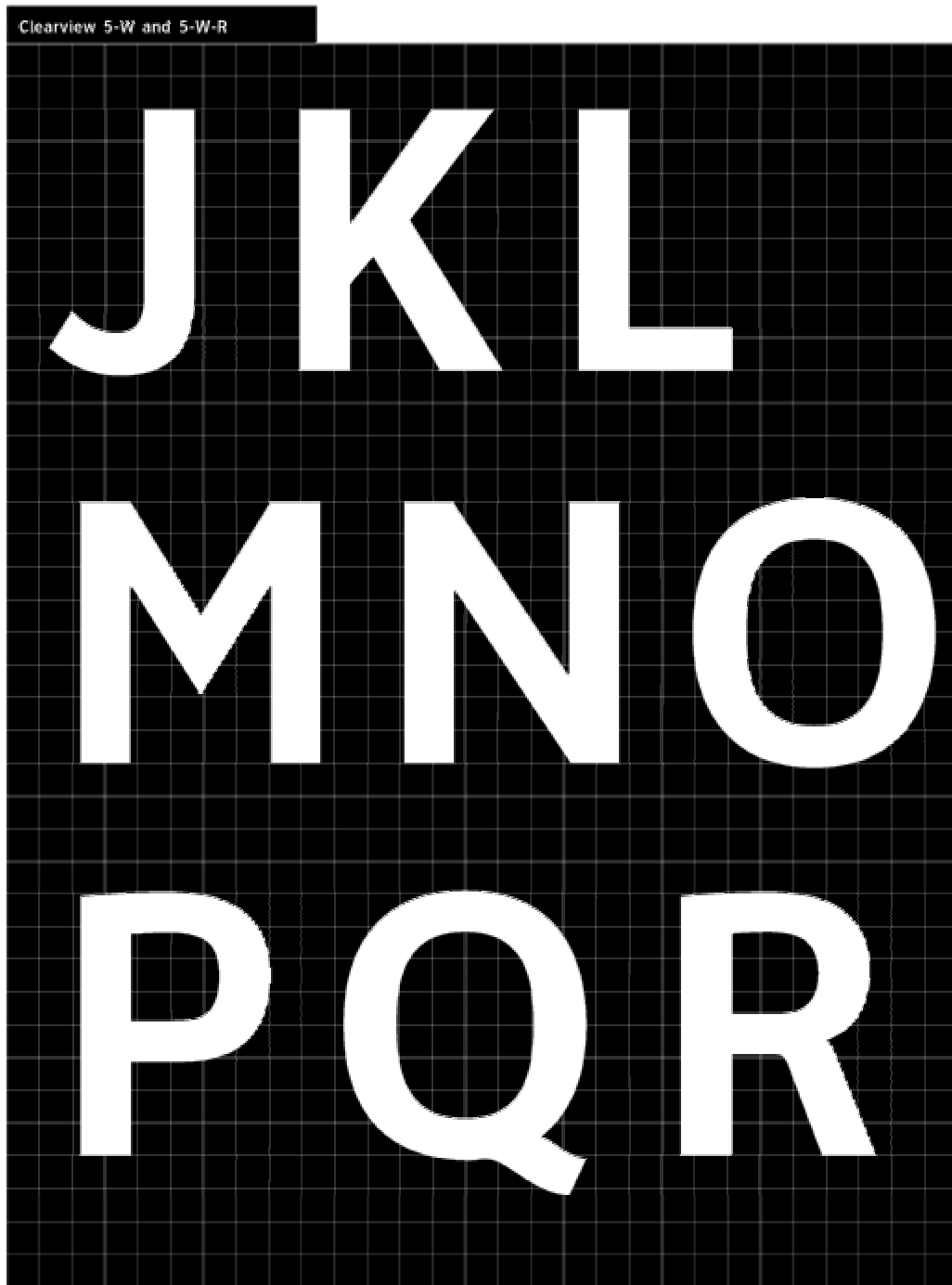

Appendix C. Standard Alphabet

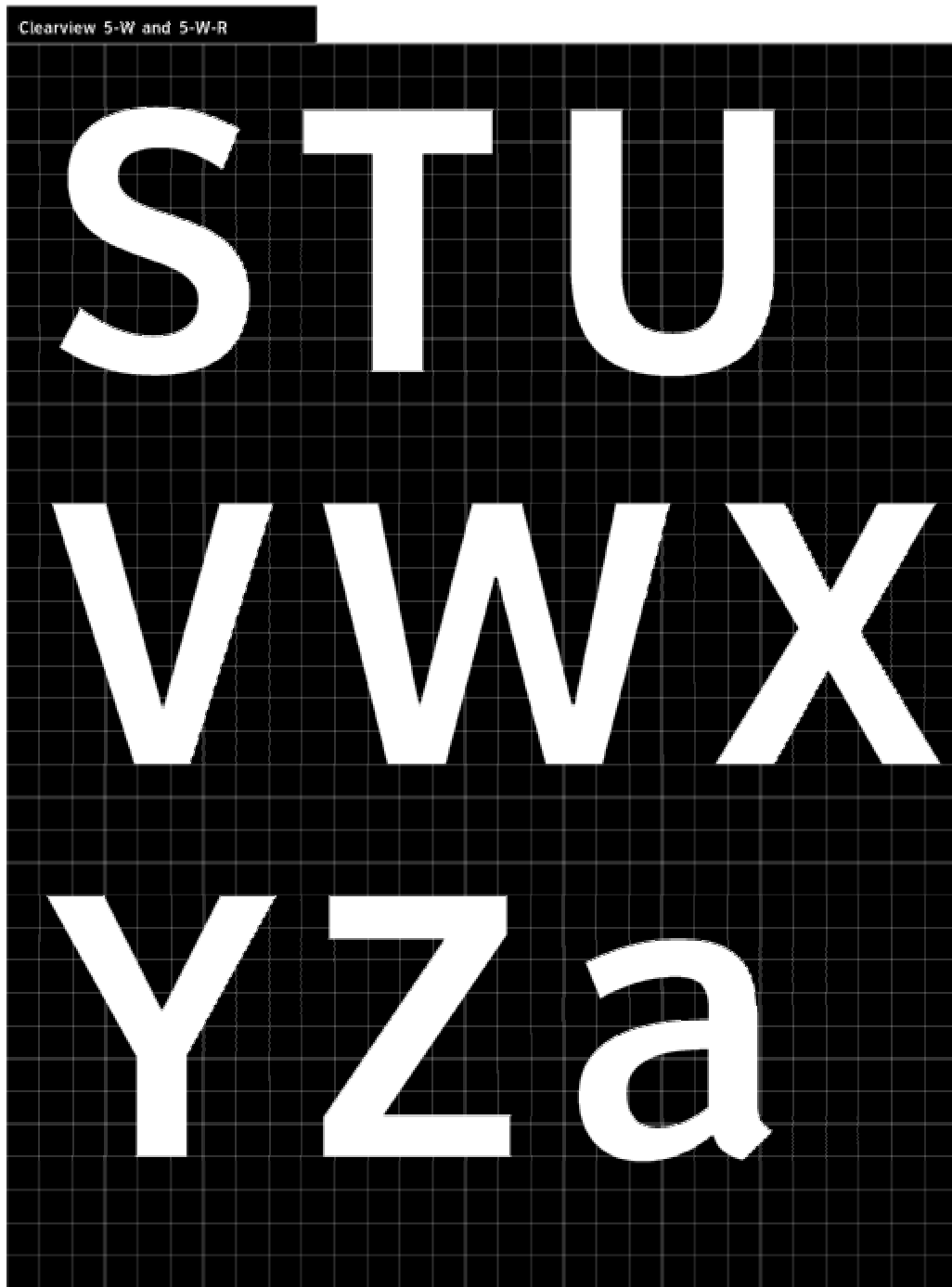

Appendix C. Standard Alphabet



Appendix C. Standard Alphabet



Appendix C. Standard Alphabet

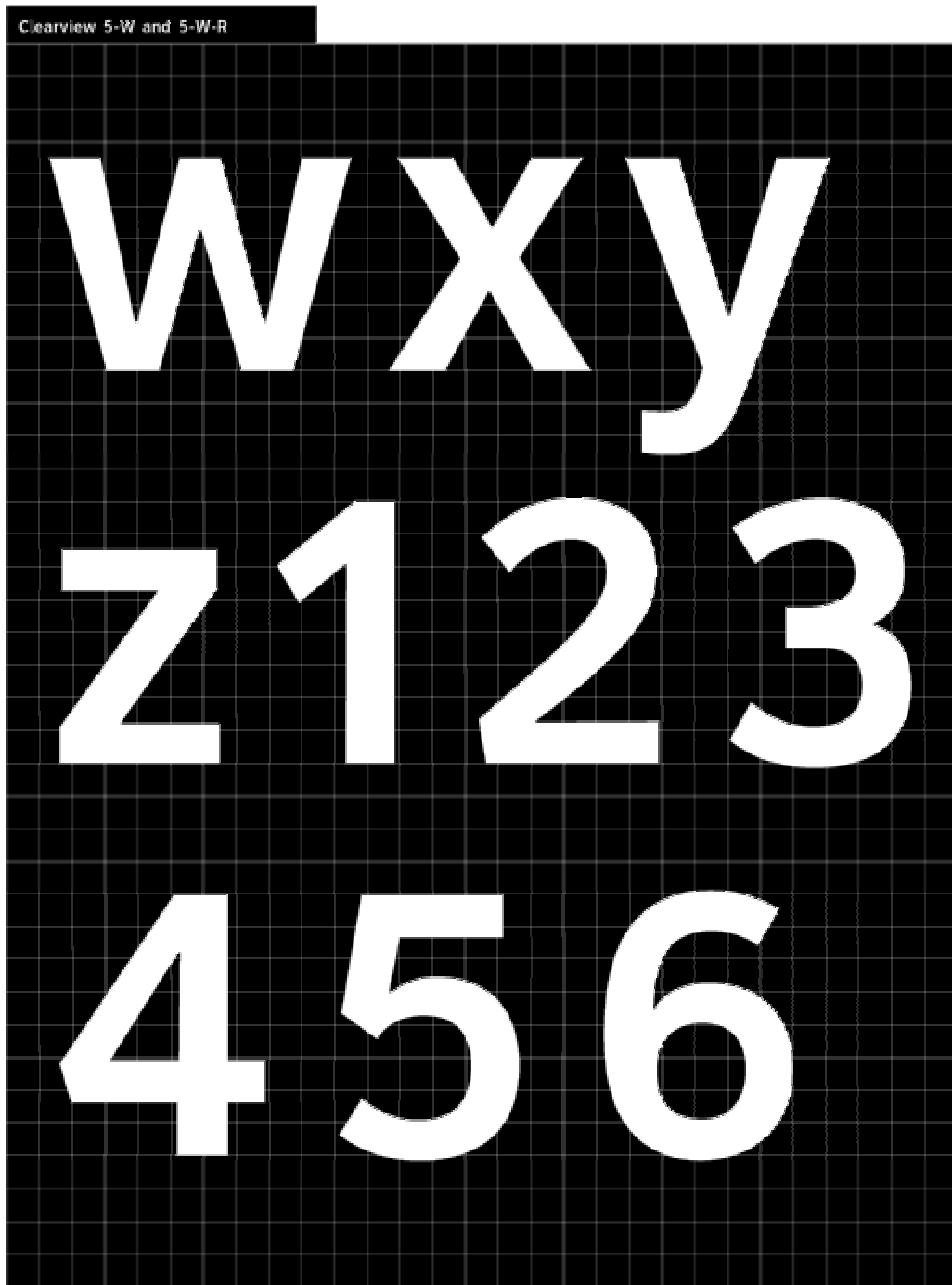

Appendix C. Standard Alphabet

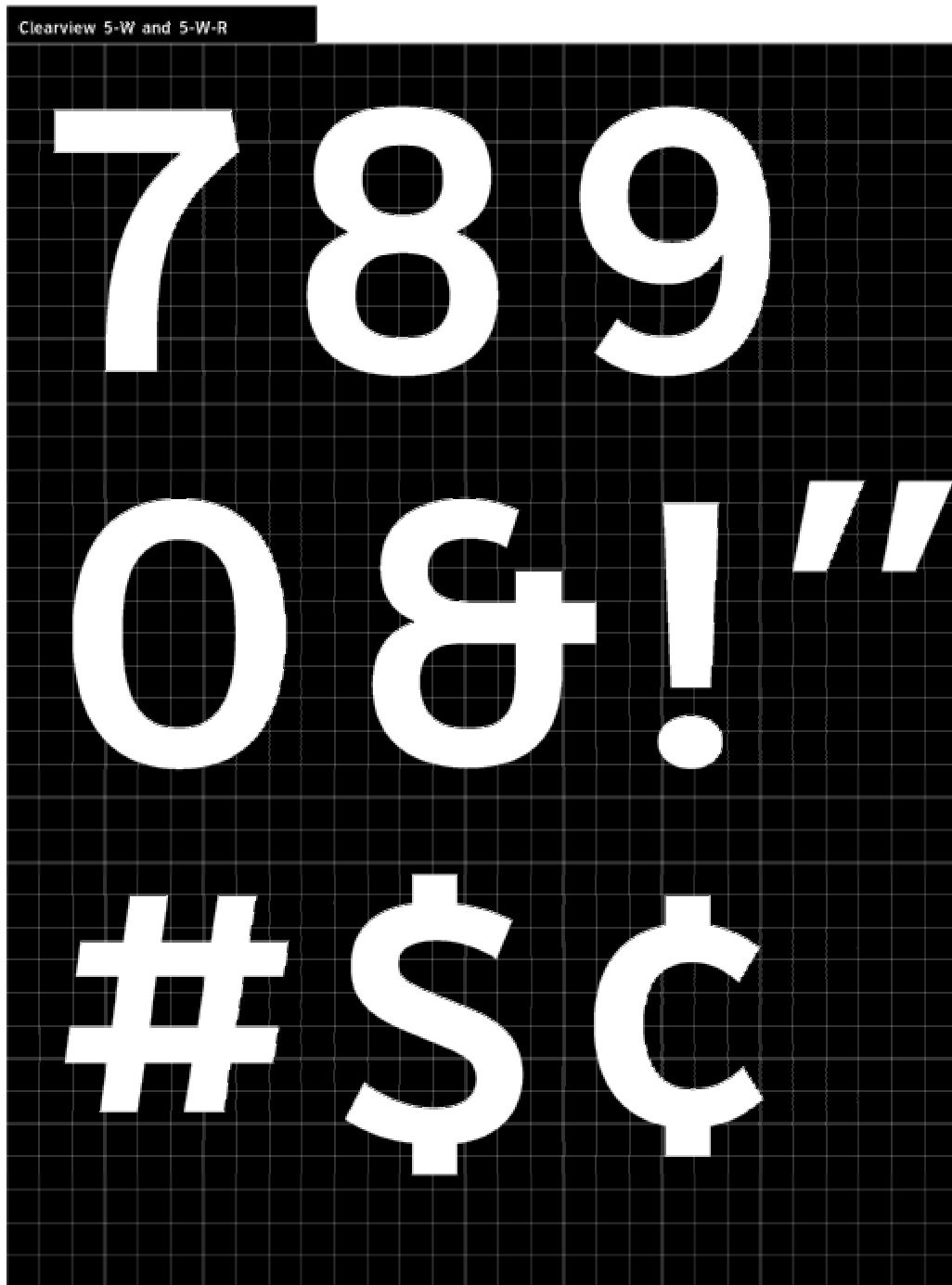

Appendix C. Standard Alphabet

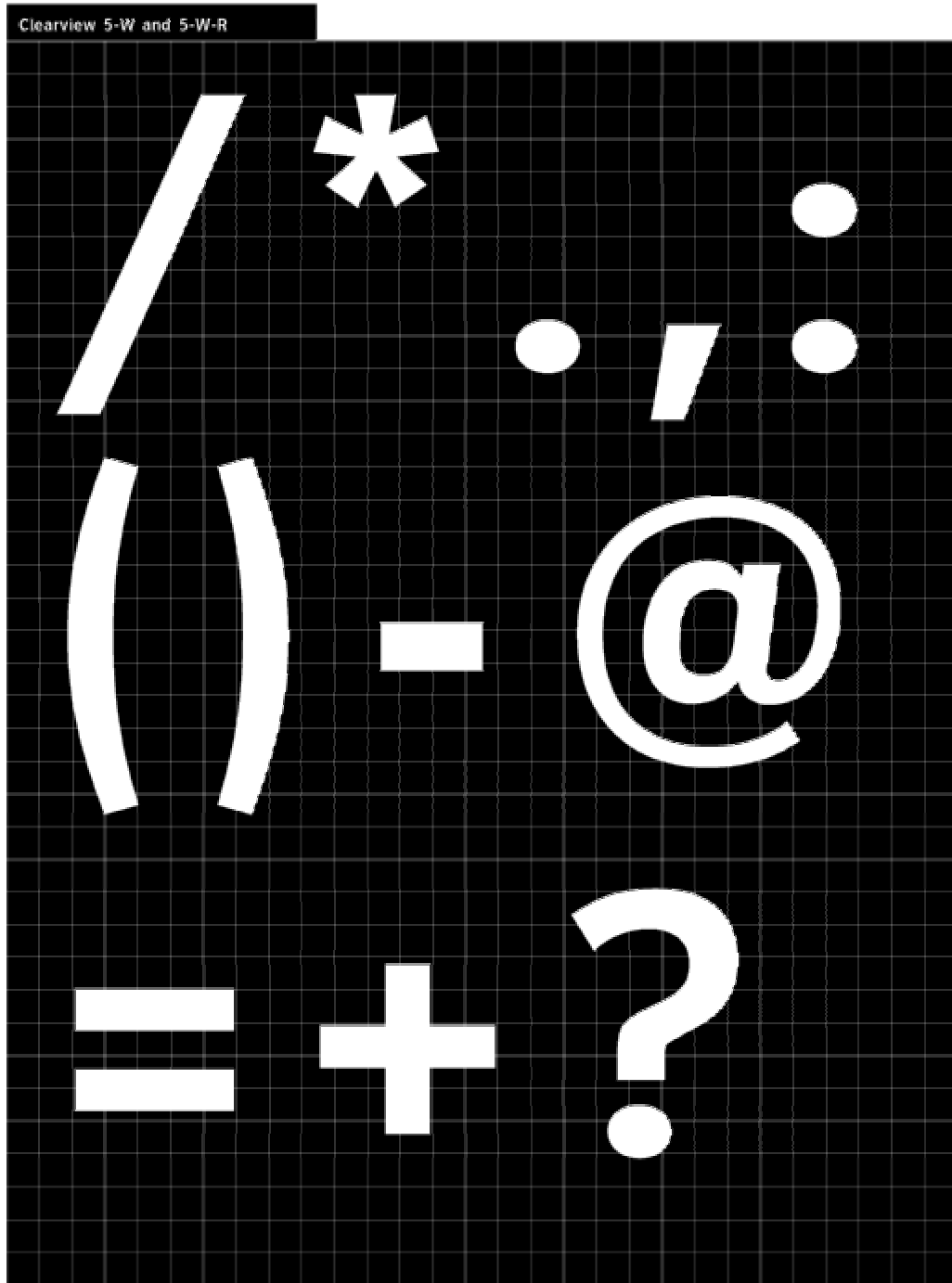

APPENDIX D

D-1 to D-5

Appendix D. Sign Blank Details

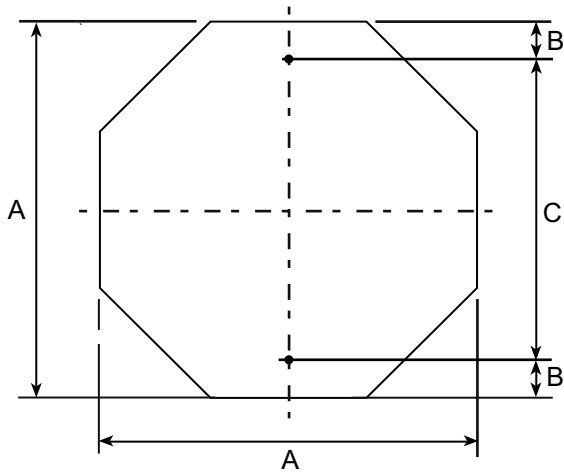

OCTAGON

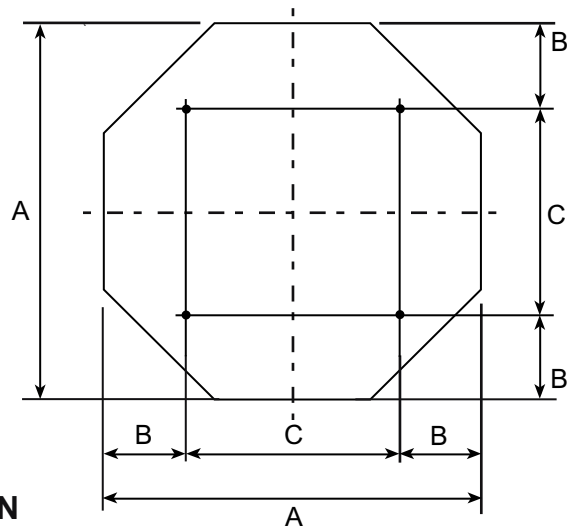

A	B	C
24	3	18
30	3	24
36	3	30

A	B	C
48	9	30

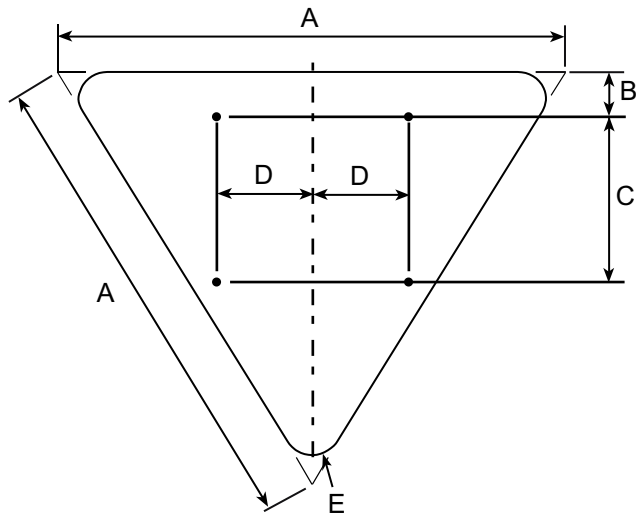
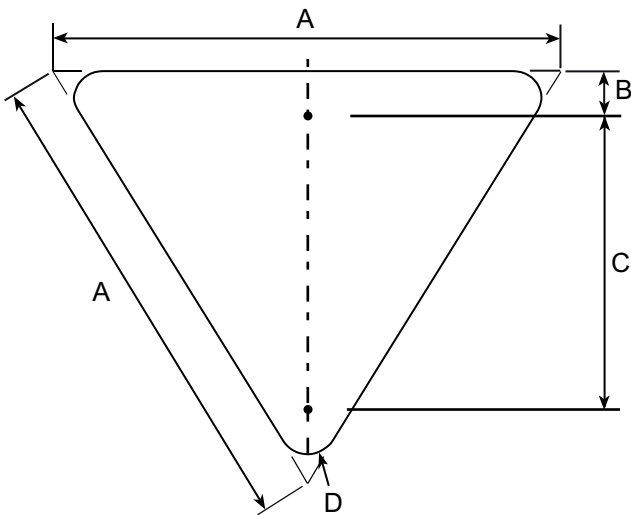

EQUILATERAL TRIANGLE

A	B	C	D
30	3	18	1.5
36	3	21	2.0

A	B	C	D	E
48	3	12	12	3
60	3	18	15	4

Appendix D. Sign Blank Details

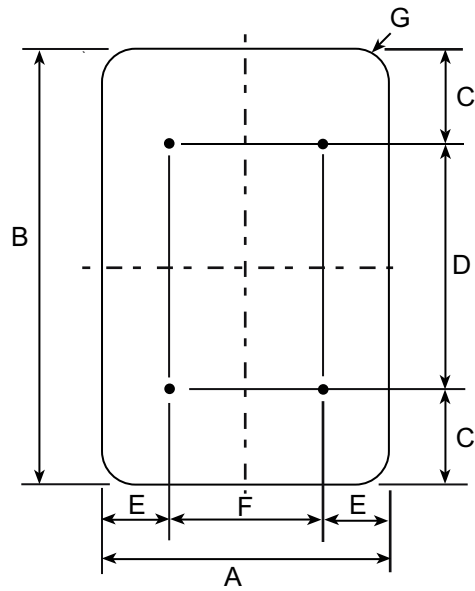
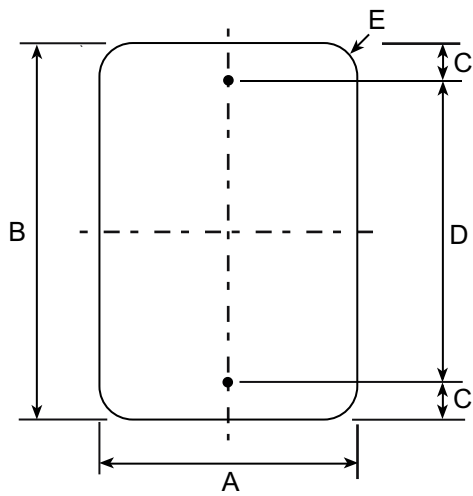

VERTICAL RECTANGLE

A	B	C	D	C
12	18	1.5	15	1.50
18	24	3	18	1.50
24	30	3	24	1.50
30	36	3	30	1.88

A	B	C	D	E	F	G
36	48	6	36	6	24	2.25
48	60	6	48	9	30	3.00

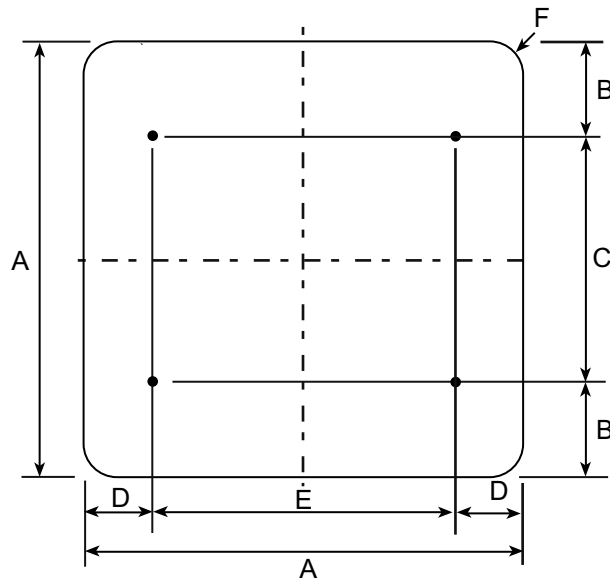
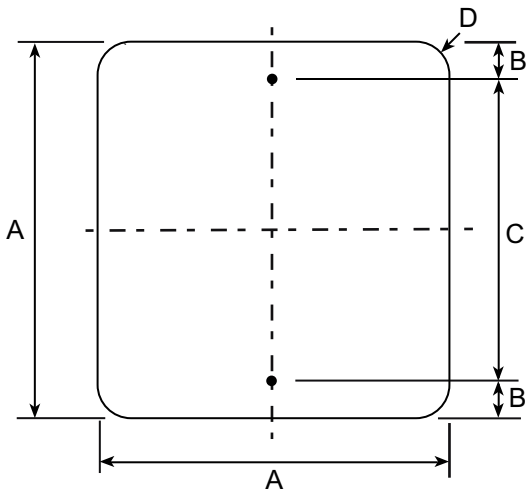

SQUARE

A	B	C	D
18	3	12	1.50
24	3	18	1.50
30	3	24	1.88

A	B	C	D	E	F
36	6	24	6	24	2.25
48	6	36	9	30	3.00

Appendix D. Sign Blank Details

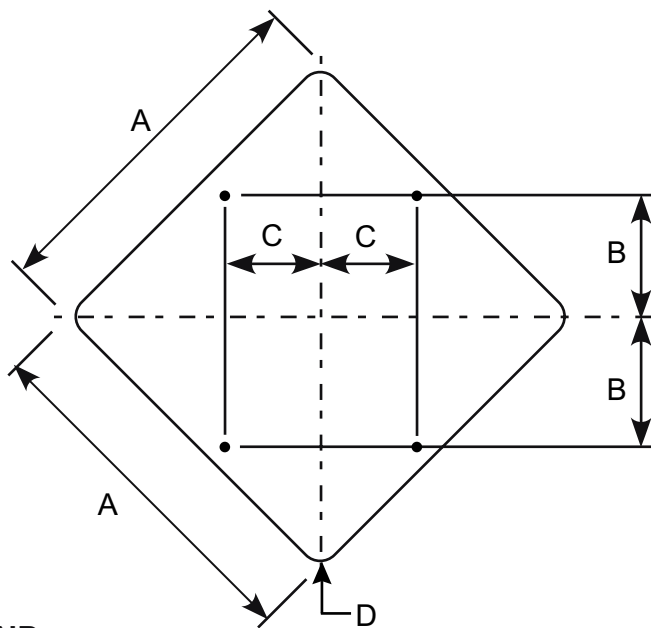
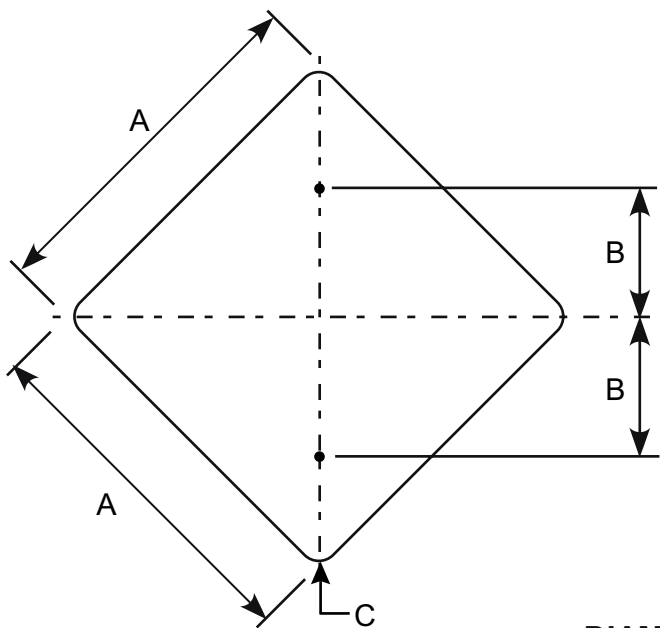

DIAMOND

A	B	C
24	12	1.50
30	15	1.88
36	18	2.25

A	B	C	D
48	15	15	3.00
60	18	18	3.75

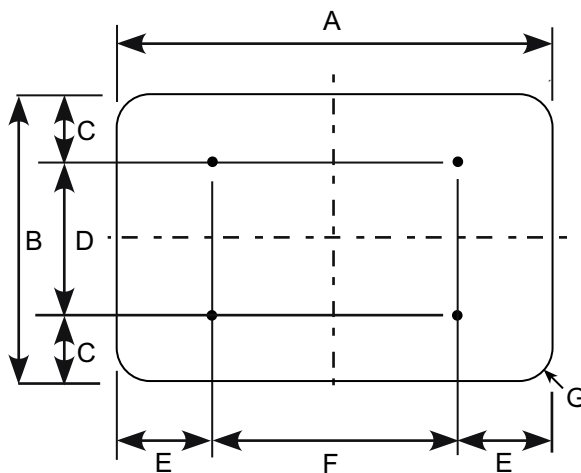
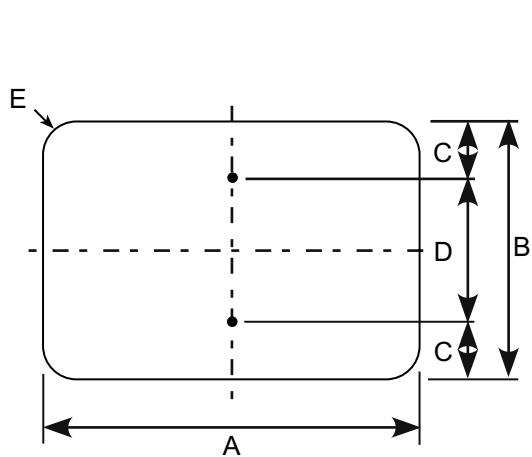

HORIZONTAL RECTANGLE

A	B	C	D	E
21	15	1.5	12	1.5
24	12	1.5	9	1.5
24	18	3.0	12	1.5
30	15	1.5	12	1.5
30	24	3.0	18	1.5
36	12	1.5	9	1.5

A	B	C	D	E	F	G
36	24	3	18	6	24	1.50
48	24	3	18	9	30	1.88
48	36	6	24	9	30	2.25
60	24	3	18	12	36	1.50
60	36	6	24	12	36	2.25

Appendix D. Sign Blank Details

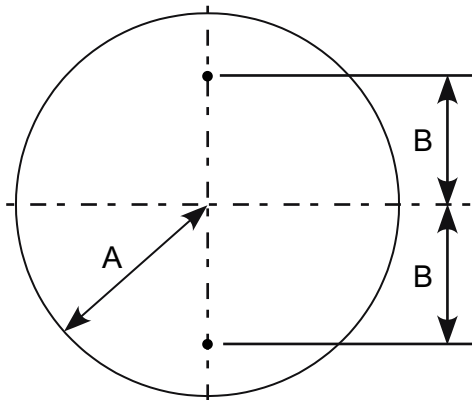

CIRCLE

A	B
15	12
18	15

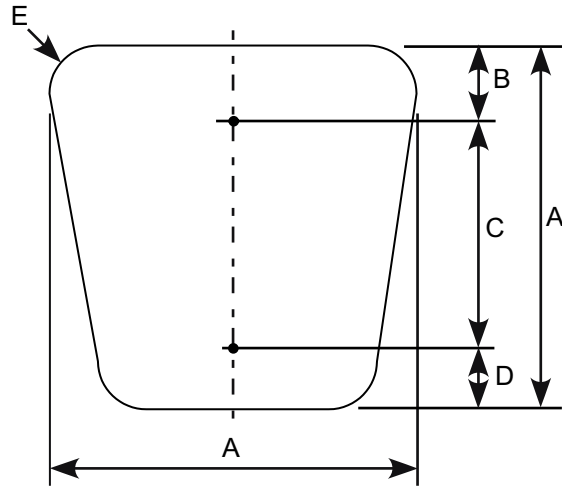

NATIONAL FOREST SHIELD

A	B	C	D	E
18	2.0	15	1.0	2.0
24	2.5	20	1.5	2.5

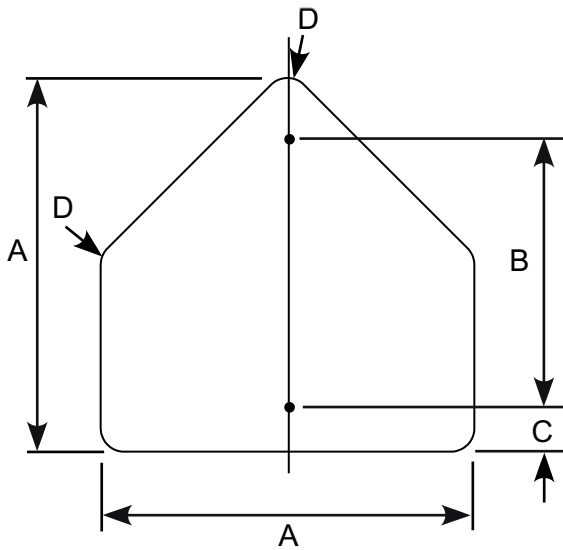

PENTAGON (SCHOOL)

A	B	C	D
30	21	3	1.88
36	24	3	2.25

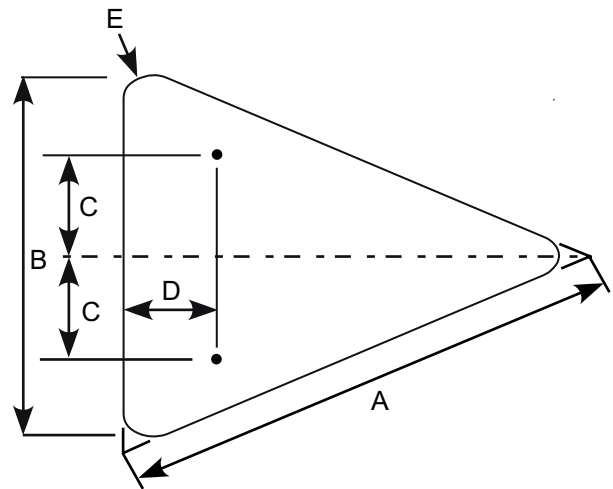

ISOSCELES TRIANGLE

A	B	C	D	E
40	30	7.5	12.0	1.88
48	36	9.0	15.0	2.25
64	48	12.0	20.0	3.00

Appendix D. Sign Blank Details

Standard Highway Sign Border Specifications

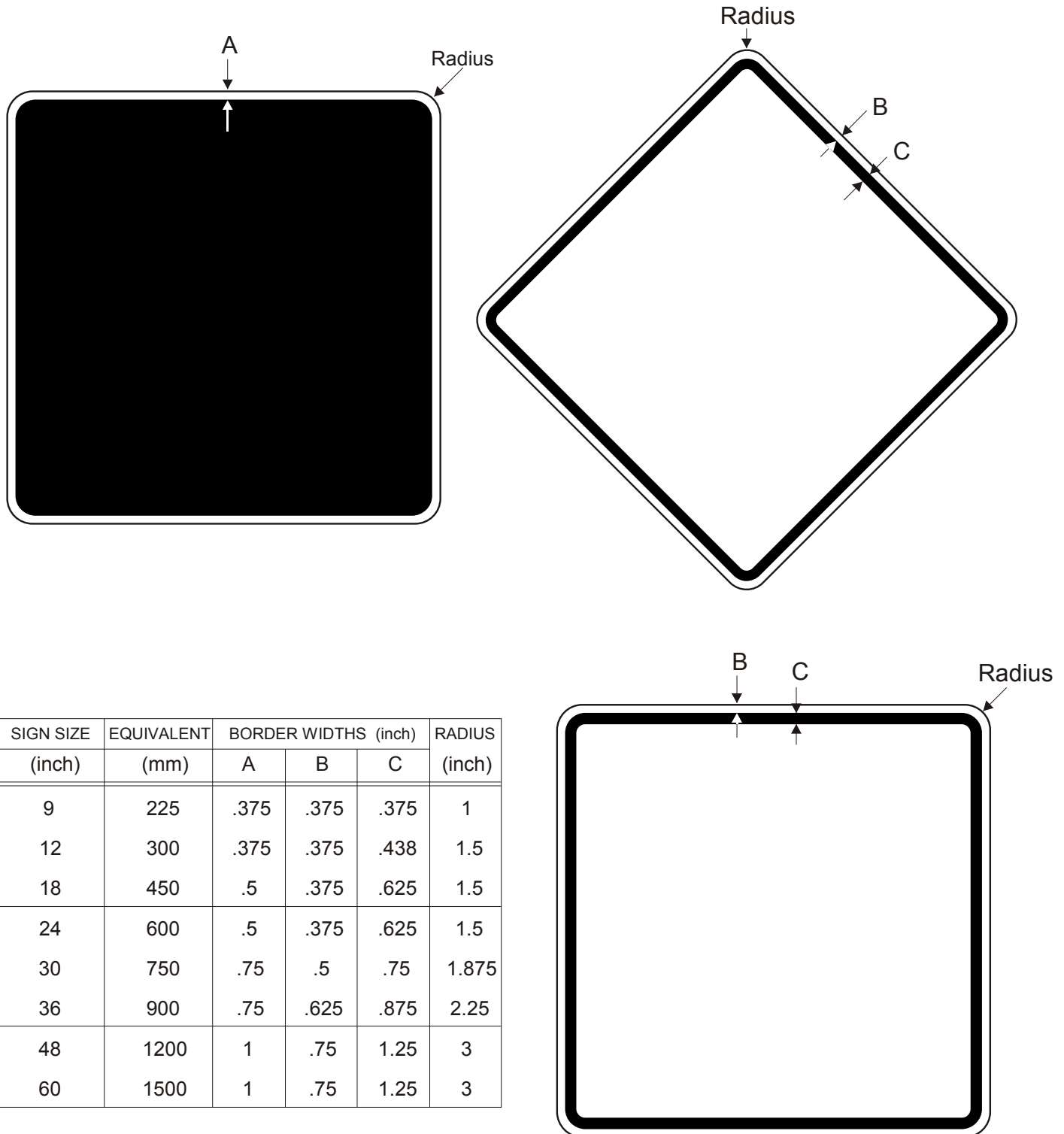

SIGN SIZE (inch)	EQUIVALENT (mm)	BORDER WIDTHS (inch)			RADIUS (inch)
		A	B	C	
9	225	.375	.375	.375	1
12	300	.375	.375	.438	1.5
18	450	.5	.375	.625	1.5
24	600	.5	.375	.625	1.5
30	750	.75	.5	.75	1.875
36	900	.75	.625	.875	2.25
48	1200	1	.75	1.25	3
60	1500	1	.75	1.25	3

